

N2 (UK) Ltd



Veterinary Supplies

UK manufactured 



VETERINARY

Implant Catalogue

for osteosynthesis

Distributor for the Czech and Slovak Republics

MEDCOMPLEX s.r.o.

 <http://www.medcomplex.cz>

 +420 776 270 683

 info@medcomplex.cz

Masty 1, Dobruška 51801
Czech Republic - EU



EV-CMP-24-25-150



Introduction

N2 continue to be an independent UK manufacturer of Implants for the Veterinary and Human markets.

We have been designing, developing and manufacturing Veterinary Implants for 20 years, utilising the latest technology and techniques while still maintaining our strict Human quality controls. Our clientele includes buying groups, individual practises and large distributor networks worldwide. The obvious benefits for the customers is that everything is made 'in house' to ISO standards, with superb customer service and pricing that's hard to beat.

N2 is a streamlined company which does not suffer from demanding shareholders, exorbitant importing costs and restrictions imposed by politics, agendas or industrial disputes.

Our human industry is highly regulated and legally demands we offer the same quality whether the products are used in human or Veterinary markets. The quality remains the same.



Neil (CEO) and
hectic 'Stam'.



Nick and the Late
'Dumpling' Selfie.

N2 are delighted to be able to offer our latest simplified Implant and Instrumentation catalogues and welcome any quotation, questions or ideas that you want to become a reality.

We have included many Implant radiographs, shared some interesting facts and technical data.

We are Nick and Neil (two 'N's, hence N2) the founders of the company. We have 60 years of Engineering experience between us and for the last twenty have been dedicated to Medical Devices both Veterinary and Human. Our broad range of skills and hands on approach have covered most

projects from Formula 1, military and even the dizzy heights of aerospace. We have the physical experience and knowledge of being able to run every process, from concept to manufacturing to make ideas become a reality.

We take great pride in our work and if we really cannot make it, nobody can. Our facilities are fully self-sufficient in every operation and independently audited to human standards. This benefits our customers because we are able to produce bespoke Implants and react quicker to market changes in technology.

Veterinary healthcare is, and always be, our priority.

Neil has a rather boisterous Patterjack called 'Stam' named after his beloved Chelsea Football club's stadium Stamford Bridge.

Nick has three little female domestic short haired tabby cats who are sisters. They are named after the cartoon characters of 'The Powerpuff Girls' (Bubbles, Buttercup and Blossom) he also has several tropical fish.

The Future and Beyond

N2 have now introduced a fuss free demonstration to our products. We do not believe in high pressure sales tactics, tie in obligations and non-transparent pricing.

N2 teams will set up a demonstration with products at your location allowing you to peruse in your own time, as we appreciate your time is valuable and appointments do not always work as planned. The display will feature an array of common products, new additions and free catalogues without someone breathing over your shoulder. We will then collect it after a couple of days and answer any questions there and then or if you prefer we are happy to discuss it through E-mail, telephone, zoom or text. This service is available to all customers large or small and at a time of your choosing.

We have pioneered live shared CAD sessions with clients wanting modifications/ designs while they watch and interact. Take control of your computer mouse and help us develop the future for our animals. This can save time, confusing requirements and manufacturing feasibility.

N2 also offer an open invitation for clients to visit the premises to see where the Implants are actually made and for us to explain the full process and understand the complex manufacturing processes.

We were the first, and continue to freely volunteer our images to the renowned VPOP Planner and our plating templates are also free to download.

N2 and our diverse workforce, continue to grow our business through reputation and recommendation. We are innovative and ground breaking and always raise the bar to make sure we are at the forefront of this amazing industry.



For full terms and conditions please visit our website.

Modern Slavery

While the competition continues to fund unethical and morally questionable Implant suppliers we would like to remind our Customers:

“At N2, transparency is at the heart of what we do. We expect high standards of all our employees. As a result, we do not accept modern slavery in any form. We are committed to respecting human rights. We will not, under any circumstances fund unscrupulous industries”

N2 (UK) Ltd



Veterinary Supplies

Modern Slavery includes:

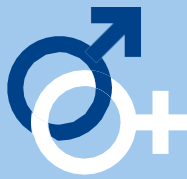

Sexual Exploitation



Criminal Exploitation



Forced Labour



Domestic Servitude

What we can all do

- Question the quality standards of the implants you are buying.
- Question the authenticity of WHERE the implants are actually made.
- Ask for material test certificates and manufacturers cleanliness/Inspection documentation.
- Ask to see the manufacturing facilities or Customs declarations.
- Buying questionable products promotes crime, human trafficking and suffering.

‘Not so’ common Knowledge.

The worldwide veterinary orthopaedic implant market is flooded with suppliers and unscrupulous distributors, but the sad reality is that the market for implants is Unregulated.

No rules, No medical compliance or accountability.

It is illegal to ‘CE’ mark Veterinary implants. The CE mark is only used on Human Certified products.

UK mills in Sheffield, Cardiff or British Steel locations do not make Implantable Stainless Steel for our products in the UK. The specific material for Implants is only available from a limited few manufacturers worldwide including the US and Germany. Common terms like quality 316 Japanese Steel, German Metal, Best quality 316L are a fallacy because only compatible Implantable Steel must conform to ISO (International Standards Organization) 5832-1/3.

Buying the wrong material can result in surgical complications like rust, early Implant failure, infection, amputation and in some cases death.

N2’s Implant do not attract EU tariffs or Duty because they are made in the UK.

N2 actively donates to Worldwide Charities like Street Vet,

Additional N2 customer benefits

We are happy to discuss that 'Extra' Service for our Customers

- Fixed Term Pricing
- Cross Referencing for competitors codes
- Bespoke Plate Design
- Generous Discount Structures
- Loan Kits
- Payment Plans to suit all Budgets
- Training Videos on our YouTube Channel.

N2 at Trade Shows

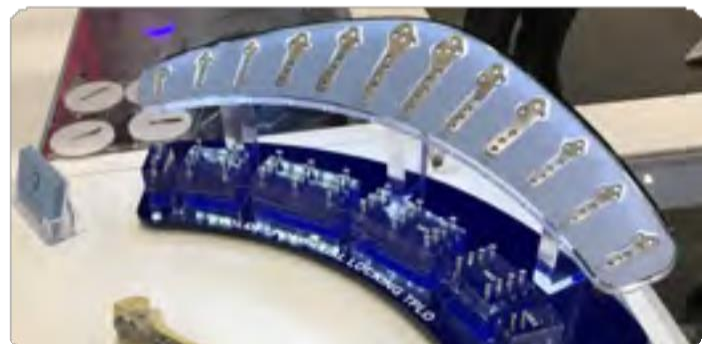

For full terms and conditions please visit our website.



High Quality

- ✓ Products are manufactured from certified medical grade materials
- ✓ Products are manufactured under an ISO quality management system
- ✓ Products are finished and laser identified
- ✓ Products are inspected to ISO:2859-1
- ✓ Products are cleaned and passivated ready for sterilisation
- ✓ Bioburden tests are carried out to ensure a low CFU (colony forming unit) count is maintained



Held by Global Orthopaedics UK Ltd.

Value for money

- ✓ Having control of both facilities enables us to produce cost-effective batch runs and keep stock levels to an economic level
- ✓ Manufacturing under ISO9001 quality management system ensures that continual process improvements are achieved
- ✓ Latest technology, machining strategies and tooling advancements have enabled us to maintain an extremely competitive pricing structure through improved manufacturing times
- ✓ More importantly we believe in charging fair prices and not just replicating competitors prices, which would often result in overcharging



Green Partnership

- ✓ Made in the UK reducing our Carbon Footprint
- ✓ Documentation can be paper free and electronic is the preferred choice.
- ✓ We use no animal by-products.
- ✓ Machining strategies and tool coatings help reduce the power requirements of machine tools.
- ✓ Automation and night time running reduces energy and labour costs of around 50%
- ✓ LED lighting and timers.
- ✓ Bio degradable cleaning products.
- ✓ Wooden transport boxes and pallets are recycled.
- ✓ Oil, metal and carbide recycling



New Products

We continue to innovate in the market, constantly bringing out new products to improve surgeons' choices. A few new products you will find in this copy are

- Hybrid Locking Screws
- RP Tplo Plate Range
- 'Fat Dog 3.5mm Tplo Plate
- Cannulated Locking Plugs
- Compression/Locking Combination Plates
- Dual Direction Compression/Locking Plates
- Antebrachial Locking Plates
- Evolox® Partial Carpal Arthrodesis Plates
- 2.0mm Locking T-Plates
- Evolox® Pancarpal Arthrodesis Plates
- Evolox® Distal Radius Plates
- Evolox® Supracondylar Plates

Unique Custom Plates

Not all orthopaedic cases can be solved by utilising our extensive range of products. Sometimes it calls for something totally unique. We offer, exclusively to our partner network, a bespoke service for custom plates at preferable prices and quick delivery (usually within 2 weeks).

Below are some of our case studies that we were proud to have been involved with.





Contents

	Page
Company Information	2 - 7
Screws	9 - 32
Drills and Taps	33 - 42
Wires and Pins	43 - 50
Bone Plates	51 - 112
Locking Plates (mono-axial)	113-126
Evolox® Locking System	128 - 163
RP (Rory Paton) TPLO Plates	164 - 166
Tibial Tuberosity Advancement (TTA)	167 - 172
Choices and Preferential Options	173
Index	174 - 180

Orientační ceny pro rok 2023 jsou uvedeny v katalogu v měně GBP.

Pro aktuální ceny v CZK nebo EUR nás prosím kontaktujte.

Medcomplex s.r.o.

All photographs and text appearing are the exclusive property of N2 UK Limited and are protected under international copyright laws.

Photographs may not be reproduced, copied, stored, or manipulated in any form without the written permission of N2 UK Limited and/or the respective photographer. This includes use of any image as part of another photographic concept or illustration. No photograph or image or any part of this catalogue is within public domain under section 17 Copyright, Design & Patents Act, 1988.



Screws





	Page
Torx Drive Locking Screws	14
Hex Drive Locking Screws	15
Hybrid Locking Screws	16
Locking Plugs	16
Cannulated Locking Plugs	17
1.5mm Cortical Screws (1.5 Hex)	19
2.0mm Cortical Screws (Various Drives)	19
2.4mm Self Tapping Cortical Screws (Various Drives)	20
2.7mm Cortical Screws (Various Drives)	21
3.5mm Cortical Screws (Various Drives)	22
4.5mm Cortical Screws	23
Cancellous Screws	24
Suture Anchor Screws	25
Suture Anchor Pins (Self tapping)	26
Titanium Screws	27
Titanium Cortical Screws	28
TTA Screws (Cruciform Drive) Low profile	29
IOHC (Incomplete ossification of the humeral condyle)	31
Headless Lag Screws	32



Cut out this page to use for reference



Standard Screws, Locking Screws, Drill Bits and Taps

For full terms and conditions please visit our website.

Screw Diameter (mm)

Thread Diameter	1.5	2.0	2.4	2.7	3.5	4.5	5.5	3.0	4.0	1.5/2.0	2.0	2.0/2.4	2.4	2.7	2.7/3.5	3.5
Screw Type	Cortical							Cancellous		Locking Head						
								Full thread	Partial thread	Compatible with 2mm Locking Plates		Compatible with 2.4mm Locking Plates			Compatible with 2.7mm Locking Plates	Compatible with 3.5mm Locking Plates

Drill bit and Tap Diameter (mm)

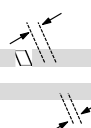
Drill Bit for Gliding Hole	1.5	2.0	2.4	2.7	3.5	4.5	5.5	3.0	4.0	2.5							
																	
Drill Bit for Pilot hole	1.1	1.5	1.8	2.0	2.5	3.2	4.0	2.0	2.0	2.5	1.1	1.5	1.5	1.8	2.0	2.0	
Tap	HA 1.5	HA 2.0	HA 2.4	HA 2.7	HA 3.5	HA 4.5	HA 5.5		HB 4.0		HA 1.5	LC 2.0	LC 2.0	LC 2.4	LC 2.7	LC 2.7	
Drive Type	1.5mm Hex	1.5mm Hex Cruciate Slot Recess	1.5mm Hex 2.0 Hex 2.0 Hex Cruciate Recess T8	2.5mm Hex Cruciate Recess T8/T15		3.5mm Hex		2.5mm Hex	2.5mm Hex		T6	T6	T8	1.5mm Hex T8	1.5mm Hex T8	2.5mm Hex	2.5mm Hex T15

Orthopaedic Bone Screws

Our raw material is made in either the US or Germany because, contrary to popular belief, no medical steel for our Implants are made in Sheffield, Cardiff or any British Steel locations.



Our manufacturing facilities are capable of not only producing standard tight tolerance medical thread forms but tapered threads, elongated threads and a mixture of thread geometries. We have full CNC (Computer numerical control) on each part produced. N2 also produce our own Bone Taps using harder Implantable materials ensuring full compatibility with our screws and the reputable competitors.

Our most common Self Tapping Cortical Screws have a choice of Hex Drive, Star Torx Drive or Cruciform. All of our screws are made using latest CNC Swiss Turning technology and equal in standards as the Human Market. Our Self Tapping Screws always have the cutting flutes brushed with diamond impregnated wheels keeping them sharp and burr free. The flutes are angled away rather than scalloped which is proven to evacuate debris quicker, reduced clogging and more intact.





We only use raw materials from Europe or America which are fully certified to the latest ISO specifications and fully tested for strength, hardness and chemically analyzed prior to manufacturing. A test certificate for every batch is always available on request.

All of our Implants are periodically tested for bio burden contaminants to ensure our manufacturing processes meet stringent quality standards.

A Visual Image of the thread forms

HC Thread Form		Locking
HA Thread Form		Cortical
HB Thread Form		Cancellous

Look for the following symbols for your choice of driver.

Hexagonal Drive	
Star Torx drive (TD)	
Cruciform (SD)	
Single Slot	

A simple guide to screw identification and ordering

- COR = Cortical Screw
- CAN = Cancellous

- LOC = Locking
- ST = Self Tapping

Order Code explained

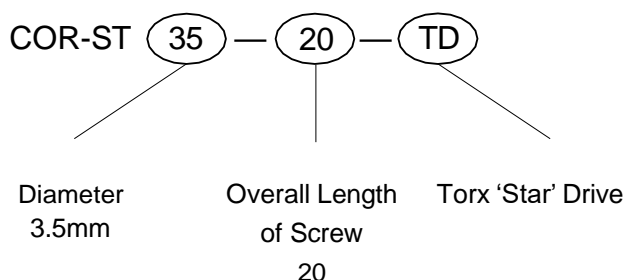

We offer a range of Locking screws with Torx and Hex Head options

The drive angle is the primary driving force behind why a Torx screw is able to handle more torque before cam out (head rounding off). A hex screw relies on a 60 degree angle while the Torx bit relies on a 15 degree angle.

The significantly smaller drive angle forms a much tighter tolerance, which better distributes the concentration of force to all points and therefore allows for much higher torque values before rounding out.

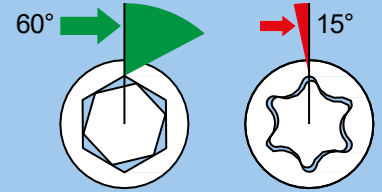

Locking Screw Data

Torx

Screw Size	1520mm	2.0mm	2024mm	2.4mm	2.7mm	3.5mm
Thread Diameter	2.0mm	2.0mm	2.0mm	2.4mm	2.7mm	3.5mm
Thread Form	HC	HC	HC	HC	HC	HC
Thread Pitch (A)	0.6mm	0.6mm	0.6mm	0.6mm	0.6mm	0.8mm
Torx Drive Socket (B)	T6	T6	T8	T8	T8	T15
Head Diameter (C)	2.8mm	2.8mm	3.5mm	3.5mm	2.8mm	5.0mm
Core Diameter	1.1mm	1.4mm	1.4mm	1.8mm	2.0mm	2.7mm
Head Pitch	0.6mm	0.6mm	0.6mm	0.6mm	0.6mm	0.8mm
Drill Bit for Pilot Hole	1.1mm	1.5mm	1.5mm	1.8mm	2.0mm	2.7mm
Drill bit for Threaded Hole	1.5mm	2.0mm	2.0mm	2.4mm	2.7mm	3.5mm
Compatible Plate Sizes	2.0mm	2.0mm	2.4/2.7mm	2.4/2.7mm	2.4/2.7mm	3.5mm

Hex

Screw Size	2.4mm	2.7mm	3.5mm
Thread Diameter	2.4mm	2.7mm	3.5mm
Thread Form	HC	HC	HC
Thread Pitch (A)	0.6mm	0.6mm	0.8mm
Hex Drive Socket (B)	1.5mm	1.5mm	2.5mm
Head Diameter (C)	3.5mm	2.8mm	5.0mm
Core Diameter	1.8mm	2.0mm	2.7mm
Head Pitch	0.6mm	0.6mm	0.8mm
Drill Bit for Pilot Hole	1.8mm	2.0mm	2.7mm
Drill bit for Threaded Hole	2.4mm	2.7mm	3.5mm
Compatible Plate Sizes	2.4/2.7mm	2.4/2.7mm	3.5mm

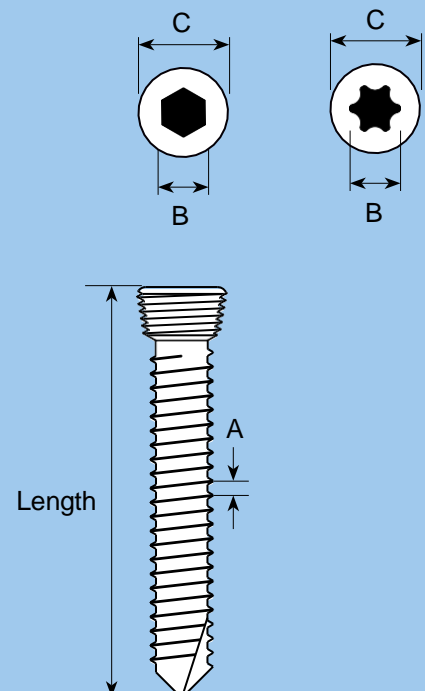



Torx Drive Locking Screws

Length	2.0mm Locking Drive T6 Torx 1.5mm Pilot Drill		2.4mm Locking Drive T8 Torx 1.8mm Pilot Drill		2.7mm Locking Drive T8 Torx 2.0mm Pilot Drill		3.5mm Locking Drive T15 Torx 2.7mm Pilot Drill	
	Code	RRP	Code	Code	Code	RRP		
6	LOC-20-06-TD	£12.20	LOC-24-06-TD	LOC-27-06-TD	-	£11.00		
7	LOC-20-07-TD	£12.35	-	-	-	-		
8	LOC-20-08-TD	£12.50	LOC-24-08-TD	LOC-27-08-TD	-	£11.30		
9	LOC-20-09-TD	£12.55	-	-	-	-		
10	LOC-20-10-TD	£12.80	LOC-24-10-TD	LOC-27-10-TD	LOC-35-10-TD	£11.60		
11	LOC-20-11-TD	£12.95	-	-	-	-		
12	LOC-20-12-TD	£13.10	LOC-24-12-TD	LOC-27-12-TD	LOC-35-12-TD	£11.90		
14	LOC-20-14-TD	£13.40	LOC-24-14-TD	LOC-27-14-TD	LOC-35-14-TD	£12.20		
16	LOC-20-16-TD	£13.70	LOC-24-16-TD	LOC-27-16-TD	LOC-35-16-TD	£12.50		
18	LOC-20-18-TD	£14.00	LOC-24-18-TD	LOC-27-18-TD	LOC-35-18-TD	£12.80		
20	LOC-20-20-TD	£14.30	LOC-24-20-TD	LOC-27-20-TD	LOC-35-20-TD	£13.10		
22	LOC-20-22-TD	£14.60	LOC-24-22-TD	LOC-27-22-TD	LOC-35-22-TD	£13.40		
24	LOC-20-24-TD	£14.90	LOC-24-24-TD	LOC-27-24-TD	LOC-35-24-TD	£13.70		
26	LOC-20-26-TD	£15.20	LOC-24-26-TD	LOC-27-26-TD	LOC-35-26-TD	£14.00		
28	LOC-20-28-TD	£15.50	LOC-24-28-TD	LOC-27-28-TD	LOC-35-28-TD	£14.30		
30	LOC-20-30-TD	£15.80	LOC-24-30-TD	LOC-27-30-TD	LOC-35-30-TD	£14.60		
32	-	-	LOC-24-32-TD	LOC-27-32-TD	LOC-35-32-TD	£14.90		
34	-	-	LOC-24-34-TD	LOC-27-34-TD	LOC-35-34-TD	£15.20		
36	-	-	LOC-24-36-TD	LOC-27-36-TD	LOC-35-36-TD	£15.50		
38	-	-	LOC-24-38-TD	LOC-27-38-TD	LOC-35-38-TD	£15.80		
40	-	-	LOC-24-40-TD	LOC-27-40-TD	LOC-35-40-TD	£16.10		
42	-	-	-	-	LOC-35-42-TD	£16.40		
44	-	-	-	-	LOC-35-44-TD	£16.80		
45	-	-	-	LOC-27-45-TD	LOC-35-45-TD	£17.00		
46	-	-	-	-	LOC-35-46-TD	£17.20		
48	-	-	-	-	LOC-35-48-TD	£17.60		
50	-	-	-	LOC-27-50-TD	LOC-35-50-TD	£18.00		
52	-	-	-	-	LOC-35-52-TD	£18.40		
54	-	-	-	-	LOC-35-54-TD	£18.80		
55	-	-	-	-	LOC-35-55-TD	£19.00		
56	-	-	-	-	LOC-35-56-TD	£19.20		
58	-	-	-	-	LOC-35-58-TD	£19.60		
60	-	-	-	-	LOC-35-60-TD	£20.00		

Hex Drive Locking Screws

Length	2.4mm Locking 1.5mm Hex 1.8mm Pilot Drill Code	2.7mm Locking 2.5mm Hex 2.0mm Pilot Drill Code	3.5mm Locking 2.5mm Hex 2.7mm Pilot Drill Code	RRP
6	LOC-24-06	LOC-27-06	-	£11.00
8	LOC-24-08	LOC-27-08	-	£11.30
10	LOC-24-10	LOC-27-10	LOC-35-10	£11.60
12	LOC-24-12	LOC-27-12	LOC-35-12	£11.90
14	LOC-24-14	LOC-27-14	LOC-35-14	£12.20
16	LOC-24-16	LOC-27-16	LOC-35-16	£12.50
18	LOC-24-18	LOC-27-18	LOC-35-18	£12.80
20	LOC-24-20	LOC-27-20	LOC-35-20	£13.10
22	LOC-24-22	LOC-27-22	LOC-35-22	£13.40
24	LOC-24-24	LOC-27-24	LOC-35-24	£13.70
26	LOC-24-26	LOC-27-26	LOC-35-26	£14.00
28	LOC-24-28	LOC-27-28	LOC-35-28	£14.30
30	LOC-24-30	LOC-27-30	LOC-35-30	£14.60
32	LOC-24-32	LOC-27-32	LOC-35-32	£14.90
34	LOC-24-34	LOC-27-34	LOC-35-34	£15.20
36	LOC-24-36	LOC-27-36	LOC-35-36	£15.50
38	LOC-24-38	LOC-27-38	LOC-35-38	£15.80
40	LOC-24-40	LOC-27-40	LOC-35-40	£16.10
42	-	-	LOC-35-42	£16.40
44	-	-	LOC-35-44	£16.80
45	-	LOC-27-45	LOC-35-45	£17.00
46	-	-	LOC-35-46	£17.20
48	-	-	LOC-35-48	£17.60
50	-	LOC-27-50	LOC-35-50	£18.00
52	-	-	LOC-35-52	£18.40
54	-	-	LOC-35-54	£18.80
55	-	-	LOC-35-55	£19.00
56	-	-	LOC-35-56	£19.20
58	-	-	LOC-35-58	£19.60
60	-	-	LOC-35-60	£20.00



Veterinary Supplies

We are proud to also offer two hybrid screw options. The 1520 and the 2024. We believe this gives our customers more choice than others in screw selection and planning options.

The 1520 has a 2.0mm screw head with a 1.5mm screw shaft, ideal for very small bones or bone fragments. These will fit in all our 2.0mm Locking plates.

The 2024 range follows a similar idea but has a 2.0mm shaft and fits in all our 2.4mm and 2.7mm polyaxial and monoaxial locking plates.

Hybrid Locking Screws

Length	Hybrid 15 20 Drive T6 Torx 1.1mm Pilot Drill		Hybrid 20 24 Drive T8 Torx 1.5mm Pilot Drill	
	Code	RRP	Code	RRP
6	LOC-1520-06-TD	£15.00	LOC-2024-06-TD	£12.20
7	-	-	LOC-2024-07-TD	£12.35
8	LOC-1520-08-TD	£15.00	LOC-2024-08-TD	£12.50
9	-	-	LOC-2024-09-TD	£12.55
10	LOC-1520-10-TD	£15.00	LOC-2024-10-TD	£12.80
11	-	-	LOC-2024-11-TD	£12.95
12	LOC-1520-12-TD	£15.00	LOC-2024-12-TD	£13.10
14	LOC-1520-14-TD	£15.00	LOC-2024-14-TD	£13.40
16	LOC-1520-16-TD	£15.00	LOC-2024-16-TD	£13.70
18	LOC-1520-18-TD	£15.00	LOC-2024-18-TD	£14.00
20	LOC-1520-20-TD	£15.00	LOC-2024-20-TD	£14.30
22	-	-	LOC-2024-22-TD	£14.60
24	-	-	LOC-2024-24-TD	£14.90
26	-	-	LOC-2024-26-TD	£15.20
28	-	-	LOC-2024-28-TD	£15.50
30	-	-	LOC-2024-30-TD	£15.80

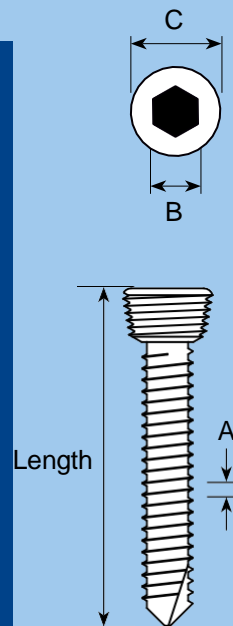

Locking Plugs

Code	Description	Fits Plate	Drive	RRP
LOC-2724-P	2.7/2.4mm Locking Plug	2.4/2.7	Hex 1.5	£8.00
LOC-35-P	3.5mm Locking Plug	3.5	Hex 2.5	£8.00
LOC-20-PTD	2.0mm Locking Plug	2.0	Torx T6	£8.00
LOC-2724-PTD	2.7/2.4mm Locking Plug	2.4/2.7	Torx T8	£8.00
LOC-35-PTD	3.5mm Locking Plug	3.5	Torx T15	£8.00



Cannulated Locking Plugs

The Cannulated plugs are particularly useful as a way of holding the plates in situ whilst the other holes are drilled and filled. Reduces the need for bone holding forceps which can sometimes be hard to locate without interfering with the surgeon's working area.

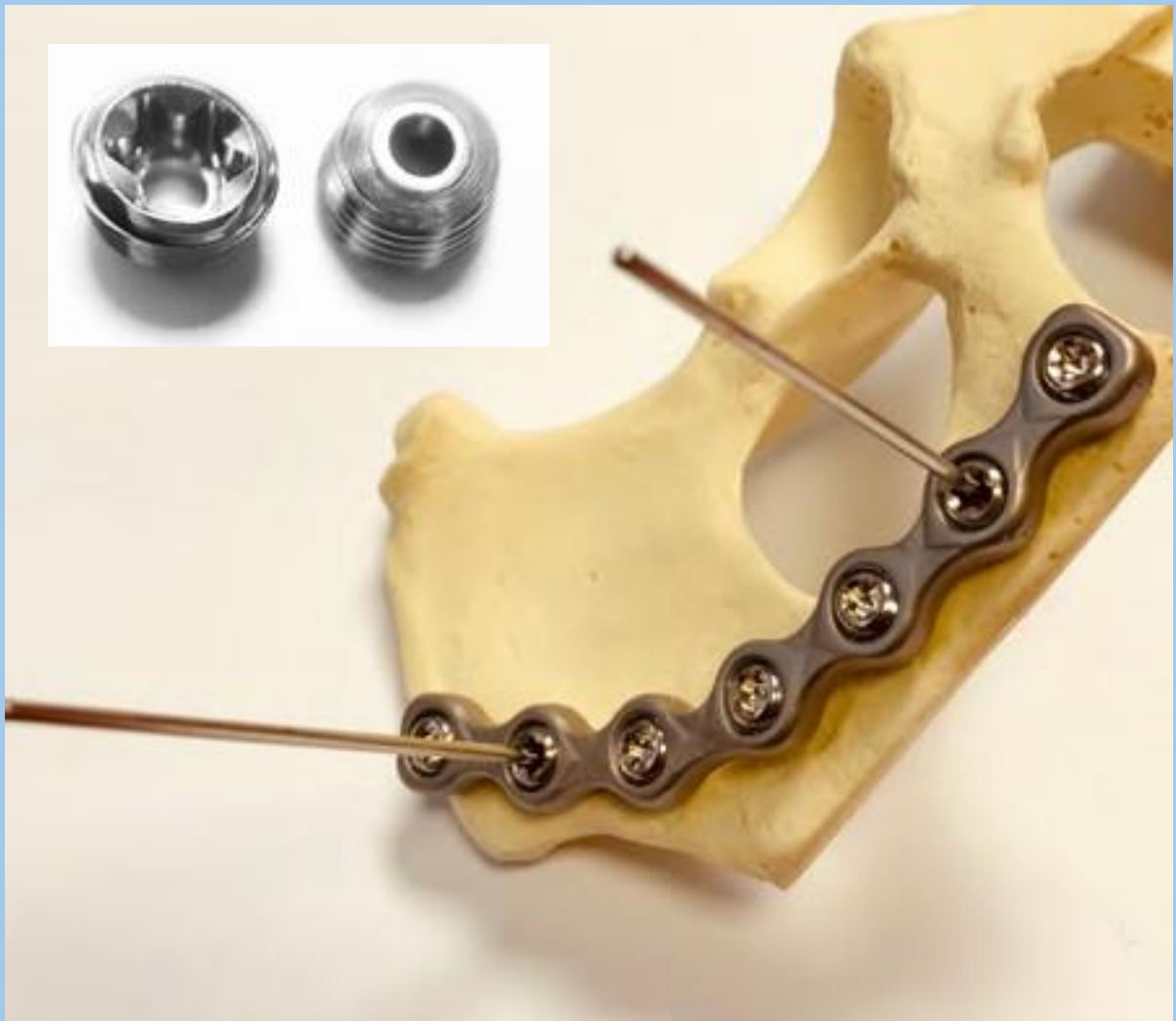

Code	Description	Fits Plate	Drive	RRP
LOC-20-P-TDC	2.0mm Locking Plug. Cannulated 1.1mm (use 1.0mm guide wire)	2.0	Torx T6	£10.00
LOC-2724-P-TDC	2.7/2.4mm Locking Plug. Cannulated 1.6mm (use 1.4mm guide wire)	2.4/2.7	Torx T8	£10.00
LOC-35-P-TDC	3.5mm Locking Plug. Cannulated 1.6mm (use 1.4mm guide wire)	3.5	Torx T15	£10.00



Cortical Screws

Cortical Screws are still used widely in the veterinary market, particularly where compression is needed. We offer a large selection of head types with some sizes having Torx Drive, Hex and Cruciform as available options. We also stock Self Tapping and non-Self tapping variants ready for immediate despatch. The Quality of our screws hasn't changed over the years and it's an area often overlooked by others as being as important as the plate used to ensure a solid construct.

Cortical Screws Hex Head

	1.5mm	2.0mm	2.4mm	2.7mm	3.5mm	4.5mm	5.5mm
Thread Diameter	1.5mm	2.0mm	2.4mm	2.7mm	3.5mm	4.5mm	5.5mm
Thread Pitch (A)	0.5mm	0.6mm	1.0mm	1.0mm	1.25mm	1.75mm	2.0mm
Hex Head Size (B)	1.5mm	1.5mm	1.5mm and 2.0mm	2.5mm	2.5mm	3.5mm	3.5mm
Head Diameter (C)	3.0mm	4.0mm	4.0mm	5.0mm	6.0mm	8.0mm	8.0mm
Drill Bit for Pilot Hole	1.1mm	1.5mm	1.8mm	2.0mm	2.5mm	3.2mm	4.0mm
Drill Bit for Gliding Hole	1.5mm	2.0mm	2.4mm	2.7mm	3.5mm	4.5mm	5.5mm
Core Diameter	1.1mm	1.3mm	1.6mm	1.9mm	2.4mm	3.0mm	4.0mm

Cortical Screw Torx (Star) Head

	2.0mm	2.4mm	2.7mm	3.5mm
Thread Diameter	2.0mm	2.4mm	2.7mm	3.5mm
Thread Pitch (A)	0.6mm	1.0mm	1.0mm	1.25mm
Torx Head Size (B)	T6	T8	T8	T15
Head Diameter (C)	4.0mm	4.0mm	5.0mm	6.0mm
Drill Bit for Pilot Hole	1.5mm	1.8mm	2.0mm	2.5mm
Drill Bit for Gliding Hole	2.0mm	2.4mm	2.7mm	3.5mm
Core Diameter	1.3mm	1.6mm	1.9mm	2.4mm

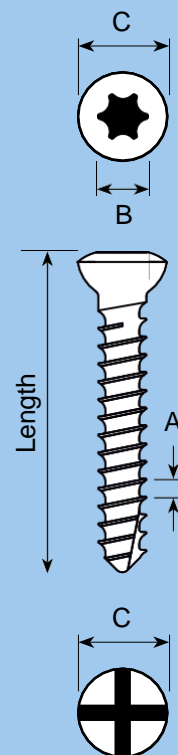

Cortical Screw Cruciform Head

	2.0mm	2.4mm
Thread Diameter	2.0mm	2.4mm
Thread Pitch (A)	0.6mm	1.0mm
Head Diameter (C)	4.0mm	5.0mm
Drill Bit for Pilot Hole	1.5mm	1.8mm
Drill Bit for Gliding Hole	2.0mm	2.4mm
Drill Bit for Gliding Hole	2.0mm	3.5mm
Core Diameter	1.3mm	1.6mm

1.5mm Cortical Screws (1.5 Hex)

Length	Non-Self tapping	Self tapping	RRP
6	COR-1506	COR-ST-1506	£4.30
7	COR-1507	COR-ST-1507	£4.35
8	COR-1508	COR-ST-1508	£4.40
9	COR-1509	COR-ST-1509	£4.45
10	COR-1510	COR-ST-1510	£4.50
11	COR-1511	COR-ST-1511	£4.55
12	COR-1512	COR-ST-1512	£4.60
14	COR-1514	COR-ST-1514	£4.70
16	COR-1516	COR-ST-1516	£4.80
18	COR-1518	COR-ST-1518	£4.90
20	COR-1520	COR-ST-1520	£5.00

2.0mm Cortical Screws (Various Drives)

Length	2.0mm Self Tapping Cortical Screws (Various Drives)				2.0mm Cortical (1.5 Hex)	
	Drive 1.5mm Hex Code	Drive T6 Torx Code	Drive Cruciform Code	RRP	Non-Self tapping Code	RRP
6	COR-ST-2006	COR-ST-2006-TD	-	£4.40	COR-2006	£4.10
7	COR-ST-2007	COR-ST-2007-TD	-	£4.40	-	-
8	COR-ST-2008	COR-ST-2008-TD	COR-ST-2008-CD	£4.50	COR-2008	£4.20
9	COR-ST-2009	COR-ST-2009-TD	-	£4.50	-	-
10	COR-ST-2010	COR-ST-2010-TD	COR-ST-2010-CD	£4.60	COR-2010	£4.30
11	COR-ST-2011	COR-ST-2011-TD	-	£4.60	-	-
12	COR-ST-2012	COR-ST-2012-TD	COR-ST-2012-CD	£4.70	COR-2012	£4.40
14	COR-ST-2014	COR-ST-2014-TD	-	£4.80	COR-2014	£4.50
16	COR-ST-2016	COR-ST-2016-TD	COR-ST-2016-CD	£4.90	COR-2016	£4.60
18	COR-ST-2018	COR-ST-2018-TD	COR-ST-2018-CD	£5.00	COR-2018	£4.70
20	COR-ST-2020	COR-ST-2020-TD	COR-ST-2020-CD	£5.10	COR-2020	£4.80
22	COR-ST-2022	COR-ST-2022-TD	-	£5.20	-	-
24	COR-ST-2024	COR-ST-2024-TD	-	£5.30	-	-
26	COR-ST-2026	COR-ST-2026-TD	-	£5.40	-	-
28	COR-ST-2028	COR-ST-2028-TD	-	£5.50	-	-
30	COR-ST-2030	COR-ST-2030-TD	-	£5.60	-	-

2.4mm Self Tapping Cortical Screws (Various Drives)

Length	Drive 1.5mm Hex	Drive 2.0mm Hex	Drive T8 Torx	Drive Cruciform	RRP
	Code	Code		Code	
6	COR-ST-2406	COR-ST-2406-H2	COR-ST-2406-TD	-	£4.20
8	COR-ST-2408	COR-ST-2408-H2	COR-ST-2408-TD	-	£4.40
10	COR-ST-2410	COR-ST-2410-H2	COR-ST-2410-TD	COR-ST-2410-CD	£4.60
12	COR-ST-2412	COR-ST-2412-H2	COR-ST-2412-TD	COR-ST-2412-CD	£4.80
14	COR-ST-2414	COR-ST-2414-H2	COR-ST-2414-TD	COR-ST-2414-CD	£5.00
16	COR-ST-2416	COR-ST-2416-H2	COR-ST-2416-TD	COR-ST-2416-CD	£5.20
18	COR-ST-2418	COR-ST-2418-H2	COR-ST-2418-TD	COR-ST-2418-CD	£5.40
20	COR-ST-2420	COR-ST-2420-H2	COR-ST-2420-TD	COR-ST-2420-CD	£5.60
22	COR-ST-2422	COR-ST-2422-H2	COR-ST-2422-TD	-	£5.80
24	COR-ST-2424	COR-ST-2424-H2	COR-ST-2424-TD	-	£6.00
26	COR-ST-2426	COR-ST-2426-H2	COR-ST-2426-TD	-	£6.20
28	COR-ST-2428	COR-ST-2428-H2	COR-ST-2428-TD	-	£6.40
30	COR-ST-2430	COR-ST-2430-H2	COR-ST-2430-TD	-	£6.60
32	COR-ST-2432	COR-ST-2432-H2	COR-ST-2432-TD	-	£6.80
34	COR-ST-2434	COR-ST-2434-H2	COR-ST-2434-TD	-	£7.00
36	COR-ST-2436	COR-ST-2436-H2	COR-ST-2436-TD	-	£7.20
38	COR-ST-2438	COR-ST-2438-H2	COR-ST-2438-TD	-	£7.40
40	COR-ST-2440	COR-ST-2440-H2	COR-ST-2440-TD	-	£7.60



2.7mm Cortical Screws (Various Drives)

Length	2.7mm Self Tapping Cortical (various Drives)			2.7mm Cortical (2.5 Hex)	
	Drive 2.5mm Hex	Drive T8 Torx		Non-Self tapping	
	Code	Code	RRP	Code	RRP
6	COR-ST-2706	COR-ST-2706-TD	£3.60	COR-2706	£3.30
8	COR-ST-2708	COR-ST-2708-TD	£3.80	COR-2708	£3.50
10	COR-ST-2710	COR-ST-2710-TD	£4.00	COR-2710	£3.70
12	COR-ST-2712	COR-ST-2712-TD	£4.20	COR-2712	£3.90
14	COR-ST-2714	COR-ST-2714-TD	£4.40	COR-2714	£4.10
16	COR-ST-2716	COR-ST-2716-TD	£4.60	COR-2716	£4.30
18	COR-ST-2718	COR-ST-2718-TD	£4.80	COR-2718	£4.50
20	COR-ST-2720	COR-ST-2720-TD	£5.00	COR-2720	£4.70
22	COR-ST-2722	COR-ST-2722-TD	£5.20	COR-2722	£4.90
24	COR-ST-2724	COR-ST-2724-TD	£5.40	COR-2724	£5.10
26	COR-ST-2726	COR-ST-2726-TD	£5.60	COR-2726	£5.30
28	COR-ST-2728	COR-ST-2728-TD	£5.80	COR-2728	£5.50
30	COR-ST-2730	COR-ST-2730-TD	£6.00	COR-2730	£5.70
32	COR-ST-2732	COR-ST-2732-TD	£6.20	-	-
34	COR-ST-2734	COR-ST-2734-TD	£6.40	-	-
35	COR-ST-2735	COR-ST-2735-TD	£6.60	-	-
36	COR-ST-2736	COR-ST-2736-TD	£6.80	-	-
38	COR-ST-2738	COR-ST-2738-TD	£7.00	-	-
40	COR-ST-2740	COR-ST-2740-TD	£7.20	-	-



3.5mm Cortical Screws (Various Drives)

Length	3.5mm Self Tapping Cortical (various Drives)			3.5mm Cortical (2.5 Hex)	
	Drive 2.5mm Hex Code	Drive T8 Torx Code	RRP	Non-Self tapping Code	RRP
8	COR-ST-3508	COR-ST-3508-TD	£4.40	-	-
10	COR-ST-3510	COR-ST-3510-TD	£4.50	COR-3510	£4.10
12	COR-ST-3512	COR-ST-3512-TD	£4.60	COR-3512	£4.20
14	COR-ST-3514	COR-ST-3514-TD	£4.70	COR-3514	£4.30
16	COR-ST-3516	COR-ST-3516-TD	£4.80	COR-3516	£4.40
18	COR-ST-3518	COR-ST-3518-TD	£4.90	COR-3518	£4.50
20	COR-ST-3520	COR-ST-3520-TD	£5.00	COR-3520	£4.60
22	COR-ST-3522	COR-ST-3522-TD	£5.10	COR-3522	£4.70
24	COR-ST-3524	COR-ST-3524-TD	£5.20	COR-3524	£4.80
26	COR-ST-3526	COR-ST-3526-TD	£5.30	COR-3526	£4.90
28	COR-ST-3528	COR-ST-3528-TD	£5.40	COR-3528	£5.00
30	COR-ST-3530	COR-ST-3530-TD	£5.50	COR-3530	£5.10
32	COR-ST-3532	COR-ST-3532-TD	£5.60	COR-3532	£5.20
34	COR-ST-3534	COR-ST-3534-TD	£5.70	COR-3534	£5.30
35	-	-	-	COR-3535	£5.40
36	COR-ST-3536	COR-ST-3536-TD	£5.90	COR-3536	£5.50
38	COR-ST-3538	COR-ST-3538-TD	£6.00	COR-3538	£5.60
40	COR-ST-3540	COR-ST-3540-TD	£6.10	COR-3540	£5.70
42	COR-ST-3542	COR-ST-3542-TD	£6.20	-	-
44	COR-ST-3544	COR-ST-3544-TD	£6.30	-	-
45	-	-	-	COR-3545	£5.80
46	COR-ST-3546	COR-ST-3546-TD	£6.50	-	-
48	COR-ST-3548	COR-ST-3548-TD	£6.60	-	-
50	COR-ST-3550	COR-ST-3550-TD	£6.70	COR-3550	£5.90
55	COR-ST-3555	COR-ST-3555-TD	£6.80	-	-
60	COR-ST-3560	COR-ST-3560-TD	£6.90	-	-

4.5mm Cortical Screws

Length	4.5mm Cortical (3.5 Hex)		4.5mm Cortical (3.5 Hex)	
	Self Tapping Code	RRP	Non-Self tapping Code	RRP
12	COR-ST-4512	£5.00	-	-
14	COR-ST-4514	£5.10	COR-4514	£4.80
16	COR-ST-4516	£5.20	COR-4516	£4.90
18	COR-ST-4518	£5.30	COR-4518	£5.00
20	COR-ST-4520	£5.40	COR-4520	£5.10
22	COR-ST-4522	£5.50	COR-4522	£5.20
24	COR-ST-4524	£5.60	COR-4524	£5.30
26	COR-ST-4526	£5.70	COR-4526	£5.40
28	COR-ST-4528	£5.80	COR-4528	£5.50
30	COR-ST-4530	£5.90	COR-4530	£5.60
32	COR-ST-4532	£6.00	COR-4532	£5.70
34	COR-ST-4534	£6.10	COR-4534	£5.80
36	COR-ST-4536	£6.20	COR-4536	£5.90
38	COR-ST-4538	£6.30	COR-4538	£6.00
40	COR-ST-4540	£6.40	COR-4540	£6.10
42	COR-ST-4542	£6.50	COR-4542	£6.20
44	COR-ST-4544	£6.60	COR-4544	£6.30
46	COR-ST-4546	£6.70	COR-4546	£6.40
48	COR-ST-4548	£6.80	COR-4548	£6.50
50	COR-ST-4550	£6.90	COR-4550	£6.60
52	COR-ST-4552	£7.00	COR-4552	£6.70
54	COR-ST-4554	£7.10	COR-4554	£6.80
56	COR-ST-4556	£7.20	COR-4556	£6.90
58	COR-ST-4558	£7.30	COR-4558	£7.00
60	COR-ST-4560	£7.40	-	-
62	COR-ST-4562	£7.50	-	-
64	COR-ST-4564	£7.60	-	-
65	COR-ST-4565	£7.70	-	-
66	COR-ST-4566	£7.80	-	-
68	COR-ST-4568	£7.90	-	-
70	COR-ST-4570	£8.00	-	-



Cancellous Screws

These screws have a coarse thread designed to grip in cancellous bone. They are also useful as a rescue screw. i.e your 3.5mm cortical has sheared its head you can remove it and replace with a 4.0mm cancellous.

Cancellous Bone Screw	Ø3.0mm	Ø4.0mm
Hexagonal Thread Diameter	3.0mm	4.0mm
Thread Pitch (A)	1.25mm	1.75mm
Hexagon Socket (B)	2.5mm	2.5mm
Head Diameter (C)	5.0mm	6.0mm
Drill Pilot	2.0mm	2.0mm
Core Diameter	1.9mm	1.9mm

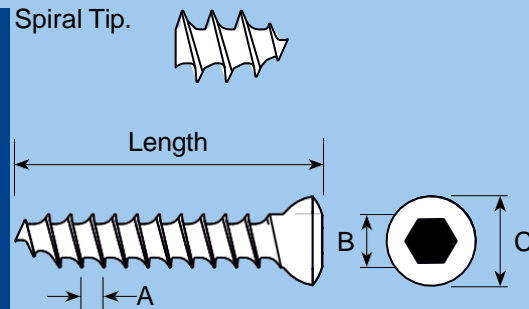

Length	Diameter 3.0mm Full Thread 2.5 Hex Drive 2.0 Pilot Drill		Diameter 4.0mm Full Thread 2.5 Hex Drive 2.0 Pilot Drill		Diameter 4.0mm Part Thread 2.5 Hex Drive 2.0 Pilot Drill	
	Code	RRP	Code	RRP	Code	RRP
12	CAN-FT-3012	£4.20	CAN-FT-4012	£4.40		
14	CAN-FT-3014	£4.40	CAN-FT-4014	£4.60	-	-
16	CAN-FT-3016	£4.50	CAN-FT-4016	£4.80	-	-
18	CAN-FT-3018	£4.60	CAN-FT-4018	£5.00	-	-
20	CAN-FT-3020	£4.80	CAN-FT-4020	£5.20	CAN-PT-4020	£4.80
22	CAN-FT-3022	£4.90	CAN-FT-4022	£5.30	CAN-PT-4022	£4.90
24	CAN-FT-3024	£5.00	CAN-FT-4024	£5.50	CAN-PT-4024	£5.00
26	CAN-FT-3026	£5.10	CAN-FT-4026	£5.70	CAN-PT-4026	£5.20
28	CAN-FT-3028	£5.30	CAN-FT-4028	£5.90	CAN-PT-4028	£5.30
30	CAN-FT-3030	£5.40	CAN-FT-4030	£6.10	CAN-PT-4030	£5.50
32	CAN-FT-3032	£5.50	CAN-FT-4032	£6.30	-	-
34	CAN-FT-3034	£5.60	CAN-FT-4034	£6.50	-	-
35	-	-	CAN-FT-4035	£6.60	CAN-PT-4035	£5.70
36	CAN-FT-3036	£5.80	CAN-FT-4036	£6.80	-	-
38	-	-	CAN-FT-4038	£7.00	-	-
40	-	-	CAN-FT-4040	£7.20	CAN-PT-4040	£6.20
45	-	-	CAN-FT-4045	£7.40	-	-
50	-	-	CAN-FT-4050	£7.60	-	-

We also sell screw extraction trephines - see page 35 of Instrument Catalogue.

Suture Anchor Screws

Standard Self Tapping Screws with an eyed head.

Suture can be passed through the eye securely with the shaft in the bone.

Length	Code	Description	Eyelet Ø	Diameter mm	RRP
6	SA-2006	Suture Anchor Screw Cortical 2mm x 6mm Long	1.5mm	2.0	£15.00
10	SA-2010	Suture Anchor Screw Cortical 2mm x 10mm Long	1.5mm	2.0	£15.00
8	SA-2708	Suture Anchor Screw Cortical 2.7mm x 8mm Long	1.5mm	2.7	£15.00
14	SA-2714	Suture Anchor Screw Cortical 2.7mm x 14mm Long	1.5mm	2.7	£15.00
12	SA-3512	Suture Anchor Screw Cortical 3.5mm x 12mm Long	2.0mm	3.5	£15.00
20	SA-3520	Suture Anchor Screw Cortical 3.5mm x 20mm Long	2.0mm	3.5	£15.00
16	SA-4016	Suture Anchor Screw Cancellous 4.0mm x 16mm Long	2.0mm	4.0	£15.00
24	SA-4024	Suture Anchor Screw Cancellous 4.0mm x 24mm Long	2.0mm	4.0	£15.00

SA-20XX SA-27XX SA-40XX SA-35XX

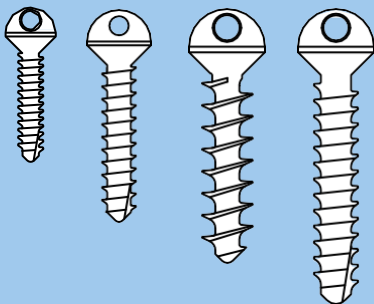

Screwdriver to fit all Suture head screws.

Order Code	Description	RRP
SA-INSERT	Universal Suture Screw Insertion Driver	£65.00

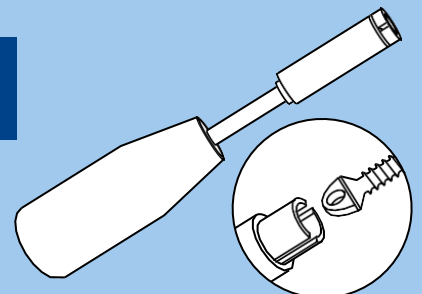

For full terms and conditions please visit our website.

Suture Anchor Pins (Self tapping)

An Ingenious pin for use as a suture anchor.

The tip of the pin has a thread cut into it that can be driven into the bone. Once in position the pin can be bent and will snap at the designated point just above the head, leaving the hole in position to receive the suture line.

Order Code	Diameter	Overall Length	Screw Length	Hole Ø	Pilot Drill	RRP
SSP-27	2.7mm	125mm	14.5mm	1.5	2.0	£15.00
SSP-35	3.5mm	125mm	18mm	1.5	2.5	£15.00
SSP-40	4.0mm	135mm	24mm	2.1	2.7	£15.00

SSP27



SSP35



SSP40



Titanium Screws

Very similar in design to Cortical Screws. Used primarily with TTA implants. Titanium implants are more osteo compatible than stainless steel implants and don't affect MRI scans as much

	2.4mm	2.4mm Cruciform	2.7mm	3.5mm	4.5mm
Thread Diameter	2.4mm	2.4mm	2.7mm	3.5mm	4.5mm
Thread Pitch (A)	1.0mm	1.0mm	1.0mm	1.25mm	1.75mm
Head Diameter (B)	1.5mm Hex		2.5mm Hex	2.5mm Hex	3.5mm Hex
Head Diameter (C)	4.0mm	4.0mm	5.0mm	6.0mm	8.0mm
Drill Bit for threaded hole	1.8mm	1.8mm	2.0mm	2.5mm	3.2mm
Drill bit for gliding hole	2.4mm	2.4mm	2.7mm	3.5mm	4.5mm
Core Diameter	1.6mm	1.6mm	1.9mm	2.4mm	3.0mm

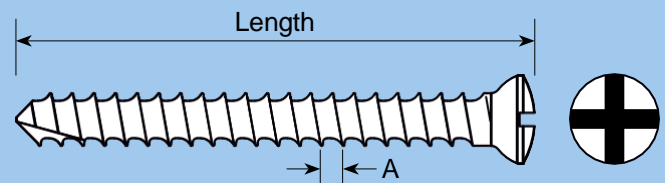
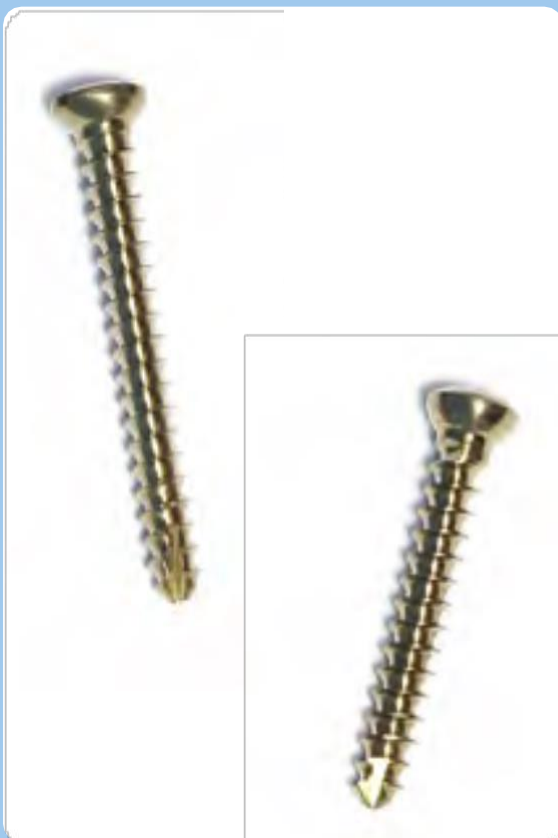

Tip Configuration

Self tapping, two flute quadrant style

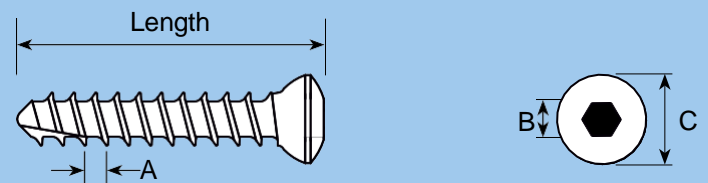
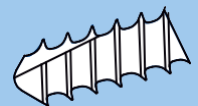



Titanium Cortical Screws

Length	Diameter 2.4mm 2.5 Hex 1.8 Pilot Drill			Diameter 2.7mm 2.5 Hex 2.0 Pilot Drill		Diameter 3.5mm 2.5 Hex 2.5 Pilot Drill		Diameter 4.5mm 3.5 Hex 3.2 Pilot Drill	
	Code	Code	RRP	Code	RRP	Code	RRP	Code	RRP
6	THS-2406	THS-2706	£7.30	-	-	-	-	-	-
8	THS-2408	THS-2708	£7.30	-	-	-	-	-	-
10	THS-2410	THS-2710	£7.30	THS-3510	£7.90	-	-	-	-
12	THS-2412	THS-2712	£7.30	THS-3512	£7.90	-	-	-	-
14	THS-2414	THS-2714	£7.30	THS-3514	£7.90	-	-	-	-
16	THS-2416	THS-2716	£7.30	THS-3516	£7.90	-	-	-	-
18	THS-2418	THS-2718	£7.30	THS-3518	£7.90	-	-	-	-
20	THS-2420	THS-2720	£7.30	THS-3520	£7.90	THS-4520	£11.00	THS-4520	£11.00
22	THS-2422	THS-2722	£7.30	THS-3522	£7.90	THS-4522	£11.00	THS-4522	£11.00
24	THS-2424	THS-2724	£7.30	THS-3524	£7.90	THS-4524	£11.00	THS-4524	£11.00
26	THS-2426	THS-2726	£7.30	THS-3526	£7.90	THS-4526	£11.00	THS-4526	£11.00
28	THS-2428	THS-2728	£7.30	THS-3528	£7.90	THS-4528	£11.00	THS-4528	£11.00
30	THS-2430	THS-2730	£7.30	THS-3530	£7.90	THS-4530	£11.00	THS-4530	£11.00
32	-	-	-	THS-3532	£7.90	THS-4532	£11.00	THS-4532	£11.00
34	-	-	-	THS-3534	£7.90	THS-4534	£11.00	THS-4534	£11.00
35	-	-	-	-	-	THS-4535	£11.00	THS-4535	£11.00
36	-	-	-	THS-3536	£7.90	THS-4536	£11.00	THS-4536	£11.00
38	-	-	-	THS-3538	£7.90	THS-4538	£11.00	THS-4538	£11.00
40	-	-	-	THS-3540	£7.90	THS-4540	£11.00	THS-4540	£11.00
42	-	-	-	-	-	THS-4542	£11.00	THS-4542	£11.00
44	-	-	-	-	-	THS-4544	£11.00	THS-4544	£11.00
45	-	-	-	-	-	THS-4545	£11.00	THS-4545	£11.00
46	-	-	-	-	-	THS-4546	£11.00	THS-4546	£11.00
48	-	-	-	-	-	THS-4548	£11.00	THS-4548	£11.00
50	-	-	-	-	-	THS-4550	£11.00	THS-4550	£11.00

TTA Screws (Cruciform Drive) Low profile

Length	Cruciform Diameter 2.4mm 1.8 Pilot Drill	
	Code	RRP
8	TCS-2408	£7.20
10	TCS-2410	£7.20
12	TCS-2412	£7.20
14	TCS-2414	£7.20
16	TCS-2416	£7.20
18	TCS-2418	£7.20
20	TCS-2420	£7.20
22	TCS-2422	£7.70
24	TCS-2424	£7.70
26	TCS-2426	£7.70
28	TCS-2428	£7.70
30	TCS-2430	£7.70
32	TCS-2432	£7.90
34	TCS-2434	£8.10
36	TCS-2436	£8.30
38	TCS-2438	£8.50
40	TCS-2440	£8.80



Hex Head

Cruciform Head

For TTA Implants please see page 168



IOHC Screws (Incomplete ossification of the humeral condyle)

This specialist screw was developed over two years to address the sometimes awkward procedure of Incomplete Ossification of the Humeral Condyle. Made from Extra Hard Implant Material (Commonly used for Arthrodesis Wires +40% than standard Shaft Bone Screws). Retains shape and wear resistant. Dual Hex Drive. Main Drive is 2.5mm Hex with an emergency 1.5mm Hex Drive for recovery on opposite end. Offering compression with cutting action flutes. The thread form is a modified HC (Locking Screw) from human ankle surgery. This screw greatly reduces previous complications of micro fractures, screw fatigue failure and reliability.

A surgeon has written a procedure for how they use these screws which may be of interest

- *Pre-op planning- Humeral trans condylar / transcortical distance - this is can be taken from a CT or a well centered and positioned CrCa or CaCr radiograph of the elbow. If using a radiograph, be sure to place a calibration marker level with and adjacent to your area of anatomical interest. It can also be very helpful to study your radiographs alongside an anatomical model to help 'visualize' these landmarks when you later palpate them though soft tissue.
- *Surgery- Once the appropriate lateral and medial landmarks are determined and soft tissue gently retracted and protected, drill a 1.1mm tunnel across the humeral condyle. The use of a universal drill aiming guide can be helpful. A scrubbed assistant will help maintain the position of the guide, as will drilling a 1.5mm diameter hole at the ideal trans cortex exit point, to anchor the drill aiming guide.
- *Remove the aiming guide, (if used). Slide a cannulated 3.2 mm drill bit over the K-wire, protect the soft tissue at the cis-cortex and steadily over drill the 1.1mm K-wire in situ. Lavage and patience are crucial- Cannulated drill bits are not as efficient and can generate considerable heat. You may have to exit one or two times to lavage debris around the K-wire via a 21G needle on a 20ml syringe, from the hole. (Exercise caution when pulling the drill bit out- placing wire forceps on the trans cortex end of the K-wire can help prevent inadvertent pull out of the K-wire)
- *Use a counter sink or 2mm curette to widen the caudal aspect of the entrance hole on the lateral condyle to help facilitate the seating of the threaded-head portion of the screw. Judicious slow speed use of a 4.5 mm drill bit and drill stop may also help widen the first 3-4mm of the hole at the cis-cortex.
- *Measure the length of the appropriate screw with a depth gauge. As a final check, review the length of the chosen screw against the exposed length of your depth gauge. Be sure to check that the trans cortex threaded portion of your chosen screw is less than half of your depth gauge distance to ensure a lagged compression.
- *Steadily insert the screw by hand in a traditional tapping motion- half to 3/4 turn clockwise, quarter turn back, to facilitate the passage of the screw in the bone stock that is often sclerotic.
- *Finally- palpate your transcortical landmarks- you should JUST be able to feel the screw tip almost level with your lateral/ medial humeral epicondyle depending on your preferred screw placement direction.
- *Consider carrying a spare screw of each length in case of accidental droppage.

IOHC

(Incomplete ossification of the humeral condyle)

Length	Code	Length	Diameter	RRP
24	IOHC-45-24	IOHC L24mm	4.5	£33.00
26	IOHC-45-26	IOHC L26mm	4.5	£33.00
28	IOHC-45-28	IOHC L28mm	4.5	£33.00
30	IOHC-45-30	IOHC L30mm	4.5	£33.00
32	IOHC-45-32	IOHC L32mm	4.5	£33.00
34	IOHC-45-34	IOHC L34mm	4.5	£33.00
36	IOHC-45-36	IOHC L36mm	4.5	£33.00
38	IOHC-45-38	IOHC L38mm	4.5	£33.00
40	IOHC-45-40	IOHC L40mm	4.5	£33.00

Thread Diameter (Main)	4.5mm
Thread Pitch	1.25mm
Drill Bit	3.2
Core Diameter	3.2mm
Hexagonal Slot	2.5mm
Retrieval Hex	1.5mm

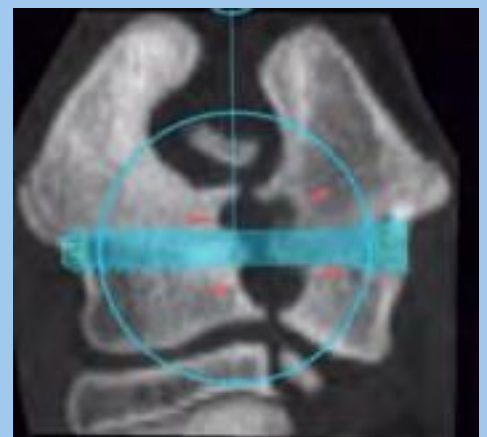
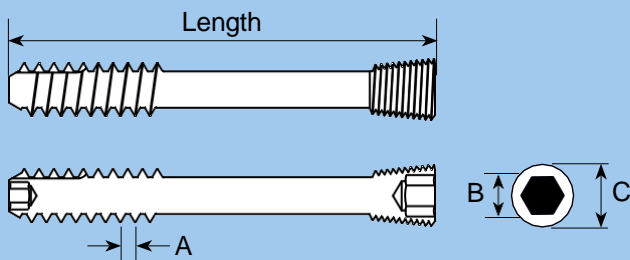

Images courtesy of
Rory Paton BVSc Cert AVP MRCVS



Headless Lag Screws

Self-Drilling and Self-Tapping Screws for small bones/ fractures where plate placement is not possible. The head is designed to screw in flush in the bone creating a lag effect and minimising tissue irritation. Requires 1.0mm screwdriver for the 1.5mm screws and 1.5mm screwdriver for the 2.0 and 2.7mm ranges

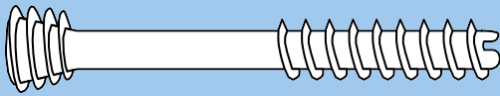

Length	Code	Description	Pilot	RRP
20	HCL-15-L	1.5mm Headless Compression Lag Screw - Large	1.1	£14.00
15	HCL-15-M	1.5mm Headless Compression Lag Screw - Medium	1.1	£14.00
10	HCL-15-S	1.5mm Headless Compression Lag Screw - Small	1.1	£14.00
25	HCL-20-L	2.0mm Headless Compression Lag Screw - Large	1.5	£16.00
20	HCL-20-M	2.0mm Headless Compression Lag Screw - Medium	1.5	£16.00
15	HCL-20-S	2.0mm Headless Compression Lag Screw - Small	1.5	£16.00
36	HCL-27-L	2.7mm Headless Compression Lag Screw - Large	2.0	£18.00
20	HCL-27-M	2.7mm Headless Compression Lag Screw - Medium	2.0	£18.00
15	HCL-27-S	2.7mm Headless Compression Lag Screw - Small	2.0	£18.00



Drills and Taps

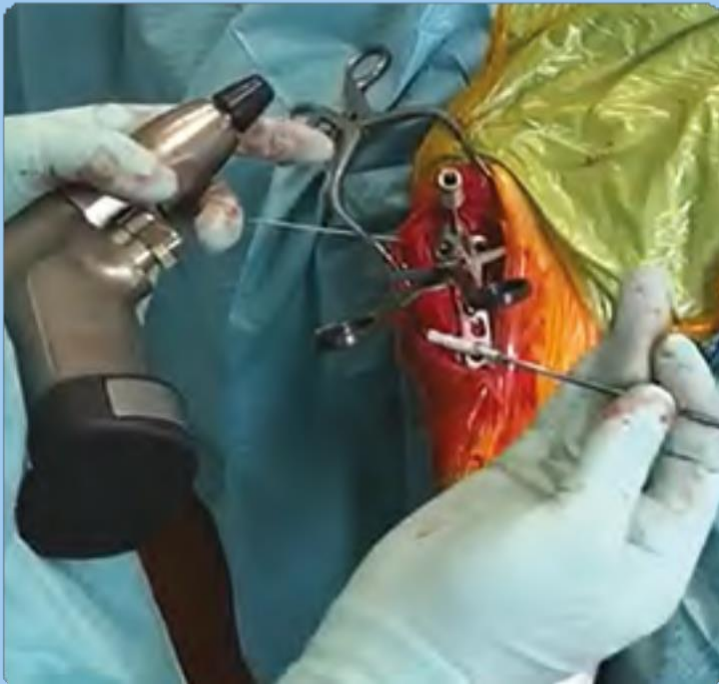

EVODURANCE® Drill Bits

Next Generation

Most Orthopaedic operations involve drilling before the insertion of screws/pins/accessories into bone. The challenge was to create a superior drill than what is currently available. The current drills have been around for decades and uses old technology without taking advantage of modern CNC grinders to create complex geometry and angled cutting flutes. Investment in medical technology has always been in the human market, leaving the Veterinary market requirements far down the list of priorities.

It is known that a rise in temperature above 43°C around a drill hole will cause Thermal Bone Necrosis, with irreversible changes in the structure and physical properties of bone. The immediate effect on the physical structure and the later effect on the cellular components both prejudice the hold of the screw as necrotic bone is reabsorbed, reducing the stability and strength of the fixation. Also the presence of necrotic tissue may delay healing and be predisposed to infection.

Causes and solutions

1. Blunt drill bits will generate higher temperatures and the increased force required for penetration causes poor control of the drill, and uncontrolled bursting through the far cortex.

Solution: Evodurance® Drill Bits (EDB) complex cutting Geometry ensures concentricity, speed and accuracy. It is highly recommended to use a drill stop until you are confident in the increased performance.

2. Blocked Flutes: The physical characteristics of bone vary considerably with its state. When drilled dry, it produces debris in small particles that are easily cleared by a drill bit and the optimal helix angle for the flute is a slow helix (less turns per revolution) which most standard Orthopaedic drill bits have. However, at the site of operation, the debris is wet and mixed with medullary fat and bio-fluids. In this state, bone debris is no longer in the form of small particles and the flutes of a slow helix drill will clog easily and generate excessive heat.

Solution: Evodurance® Drill Bits (EDB) have a quick helix in the form of a parabolic flute.

3. Increased force and wear. Standard drill points require more force to penetrate the bone because the contact surface area is larger, generating more friction, and the cutting edge does not run across the central section. If the angles are too sharp, they can cause soft tissue trauma when bursting through the far cortex. Also a more pointed tip will blunt more quickly.

Solution: Evodurance® Drill Bits (EDB) have a 100° point angle and our PVD coating with biocompatible TiCN resulting in further reduced friction generated heat.

At N2 UK Ltd we believe we are the first veterinary manufacturer to invest resources in the improvement of bone drills. Our drills will be more efficient, generate minimal friction and reduce the production of thermal energy. We are pleased to say that this style of drill is now available from our Evodurance® Drill Bit range.

References

Andrienne Y, Wagenknecht M, Donkerwolcke M, Zurbuchen C, Burny F. External fixation pin: an in vitro general investigation. *Orthopedics* 1987;10:1507-16. **Ardan NL, James JM, Herrick JF.** Ultrasonic energy and surgically produced defects in bone. *J Bone Joint Surg [Am]* 1957;39-A:394-402. **Bonfield W, Li CH.** The temperature dependence of the deformation of bone. *J Biomechanics* 1968;1:323-9. **Fuchsberger A.** Optimization of the spiral drill for use in medicine. *Z Orthop* 1987;125:290-7. **Matthews LS, Green CA, Goldstein SA.** The thermal effects of skeletal fixation-pin insertion in bone. *J Bone Joint Surg [Am]* 1984;66-A: 1077-83. **Matthews LS, Hirsch C.** Temperatures measured in human cortical bone when drilling. *J Bone Joint Surg [Am]* 1972;54-A:297-308. **Saha S, Pal S, Albright JA.** Surgical drilling: design and performance of an improved drill. *J Biomech Eng* 1982;104:245-52. **Sidak Z.** Rectangular confidence regions for the means of multivariate normal distributions. *J Am Stat Assoc* 1967;62:626-33.

Evodurance® Drill Bits

Our popular Evodurance® range has been improved, they still cut quickly and precisely as before but they have been strengthened to ensure even the most heavy-handed surgeon can use them.

Drills are coated in TiN (Titanium Nitride) to help resist wear.

Order Code	Description	RRP
EDB-QR-15-080	1.5mm Evodurance® Drill Bit AO Quick Release. Working Length 80mm	£30.00
EDB-QR-18-080	1.8mm Evodurance® Drill Bit AO Quick Release. Working Length 80mm	£30.00
EDB-QR-20-110	2.0mm Evodurance® Drill Bit AO Quick Release. Working Length 110mm	£30.00
EDB-QR-25-150	2.5mm Evodurance® Drill Bit AO Quick Release. Working Length 150mm	£30.00
EDB-QR-27-150	2.7mm Evodurance® Drill Bit AO Quick Release. Working Length 150mm	£30.00
EDB-QR-28-150	2.8mm Evodurance® Drill Bit AO Quick Release. Working Length 150mm	£30.00



These sizes are also available in plain shank contact us for further information.

We recommend the use of drill stops with these drills due to fast cutting action.

Drill Stop Set

Comprises four stoppers in an autoclaveable case simply choose the nearest stopper to your drill bit and lock it off at the required drill depth.

Order Code	Description	RRP
DR-ST-SET	Drill Stop Set in stainless steel case, for drill sizes 2.0,2.5,2.7,3.2,3.5,4.5	£88.00

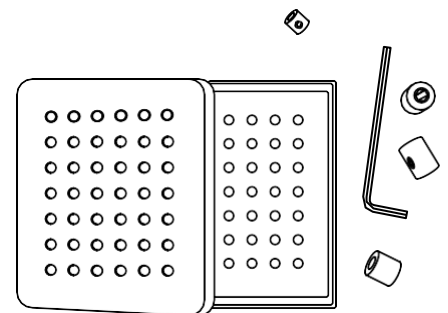



Drill Bit - Anti Skid

Standard tipped drills can slip or skid when making the initial entry into the bone especially when the angle differs from 90 degrees. Anti skid drills have a very sharp point on the end which bites into the bone and holds the drill in place, ensuring the hole is exactly where you need it.

Order Code	Diameter	Total Length	RRP
DRL-AS-15-R	1.5	60	£25.00
DRL-AS-18-R	1.8	80	£25.00
DRL-AS-20-R	2.0	100	£25.00
DRL-AS-24-R	2.4	115	£25.00
DRL-AS-25-R	2.5	130	£25.00
DRL-AS-27-R	2.7	130	£27.00
DRL-AS-32-R	3.2	130	£27.00
DRL-AS-35-R	3.5	130	£28.00

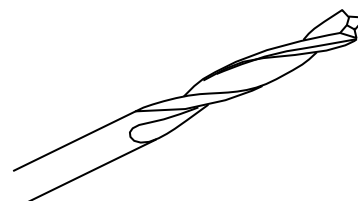

Drill Bit - Cannulated

For drilling over A-wires when drill hole angle and site are critical.

Order Code	Description	RRP
DRL-CAN-25-130	Drill Bit 2.5mm with 1.1mm Cannulation 130mm Long	£64.00
DRL-CAN-32-130	Drill Bit 3.2mm with 1.1mm Cannulation 130mm Long	£64.00
DRL-CAN-35-130	Drill Bit 3.5mm with 1.1mm Cannulation 130mm Long	£64.00

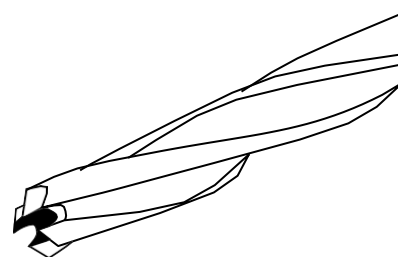

Drill Stop Set

Comprises four stoppers in an autoclaveable case simply choose the nearest stopper to your drill bit and lock it off at the required drill depth.

Order Code	Description	RRP
DR-ST-SET	Drill Stop Set in stainless steel case, for drill sizes 2.0,2.5,2.7,3.2,3.5,4.5	£88.00

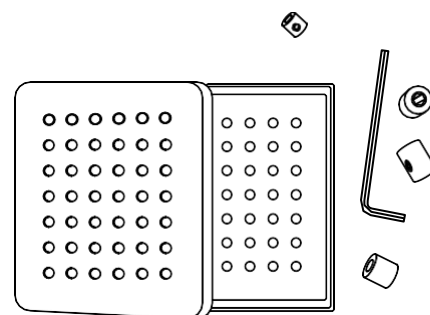

Standard Drill Bits

We have added the most common sizes and lengths to our standard drill range and offer a set price for all sizes. These drills offer excellent value.

Order Code	Diameter	Total Length	Flute Length	RRP
DRL-11-060	1.1	60	25	£14.00
DRL-11-080	1.1	80	25	£14.00
DRL-15-060	1.5	60	30	£14.00
DRL-15-080	1.5	80	30	£14.00
DRL-18-080	1.8	80	30	£14.00
DRL-18-110	1.8	110	30	£14.00
DRL-20-080	2.0	80	40	£14.00
DRL-20-110	2.0	110	40	£14.00
DRL-25-100	2.5	100	50	£14.00
DRL-25-150	2.5	150	50	£14.00
DRL-27-100	2.7	100	50	£14.00
DRL-27-150	2.7	150	50	£14.00
DRL-32-170	3.2	170	60	£14.00
DRL-35-170	3.5	170	60	£14.00
DRL-40-170	4.0	170	60	£14.00
DRL-45-170	4.5	170	60	£14.00





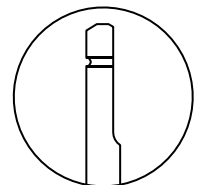

Order Code	Diameter	Total Length	Flute Length	RRP
DRL-QR-11-060	1.1	85	25	£19.00
DRL-QR-11-080	1.1	105	25	£19.00
DRL-QR-15-060	1.5	85	25	£19.00
DRL-QR-15-080	1.5	105	30	£19.00
DRL-QR-18-080	1.8	105	40	£19.00
DRL-QR-18-110	1.8	135	40	£19.00
DRL-QR-20-080	2.0	105	40	£19.00
DRL-QR-20-115	2.0	130	40	£19.00
DRL-QR-24-100	2.4	125	50	£19.00
DRL-QR-25-100	2.5	125	40	£19.00
DRL-QR-25-150	2.5	175	40	£19.00
DRL-QR-27-100	2.7	125	40	£19.00
DRL-QR-27-150	2.7	125	40	£19.00
DRL-QR-27-170	2.7	170	60	£19.00
DRL-QR-28-150	2.8	175	40	£19.00
DRL-QR-32-170	3.2	195	60	£19.00
DRL-QR-35-170	3.5	195	60	£19.00
DRL-QR-40-170	4.0	195	60	£19.00
DRL-QR-45-170	4.5	195	60	£19.00





Hex Head Screwdrivers

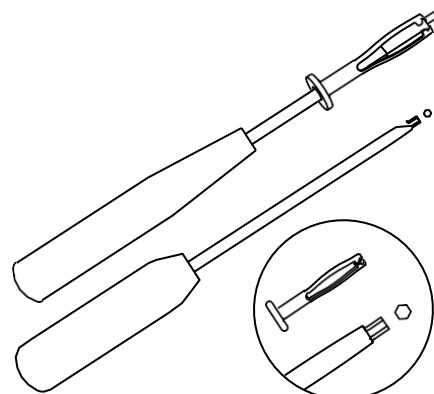

Standard Screwdrivers for Hex Head Screws.

Order Code	Description	RRP
SD-H15	 Screwdriver for 1.5mm, 2.0mm and 2.4mm Hex Screws with Sleeve	£36.00
SD-H20	 Screwdriver for 2.4mm screws with 2.0mm Hex Screws with Sleeve	£36.00
SD-H25	 Screwdriver for 2.7mm, 3.5mm and 4.0mm Hex Screws with Sleeve	£36.00
SD-H35	 Screwdriver for 4.5mm, 5.5mm and 6.5mm Hex Screws with Sleeve	£36.00



Torx/Star Head Screwdrivers



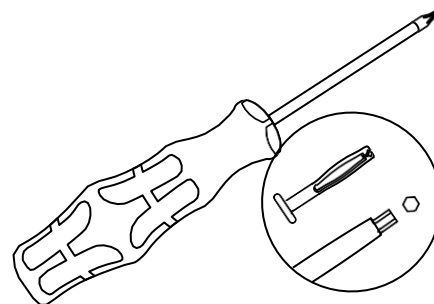

Hardened Tipped Screwdrivers for Torx Screws.

Order Code	Description	RRP
SD-TD-T6	 Screwdriver for 2.0mm Star Torx Drive Locking Screws	£47.00
SD-TD-T8	 Screwdriver for 2.4mm/2.7mm Star Torx Drive Locking Screws	£47.00
SD-TD-T15	 Screwdriver for 3.5mm Star Torx Drive Locking Screws	£47.00



Quick release Screwdriver Tips

Superior quality Hardened Screwdriver Tips.

Order Code	Fits Screw sizes	RRP
SDT-QR-H15	 Hex Screwdriver Tip for 1.5,2.0,2.4mm Screws	£33.00
SDT-QR-H20	 Hex Screwdriver Tip for 2.4mm Cortical Screws with 2.0mm hex	£33.00
SDT-QR-H25	 Hex Screwdriver Tip for 2.7,3.5,4.0mm Screws	£33.00
SDT-QR-H35	 Hex Screwdriver Tip for 4.5,6.5mm Screws	£33.00
SDT-QR-C24	 2.4mm with Cruciform Drive	£33.00

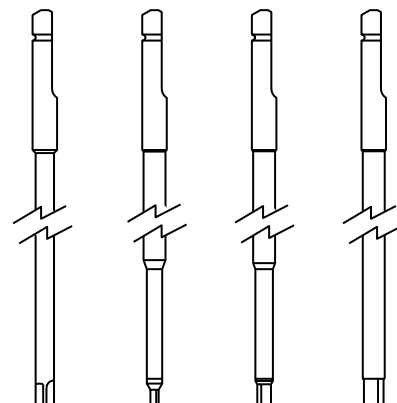

Premium Screwdrivers Tips

Superior quality Hardened Screwdriver Tips for Star Torx Head Screws.

Order Code	Description	RRP
SDT-QR-T6	T6 Premium Screwdriver Tip for 2.0mm Torx Head Screws	£110.00
SDT-QR-T8	T8 Premium Screwdriver Tip for 2.4/2.7mm Torx Head Screws	£110.00
SDT-QR-T15	T15 Premium Screwdriver Tip for 3.5mm Torx Head Screws	£110.00



Screw Holding Sleeves

Order Code	Description	RRP
SD-SLEEVE-152024	Spare Screw Holding Sleeve for 1.5mm Hex Screwdriver (SD-H15)	£18.00
SD-SLEEVE-273540	Spare Screw Holding Sleeve for 2.5mm Hex Screwdriver (SD-H25)	£18.00
SD-SLEEVE-4565	Spare Screw Holding Sleeve for 3.5mm Hex Screwdriver (SD-H35)	£18.00
SHS-T6	Screw Holding Sleeve for T6 Screwdriver and Premium tips	£18.00
SHS-T8	Screw Holding Sleeve for T8 Screwdriver and Premium tips	£18.00
SHS-T15	Screw Holding Sleeve for T15 Screwdriver and Premium tips	£18.00

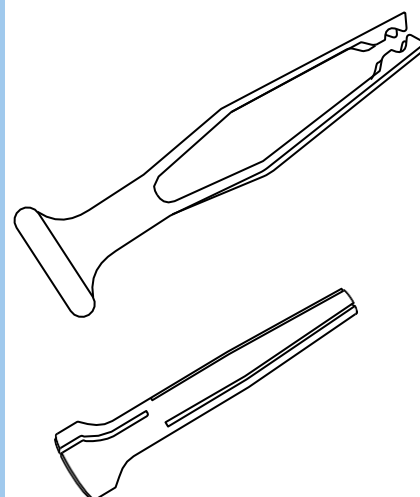

Screwdriver to fit all Suture Head Screws, for kit see page 105 of our Instrument Catalogue.

Order Code	Description	RRP
SA-INSERT	Universal Suture Screw Insertion Driver	£65.00

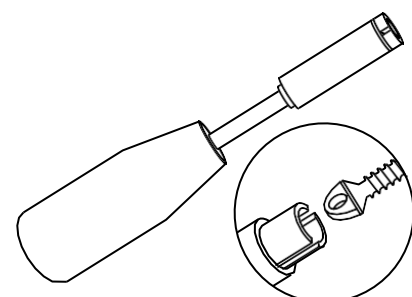



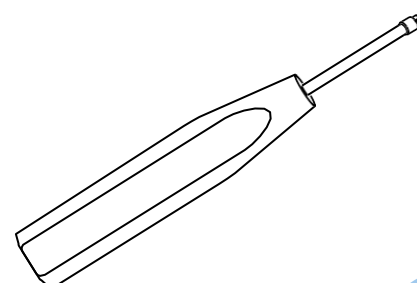

2.4mm Cross Head Screwdriver for TCS-24 Screws.

Order Code	Description	RRP
SD-C24	 Screwdriver 2.4mm Cross-Head (2.4mm Titanium Screws)	£41.00





Sherman Screwdrivers

Order Code	Description	RRP
SD-F20-L17	 Screwdriver Flat Head 2.0mm Length 175mm	£20.00
SD-F27-L17	 Screwdriver Flat Head 2.7mm Length 175mm	£20.00
SD-F35-L17	 Screwdriver Flat Head 3.5mm Length 175mm	£20.00
SD-C35-L25	 Screwdriver Cross Head 3.5mm Length 250mm	£20.00

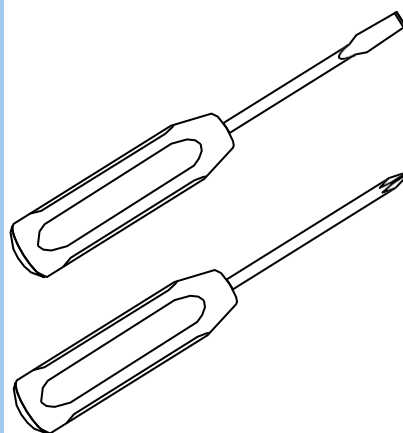

Screw Driver Handles - Premium AO & Dental Fit Quick Release

A range of premium screwdrivers with a silicone handle, available in standard quick fit, T-bar and dental fit. The silicone handle greatly improves the anti-slip surface in a gloved hand, whilst also being easier to clean.

Order Code	Description	RRP
SGH-DF	Premium Quality Comfort Silicone Handle - Dental Fit	£140.00
SGH-QF	Premium Quality Comfort Silicone Handle - AO Quick Release	£140.00
STH-QF	Premium Quality Comfort Silicone Handle - T-Bar AO Quick Release	£140.00



Colour may vary

There is also a standard version with Teflon handle.

Order Code	Description	RRP
SD-TFN-QR	Standard Teflon Quick Release Screwdriver Handle	£60.00

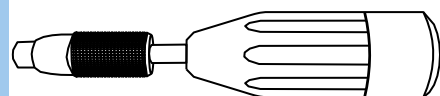

Drill Storage Box

Marked to hold the following drill bits.

1.1, 1.5, 1.8, 2.0, 2.4, 2.5, 2.7, 3.2, 3.5, 4, 4.5

Order Code	Description	RRP
DR-BOX	Drill Box Empty	£95.00
DR-BOX-FULL	Drill Box Complete with 1.1, 1.5, 1.8, 2.0, 2.4, 2.5, 2.7, 3.2, 3.5, 4, 4.5mm drills	£180.00



Taps Quick Release AO / Dental Fit

Taps are designed to cut a thread prior to screw placement. Removal of the material allows the screws to be placed in the bone much easier and reduces risk of stripping.

N2 taps are hardened to last longer and the threads are cut with a sharp edge to aid the pre tapping process.

Order Code	Description	RRP
Cortical Taps		
TAP-QRD-15	1.5mm Cortical Tap with Dental quick fit	£51.00
TAP-QRD-20	2.0mm Cortical Tap with Dental quick fit	£51.00
TAP-QR-24	2.4mm Cortical tap with AO quick fit	£51.00
TAP-QR-27	2.7mm Cortical tap with AO quick fit	£51.00
TAP-QR-35	3.5mm Cortical tap with AO quick fit	£51.00
TAP-QR-45	4.5mm Cortical tap with AO quick fit	£51.00
TAP-QR-45L	4.5mm Cortical tap extra long with AO quick fit	£51.00
TAP-QR-55	5.5mm Cortical tap with AO quick fit	£51.00
Locking Taps		
TAP-QR-LOC-24	2.4mm Locking screw tap with AO quick fit	£62.00
TAP-QR-LOC-27	2.7mm Locking screw tap with AO quick fit	£62.00
TAP-QR-LOC-35	3.5mm Locking screw tap with AO quick fit	£62.00

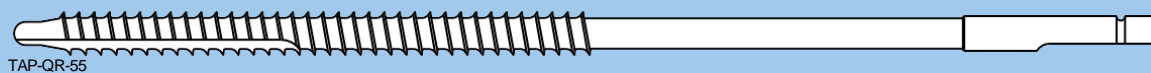

For full terms and conditions please visit our website.

Wires and Pins



















	Page
Kirschner Wires (K-wires), Steinmann Pins, Denham pins and guide wires	45
Steinman Intra-Medullary Pin Trocar Tips	46
Steinman Intra-Medullary Pin Threaded Trocar / Plain Trocar Tips	46
Kirschner Wire (Trocar both ends)	47
Extra Long Kirschner Wires	47
Kirschner Wire (Bayonet / Round)	47
Fully Threaded Kirschner Wires Trocar / Trocar	48
2.0mm Fine Threaded Fragment Pins	48
Negative Threaded Pins Cortical End Thread	48
Negative Threaded Ellis Pins Short Fine End Thread	49
Positive Threaded Pins Cortical End Thread	49
TPLO Jig Guide Pin	49
Stabilising pin with olive	49
Positive Threaded Pins Cortical Mid Thread	50
Positive Threaded Pins Cancellous End Thread	50
Positive Threaded Pins Cancellous Mid Thread	50

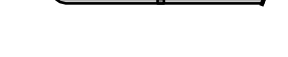

Kirschner Wires (K-wires), Steinmann Pins, Denham pins and guide wires

Wire Diameters Ø Available
0.80mm
0.90mm
1.00mm
1.10mm
1.20mm
1.25mm
1.40mm
1.50mm
1.60mm
1.80mm
2.00mm
2.20mm
2.40mm
2.50mm
2.80mm
3.00mm
3.18mm
3.50mm
4.00mm
4.50mm
5.00mm
6.00mm
6.35mm
8.00mm

Variables on end type	Code	Comments	
	Trocar (Trochar)	T	3 Faceted triangular point
	Bayonet	B	Spade drill style point
	Round	R	Blunt round end
	Dome	D	Blunt domed end
	Triangle	A	3 Faced tri-drive
	Square	Q	4 Faced square-drive
	Drill Point	P	Short 4 facet drill point
	Eyelet	E	Eyelet (suture loop)

Variables on end type	Code	Comments	
	Fully Threaded	PFT	Thread runs full length of wire
	Front End Threaded Short	PST	5-10mm of front end thread
	Front End Threaded Long	PLT	15-30mm of front end thread
	No Thread	PIN	Parallel shaft with no thread
	Positive Mid Thread (Denham Pin)	PMT	Threaded mid section diameter larger than pin shaft
	Positive End Thread	PET	Threaded end section diameter larger than pin shaft

Kirschner Wires

Unthreaded Kirschner Wires are supplied in several formats, Trocar point in which the tip is sharpened to a 3 facet point, Bayonet point which provides a spade drill for improved cutting, Triangular end to allow greater grip in the jaws of the drill, and Round end, plain finished with domed tip. Threaded, trocar pointed wires are also available for use as guide wires.

Steinmann Pins

Used in skeletal traction for alignment and reduction of fractures and with certain external fixation systems. Steinmann Pins are supplied either with a three facet trocar point or 'spade drill type' bayonet point. The ends

of the pins are available either triangular or round.

Material

Material for sizes up to Ø5.00mm = Stainless Steel ISO5832-1 XH (extra high) = 1400 N/mm²

Material for sizes over Ø5.00mm = Stainless Steel ISO5832-1 HI (high) = 1100 N/mm²

Order Code explained

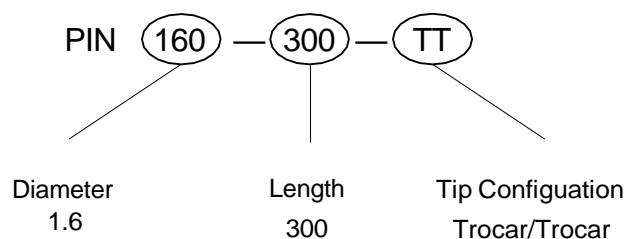

Steinman Intra-Medullary Pin Trocar Tips

Order Code	Pin Diameter	Length	RRP
PIN-100-300-TT	1.00	300	£4.50
PIN-150-300-TT	3.00	300	£4.50
PIN-160-300-TT	1.60	300	£3.50
PIN-200-300-TT	2.00	300	£3.70
PIN-240-300-TT	2.40	300	£3.90
PIN-250-300-TT	2.50	300	£4.50
PIN-280-300-TT	2.80	300	£4.00
PIN-320-300-TT	3.20	300	£4.20
PIN-360-300-TT	3.60	300	£4.70
PIN-400-300-TT	4.00	300	£5.60
PIN-480-300-TT	4.80	300	£7.30
PIN-560-300-TT	5.60	300	£10.50
PIN-635-300-TT	6.35	300	£9.00
PIN-800-300-TT	8.00	300	£10.50

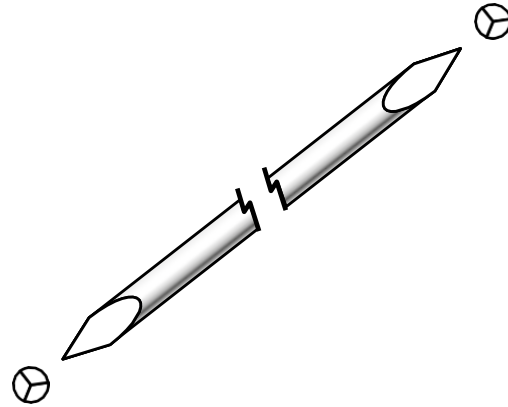

Steinman Intra-Medullary Pin Threaded Trocar / Plain Trocar Tips

Order Code	Pin Diameter	Length/ Thread	RRP
PLT-160-300-TT	1.60	300 / 30	£5.00
PLT-200-300-TT	2.00	300 / 30	£5.10
PLT-240-300-TT	2.40	300 / 30	£5.30
PLT-280-300-TT	2.80	300 / 30	£5.50
PLT-320-300-TT	3.20	300 / 30	£5.60
PLT-360-300-TT	3.60	300 / 30	£6.20
PLT-400-300-TT	4.00	300 / 30	£7.00
PLT-480-300-TT	4.80	300 / 30	£8.70
PLT-635-300-TT	6.35	300 / 30	£9.60
PLT-800-300-TT	8.00	300 / 30	£10.20
PLT-560-300-TT	5.60	300 / 30	£10.20

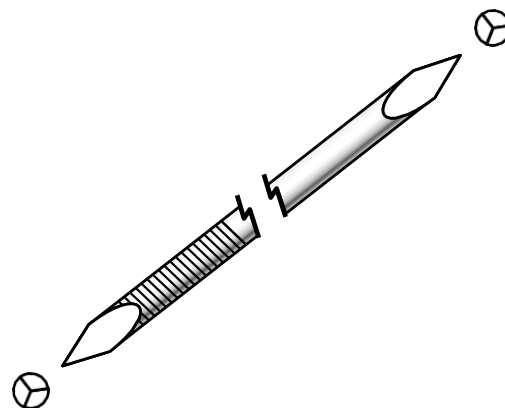

Kirschner Wire (Trocar both ends) Sold in packs of 10

Order Code	Pin Diameter	Length	RRP
PIN-080-125-TT	0.80	125	£19.60
PIN-090-125-TT	0.90	125	£19.60
PIN-100-125-TT	1.00	125	£19.60
PIN-110-125-TT	1.10	125	£19.60
PIN-125-125-TT	1.25	125	£19.60
PIN-140-125-TT	1.40	125	£19.60
PIN-150-125-TT	1.50	125	£19.60
PIN-160-125-TT	1.60	125	£19.60
PIN-180-125-TT	1.80	125	£19.60
PIN-200-125-TT	2.00	125	£19.60

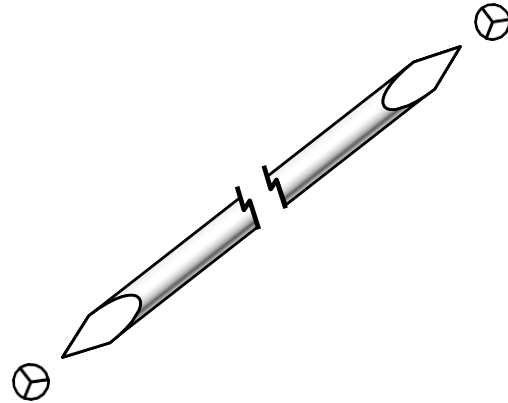

Extra Long Kirschner Wires

Order Code	Pin Diameter	Length	RRP
PIN-125-150-TT	1.25	150	£19.60
PIN-140-160-TT	1.40	160	£19.60
PIN-160-160-TT	1.60	160	£19.60

Kirschner Wire (Bayonet / Round) Sold in packs of 10

Order Code	Pin Diameter	Length	RRP
PIN-090-125-BR	0.90	125	£21.20
PIN-100-125-BR	1.00	125	£21.20
PIN-110-125-BR	1.10	125	£21.20
PIN-125-125-BR	1.25	125	£21.20
PIN-140-125-BR	1.40	125	£21.20
PIN-150-125-BR	1.50	125	£21.20
PIN-160-125-BR	1.60	125	£21.20
PIN-180-125-BR	1.80	125	£21.20
PIN-200-125-BR	2.00	125	£21.20

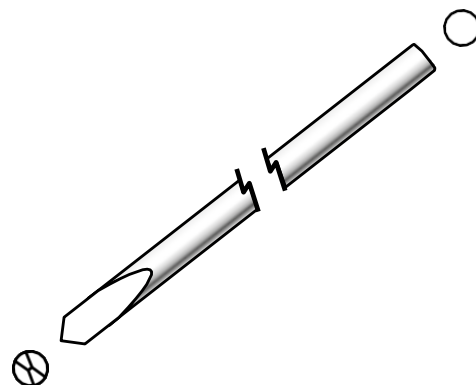



Fully Threaded Kirschner Wires Trocar / Trocar

Order Code	Pin Diameter	Length / Thread	RRP
PFT-110-150-TT	1.10	150	£7.90
PFT-150-150-TT	1.50	150	£7.90
PFT-160-150-TT	1.60	150	£7.90
PFT-200-150-TT	2.00	150	£7.90

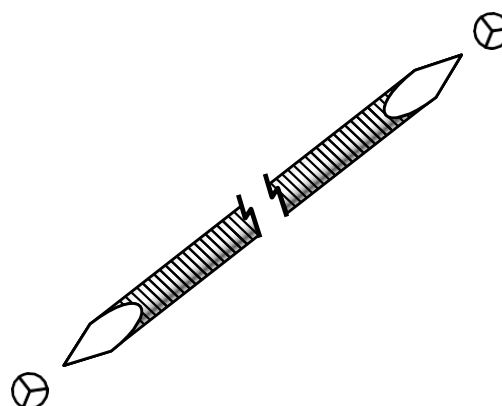

2.0mm Fine Threaded Fragment Pins

Order Code	Pin Diameter	Length / Thread	RRP
PIN-M2-05	2.0	125 / 5	£10.30
PIN-M2-10	2.0	125 / 10	£10.40
PIN-M2-15	2.0	125 / 15	£10.60
PIN-M2-20	2.0	125 / 20	£10.80
PIN-M2-25	2.0	125 / 25	£10.90
PIN-M2-30	2.0	125 / 30	£11.10
PIN-M2-40	2.0	125 / 40	£11.30
WAS-M2	Fine threaded washer 5.0 dia		£5.00

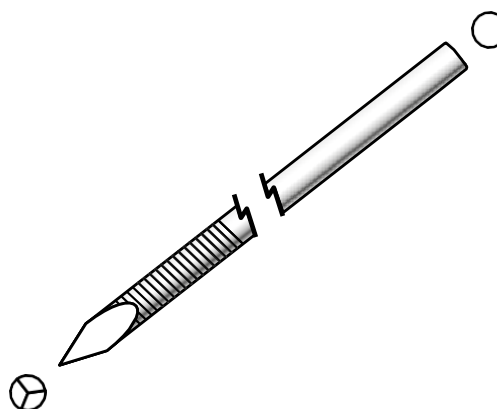

Negative Threaded Pins Cortical End Thread

Order Code	Pin Diameter	Length / Thread	RRP
PLT-110-070-TR	1.1	70 / 15	£5.30
PLT-150-070-TR	1.5	70 / 15	£5.30
PLT-160-070-TR	1.6	70 / 20	£5.30
PLT-180-085-TR	1.8	85 / 25	£5.80
PLT-200-085-TR	2.0	85 / 25	£6.20
PLT-240-100-TR	2.4	100 / 25	£6.20
PLT-300-130-TR	3.0	130 / 35	£7.00
PLT-350-130-TR	3.5	130 / 40	£7.00
PLT-400-150-TR	4.0	150 / 45	£7.70
PLT-500-150-TR	5.0	150 / 50	£9.40

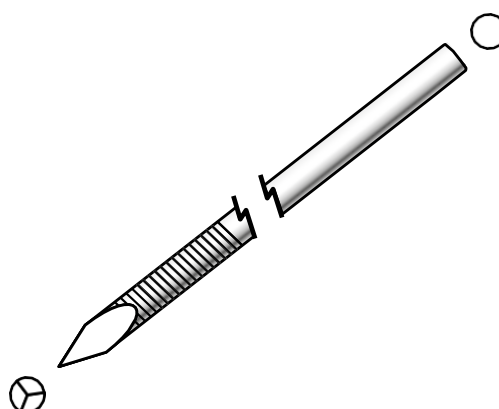

Negative Threaded Ellis Pins Short Fine End Thread

Order Code	Pin Diameter	Length / Thread	RRP
PST-110-070-TR	1.1	70 / 5	£5.30
PST-160-070-TR	1.6	70 / 5	£5.30
PST-160-085-TR	1.6	85 / 5	£5.30
PST-180-085-TR	1.8	85 / 10	£5.30
PST-200-085-TR	2.0	85 / 10	£5.30
PST-200-130-TR	2.0	130 / 10	£5.30
PST-280-115-TR	2.8	100 / 15	£5.30
PST-240-100-TR	2.4	100 / 10	£5.30
PST-240-130-TR	2.4	130 / 10	£5.30
PST-320-130-TR	3.2	130 / 15	£5.30
PST-300-130-TR	3.0	130 / 15	£5.30
PST-360-130-TR	3.6	130 / 15	£5.30
PST-400-150-TR	4.0	150 / 20	£5.30

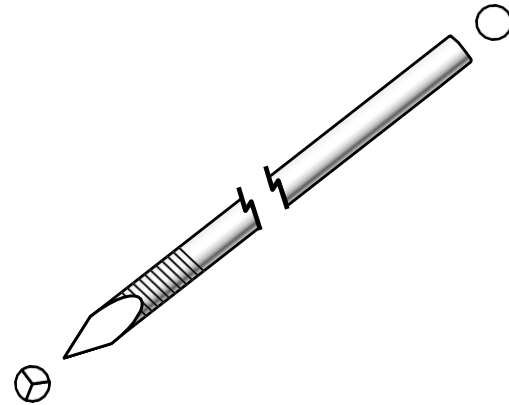

Positive Threaded Pins Cortical End Thread

Order Code	Shank / Thread	Length	RRP
PET-1620-070-TR	1.6 / 2.0	70	£7.30
PET-1822-070-TR	1.8 / 2.2	70	£7.30
PET-2024-085-TR	2.0 / 2.4	85	£7.30
PET-2432-100-TR	2.4 / 3.2	100	£7.90
PET-2735-110-TR	2.7 / 3.5	110	£7.90
PET-3036-120-TR	3.0 / 3.6	120	£8.70
PET-3240-130-TR	3.2 / 4.0	130	£8.70
PET-3543-130-TR	3.5 / 4.3	130	£10.40
PET-4048-150-TR	4.0 / 4.8	150	£10.40

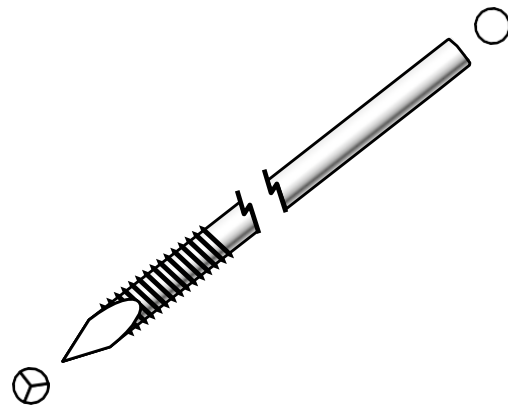

TPLO Jig Guide Pin

Order Code	Shank / Thread	Length	RRP
PIN-TPLOS-32	3.2	125	£5.20

Stabilising pin with olive

Order Code	Shank / Thread	Length	RRP
PIN-OL3-160-125-TR	1.6	125	£10.00

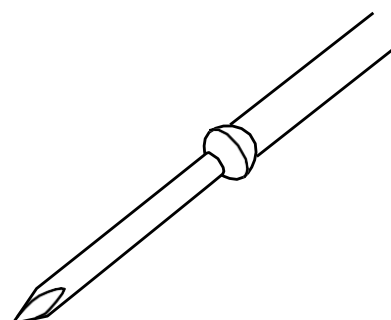



Positive Threaded Pins Cortical Mid Thread

Order Code	Shank / Thread	Length	RRP
PMT-1620-085-TR	1.6 / 2.0	85	£9.90
PMT-1822-085-TR	1.8 / 2.2	85	£9.90
PMT-2024-105-TR	2.0 / 2.4	105	£9.90
PMT-2432-105-TR	2.4 / 3.2	105	£10.40
PMT-2735-115-TR	2.7 / 3.5	115	£10.40
PMT-3036-120-TR	3.0 / 3.6	120	£11.40
PMT-3240-130-TR	3.2 / 4.0	130	£11.40
PMT-3543-140-TR	3.5 / 4.3	140	£12.40
PMT-4048-150-TR	4.0 / 4.8	150	£13.40

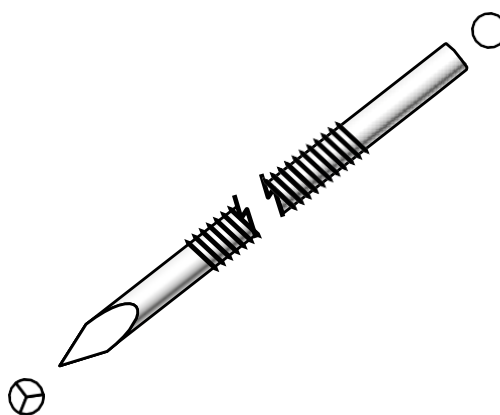

Positive Threaded Pins Cancellous End Thread

Order Code	Shank / Thread	Length	RRP
PETC-2435-115-TR	2.4 / 3.5	115	£8.90
PETC-3248-150-TR	3.2 / 4.8	150	£9.90

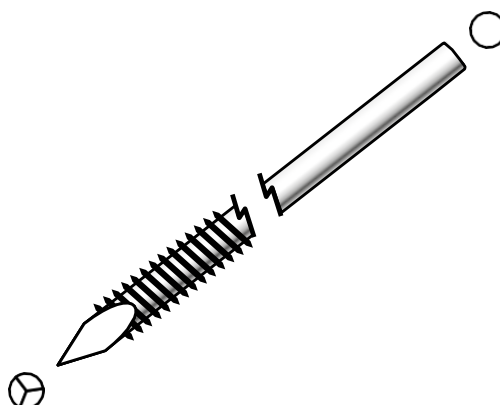

Positive Threaded Pins Cancellous Mid Thread

Order Code	Shank / Thread	Length	RRP
PMTC-2435-150-TR	2.4 / 3.5	150	£9.90
PMTC-3248-180-TR	3.2 / 4.8	180	£10.90

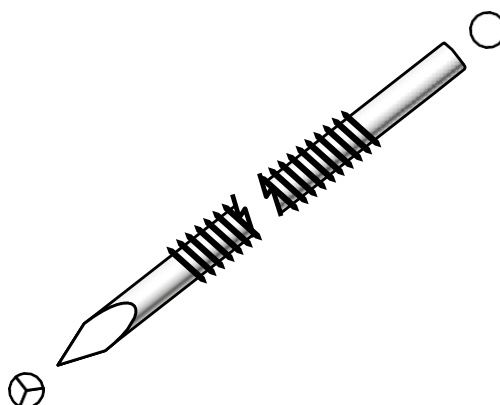

Bone Plates





Not just any Bone Plate, but an N2 Bone Plate

Let's talk Bone Plates

I would like to introduce you to how a plate is made to our standards.

Firstly, we never sub-contract, buy in and refinish/ repackage other supplier's implants.

We do not skip processes or cut corners on our processes for our Human or Veterinary Implants, and both are of equal quality.

Some IP details and manufacturing specifics are left out for obvious reasons.....

My "3.5mm Compression Plate"

1. The raw material is a pre-determined extruded profile (Shape) direct from the Steel Mill. The same profile is used in the Human Market and tested for structural tensile strength, contaminants and composition. The raw material batches are registered, inspected for imperfections and approved prior to manufacturing and must meet stringent ISO specifications.

All our Implants are made from:



Profile

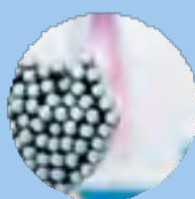

Bar

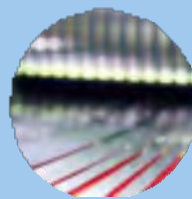

Strip



Sheets

2. The Profile is machined with compression features to size and length using specialist certified carbide tooling and degreased. It is Inspected by the operator using gauges and shadowgraph and documented. All products are made with a WIP card (work in progress) containing a technical drawing, procedures (GPN) as this tells the whole manufacturing life of the Implant for total traceability. This includes the quantity, date and signature of everybody involved in the process from beginning to end.
3. Cleaning to the next level. We have four types of cleaning in Implants manufacturing. Ultrasonic cleaners remove debris from Bone Plates which have been machined in bio de-gradeable cutting oil, degreasers clean products using neat cutting oils, blast washing removes Bead Blasting residue and Acid cleans prior to final inspection. The machines themselves have a strict cleaning regime and tested for PH Levels, bacteria and tramp oil (mixture of lubricants, coolant and metal residues).
4. The plate is then manually 'Linished'. This process can only be done by hand and removes any surface machining marks, scale and imperfections. This is a process either using a cutting impregnated belt or specialist rotating wheel.
5. **Cut Back.** The machine then spends approximately 17 hours being rumbled in a 300 Litre vibratory bowl to break down all the edges to a consistent size. The actual process is a guarded secret and 'Black Art' and took about 18 months of trials to achieve the optimal results. 'Cut Back' is when thousands of shaped pieces are rumbled and rotated with filtered water and 'X' chemical against the products to remove minor burrs and smoothing all the edges consistently. The shaped pieces, known as media, will gradually wear and need constant replacing.

6. **Vibratory Grind.** Like using grit in sandpaper the product is ground down using porceline to smooth the surface finish of the plate. The pastes start with a coarse grit and then becomes finer with time.

7. **Vibratory Polish.** This process is a gentle slow polish using ultra fine polishing pastes.

The finishing process takes place over a three day period using small porceline shapes. Unlike the 'Cut Back' process the actual media does not break down but acts as a carrier to the pastes to grind the product in every direction. A three stage process to ensure the surface is ultra smooth, no sharp edges, and free from imperfections or inclusions.



8. **Vibratory Burnish.** This will use porceline chips as a carrier to buff the surface finish of the plate. Cleaned, washed and dried.

9. **Electropolishing** removes a very minute layer of material whereas electroplating adds a layer of material. In lay mans terms Electropolishing is a mixture of two acids (green in colour) in a hot bubbly cauldron and electricity is passed through the mix to remove a layer of material. This process is a 'dark art' and requires a critical data for electricity, time and weight to calculate to achieve the required result. This process removes the microscopic peaks and valleys from the surface for an even greater polished finish.

10. **BeadBlasting.** The plate is then surface treated with ceramic bead to give a non reflective look. Cleaned and washed.

11. The plate is then treated for 20 minutes in a diluted mixture of Nitric acid to ensure any contaminates are removed from all of the manufacturing processes

The product is then washed in clean water and dried using micro fibre clothes and using protective gloves.

12. The product then undergoes final Inspection including visual and dimensional checks.

13. We then use a Windows based Laser system to mark the product or coded as per customer specification.

14. It is then registered and packaged in sealed foil pouches. The product data and full history is electronically scanned and stored on site and to the cloud for full traceability.





	Page
1.5mm Mini Self Compression Plate	56
2.0mm Mini Self Compression Plate	56
2.0mm Broad Mini Self Compression Plate	58
2.4mm Mini Self Compression Plate	58
2.7mm Mini Self Compression Plate Thin	60
2.7mm Mini Self Compression Plate Thick	60
3.5mm Self Compression Plate Straight Narrow	62
3.5mm Self Compression Plate Straight Broad	64
4.5mm Self Compression Plate Straight Narrow	66
4.5mm Self Compression Plate Straight Broad	68
2.0/2.7/3.5/4.5mm Buttress Bridge Plate (Biological Healing Plate)	70
3.5mm Broad Buttress Bridge Plate (Biological Healing Plate)	72
2.0mm Mini Plate Straight Tubular	74
2.7mm Quarter Tubular	74
3.5mm One Third Tubular	74
2.7mm Reconstruction Plates	76
3.5mm Reconstruction Plates	76
Cutable Plates	78
Cutable Malleable Plates	78
Broad Cutable Plates	78
H-Plates	80
2.0mm Distal Plates	80
2.7mm Distal Plates	80
3.5 T-Plates Round Hole	80
Acetabular Plates	80
Hybrid T-Plates	82
Pantarsal Arthrodesis Plates	84

	Page
Canine Cranial Pantarsal Arthrodesis Plate	86
Feline Pantarsal Plate Cranial Position	86
Partial Carpal Arthrodesis Plate	88
Pancarpal Arthrodesis Plates DCP Style	88
Pancarpal Arthrodesis Plates Round Holes	88
Locking Pancarpal Arthrodesis	88
2.0mm Limited Contact Plate	90
2.4mm Limited Contact Plate	90
2.7mm Limited Contact Plate	92
3.5mm Limited Contact Plate	94
3.5mm Broad Limited Contact Plate	96
Supracondylar Osteotomy (Distal Femur) Plates	98
Supracondylar Osteotomy Plates	98
Intertarsal Arthrodesis Plates	98
2.0mm Round Hole Plate	100
2.7mm Round Hole Plate	100
3.5mm Round Hole Plate	100
2.7mm Heavy Duty Round Hole Plate	102
3.5mm Heavy Duty Round Hole Plate	102
TPO EQ	104
TPLO Delta 'Style' Plates	104
TPLO (Slocum style)	106
TPLO Compression Plates	106
TPLO Pre Contoured Compression Plates	106
Titanium Plates	108
Titanium TPLO Compression Plates	108
Titanium TPLO Delta Plates	108
Titanium Pancarpal and Pantarsal	110



1.5mm Mini Compression Plate

Order Code	No. of Holes	Length mm	RRP
MCP-15-02	2	11	£23.80
MCP-15-03	3	15	£23.80
MCP-15-04	4	19	£23.80
MCP-15-05	5	23	£27.20
MCP-15-06	6	27	£30.60
MCP-15-07	7	31	£34.00
MCP-15-08	8	35	£37.40
MCP-15-09	9	39	£40.80
MCP-15-10	10	43	£44.10
MCP-15-11	11	47	£47.50
MCP-15-12	12	51	£50.90
MCP-15-13	13	55	£57.70
MCP-15-14	14	59	£64.50

1.5mm Compression Plate - Dimensions are 4mm wide, 1mm thick.









2.0mm Mini Self Compression Plate

Order Code	No. of Holes	Length mm	RRP
MCP-20-02	2	12	£17.00
MCP-20-03	3	17	£20.40
MCP-20-04	4	22	£23.80
MCP-20-05	5	27	£27.20
MCP-20-06	6	32	£30.60
MCP-20-07	7	37	£34.00
MCP-20-08	8	42	£37.40
MCP-20-09	9	47	£40.80
MCP-20-10	10	52	£44.10
MCP-20-11	11	57	£47.50
MCP-20-12	12	62	£50.90
MCP-20-13	13	67	£54.30
MCP-20-14	14	72	£57.70

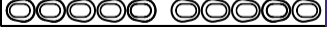
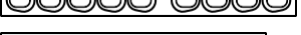

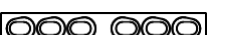







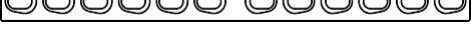

2.0mm Compression Plate - Dimensions are 5mm wide, 1mm thick up to 6 holes and 1.5mm thick upwards. Use with 2.0mm Cortical Screws.

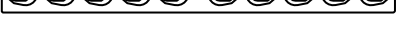
1.5mm Mini Compression Plate

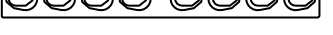
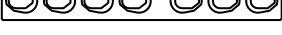
MCP-15-13	
MCP-15-12	
MCP-15-11	
MCP-15-10	
MCP-15-09	
MCP-15-08	
MCP-15-07	
MCP-15-06	
MCP-15-05	
MCP-15-04	

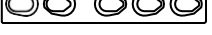
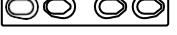
2.0mm Mini Self Compression Plate

MCP-20-14	
MCP-20-13	
MCP-20-12	
MCP-20-11	
MCP-20-10	
MCP-20-09	
MCP-20-08	
MCP-20-07	
MCP-20-06	
MCP-20-05	
MCP-20-04	
MCP-20-03	
MCP-20-02	

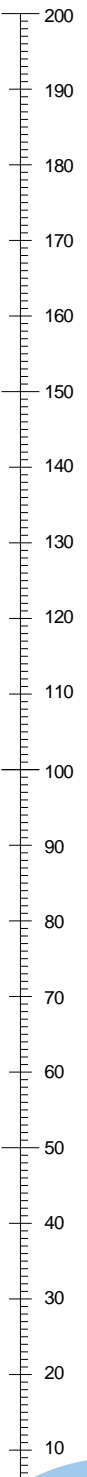



2.0mm Broad Mini Compression Plate

Order Code	No. of Holes	Length mm	RRP
MCPX-20-02	2	12	£17.00
MCPX-20-03	3	17	£20.40
MCPX-20-04	4	22	£23.80
MCPX-20-05	5	27	£27.20
MCPX-20-06	6	32	£30.60

2.0mm Compression Plate Broad - Dimensions are 5mm wide by 1.5mm thick. Use with 2.0mm Cortical Screws.



2.4mm Mini Self Compression Plate

Order Code	No. of Holes	Length mm	RRP
MCP-24-04	4	31.5	£22.10
MCP-24-05	5	38.5	£25.50
MCP-24-06	6	45.5	£28.90
MCP-24-07	7	52.5	£32.30
MCP-24-08	8	59.5	£35.70
MCP-24-09	9	66.5	£39.10
MCP-24-10	10	73.5	£42.40
MCP-24-11	11	80.5	£45.90
MCP-24-12	12	87.5	£49.20
MCP-24-13	13	94.5	£52.60
MCP-24-14	14	101.5	£56.00
MCP-24-16	16	115.5	£62.80



2.4mm Compression Plate - Dimensions are 7mm wide, 2mm thick. Use with 2.4mm Cortical Screws.

Self-compressing plates that achieve axial compression of the fracture site by combining screw hole geometry with screw insertion. Screws can be inserted off centre to the screw hole so that when tightened the head will glide alongside the hole displacing the plate in the direction of the fracture resulting in compression. They can adapt to many different internal fixation situations and function as a dynamic compression plate, a neutralization plate, or be used in bridging fashion as a lengthening plate. Use with ISO standard Cortical Bone Screws with spherical head.

All Plates are made from Stainless Steel ISO 5832-1

2.0mm Broad Mini Self Compression Plate

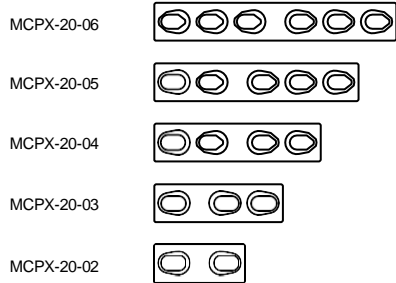

2.4mm Mini Self Compression Plate

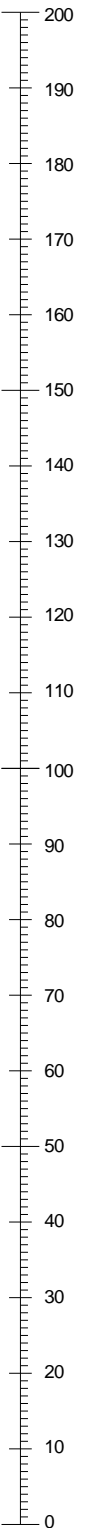
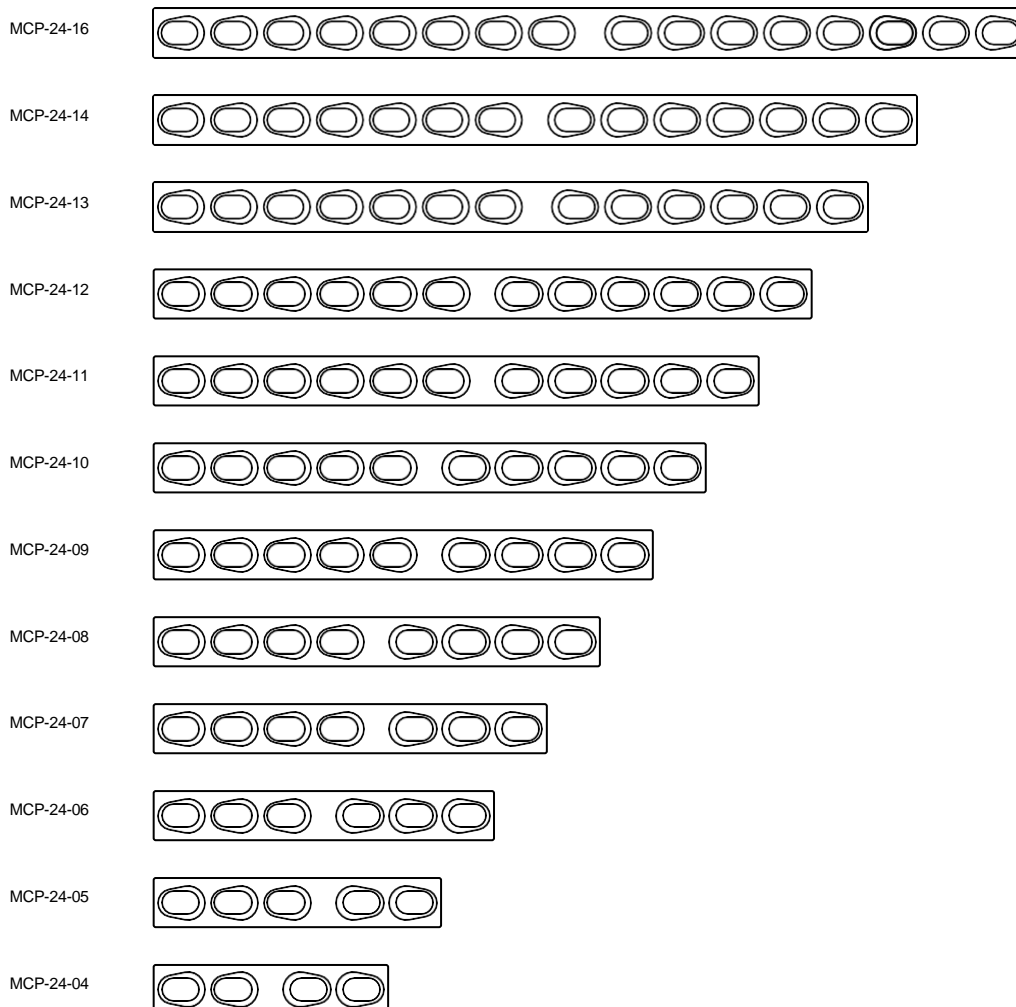

2.7mm Mini Self Compression Plate Thin

Order Code	No. of Holes	Length mm	RRP
MCP-27-02	2	21	£18.70
MCP-27-03	3	29	£20.40
MCP-27-04	4	37	£22.10
MCP-27-05	5	45	£23.80
MCP-27-06	6	53	£25.50



2.7mm Mini Self Compression Plate Thick

Order Code	No. of Holes	Length mm	RRP
MCP-27-07	7	61	£28.90
MCP-27-08	8	69	£30.60
MCP-27-09	9	77	£32.30
MCP-27-10	10	85	£34.00
MCP-27-11	11	93	£35.70
MCP-27-12	12	101	£37.40
MCP-27-13	13	109	£39.10
MCP-27-14	14	117	£40.80
MCP-27-15	15	125	£42.40
MCP-27-16	16	133	£44.10



Dimensions are 8mm wide, 2mm thick up to 6 holes and 2.5mm thick upwards. Use with 2.7mm Cortical Screws.

Self-compressing plates that achieve axial compression of the fracture site by combining screw hole geometry with screw insertion. Screws can be inserted off centre to the screw hole so that when tightened the head will glide alongside the hole displacing the plate in the direction of the fracture resulting in compression. They can adapt to many different internal fixation situations and function as a dynamic compression plate, a neutralization plate, or be used in bridging fashion as a lengthening plate. Use with ISO standard Cortical Bone Screws with spherical head.

All Plates are made from Stainless Steel ISO 5832-1

2.7mm Mini Self Compression Plate 2.0mm Thin

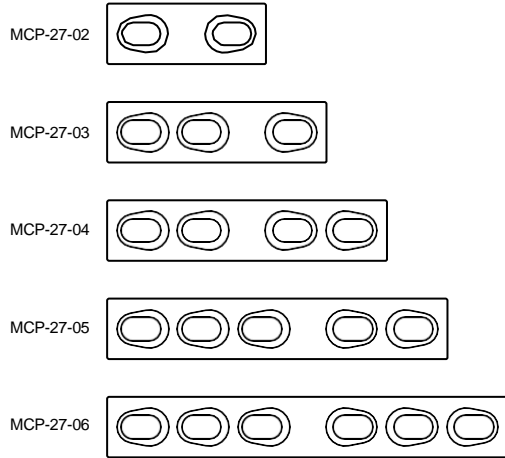

2.7mm Mini Self Compression Plate 2.5mm Thick

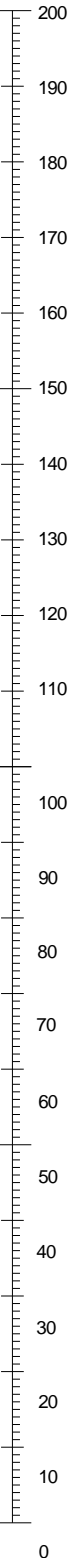
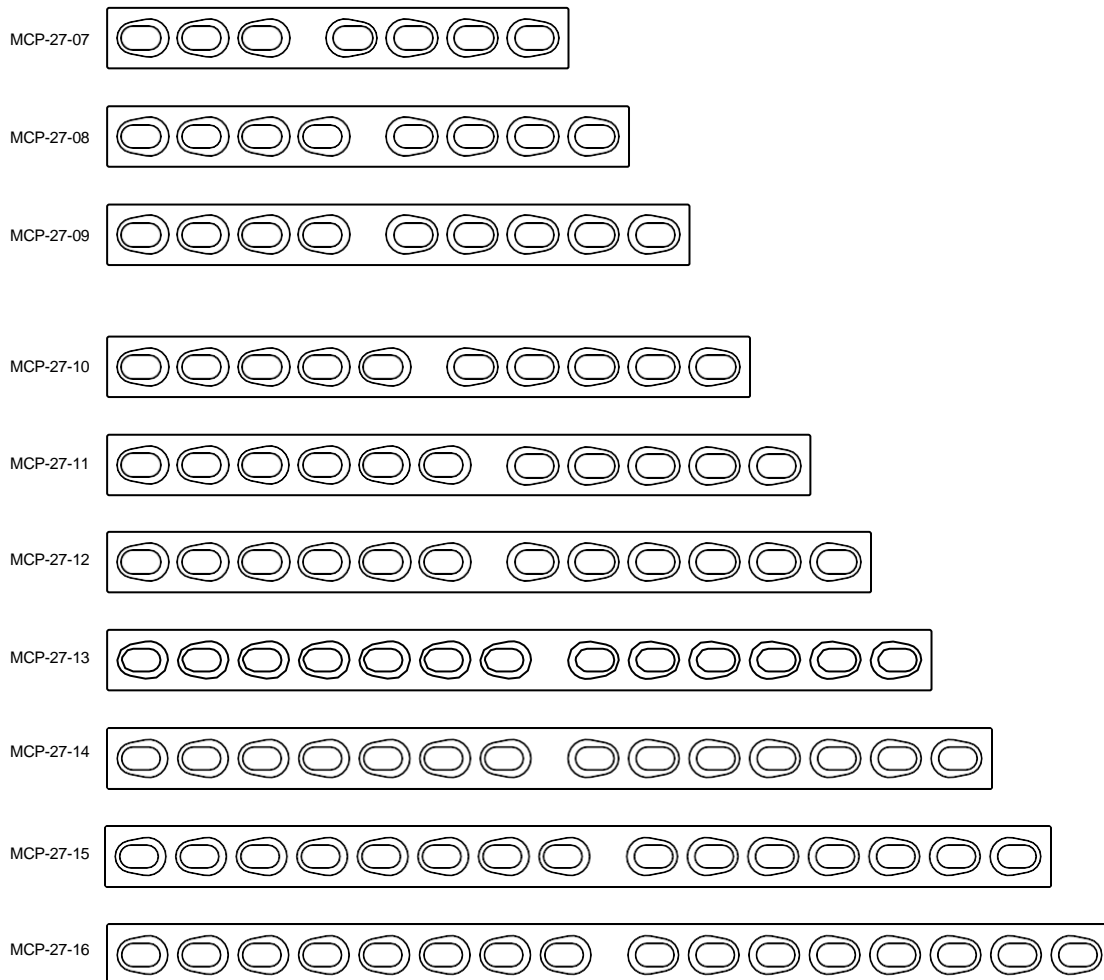

3.5mm Self Compression Plate Straight Narrow

Order Code	No. of Holes	Length mm	RRP
CPN-35-02	2	26	£20.40
CPN-35-03	3	38	£22.10
CPN-35-04	4	50	£23.80
CPN-35-05	5	62	£25.50
CPN-35-06	6	74	£27.20
CPN-35-07	7	86	£28.90
CPN-35-08	8	98	£30.60
CPN-35-09	9	110	£32.30
CPN-35-10	10	122	£34.00
CPN-35-11	11	134	£35.70
CPN-35-12	12	146	£37.40
CPN-35-13	13	158	£39.10
CPN-35-14	14	170	£40.80
CPN-35-15	15	182	£42.40
CPN-35-16	16	194	£44.10
CPN-35-17	17	206	£45.90
CPN-35-18	18	218	£47.50



Dimensions are 10.2mm wide, 3.2mm thick Pre contoured Profile. Use with 3.5mm Cortical Screws or 3.5mm/4mm Cancellous.

Self-compressing plates that achieve axial compression of the fracture site by combining screw hole geometry with screw insertion. Screws can be inserted off centre to the screw hole so that when tightened the head will glide alongside the hole displacing the plate in the direction of the fracture resulting in compression. They can adapt to many different internal fixation situations and function as a dynamic compression plate, a neutralization plate, or be used in bridging fashion as a lengthening plate. Use with ISO standard Cortical Bone Screws with spherical head.

All Plates are made from Stainless Steel ISO 5832-1

3.5mm Self Compression Plate Straight Narrow

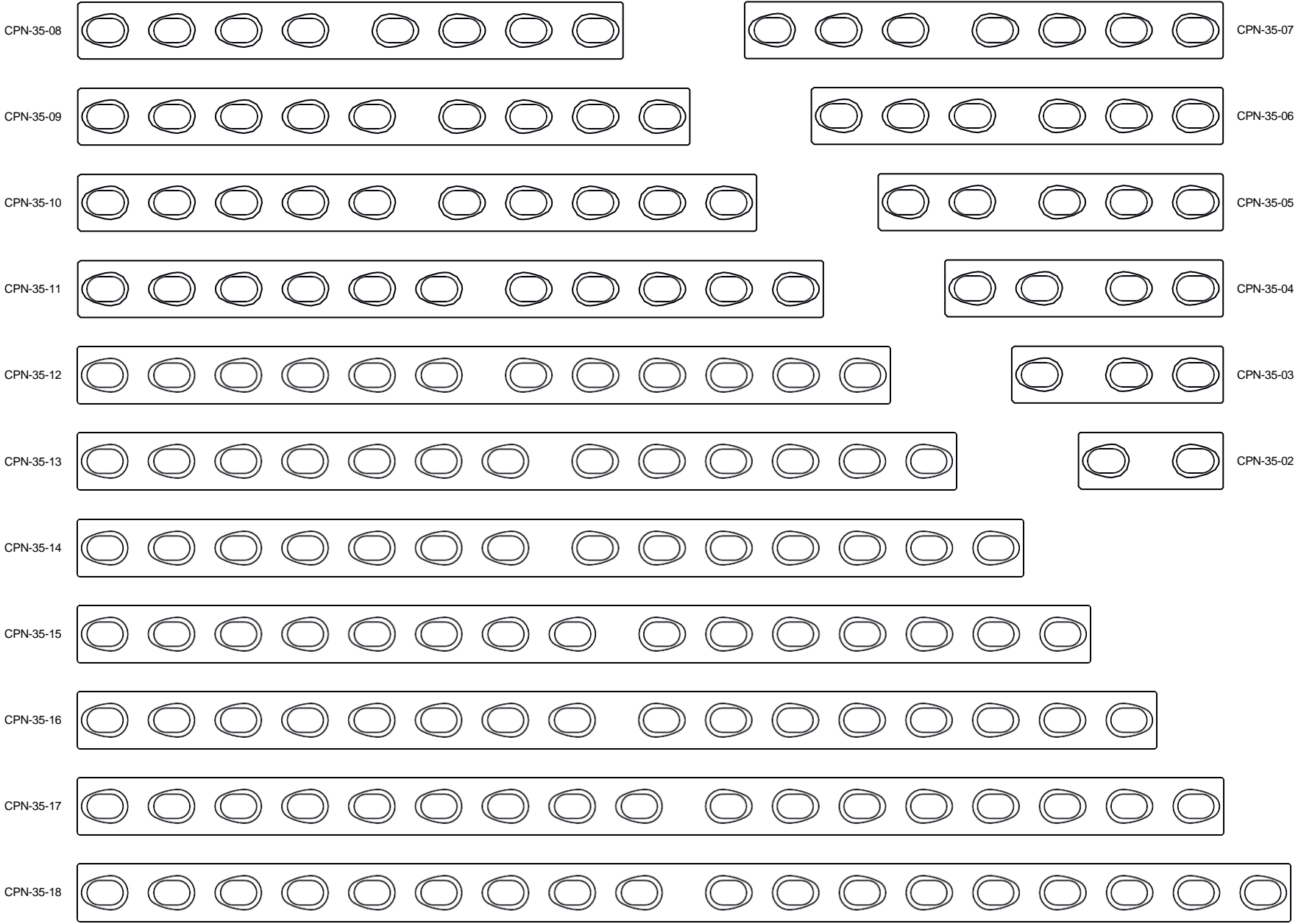

3.5mm Self Compression Plate Straight Broad

Order Code	No. of Holes	Length mm	RRP
CPB-35-02	2	26	£23.80
CPB-35-03	3	38	£27.20
CPB-35-04	4	50	£30.60
CPB-35-05	5	62	£34.00
CPB-35-06	6	74	£37.40
CPB-35-07	7	86	£40.80
CPB-35-08	8	98	£44.10
CPB-35-09	9	110	£47.50
CPB-35-10	10	122	£50.90
CPB-35-11	11	134	£54.30
CPB-35-12	12	146	£57.70
CPB-35-13	13	158	£61.10
CPB-35-14	14	170	£64.50
CPB-35-15	15	182	£67.90
CPB-35-16	16	194	£71.30
CPB-35-17	17	206	£74.70
CPB-35-18	18	218	£78.10
CPB-35-19	19	230	£81.50
CPB-35-20	20	242	£84.90
CPB-35-21	21	254	£88.20
CPB-35-22	22	266	£91.60



Dimensions are 11.5mm wide; 4mm thick Pre contoured Profile. Use with 3.5mm Cortical Screws or 3.5mm/4mm Cancellous.

Self-compressing plates that achieve axial compression of the fracture site by combining screw hole geometry with screw insertion. Screws can be inserted off centre to the screw hole so that when tightened the head will glide alongside the hole displacing the plate in the direction of the fracture resulting in compression. They can adapt to many different internal fixation situations and function as a dynamic compression plate, a neutralization plate, or be used in bridging fashion as a lengthening plate. Use with ISO standard Cortical Bone Screws with spherical head.

All Plates are made from Stainless Steel ISO 5832-1

Other sizes available on request.

3.5mm Self Compression Plate Straight Broad

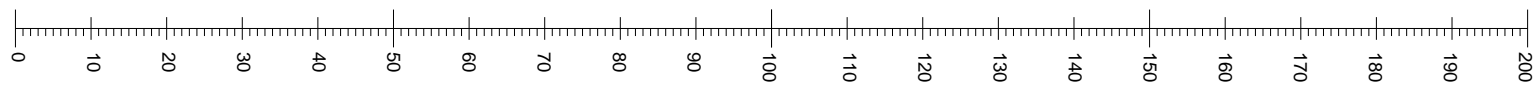
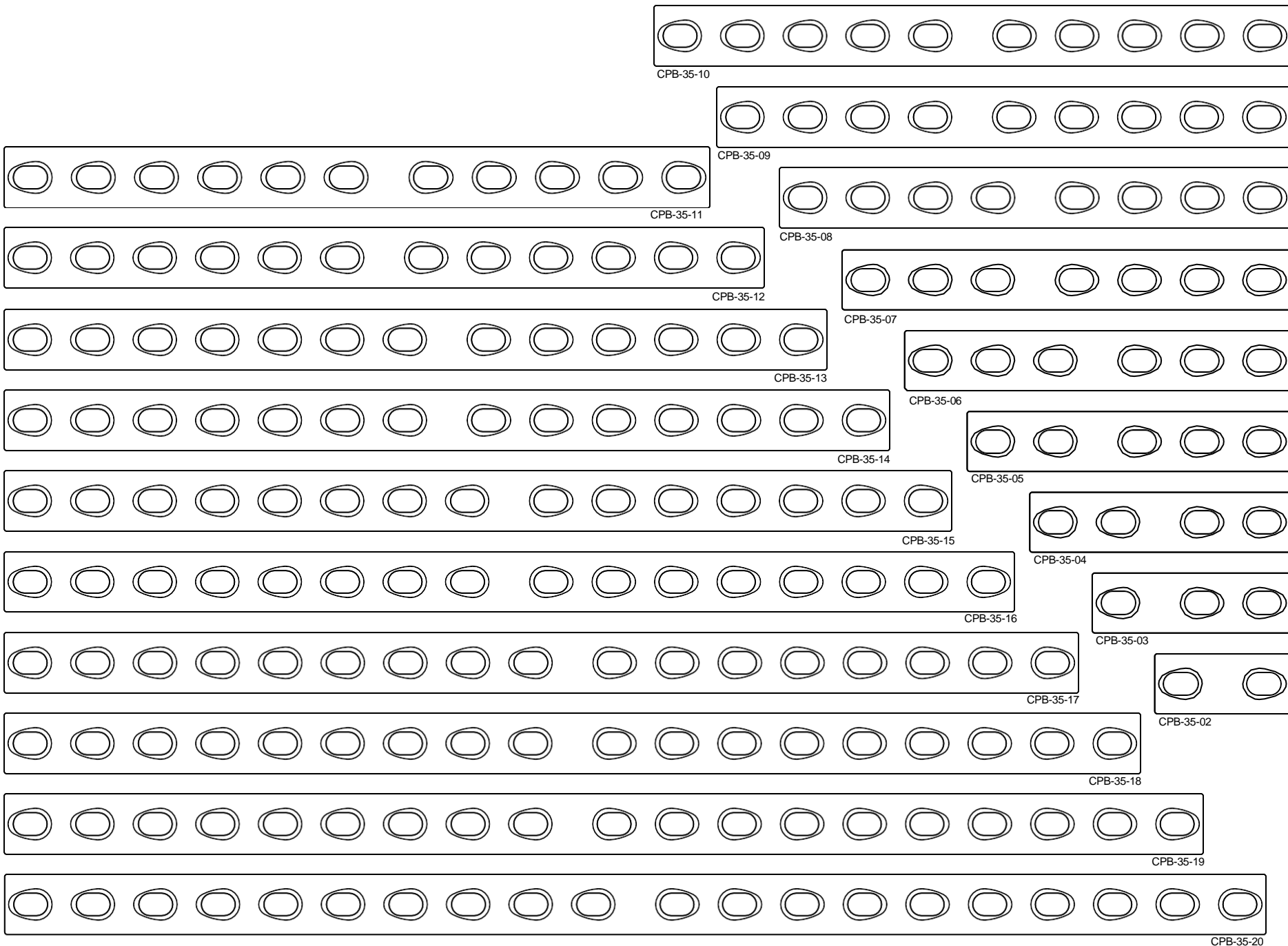

4.5mm Self Compression Plate Straight Narrow

Order Code	No. of Holes	Length mm	RRP
CPN-45-02	2	39	£17.00
CPN-45-03	3	55	£19.50
CPN-45-04	4	71	£22.10
CPN-45-05	5	87	£24.70
CPN-45-06	6	103	£27.20
CPN-45-07	7	119	£29.70
CPN-45-08	8	135	£32.30
CPN-45-09	9	151	£34.80
CPN-45-10	10	167	£37.40
CPN-45-11	11	183	£39.90
CPN-45-12	12	199	£42.40
CPN-45-13	13	215	£45.00
CPN-45-14	14	231	£47.50
CPN-45-15	15	247	£50.10
CPN-45-16	16	263	£52.60
CPN-45-17	17	279	£55.20
CPN-45-18	18	295	£57.70



Dimensions are 11.5mm wide; 4mm thick Pre contoured Profile. Use with 4.5mm Cortical Screws. 6.5mm End Cancellous screws.

Self-compressing plates that achieve axial compression of the fracture site by combining screw hole geometry with screw insertion. Screws can be inserted off centre to the screw hole so that when tightened the head will glide alongside the hole displacing the plate in the direction of the fracture resulting in compression. They can adapt to many different internal fixation situations and function as a dynamic compression plate, a neutralization plate, or be used in bridging fashion as a lengthening plate. Use with ISO standard Cortical Bone Screws with spherical head.

All Plates are made from Stainless Steel ISO 5832-1

4.5mm Self Compression Plate Straight Narrow

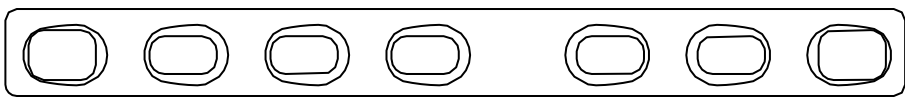

CPN-45-07



CPN-45-06

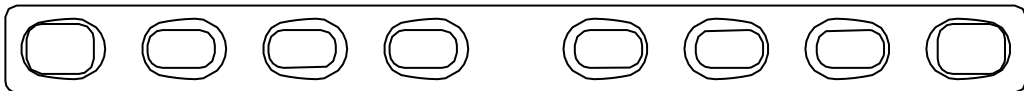

CPN-45-08



CPN-45-05



CPN-45-09



CPN-45-04



CPN-45-10

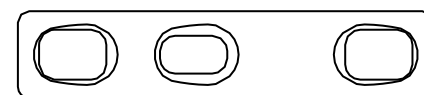

CPN-45-03

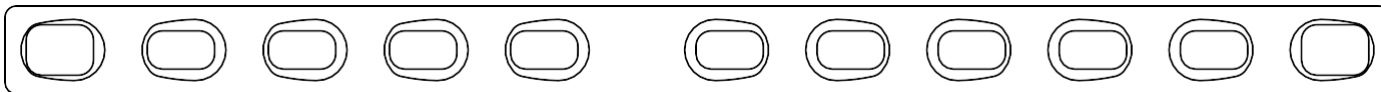

CPN-45-11

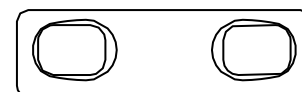

CPN-45-02

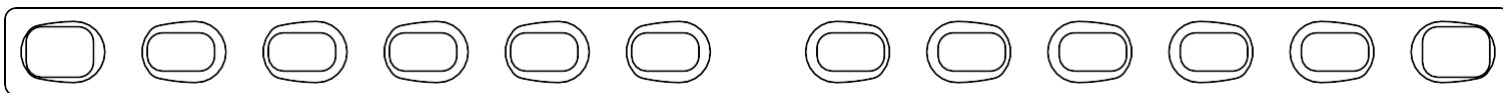

CPN-45-12

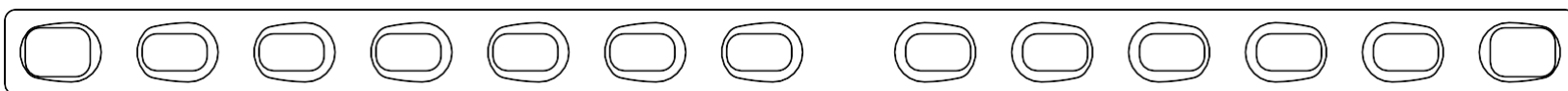

CPN-45-13

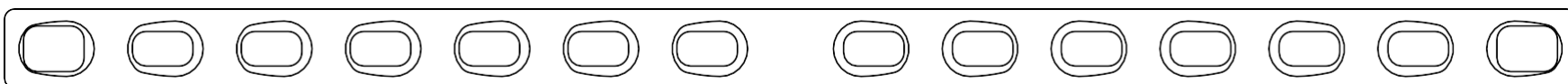

CPN-45-14

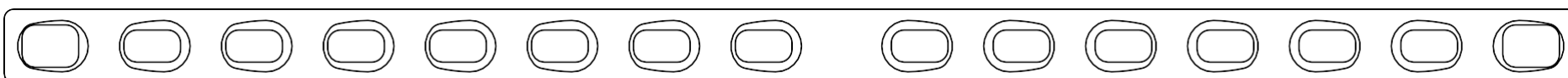

CPN-45-15

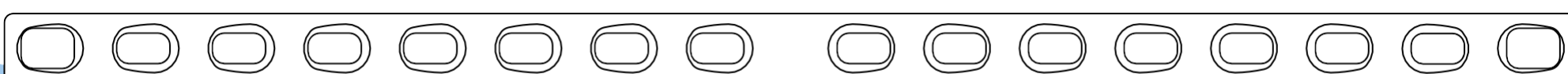

CPN-45-16

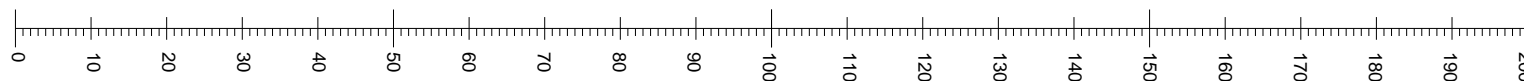



4.5mm Self Compression Plate Straight Broad

Order Code	No. of Holes	Length mm	RRP
CPB-45-05	5	87	£32.30
CPB-45-06	6	103	£34.80
CPB-45-07	7	119	£37.40
CPB-45-08	8	135	£39.90
CPB-45-09	9	151	£42.40
CPB-45-10	10	167	£45.00
CPB-45-11	11	183	£47.50
CPB-45-12	12	199	£50.10
CPB-45-13	13	215	£52.60
CPB-45-14	14	231	£55.20
CPB-45-15	15	247	£57.70
CPB-45-16	16	263	£60.30
CPB-45-17	17	279	£62.80
CPB-45-18	18	295	£65.30



Dimensions are 16.5mm wide; 4.5mm thick Pre contoured Profile. Use with 4.5mm Cortical Screws. 6.5mm End Cancellous screws.

Self-compressing plates that achieve axial compression of the fracture site by combining screw hole geometry with screw insertion. Screws can be inserted off centre to the screw hole so that when tightened the head will glide alongside the hole displacing the plate in the direction of the fracture resulting in compression. They can adapt to many different internal fixation situations and function as a dynamic compression plate, a neutralization plate, or be used in bridging fashion as a lengthening plate. Use with ISO standard Cortical Bone Screws with spherical head.

All Plates are made from Stainless Steel ISO 5832-1

Other sizes available on request.

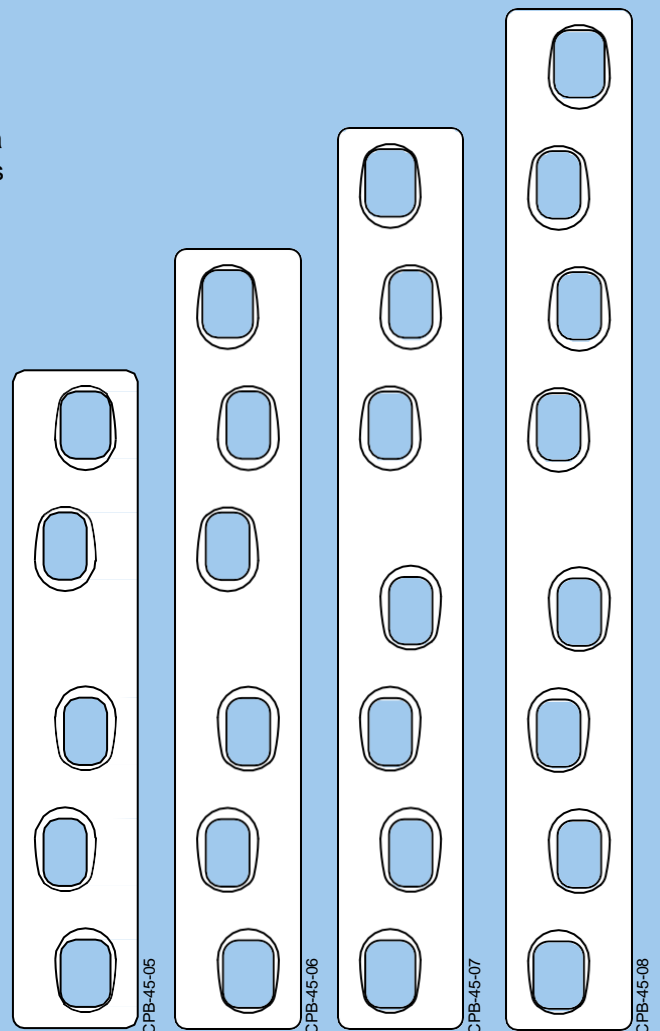

4.5mm Self Compression Plate Straight Broad

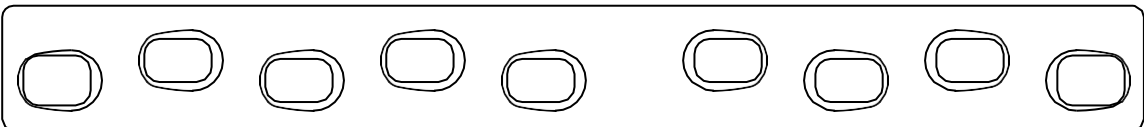

CPB-45-09

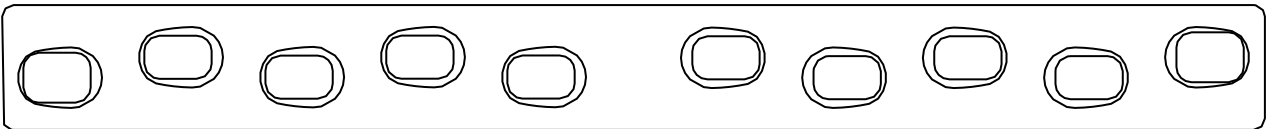

CPB-45-10

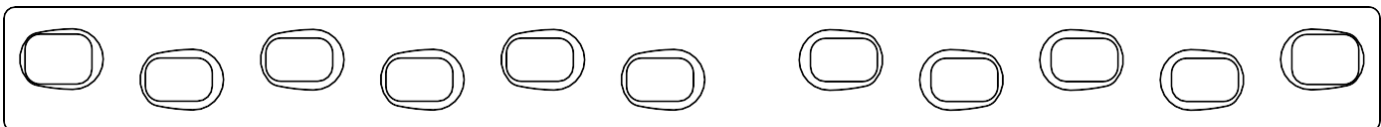

CPB-45-11

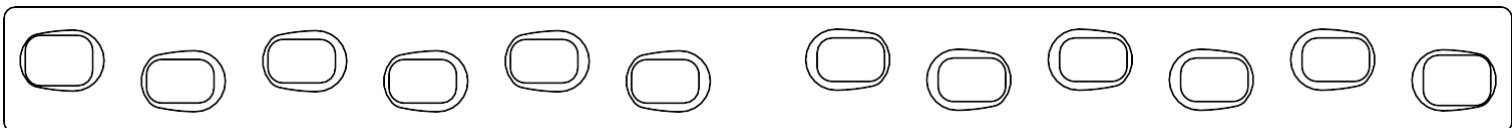

CPB-45-12

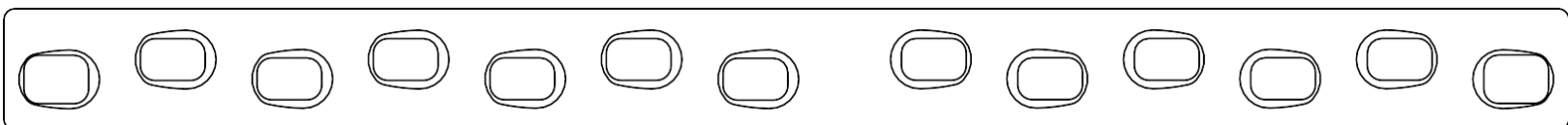

CPB-45-13

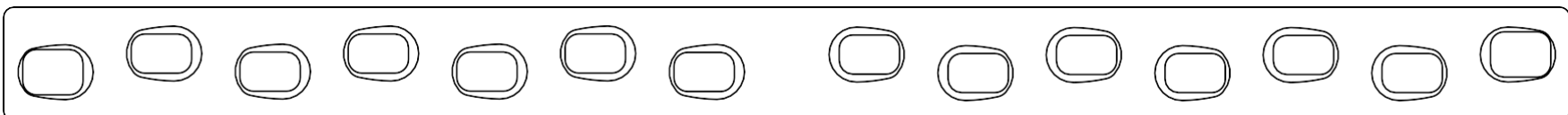

CPB-45-14

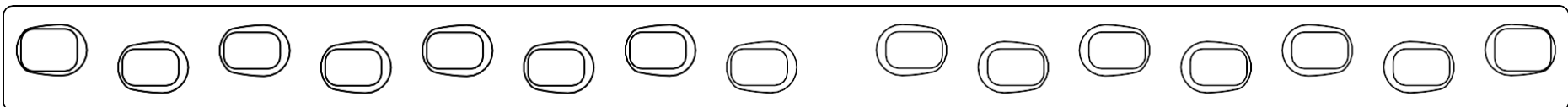

CPB-45-15

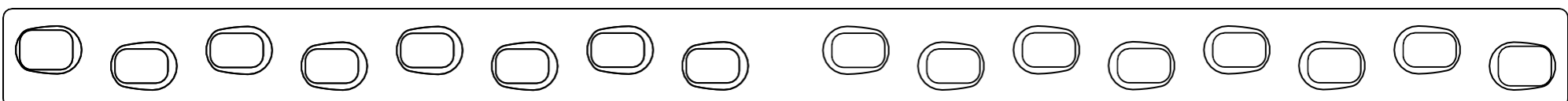

CPB-45-16

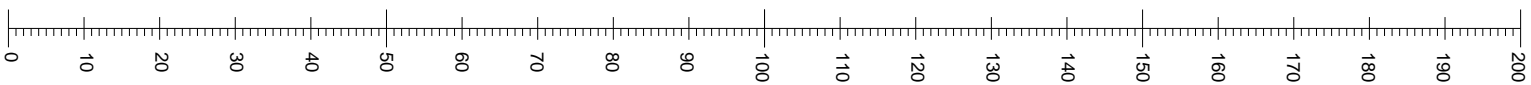



2.0/2.7/3.5/4.5mm Buttress Bridge Plate (Biological Healing Plate)

Order Code	No. of Holes	Length mm	RRP
BBP-20-07-060	7	60	£21.20
BBP-20-08-065	8	65	£21.70
BBP-20-08-070	8	70	£22.10

Order Code	No. of Holes	Length mm	RRP
BBP-27-06-063	6	63	£23.00
BBP-27-07-067	7	67	£23.40
BBP-27-07-073	7	73	£23.80
BBP-27-07-079	7	79	£24.20
BBP-27-08-075	8	75	£24.70
BBP-27-08-081	8	81	£25.10
BBP-27-08-085	8	85	£25.50

Order Code	No. of Holes	Length mm	RRP
BBP-35-07-120	7	120	£25.90
BBP-35-07-130	7	130	£26.30
BBP-35-07-142	7	142	£26.80
BBP-35-08-130	8	130	£27.20
BBP-35-08-142	8	142	£27.60
BBP-35-08-154	8	154	£28.00

Order Code	No. of Holes	Length mm	RRP
BBP-45-07-138	7	138	£35.70
BBP-45-07-151	7	151	£37.80
BBP-45-07-164	7	164	£40.30
BBP-45-08-150	8	150	£40.30
BBP-45-08-163	8	163	£42.40
BBP-45-08-176	8	176	£44.60

Biological Healing Plates (Buttress Bridge Plates)

2.0mm/2.7mm is 8mm wide by 2mm Thick.

3.5mm are 10.2mm wide by 3.2mm Thick Pre-contoured Profile.

4.5mm are 12mm by 4.0mm Thick Pre-Contoured Profile.

A plate that prevents axial deformity or deviation as a result of shearing or bending forces (central portion of plate has no screw holes to increase plate strength). They are also used to splint or bridge a fracture area to maintain the length of the bone. They can be used in conjunction with lag screws and can maintain alignment of highly comminute segments of bone (a fracture in which the bone is splintered or crushed into numerous pieces). Gaps in the bone may be present. When gaps are present, the plate with this type of fixation is subject to full loading. Therefore, every possible effort should be made to maintain soft tissue attachments and blood supply to the comminute fragments since union will depend on the formation of a callus bridge and not direct healing of the bone.

All Plates are made from Stainless Steel ISO 5832-1

2.0/2.7/3.5/4.5mm Buttress Bridge Plate (Biological Healing Plate)

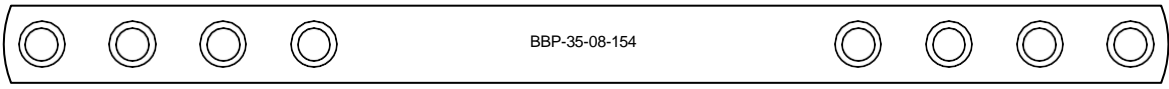

BBP-35-08-154

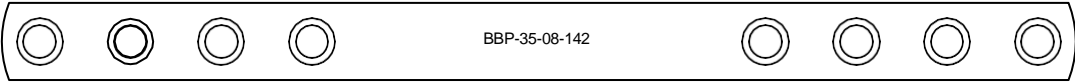

BBP-35-08-142

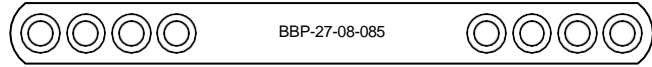

BBP-27-08-085

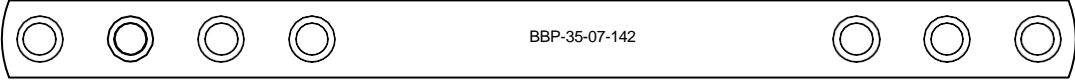

BBP-35-07-142

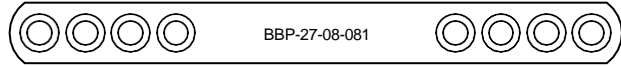

BBP-27-08-081

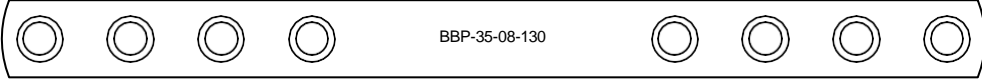

BBP-35-08-130

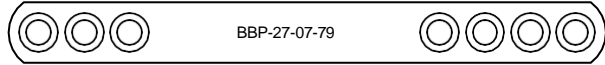

BBP-27-07-79

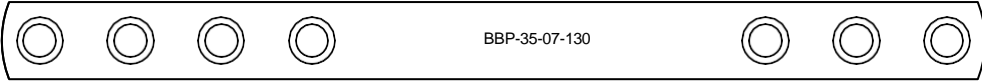

BBP-35-07-130

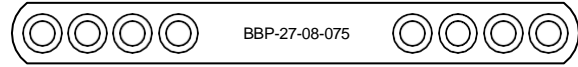

BBP-27-08-075



BBP-35-07-120

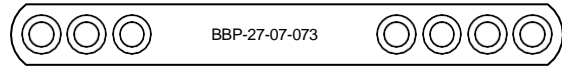

BBP-27-07-073



BBP-45-07-138

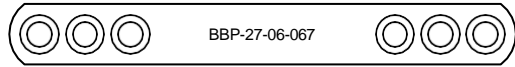

BBP-27-06-067

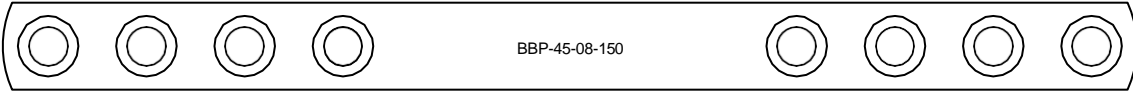

BBP-45-08-150

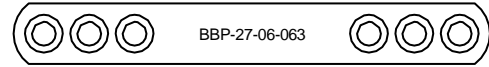

BBP-27-06-063

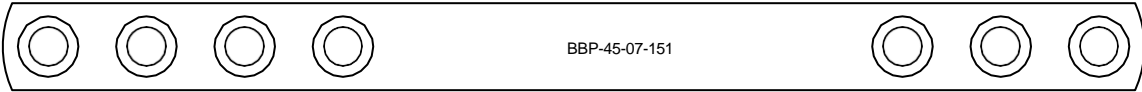

BBP-45-07-151

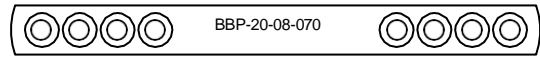

BBP-20-08-070

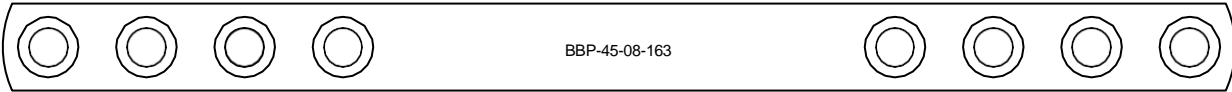

BBP-45-08-163

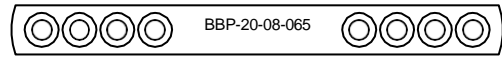

BBP-20-08-065

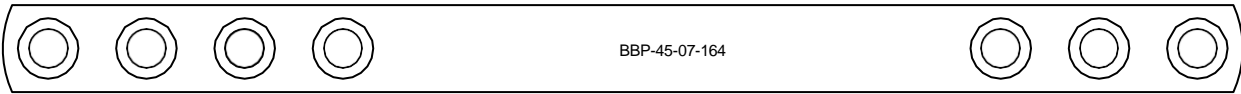

BBP-45-07-164

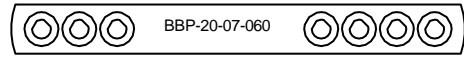

BBP-20-07-060

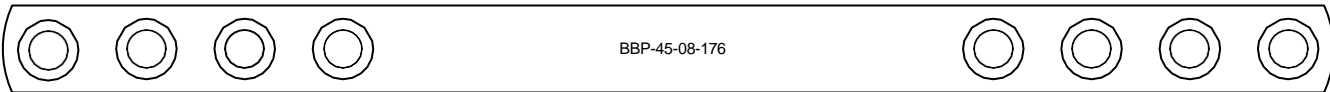

BBP-45-08-176

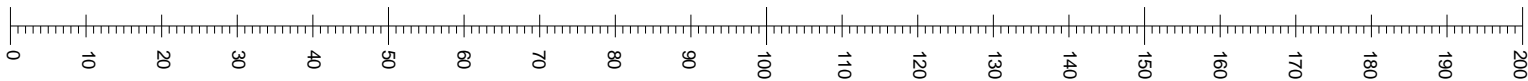



3.5mm Broad Buttress Bridge Plate (Biological Healing Plate)

Order Code	No. of Holes	Length mm	RRP
BBPX-35-08-130	8	130	£37.80
BBPX-35-07-130	7	130	£35.70
BBPX-35-08-142	8	142	£37.80
BBPX-35-07-142	7	142	£35.70
BBPX-35-08-154	8	154	£40.30
BBPX-35-07-154	7	154	£38.20

Biological Healing Plates (Buttress Bridge Plates)

3.5mm Broad are 11.5mm by 4.0mm Thick Pre-Contoured Profile

A plate that prevents axial deformity or deviation as a result of shearing or bending forces (central portion of plate has no screw holes to increase plate strength). They are also used to splint or bridge a fracture area to maintain the length of the bone. They can be used in conjunction with lag screws and can maintain alignment of highly comminute segments of bone (a fracture in which the bone is splintered or crushed into numerous pieces). Gaps in the bone may be present. When gaps are present, the plate with this type of fixation is subject to full loading. Therefore, every possible effort should be made to maintain soft tissue attachments and blood supply to the comminute fragments since union will depend on the formation of a callus bridge and not direct healing of the bone.

All Plates are made from Stainless Steel ISO 5832-1

3.5mm Broad Buttress Bridge Plate (Biological Healing Plate)

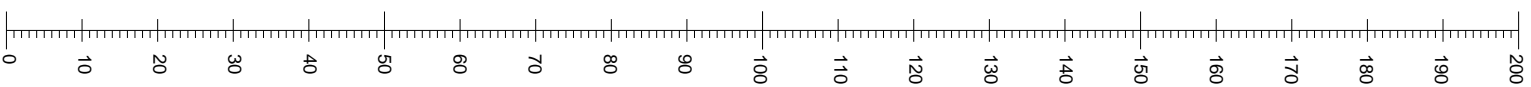
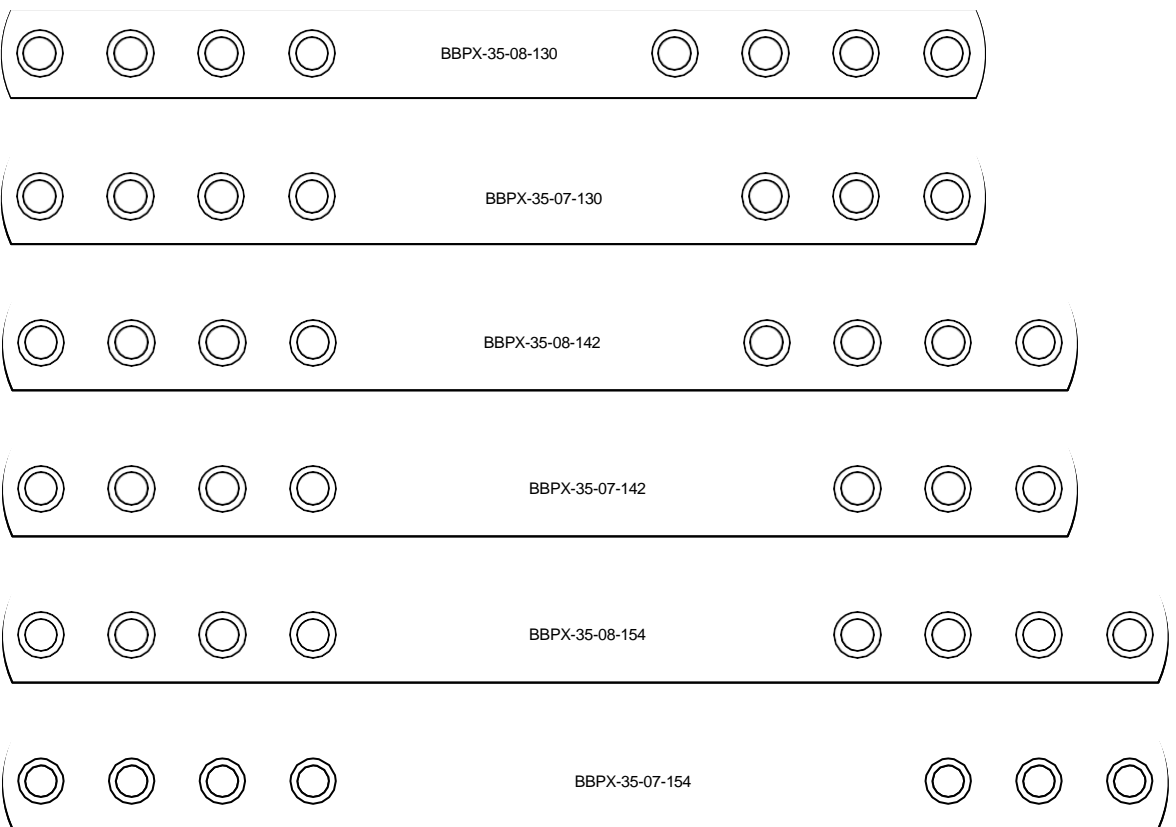



2.0mm Mini Plate Straight Tubular

Order Code	No. of Holes	Length mm	RRP
MPT-20-03	3	17	£23.80
MPT-20-04	4	23	£25.50
MPT-20-05	5	29	£27.20
MPT-20-06	6	35	£28.90
MPT-20-07	7	41	£30.60
MPT-20-08	8	47	£32.00



2.0mm Straight Tubular Compression Plate - Dimensions are 5mm wide, 1.1mm thick pre-contoured. Use with 2.0mm Cortical Screws.

The relative thickness of this plate facilitates closure of soft tissue over the plate and due to the tubular contoured plate design it lends itself well to high torsional and bending strengths.

2.7mm Quarter Tubular

Order Code	No. of Holes	Length mm	RRP
QTP-27-03	3	24	£10.20
QTP-27-04	4	32	£11.90
QTP-27-05	5	40	£13.60
QTP-27-06	6	48	£15.30
QTP-27-07	7	56	£17.00
QTP-27-08	8	64	£18.70



Quarter Tubular - Dimensions are 7mm wide, 1.1mm pre contoured. Use with 2.7mm Cortical Screws.

3.5mm One Third Tubular

Order Code	No. of Holes	Length mm	RRP
OTP-35-02	2	25	£13.30
OTP-35-03	3	37	£13.80
OTP-35-04	4	49	£14.90
OTP-35-05	5	61	£16.00
OTP-35-06	6	73	£17.10
OTP-35-07	7	85	£18.20
OTP-35-08	8	97	£19.30
OTP-35-09	9	109	£20.50
OTP-35-10	10	121	£21.60
OTP-35-11	11	133	£22.70



One third Tubular - Dimensions are 9mm wide, 1.1mm pre contoured. Use with 3.5mm Cortical Screws.

Used as a compression plate for smaller bones or metatarsals and metacarpals in larger breeds. The pre-contoured shape of the plate adds to the strengths even though it remains dimensionally thin. Compression is applied by eccentric positioning of the screw against the side of the screw hole furthest from the fracture line.

The relative thinness of this plate facilitates closure of soft tissue over the plate and due to the tubular contoured plate design it lends itself well to high torsional and bending strengths.

Stainless Steel ISO 5832-1

2.7mm Quarter Tubular

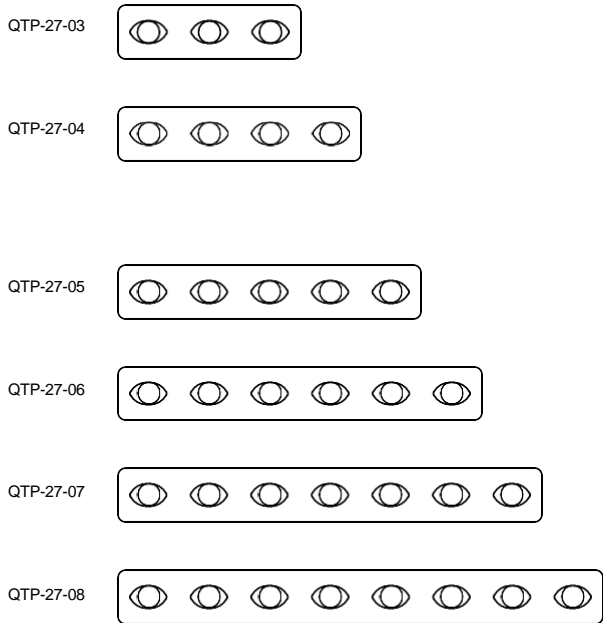

2.0mm Mini Plate Straight Tubular

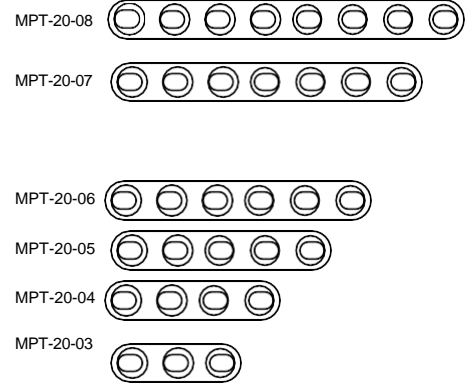

3.5mm One Third Tubular

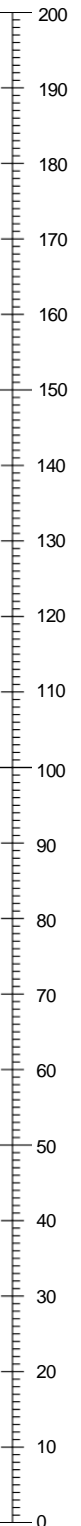
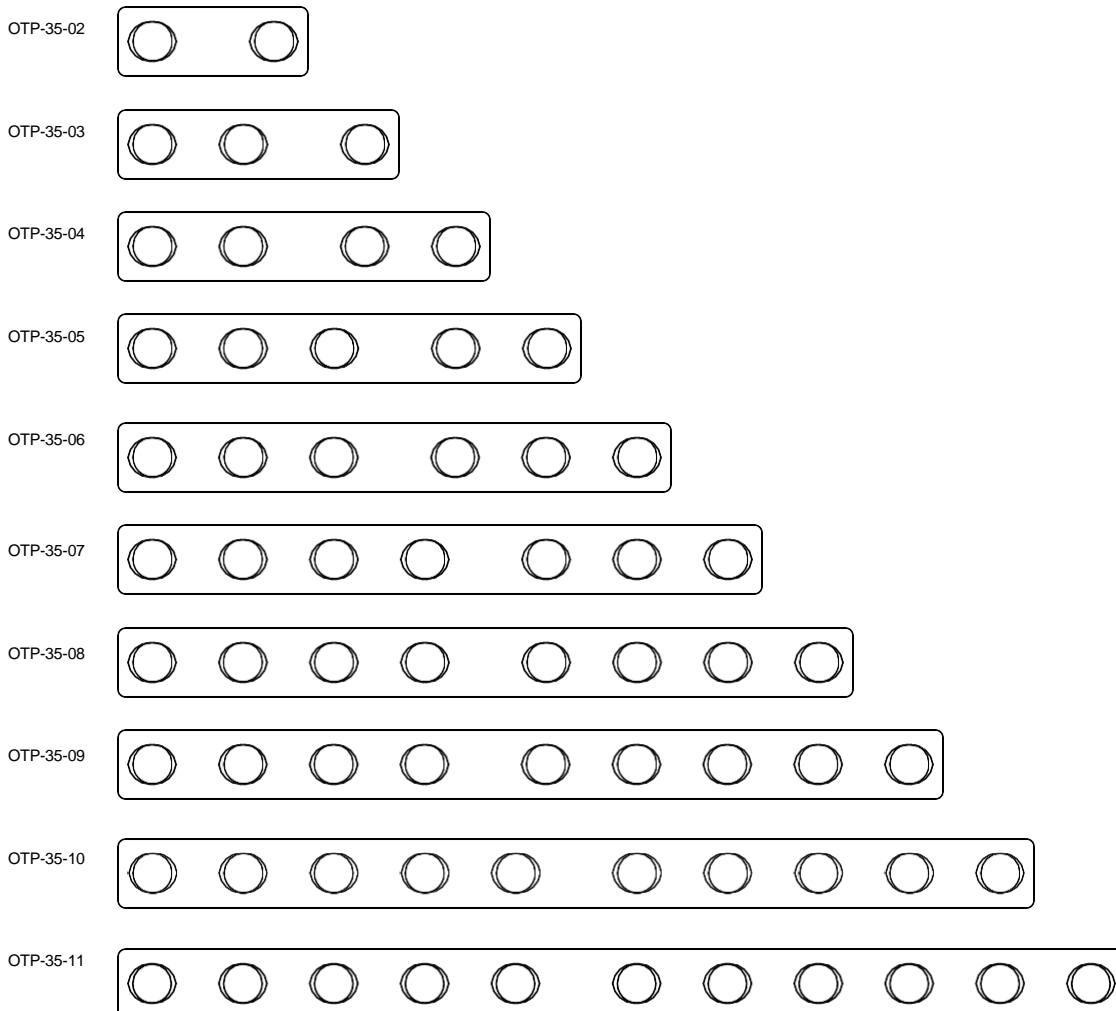



2.7mm Reconstruction Plates

Order Code	No. of Holes	Length	RRP
RCP-27-05	5	40	£32.30
RCP-27-06	6	48	£37.40
RCP-27-07	7	56	£39.90
RCP-27-08	8	64	£42.40
RCP-27-09	9	72	£45.00
RCP-27-10	10	80	£47.50
RCP-27-11	11	88	£52.60
RCP-27-12	12	96	£57.70

3.5mm Reconstruction Plates

Order Code	No. of Holes	Length	RRP
RCP-35-05	5	58	£40.80
RCP-35-06	6	70	£45.90
RCP-35-07	7	82	£50.90
RCP-35-08	8	94	£56.00
RCP-35-09	9	106	£61.10
RCP-35-10	10	118	£71.30
RCP-35-11	11	130	£85.50
RCP-35-12	12	142	£88.20

2.7mm Pre-contoured 8mm X 2mm Thick Notched

3.5mm Pre-contoured 8mm X 2.5mm Thick Notched

Specifically designed for easy three dimensional contouring but not exceeding more than 15 degrees in any one direction. The plate's stiffness is reduced by bending and if a strong curvature is needed, a pre contoured plate should be ordered. The longer plate lengths can be cut to size and we offer intermediate odd hole sizes on the 2.7mm and 3.5mm range.

Commonly used for stabilization of pelvic fractures.

These plates are not designed to withstand the forces of weight bearing.

All Plates are made from Stainless Steel ISO 5832-1

3.5mm Reconstruction Plates

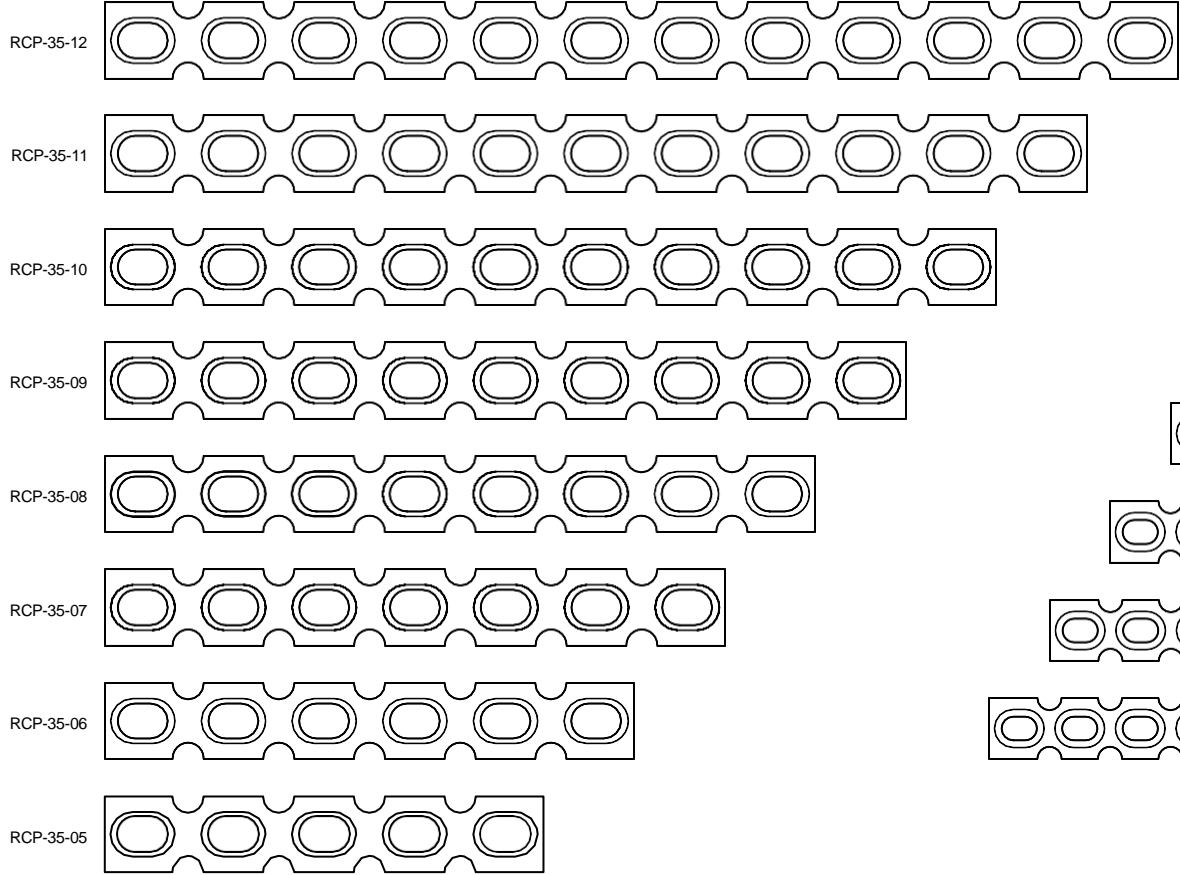

2.7mm Reconstruction Plates

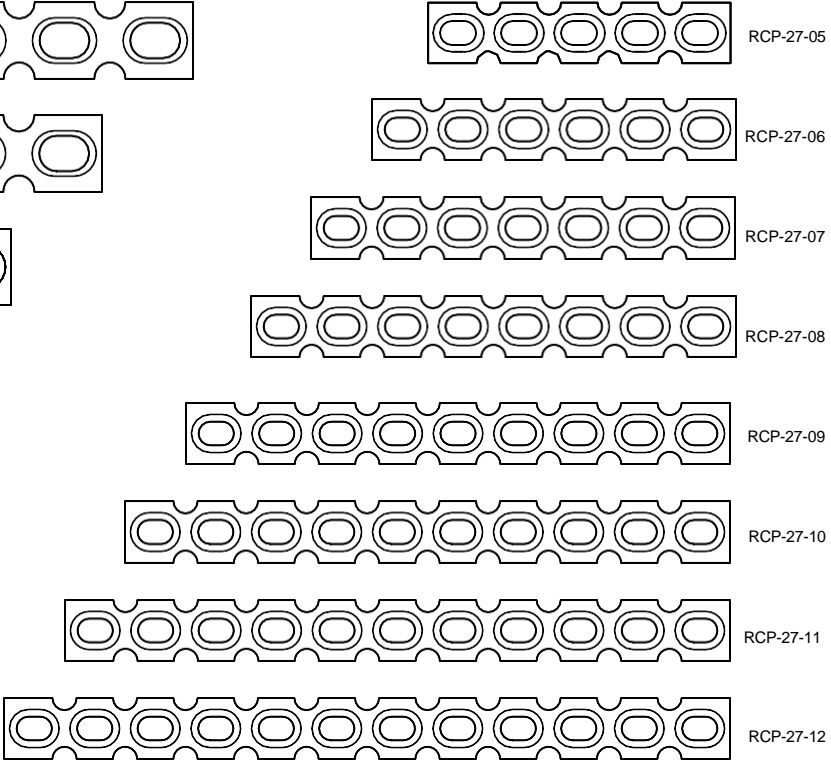



Cuttable Plates

Order Code	Length	No. of Holes	Screw Size	RRP
CUT-15-20-100	100mm	20	1.5	£42.40
CUT-15-30-120	120mm	30	1.5	£42.40
CUT-15-27-120	120mm	27	1.5	£42.40
CUT-20-27-150	150mm	27	2.0	£42.40
CUT-20-30-150	150mm	30	2.0	£42.40
CUT-24-27-150	150mm	27	2.4	£42.40
CUT-24-24-150	150mm	24	2.4	£42.40
CUT-27-22-150	150mm	22	2.7	£42.40
CUT-27-25-150	150mm	25	2.7	£42.40

Cuttable Malleable Plates

Order Code	Length	No. of Holes	Screw Size	RRP
CMP-20-30-150	150mm	30	2.0	£59.40
CMP-24-27-150	150mm	27	2.4	£59.40
CMP-27-25-150	150mm	25	2.7	£59.40

Veterinary Cuttable plates are used for internal fixation of long bone fractures in small dogs and cats and for smaller fracture procedures in larger breeds of dogs. Case studies have also been successful and widely accepted in repair of the metacarpals and metatarsals.

The Grooved Styled plates lends itself well to three dimensional contouring like a reconstruction plate.

Both styles of Plates can be cropped to size or stacked on top of each other for added strength. Each individual size plate has equal pitch between screw holes for easy alignment.

Suited to small sized screws.

All Plates are made from Stainless Steel ISO 5832-1

Broad Cuttable Plates

Order Code	Length	No. of Holes	Screw Size	RRP
CUT-15-30-120B	120mm	30	1.5	£43.60
CUT-15-27-120B	120mm	27	1.5	£43.60
CUT-20-30-150B	150mm	30	2.0	£43.60
CUT-20-27-150B	150mm	27	2.0	£43.60
CUT-24-27-150B	150mm	27	2.4	£43.60
CUT-24-24-150B	150mm	24	2.4	£43.60
CUT-27-25-150B	150mm	25	2.7	£43.60
CUT-27-22-150B	150mm	22	2.7	£43.60
CUT-24-54-300	300mm	54	2.4	£71.70
CUT-27-50-300	300mm	50	2.7	£71.70

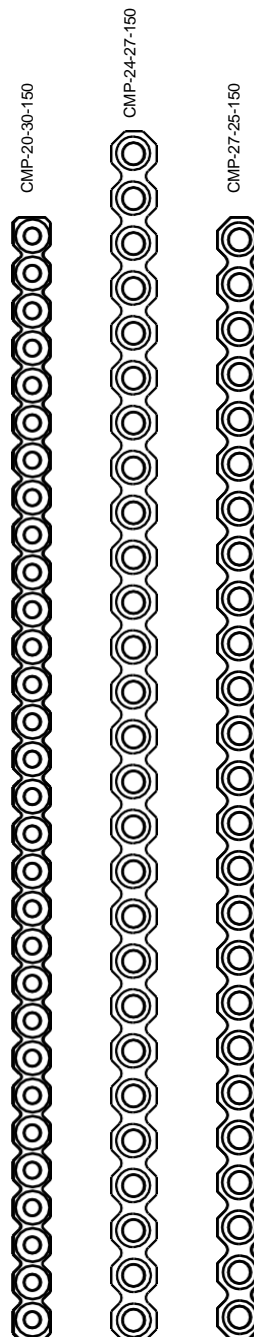

Cutable Plates



CUT-15-30-120



CUT-15-27-120



CUT-20-27-150



CUT-20-30-150



CUT-24-27-150



CUT-24-24-150



CUT-27-22-150

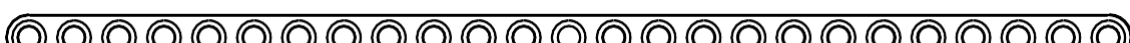

CUT-27-25-150



CUT-15-30-120B



CUT-15-27-120B



CUT-20-30-150B



CUT-20-27-150B



CUT-24-27-150B

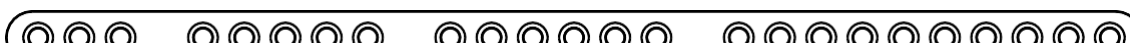

CUT-24-24-150B



CUT-27-25-150B

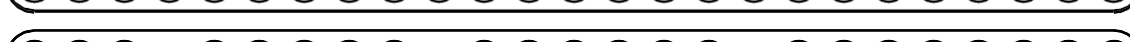

CUT-27-22-150B

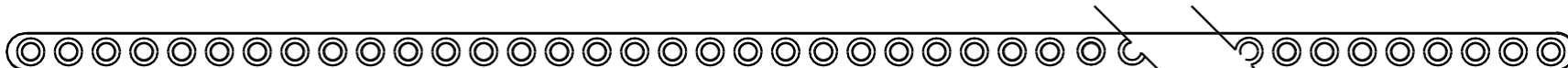

CUT-24-54-300



CUT-27-50-300

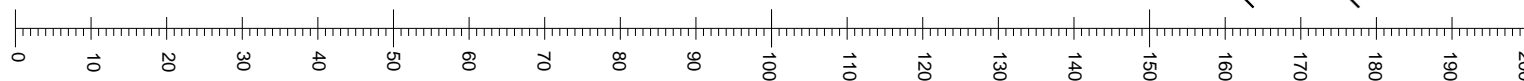



H-Plates

Order Code	No. of Holes	Length mm	RRP
H-15-4	4	8.9	£15.80
H-20-4	4	11.7	£21.60

2.0mm Distal Plates

Order Code	No. of Holes	Length mm	RRP
DRP-20-04-T	4	18	£14.90
DRP-20-05-T	5	24	£14.90
DRP-20-04-L	4	18	£14.90
DRP-20-04-R	4	18	£14.90
DRP-20-04-OL	4	18	£14.90
DRP-20-04-OR	4	18	£14.90

1.5mm Thick Plate.

An economical Plate can be used with 2.0mm Cortical Screws or

2.0mm Sherman Screws.

All Plates are made from Stainless Steel ISO 5832-1

2.7mm Distal Plates

Order Code	No. of Holes	Length mm	RRP
DRP-27-05-T	5	32	£16.60
DRP-27-06-T	6	39	£16.60
DRP-27-05-L	5	32	£16.60
DRP-27-05-R	5	32	£16.60
DRP-27-05-OL	5	32	£16.60
DRP-27-05-OR	5	32	£16.60

2mm Thick Plate.

An economical Plate can be used with 2.7mm Cortical Screws or

2.7mm (2.9mm) Sherman Screws.

All Plates are made from Stainless Steel ISO 5832-1

3.5 T-Plates Round Hole

Order Code	No. of Holes	Length mm	RRP
DRP-35-06-T	6	55	£29.70
DRP-35-07-T	7	77	£29.70
DRP-35-08-T	8	77	£29.70

3mm Thick Plate.

An economical Plate can be used with 3.5mm Cortical Screws or

9/64" Sherman Screws.

All Plates are made from Stainless Steel ISO 5832-1

Acetabular Plates

Order Code	No. of Holes	Length mm	RRP
ACE-20-04-0	4	19	£34.00
ACE-20-04-1	4	27	£34.00
ACE-24-04-6	4	21	£34.00
ACE-27-06-2	6	33	£34.00
ACE-27-06-3	6	34	£34.00
ACE-35-06-4	6	42	£42.40
ACE-35-06-5	6	46	£42.40

These plates were specifically designed for the stabilisation of acetabular fractures in dogs. The pre-contoured shape simplifies the contouring to the dorsal acetabular surface which facilitates accurate reduction of acetabular fractures.

Seven sizes to suit screw ranges from 2.0mm/2.4mm/2.7mm and 3.5mm. Holes are standard round.

Stainless Steel ISO 5832-1

H-Plates

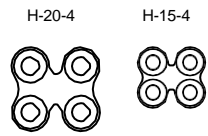

2.0mm Distal Plates

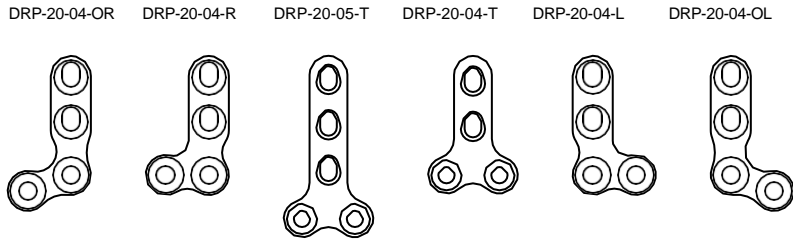

2.7mm Distal Plates

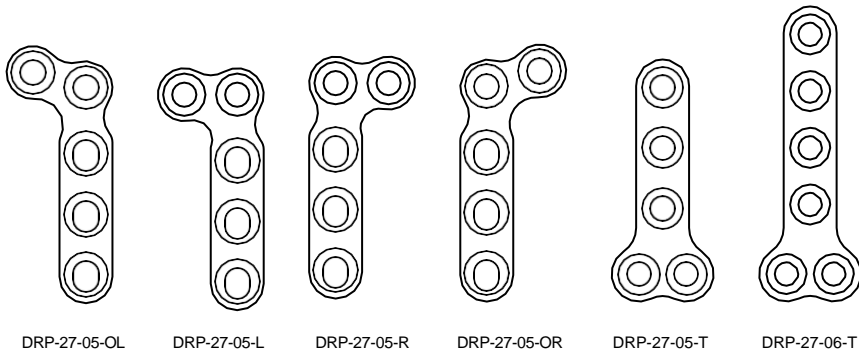

Acetabular Plates

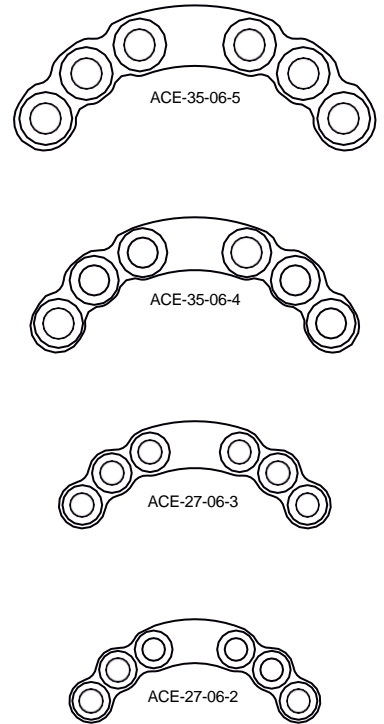

3.5 T-Plates Round Hole

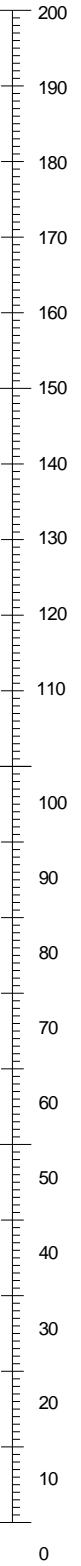
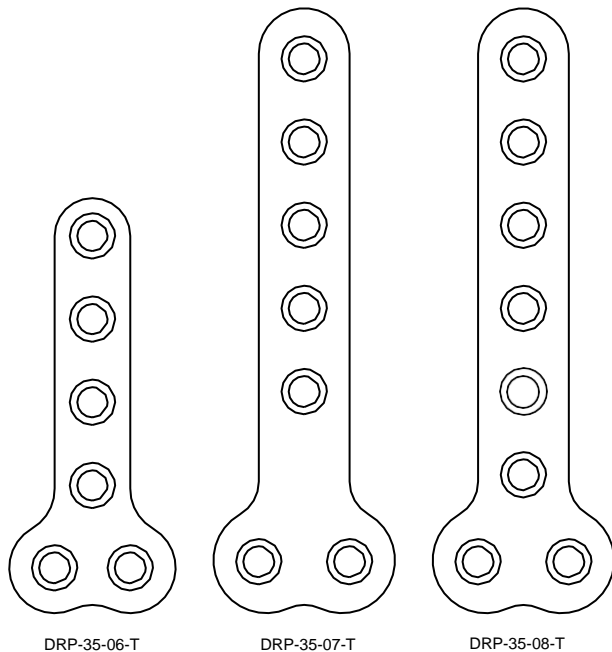



Hybrid T-Plates

Order Code	No. of Holes	Length mm	RRP
HTP-15-4-3	4 + 3	31	£25.40
HTP-15-5-3	5 + 3	34	£25.40
HTP-15-6-2	6 + 2	34	£27.20
HTP-15-6-3	6 + 3	34	£25.40
HTP-15-9-4	9 + 4	50	£34.20
HTP-20-4-2	4 + 2	35	£27.20
HTP-20-4-42	4 + 3	42	£27.20
HTP-20-4-49	4 + 3	49	£27.20
HTP-20-5-2	5 + 2	49	£27.20
HTP-20-5-3	5 + 3	49	£27.20
HTP-20-6-2	6 + 2	49	£27.20
HTP-20-7-3	7 + 3	63	£27.20
HTP-20-8-2	8 + 2	63	£29.10
HTP-20-9-4	9 + 4	50	£36.40
HTP-24-5-2	5 + 2	52	£27.20
HTP-24-5-3	5 + 3	57	£32.00
HTP-24-7-2	7 + 2	71	£27.20
HTP-24-9-4	9 + 4	81	£38.60
HTP-27-5-2	5 + 2	65	£32.30
HTP-27-5-3	5 + 3	68	£32.30
HTP-27-5-3XL	5 + 3	78	£32.30
HTP-27-7-2	7 + 2	85	£32.30
HTP-27-9-2	9 + 2	105	£36.80
HTP-35-5-3	5 + 3	78	£32.00

These comprehensive range of Plate designs helps overcome the limitations for screw placement in distal radius fractures

The plate head has smaller diameter round holes and are spaced closer together than the plate shaft and anatomically contoured the length of the plate.

To suit screw ranges from

1.5mm/2.0mm/2.4mm/2.7mm and 3.5mm. Head Holes are standard

Round with shaft.compression

Stainless Steel ISO 5832-1

Hybrid T-Plates

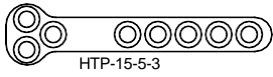

HTP-15-5-3

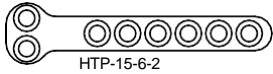

HTP-15-6-2

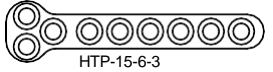

HTP-15-6-3



HTP-20-4-2

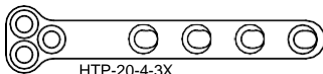

HTP-20-4-3X



HTP-20-4-3XL

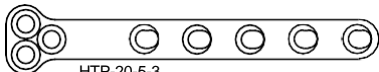

HTP-20-5-3



HTP-20-6-2

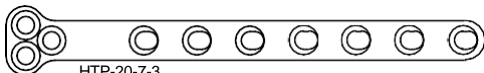

HTP-20-7-3

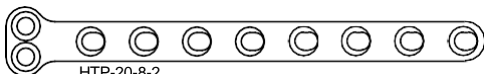

HTP-20-8-2

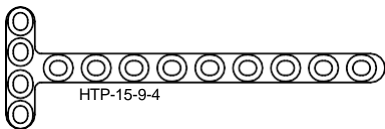

HTP-15-9-4

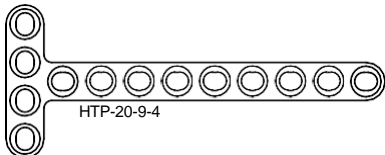

HTP-20-9-4

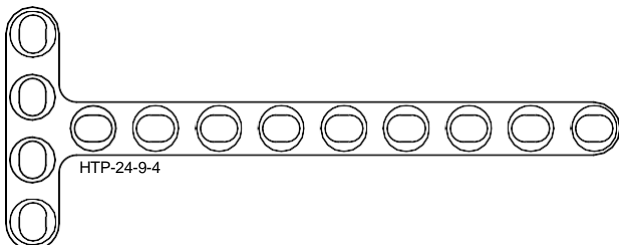

HTP-24-9-4

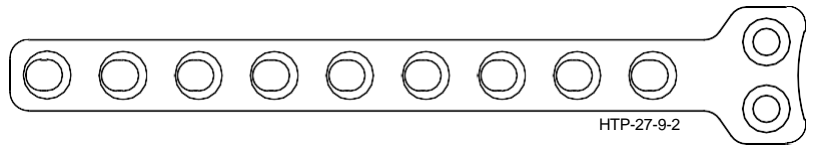

HTP-27-9-2

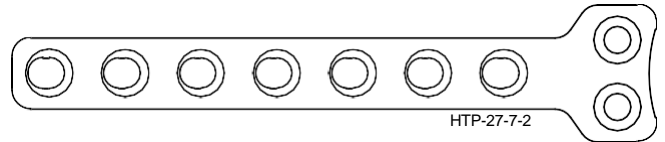

HTP-27-7-2

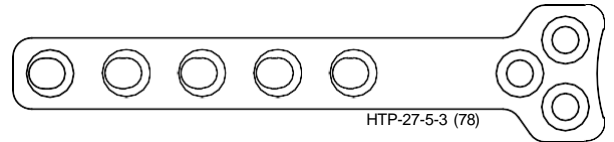

HTP-27-5-3 (78)

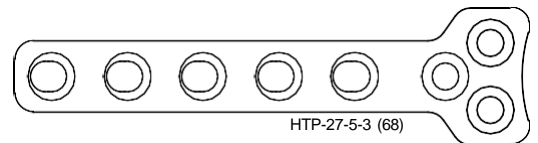

HTP-27-5-3 (68)

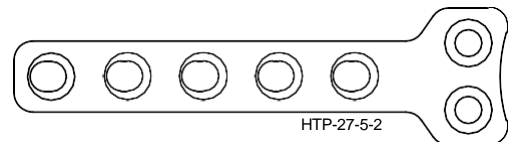

HTP-27-5-2

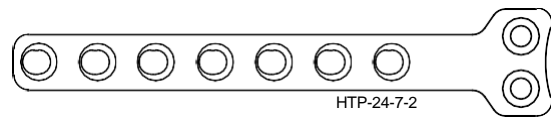

HTP-24-7-2

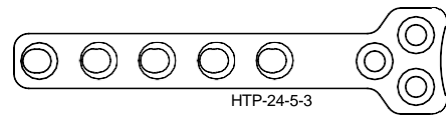

HTP-24-5-3

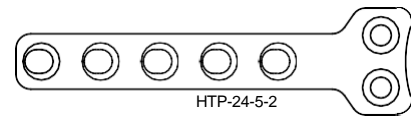

HTP-24-5-2

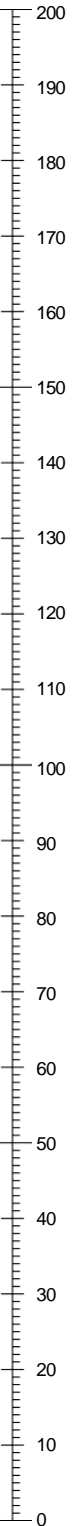

Pantarsal Arthrodesis Plates

Codes L=Left R=Right T=Tarsal Slot XS=Short

Order Code	Screw Size	Degrees	RRP
PAN-20-27-120-TL	2.0/2.7	120 Degrees with Tarsal Slot Left	£89.80
PAN-20-27-120-TR	2.0/2.7	120 Degrees with Tarsal Slot Right	£89.80
PAN-20-27-135-L	2.0/2.7	135 Degrees Left	£83.20
PAN-20-27-135-R	2.0/2.7	135 Degrees Right	£83.20
PAN-20-27-135-TL	2.0/2.7	135 Degrees. With Tarsal Slot Left	£89.80
PAN-20-27-135-TR	2.0/2.7	135 Degrees. With Tarsal Slot Right	£89.80
PAN-27-35-135-L	2.7/3.5	135 Degrees Left	£83.20
PAN-27-35-135-L-XS	2.7/3.5	135 Degrees. Short Left	£83.20
PAN-27-35-135-R	2.7/3.5	135 Degrees Right	£83.20
PAN-27-35-135-R-XS	2.7/3.5	135 Degrees. Short Right	£83.20
PAN-27-35-135-TL	2.7/3.5	135 Degrees. With Tarsal Slot Left	£89.80
PAN-27-35-135-TL-XS	2.7/3.5	135 Degrees. With Tarsal Slot. Short Left	£89.80
PAN-27-35-135-TR	2.7/3.5	135 Degrees. With Tarsal Slot Right	£89.80
PAN-27-35-135-TR-XS	2.7/3.5	135 Degrees. With Tarsal Slot. Short Right	£89.80
PAN-35-45-135-TL	3.5/4.5	135 Degrees. With Tarsal Slot Left	£121.30
PAN-35-45-135-TR	3.5/4.5	135 Degrees. With Tarsal Slot Right	£121.30

Arthrodesis is an elective surgical procedure to eliminate motion in a joint by providing a bony fusion. The procedure is used for several specific purposes: to relieve pain; to provide stability; to overcome postural deformity resulting from neurologic deficit; and to halt advancing disease.

Designed in Canine (135°) and in Feline (120°) for a functional position.

All Plates are made from Stainless Steel ISO 5832-1

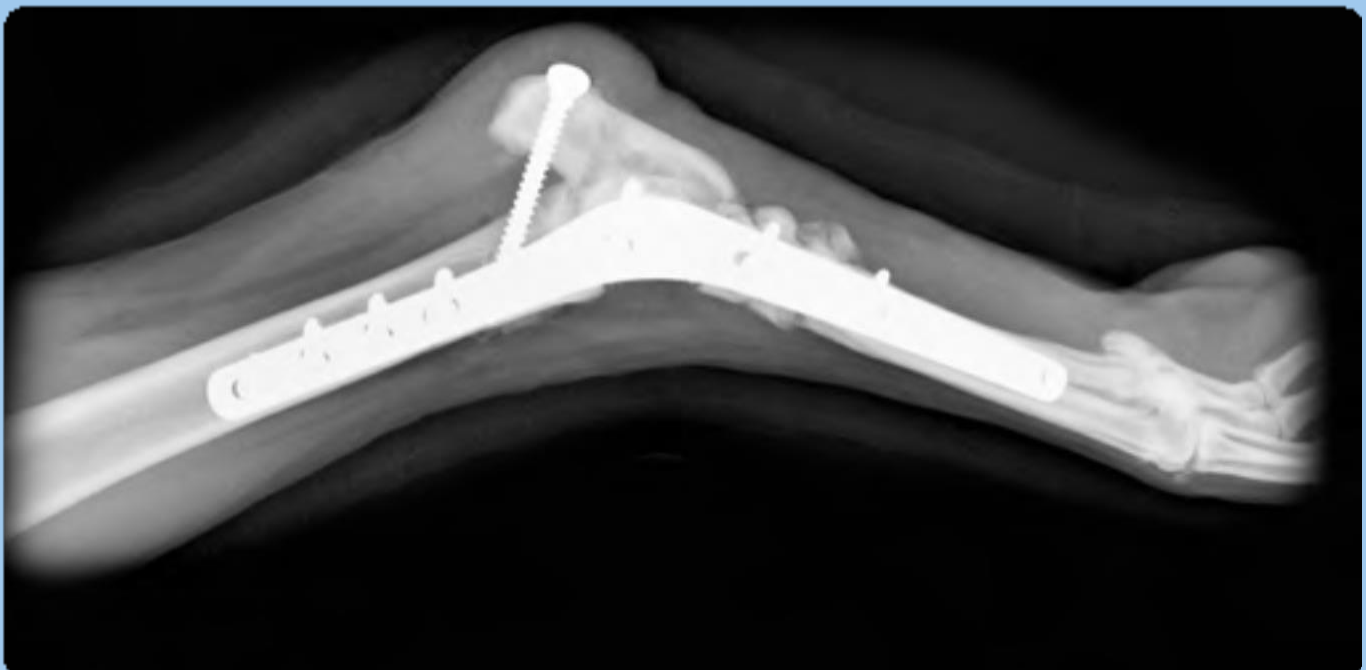

Pantarsal Arthrodesis Plates

Canine 135°

Feline 120°

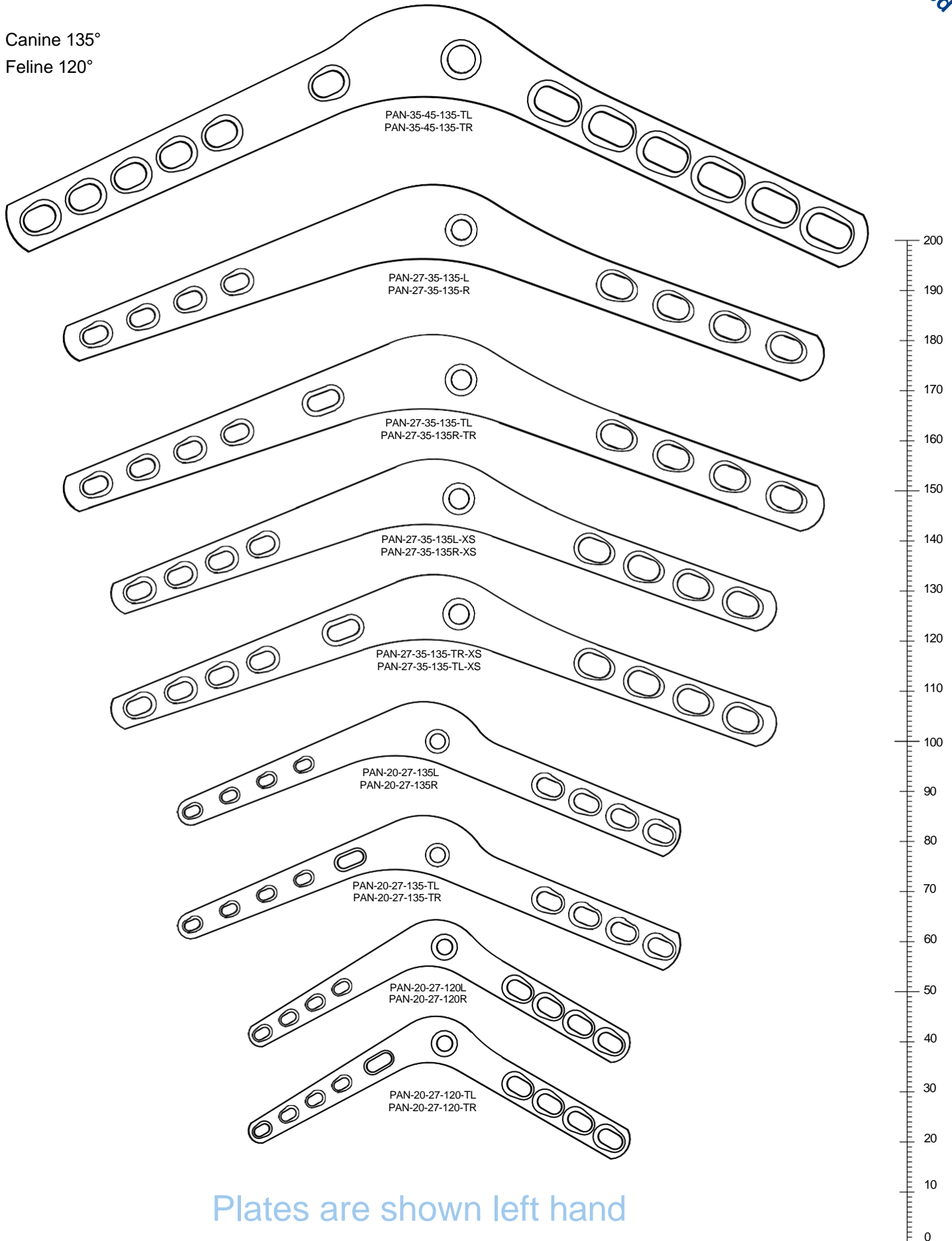

Plates are shown left hand



Canine Cranial Pantarsal Arthrodesis Plate

Order Code	Screw Size	RRP
CPA-27-35-140	2.7 / 3.5	£110.30
CPA-20-27-140	2.0 / 2.7	£93.80

3.5mm/2.7mm Pre contoured to 135° to reduce stress risers. Profile 12mm X 4 MM for added strength. 140°

2.0/2.4/2.7mm Pre contoured to 140° to reduce stress risers. Profile 8mm X 2.5MM for added strength. 140°

An improved plate with increased screw placement angulation in elliptical slots similar in design of Limited contact slots. The oblique undercut for improved range of inclination either side of the bend greatly improves screw placement to secure the talus.

New range has the added advantage of reduce profile height to aid closure without affecting torsional strength.

Larger compression slots in the Tibia than the metatarsal and tapered to suit.

All Plates are made from Stainless Steel ISO 5832-1



Feline Pantarsal Plate Cranial Position

Order Code	Screw Size	RRP
CPA-20-20-120	2.0 / 2.0	£83.20
CPA-20-24-120	2.0 / 2.4	£83.20
CPA-20-27-120	2.0 / 2.7	£83.20

2.0mm/2.0mm Dimensions are 5mm wide by 2mm thick, tapering to 1.5mm pre bent at 120° to reduce stress risers.

2.0mm/2.4mm Dimensions are 6.5mm wide by 2mm thick, tapering to 1.5mm pre bent at 120° to reduce stress risers.

2.0mm/2.0mm Dimensions are 8mm wide by 2mm thick, tapering to 1.5mm pre bent at 120° to reduce stress risers.

Larger compression slots in the Tibia than the metatarsal and tapered to suit.

All Plates are made from Stainless Steel ISO 5832-1



Canine Cranial 140° Pantarsal Arthrodesis Plates

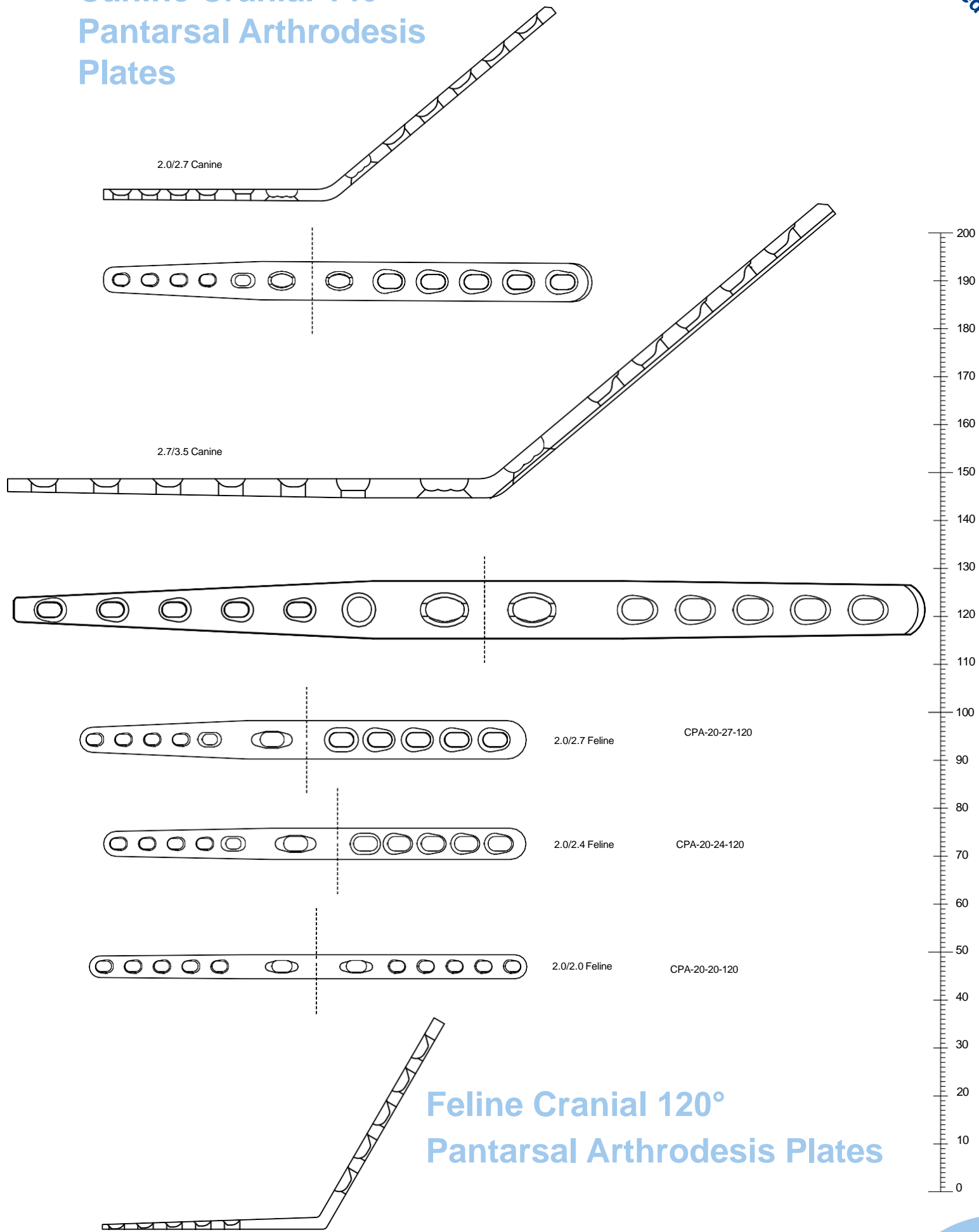

2.0/2.7 Feline CPA-20-27-120

2.0/2.4 Feline CPA-20-24-120

2.0/2.0 Feline CPA-20-20-120

Feline Cranial 120° Pantarsal Arthrodesis Plates

Partial Carpal Arthrodesis Plate

Order Code	Length mm	Ø Screw mm	RRP
PCA-27-35	65	2.7/3.5	£45.90
PCA-20-24-27	51	2.0/2.4/2.7	£47.50
PCA-15-20	35	1.5/2.0	£49.20

Is used to treat subluxation of the carpometacarpal joint occurring without disruption and displacement of the accessory carpal and ulna carpal bones.

Three sizes available with a 5 degree incline on the head of the reduced sized head.

All Plates are made from Stainless Steel ISO 5832-1

Pancarpal Arthrodesis Plates DCP Style

Order Code	Length mm	Ø Screw mm	RRP
PAD-15-20	53	1.5/2.0	£48.80
PAD-15-20L	61	1.5/2.0	£50.90
PAD-20-20	57	2.0/2.0	£50.90
PAD-20-20L	67	2.0/2.0	£53.10
PAD-20-27	75	2.0/2.7	£53.10
PAD-20-27L	90	2.0/2.7	£55.20
PAD-20-27-PB	75 pre-bent	2.0/2.7	£66.20
PAD-24-27L	95	2.4/2.7	£57.30
PAD-27-35	101	2.7/3.5	£57.30
PAD-27-35L	118	2.7/3.5	£57.30
PAD-27-35-PB	101 pre-bent	2.7/3.5	£66.20
PAD-27-35L-PB	118 pre-bent	2.7/3.5	£66.20
PAD-35-35	141	3.5/3.5	£59.40
PAD-35-35L	154	3.5/3.5	£63.60
PAD-35-45	185	3.5/4.5	£123.00

Is used to treat subluxations or luxations of the middle carpal and carpometacarpal joints which are associated with disruption of the accessory carpal ligaments, palmar fibrocartilage and palmar ligaments.

Sizes using 1.5mm Cortical screws to a heavy duty 4.5mm Cortical Screw. Available in round hole versions and Compression slots.

All Plates are made from Stainless Steel ISO 5832-1

Pancarpal Arthrodesis Plates Round Holes

Order Code	Length mm	Ø Screw mm	RRP
PAR-20-27	75	2.0/2.7	£40.80
PAR-27-35	101	2.7/3.5	£40.80
PAR-27-35L	118	2.7/3.5	£40.80
PAR-35-35	141	3.5/3.5	£40.80

Locking Pancarpal Arthrodesis

Order Code	Description	Length mm	Ø Screw mm	RRP
LPA-35-DCP	3.5mm Locking and DCP	154	3.5 Lock+3.5	£126.80
LPA-2735-DCP	Mix of 2.7/3.5mm Locking and DCP's	118	2.7/3.5 Lock+2.7/3.5	£126.80

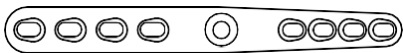

PAD-15-20

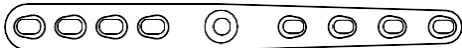

PAD-15-20L



PAD-20-20

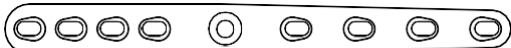

PAD-20-20L

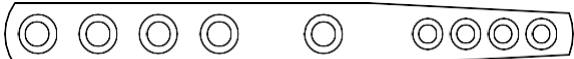

PAR-20-27

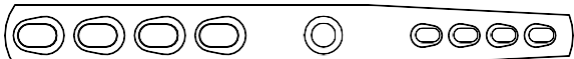

PAD-20-27

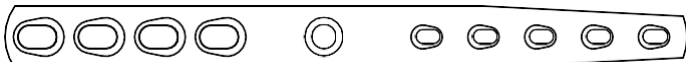

PAD-20-27L

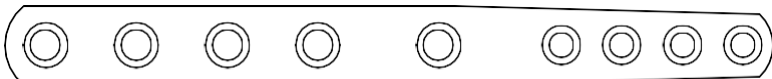

PAR-27-35

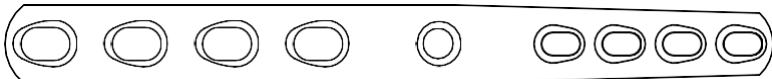

PAD-27-35

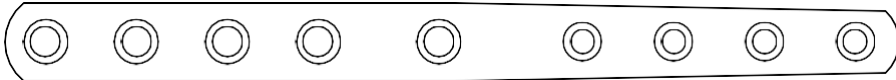

PAR-27-35L

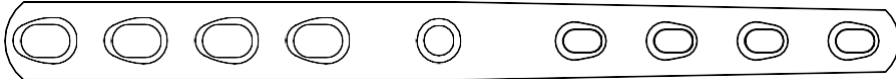

PAD-27-35L

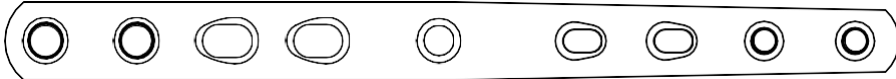

LPA-2735-DCP



PAR-35-35



PAD-35-35



PAD-35-35L

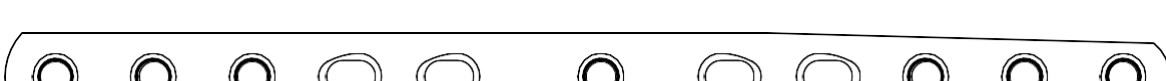

LPA-35-DCP

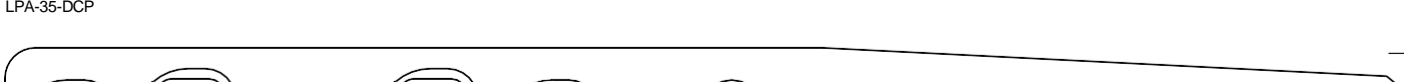

PAD-35-45

PCA-15-20

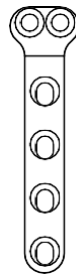

PCA-20-24-27

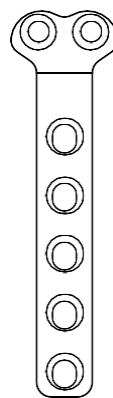

PCA-27-35

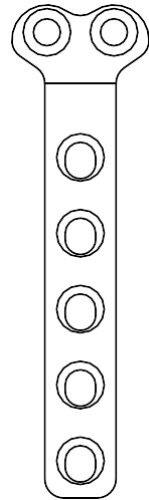

Pancarpal Arthrodesis Plates

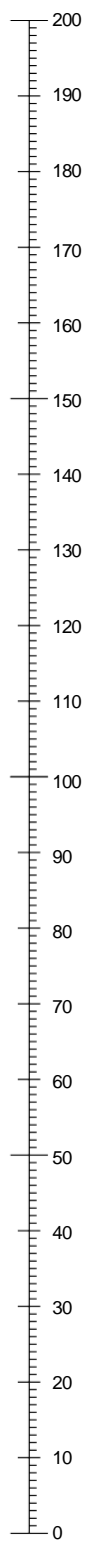



2.0mm Limited Contact Plate

Order Code	No. of Holes	Length mm	RRP
LCP-20-04	4	25	£35.70
LCP-20-05	5	31	£39.10
LCP-20-06	6	37	£42.40
LCP-20-07	7	43	£45.90
LCP-20-08	8	49	£49.20
LCP-20-09	9	55	£52.60
LCP-20-10	10	61	£56.00
LCP-20-11	11	67	£59.40
LCP-20-12	12	73	£62.80
LCP-20-13	13	79	£66.00
LCP-20-14	14	85	£69.30

Dimensions are 5.3mm X 1.5mm

End Hole is fixed round Hole

Single Tapered end for submuscular plate application

All Plates are made from Stainless Steel ISO 5832-1

2.4mm Limited Contact Plate

Order Code	No. of Holes	Length mm	RRP
LCP-24-04	4	38	£35.70
LCP-24-05	5	46	£39.10
LCP-24-06	6	54	£42.40
LCP-24-07	7	62	£45.90
LCP-24-08	8	70	£49.20
LCP-24-09	9	78	£52.60
LCP-24-10	10	86	£56.00
LCP-24-11	11	94	£59.40
LCP-24-12	12	102	£62.80
LCP-24-13	13	110	£67.00
LCP-24-14	14	118	£71.00
LCP-24-15	15	126	£74.00
LCP-24-16	16	134	£77.00

Dimensions are 7mm X 2mm + Plate Length/ No. of Slots.

These plates are used in the same manner as the DCP, but have grooves (undercuts) in the plate that allow for more uniform stiffness throughout the plate (reduced stiffness between the screw holes). These undercuts allow for easier bending of the plate between the screw holes when contouring. They also decrease the chance of plate failure because forces are more evenly distributed throughout the plate. In addition, they allow cells and blood supply to infiltrate the area more easily to aid in healing. Unlike the standard DCP screw holes, the screw holes in LC-DCPs are designed to compress in both directions.

By design, the screw holes have an oblique undercut for improved range of inclination. Lateral undercuts in the Plate profile allow for bone formation at the plate side of the periosteal surface.

All Plates are made from Stainless Steel ISO 5832-1

Limited Contact Plate 2.0mm

(Underside Shown)



LCP-20-14



LCP-20-14



LCP-20-13



LCP-20-12



LCP-20-11



LCP-20-10



LCP-20-09

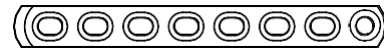

LCP-20-08

LCP-20-07

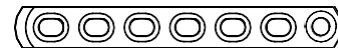

LCP-20-06



LCP-20-05

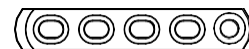

LCP-20-04

2.4mm Limited Contact Plate

LCP-24-04

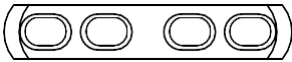

LCP-24-05

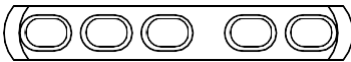

LCP-24-06



LCP-24-07



LCP-24-08

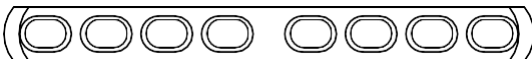

LCP-24-09



LCP-24-10



LCP-24-11

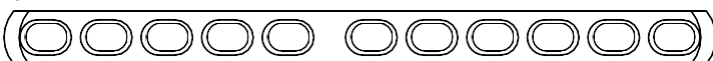

LCP-24-12

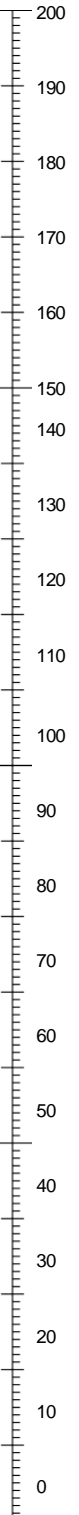



2.7mm Limited Contact Plate

Order Code	No. of Holes	Length mm	RRP
LCP-27-02	2	26	£32.30
LCP-27-03	3	35	£34.00
LCP-27-04	4	44	£35.70
LCP-27-05	5	53	£39.10
LCP-27-06	6	62	£42.40
LCP-27-07	7	71	£45.90
LCP-27-08	8	80	£49.20
LCP-27-09	9	89	£52.60
LCP-27-10	10	98	£56.00
LCP-27-11	11	107	£59.40
LCP-27-12	12	116	£62.80
LCP-27-13	13	125	£66.20
LCP-27-14	14	134	£69.60
LCP-27-15	15	143	£73.00
LCP-27-16	16	152	£76.40
LCP-27-18	18	161	£79.80

Dimensions are 7.5mm X 2.5mm + Plate Length/No. of Slots.

These plates are used in the same manner as the DCP, but have grooves (undercuts) in the plate that allow for more uniform stiffness throughout the plate (reduced stiffness between the screw holes). These undercuts allow for easier bending of the plate between the screw holes when contouring. In addition, they allow cells and blood supply to infiltrate the area more easily to aid in healing. Unlike the standard DCP screw holes, the screw holes in LC-DCPs are designed to compress in both directions.

By design, the screw holes have an oblique undercut for improved range of inclination. Lateral undercuts in the Plate profile allow for bone formation at the plate side of the periosteal surface.

All Plates are made from Stainless Steel ISO 5832-1



2.7mm Limited Contact Plate

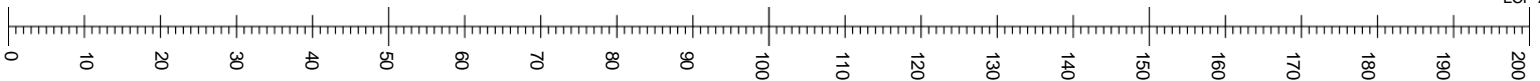
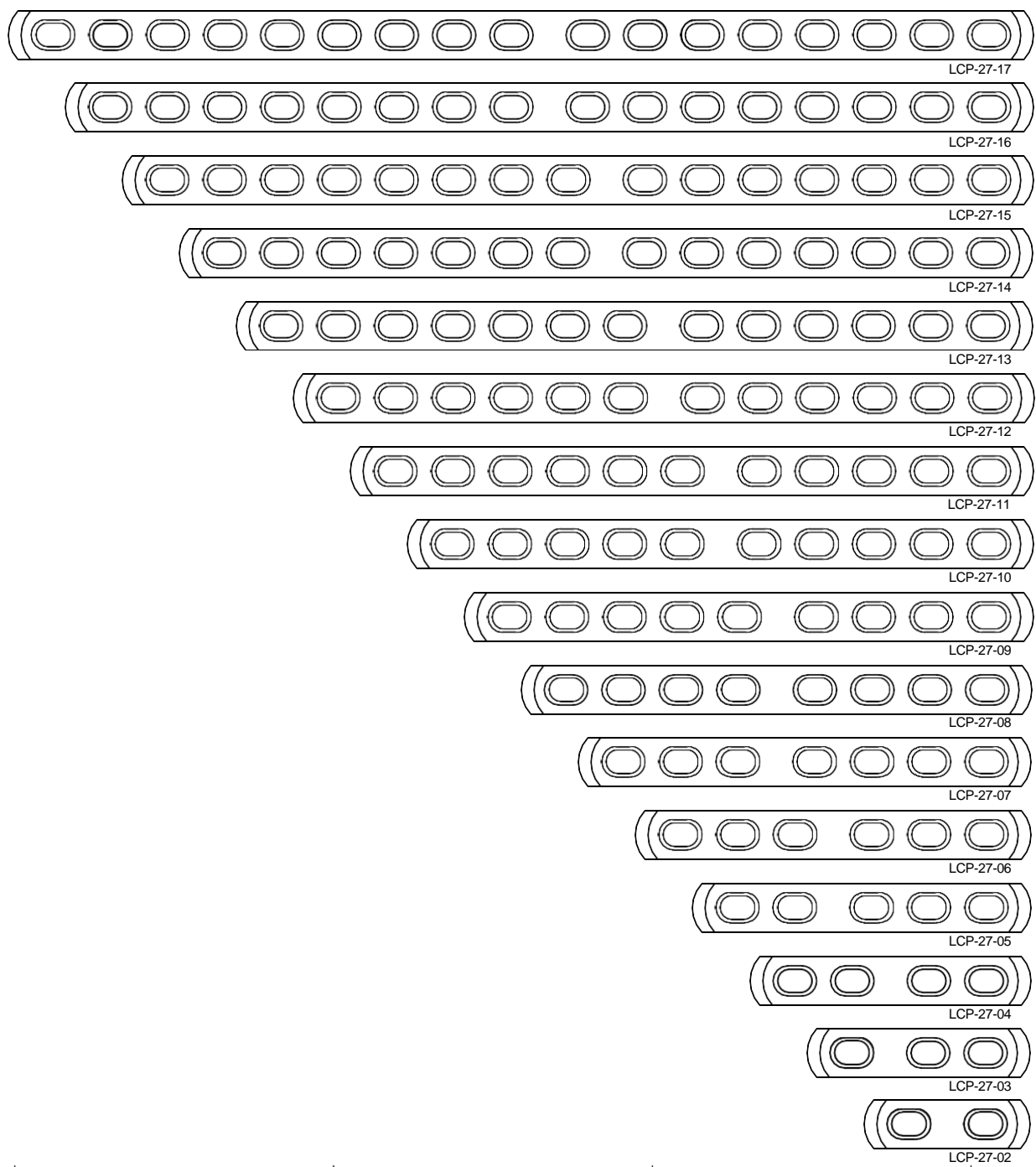



3.5mm Limited Contact Plate

Order Code	No. of Holes	Length mm	RRP
LCP-35-02	2	30	£28.90
LCP-35-03	3	43	£32.30
LCP-35-04	4	56	£35.70
LCP-35-05	5	69	£39.10
LCP-35-06	6	82	£42.40
LCP-35-07	7	95	£45.90
LCP-35-08	8	108	£49.20
LCP-35-09	9	121	£52.60
LCP-35-10	10	134	£56.00
LCP-35-11	11	147	£59.40
LCP-35-12	12	160	£61.10
LCP-35-13	13	173	£64.50
LCP-35-14	14	186	£67.90
LCP-35-15	15	199	£71.30
LCP-35-16	16	212	£74.70

11mm X 3.3mm Pre Contoured Profile + Plate Length/No. of Slots.

These plates are used in the same manner as the DCP, but have grooves (undercuts) in the plate that allow for more uniform stiffness throughout the plate (reduced stiffness between the screw holes). These undercuts allow for easier bending of the plate between the screw holes when contouring. In addition, they allow cells and blood supply to infiltrate the area more easily to aid in healing. Unlike the standard DCP screw holes, the screw holes in LC-DCPs are designed to compress in both directions.

By design, the screw holes have an oblique undercut for improved range of inclination. Lateral undercuts in the Plate profile allow for bone formation at the plate side of the periosteal surface.

All Plates are made from Stainless Steel ISO 5832-1

3.5mm Limited Contact Plate

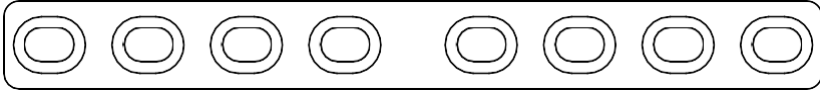

LCP-35-08

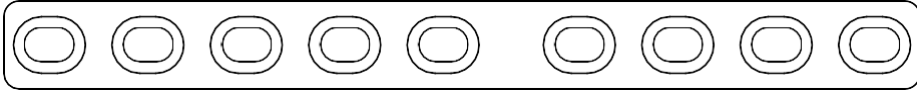

LCP-35-09

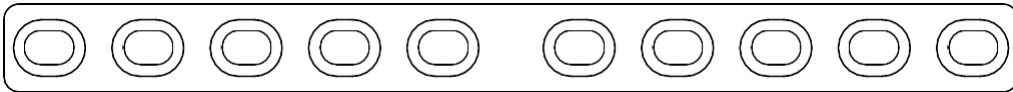

LCP-35-10

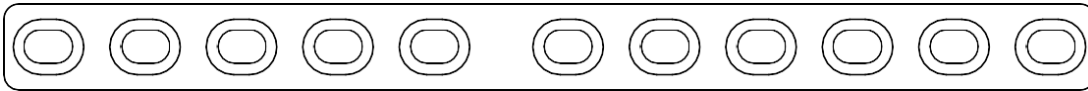

LCP-35-11

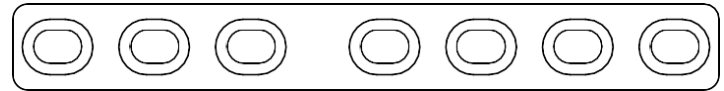

LCP-35-07

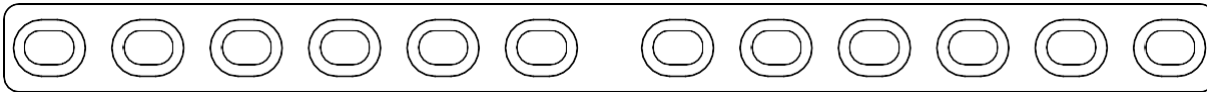

LCP-35-12

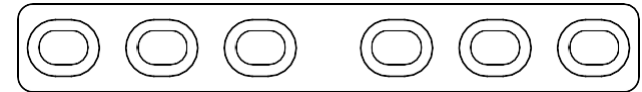

LCP-35-06

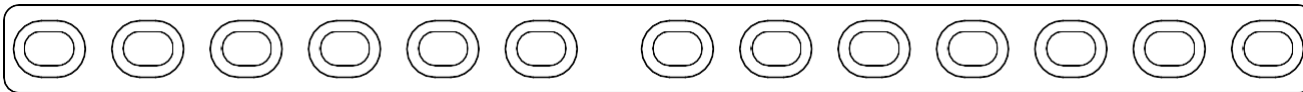

LCP-35-13

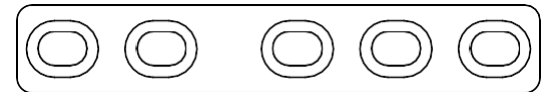

LCP-35-05

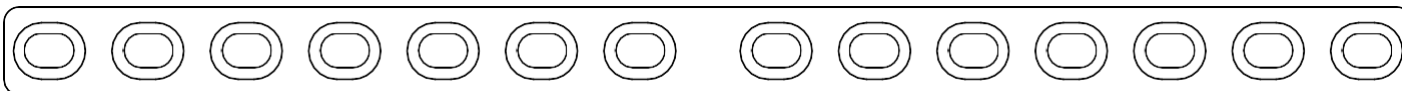

LCP-35-14

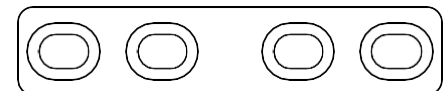

LCP-35-04

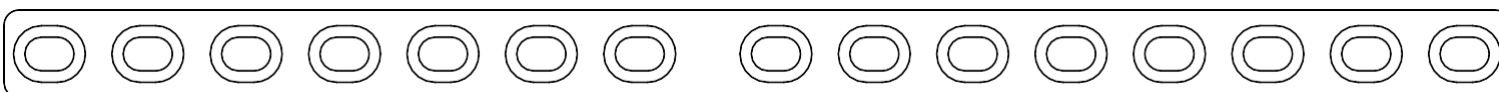

LCP-35-15

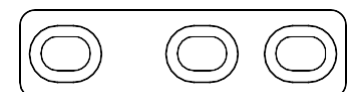

LCP-35-03

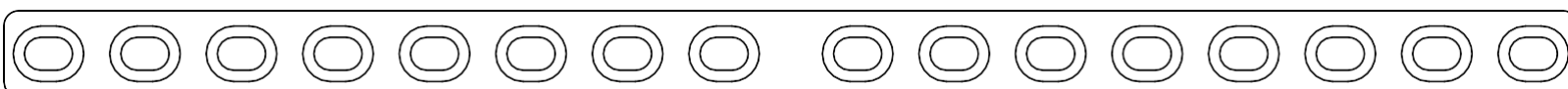

LCP-35-16

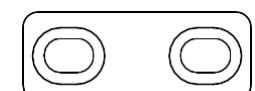

LCP-35-02





3.5mm Broad Limited Contact Plate

Order Code	No. of Holes	Length mm	RRP
LCB-35-04	4	56	£45.90
LCB-35-05	5	69	£49.20
LCB-35-06	6	82	£52.60
LCB-35-07	7	95	£56.00
LCB-35-08	8	108	£59.40
LCB-35-09	9	121	£62.80
LCB-35-10	10	134	£66.20
LCB-35-11	11	147	£69.60
LCB-35-12	12	160	£73.00
LCB-35-13	13	173	£76.40
LCB-35-14	14	186	£79.80
LCB-35-15	15	199	£83.20
LCB-35-16	16	212	£86.50

12mm X 4mm Pre Contoured Profile + Plate Length/No. of Slots.

These plates are used in the same manner as the DCP, but have grooves (undercuts) in the plate that allow for more uniform stiffness throughout the plate (reduced stiffness between the screw holes). These undercuts allow for easier bending of the plate between the screw holes when contouring. In addition, they allow cells and blood supply to infiltrate the area more easily to aid in healing. Unlike the standard DCP screw holes, the screw holes in LC-DCPs are designed to compress in both directions.

By design, the screw holes have an oblique undercut for improved range of inclination. Lateral undercuts in the Plate profile allow for bone formation at the plate side of the periosteal surface.

All Plates are made from Stainless Steel ISO 5832-1

3.5mm Broad Limited Contact Plate

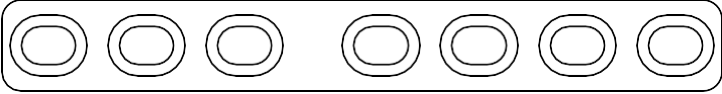

LCB-35-07

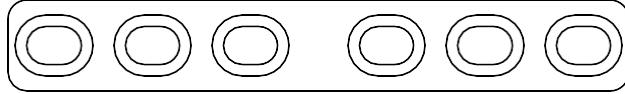

LCB-35-06

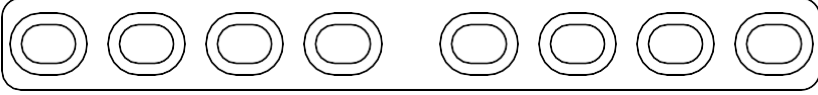

LCB-35-08

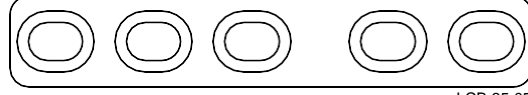

LCB-35-05

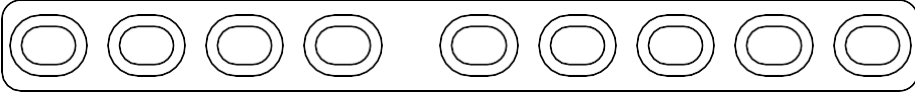

LCB-35-09

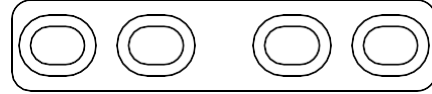

LCB-35-04

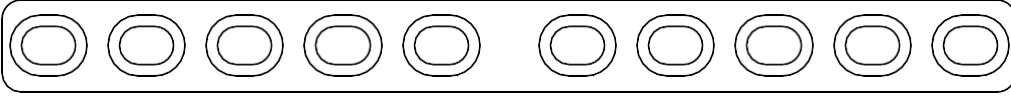

LCB-35-10

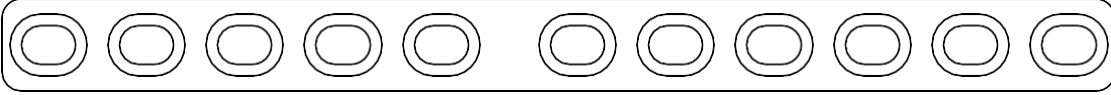

LCB-35-11

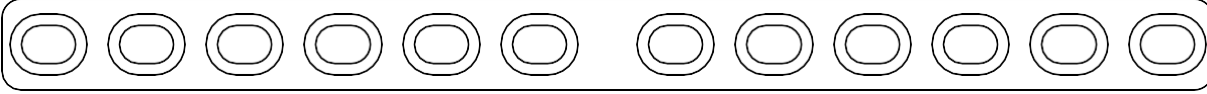

LCB-35-12

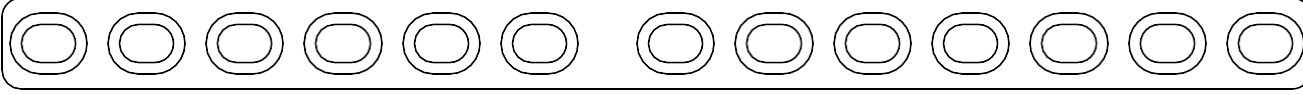

LCB-35-13

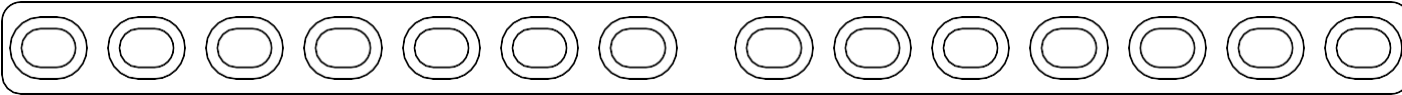

LCB-35-14

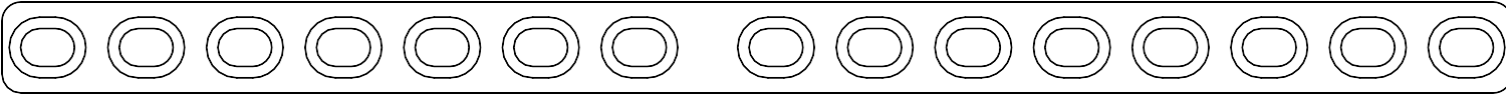

LCB-35-15

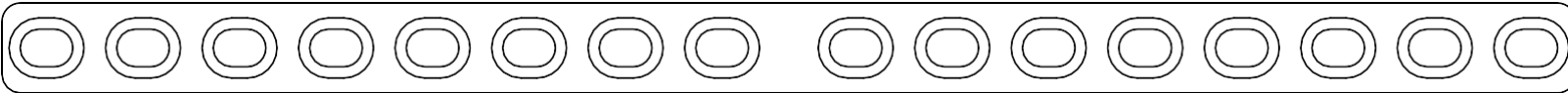

LCB-35-16

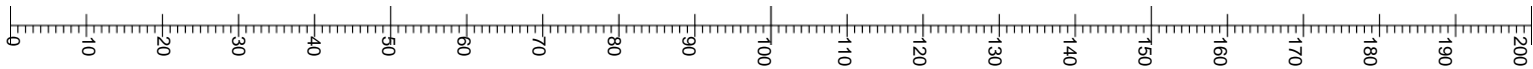



Supracondylar and Osteotomy (Distal Femur) Plates

Order Code	Length mm	RRP
SUP-20-50-R	50	£49.20
SUP-20-50-L	50	£49.20
SUP-20-120-R	120	£84.90
SUP-20-120-L	120	£84.90
SUP-24-62-R	62	£66.20
SUP-24-62-L	62	£66.20
SUP-27-69-L	69	£66.20
SUP-27-69-R	69	£66.20
SUP-35-135-NL	135	£106.90
SUP-35-135-NR	135	£106.90
SUP-35-135-BL	135	£127.30
SUP-35-135-BR	135	£127.30
SUP-35-173-BL	173	£127.30
SUP-35-173-BR	173	£127.30

N = Narrow B = Broad

Available in screw sizes 2.0mm to 3.5mm with various lengths to suit. Multiple compression slots and pre-contoured for convenience. If further contouring is required it is recommended to use a bending template as an aid.

Plates are not manufactured from cast or forged material.

All Plates are made from Stainless Steel ISO 5832-1.

Supracondylar Osteotomy Plates

Order Code	Length mm	RRP
SCO-20-50-R	50	£66.20
SCO-20-50-L	50	£66.20
SCO-24-55-R	55	£66.20
SCO-24-55-L	55	£66.20
SCO-27-61-R	61	£66.20
SCO-27-61-L	61	£66.20
SCO-35-86-R	86	£100.10
SCO-35-86-L	86	£100.10
SCO-35B-88-R	88	£127.30
SCO-35B-88-L	88	£127.30

Intertarsal Arthrodesis Plate

Order Code	Length mm	RRP
IAP-20-27	59	£84.90
IAP-27-35	86	£84.90

Designed to fuse the bones of the calcaneoquartal or tarsometatarsal joints in a functional position due to injury of the plantar tarsal fibrocartilage.

All Plates are made from Stainless Steel ISO 5832-1

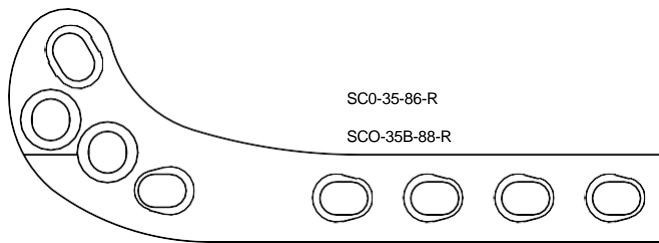

Supracondylar and Osteotomy Plates

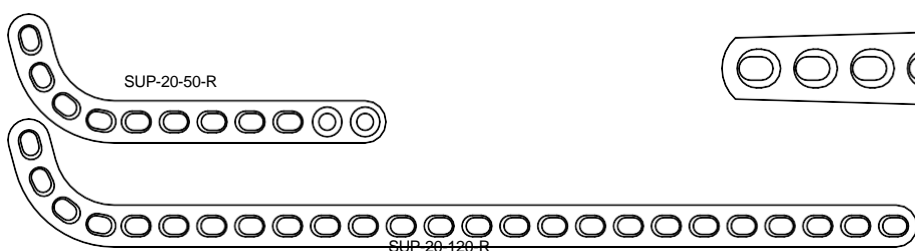
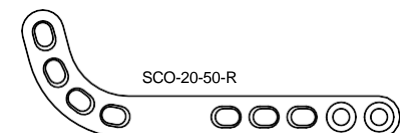
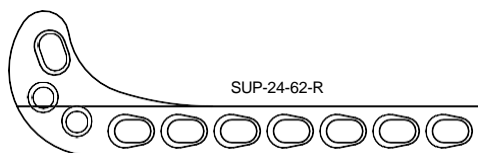
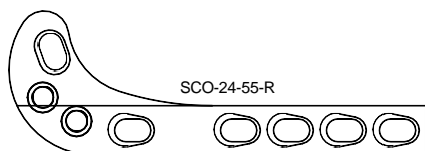
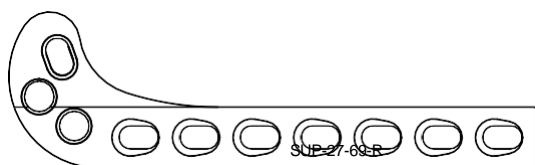
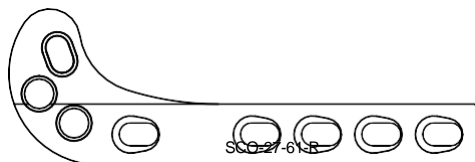
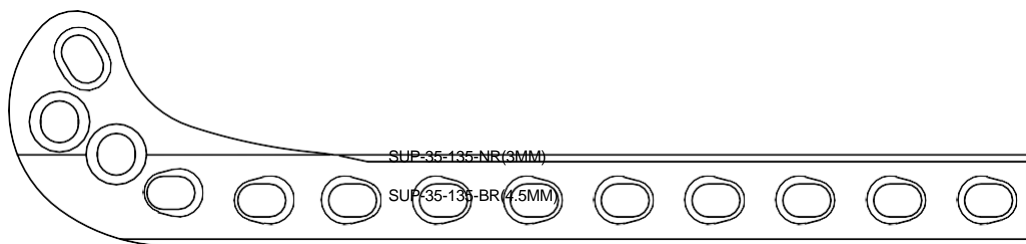
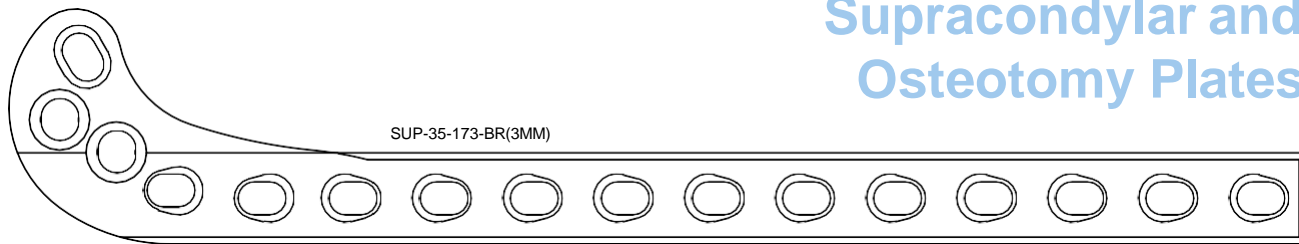

Intertarsal Arthrodesis Plate

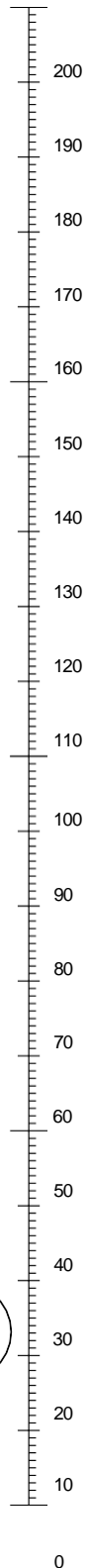
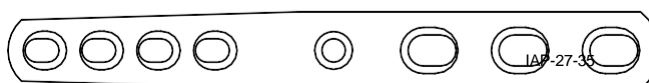
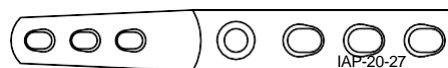

*Plates are shown right hand



2.0mm Round Hole Plate

Order Code	No. of Holes	Lengths mm	RRP
RHP-20-02	2	10	£10.20
RHP-20-03	3	15	£11.10
RHP-20-04	4	20	£11.90
RHP-20-05	5	25	£13.60
RHP-20-06	6	30	£15.30
RHP-20-07	7	35	£17.00
RHP-20-08	8	40	£18.70
RHP-20-02-XL	2	13	£10.20
RHP-20-03-XL	3	18	£11.10
RHP-20-04-XL	4	23	£11.90
RHP-20-05-XL	5	28	£13.60
RHP-20-06-XL	6	33	£15.30
RHP-20-07-XL	7	38	£17.00
RHP-20-08-XL	8	43	£18.70

2.0mm Plate is 5mm wide, 1.5mm thick. Use with 2.0mm Cortical Screws/Sherman Screws.

Non Compression Plate. An economical range of Bone Plates pre-contoured for secure fixation.

All Plates are made from Stainless Steel ISO 5832-1

2.7mm Round Hole Plate

Order Code	No. of Holes	Lengths mm	RRP
RHP-27-02	2	12	£10.20
RHP-27-03	3	18	£11.10
RHP-27-04	4	24	£11.90
RHP-27-05	5	30	£13.60
RHP-27-06	6	36	£15.30
RHP-27-07	7	42	£17.00
RHP-27-08	8	48	£18.70
RHP-27-02-XL	2	15	£10.20
RHP-27-03-XL	3	21	£11.10
RHP-27-04-XL	4	27	£11.90
RHP-27-05-XL	5	33	£13.60
RHP-27-06-XL	6	39	£15.30
RHP-27-07-XL	7	45	£17.00
RHP-27-08-XL	8	51	£18.70

2.7mm Plate is 6mm wide, 2mm thick. Use with 2.7mm Cortical Screws/Sherman Screws.

Non Compression Plate. An economical range of Bone Plates pre-contoured for secure fixation.

All Plates are made from Stainless Steel ISO 5832-1

3.5mm Round Hole Plate

Order Code	No. of Holes	Lengths mm	RRP
RHP-35-02	2	22	£11.90
RHP-35-03	3	34	£12.80
RHP-35-04	4	46	£13.60
RHP-35-05	5	58	£15.30
RHP-35-06	6	70	£17.00
RHP-35-07	7	82	£18.70
RHP-35-08	8	94	£20.40
RHP-35-09	9	106	£22.10
RHP-35-10	10	118	£23.80
RHP-35-04-XL	4	52	£13.60
RHP-35-05-XL	5	64	£15.30
RHP-35-06-XL	6	76	£17.00
RHP-35-07-XL	7	88	£18.70
RHP-35-08-XL	8	100	£20.40
RHP-35-09-XL	9	118	£22.10
RHP-35-10-XL	10	130	£23.80

3.5mm Plate are 10.2mm wide, 3.2mm thick Pre contoured Profile. Use with 3.5mm Cortical Screws or 9/64" Sherman Screws.

Non Compression Plate. An economical range of Bone Plates pre-contoured for secure fixation.

All Plates are made from Stainless Steel ISO 5832-1

3.5mm Round Hole Plate

RHP-35-10-XL



RHP-35-10

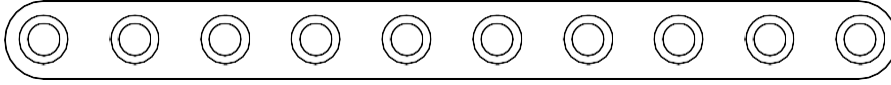

RHP-35-09-XL

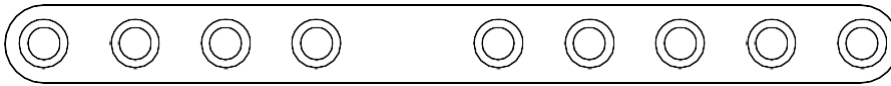

RHP-35-09

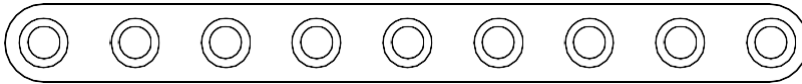

RHP-35-08-XL



RHP-35-08

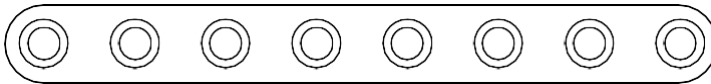

RHP-35-07-XL

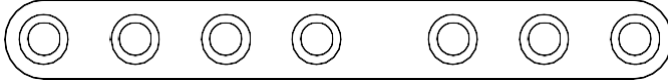

RHP-35-07

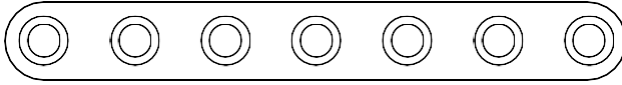

RHP-35-06-XL

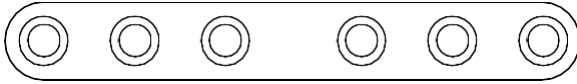

RHP-35-06

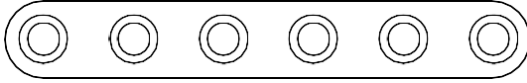

RHP-35-05-XL

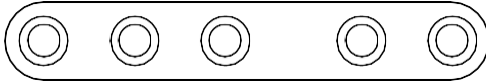

RHP-35-05

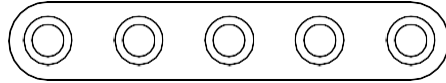

RHP-35-04-XL



RHP-35-04

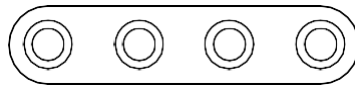

RHP-35-03

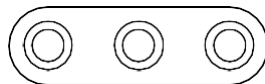

RHP-35-02



RHP-20-02-XL

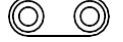

RHP-20-03



RHP-20-03-XL

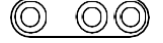

RHP-20-04



RHP-20-04-XL

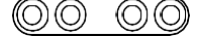

RHP-20-05



RHP-20-05-XL



RHP-20-06



RHP-20-06-XL



RHP-20-07



RHP-20-07-XL



RHP-20-08



RHP-20-08-XL



RHP-27-02-XL



RHP-27-03-XL



RHP-27-04



RHP-27-04-XL

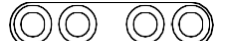

RHP-27-05



RHP-27-05-XL



RHP-27-06



RHP-27-06-XL

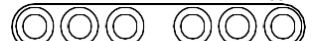

RHP-27-07



RHP-27-07-XL

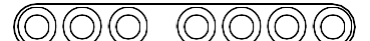

RHP-27-08



RHP-27-08-XL

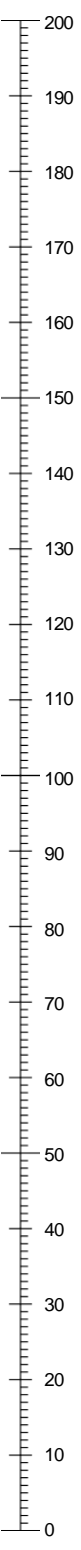

2.0mm Round Hole Plate

2.7mm Round Hole Plate



2.7mm Heavy Duty Round Hole Plate

Order Code	No. of Holes	Length mm	RRP
HDR-27-07	7	44	£20.40
HDR-27-08	8	50	£22.10
HDR-27-09	9	56	£23.80
HDR-27-10	10	62	£25.50
HDR-27-11	11	68	£27.20
HDR-27-12	12	74	£28.90
HDR-27-07-XL	7	50	£20.40
HDR-27-08-XL	8	56	£22.10
HDR-27-09-XL	9	62	£23.80
HDR-27-10-XL	10	68	£25.50
HDR-27-11-XL	11	74	£27.20
HDR-27-12-XL	12	80	£28.90

Plates are 8mm wide, 2.0mm thick Pre contoured Profile. Use with 2.7mm Cortical Screws /Sherman Screws.

Non Compression Plate. An economical range of Bone Plates pre-contoured for secure fixation.

All Plates are made from Stainless Steel ISO 5832-1

3.5mm Heavy Duty Round Hole Plate

Order Code	No. of Holes	Length mm	RRP
HDR-35-08	8	104	£20.40
HDR-35-09	9	117	£22.10
HDR-35-10	10	130	£23.80
HDR-35-11	11	143	£25.50
HDR-35-12	12	156	£27.20
HDR-35-13	13	169	£28.90
HDR-35-14	14	182	£30.60
HDR-35-15	15	195	£32.30

Heavy Duty Plates are 11.5mm wide, 4mm thick Pre contoured Profile. Use with 3.5mm Cortical Screws/9/64" Sherman Screws.

Non Compression Plate. An economical range of Bone Plates pre-contoured for secure fixation.

All Plates are made from Stainless Steel ISO 5832-1

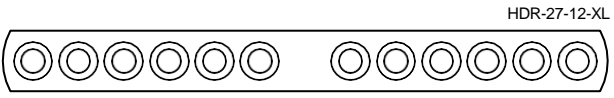

HDR-27-12-XL

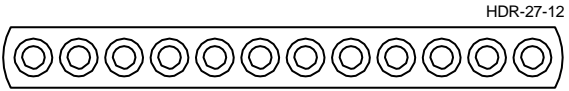

HDR-27-12

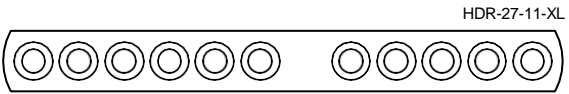

HDR-27-11-XL



HDR-27-11

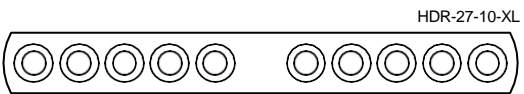

HDR-27-10-XL

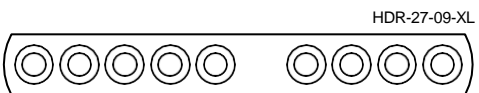

HDR-27-09-XL

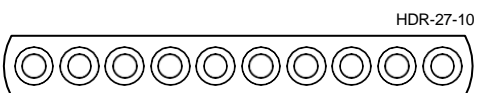

HDR-27-10

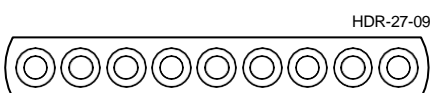

HDR-27-09

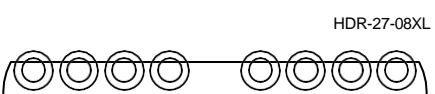

HDR-27-08XL

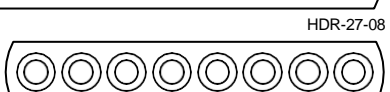

HDR-27-08

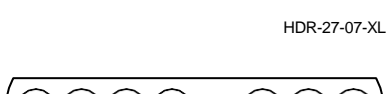

HDR-27-07-XL

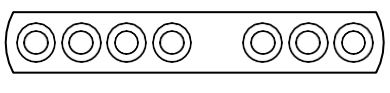

HDR-27-07

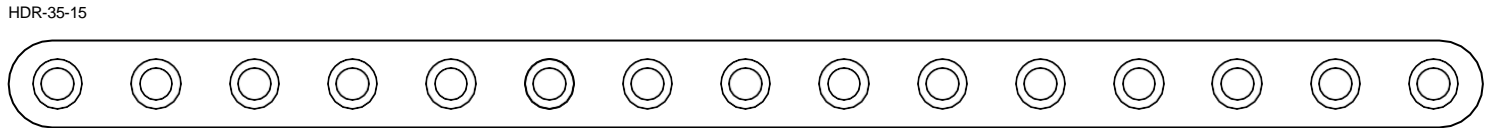

HDR-35-15

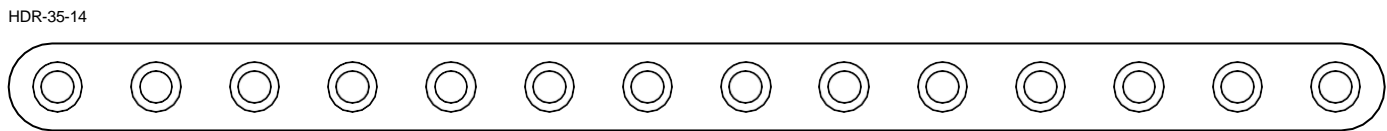

HDR-35-14

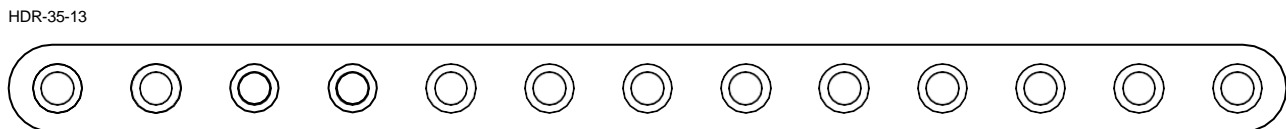

HDR-35-13

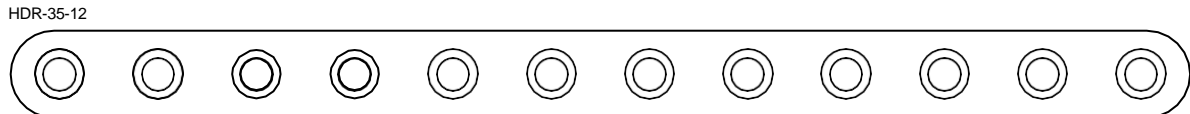

HDR-35-12

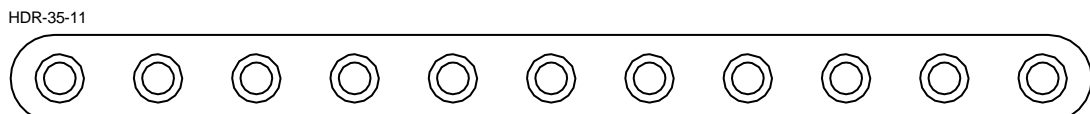

HDR-35-11

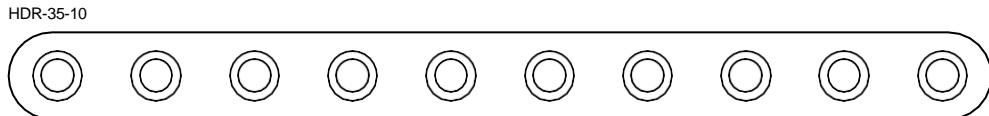

HDR-35-10

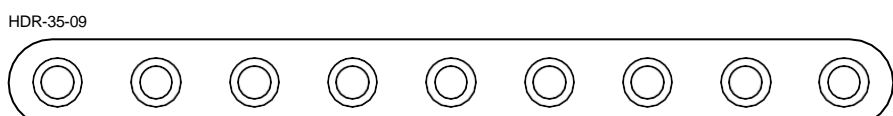

HDR-35-09

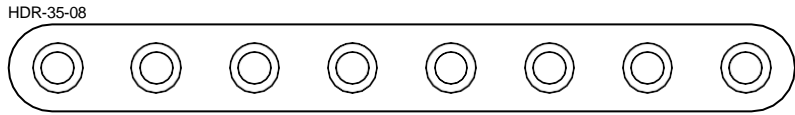

HDR-35-08

2.7mm Heavy Duty Round Hole Plate

3.5mm Heavy Duty Round Hole Plate

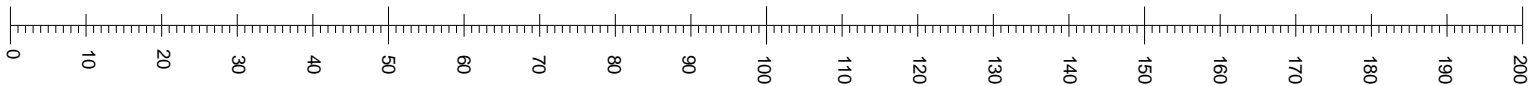



TPO EQ

Order Code	No. of Holes	Length mm	RRP
TPO35-SM	4	36	£38.60
TPO35-SML30	4	36	£41.90
TPO35-SMR30	4	36	£41.90
TPO35-LG	4	48	£44.10
TPO35-LGL30	4	48	£47.50
TPO35-LGR30	4	48	£47.50

Available flat or pre-bent at 30 degrees

TPLO Delta 'Style' Plates

Order Code	Ø Screw mm	RRP
DEL-20-L	2.0	£37.50
DEL-20-R	2.0	£37.50
DEL-24-L	2.4	£39.10
DEL-24-R	2.4	£39.10
DEL-27-L	2.7	£39.10
DEL-27-R	2.7	£39.10
DEL-27-LB	2.7	£42.40
DEL-27-RB	2.7	£42.40
DEL-35-L	3.5	£43.70
DEL-35-R	3.5	£43.70
DEL-35-BR	3.5	£49.20
DEL-35-BL	3.5	£49.20

Tibial Plateau Levelling Osteotomy

Pre Contoured TPLO Triangular shaped Plates

Available in six sizes (2.0mm, 2.4mm, 2.7mm, 2.7mm Broad, 3.5mm and 3.5mm Broad) and both Left and Right Hands.

Stainless Steel ISO 5832-1

For Evolox® selection of Delta plates please see page 160

TPO EQ

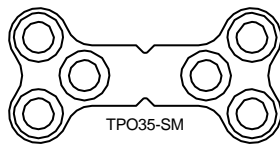

TPO35-SM
TPO35-SML30
TPO35-SMR30

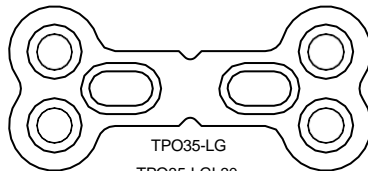

TPO35-LG
TPO35-LGL30
TPO35-LGR30

TPLO Delta 'Style' Plates

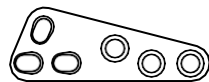

DEL-20-L

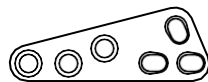

DEL-20-R

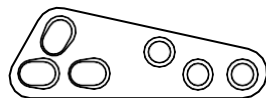

DEL-24-L

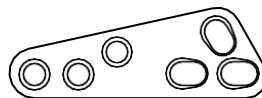

DEL-24-R

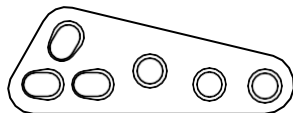

DEL-27-L

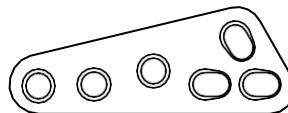

DEL-27-R

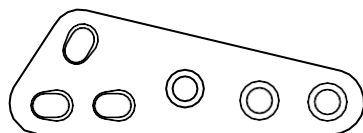

DEL-27-LB

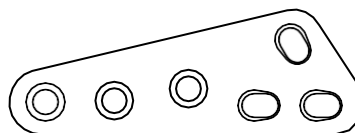

DEL-27-RB

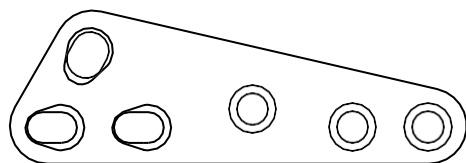

DEL-35-L

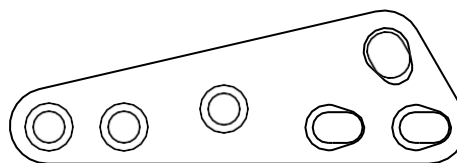

DEL-35-R

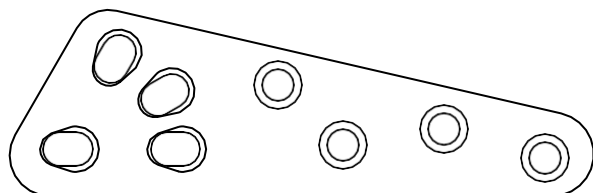

DEL-35-BL

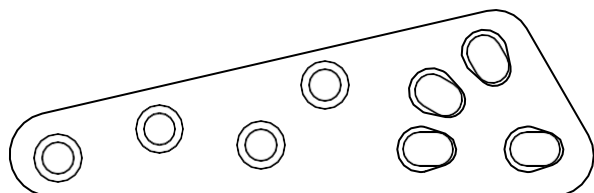

DEL-35-BR

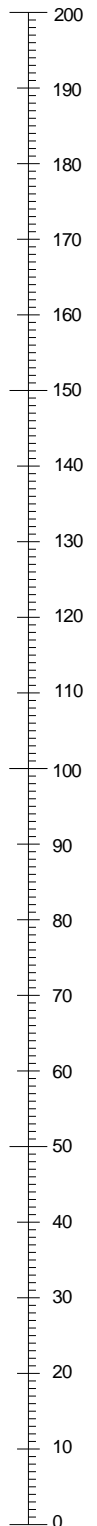



TPLO (Slocum style)

Order Code	No. of Holes	Length mm	RRP
SLO-20-L	6	26.5	£40.80
SLO-20-R	6	26.5	£40.80
SLO-24-L	6	35	£40.80
SLO-24-R	6	35	£40.80
SLO-27-L	6	41	£40.80
SLO-27-R	6	41	£40.80
SLO-35-L	6	64	£49.20
SLO-35-R	6	64	£49.20
SLO-35-PCL	6	64	£59.40
SLO-35-PCR	6	64	£59.40

Tibial Plateau Levelling Osteotomy

Available in six sizes (2.0mm, 2.4mm, 2.7mm, 3.5mm, 3.5mm Pre-contoured and 3.5mm broad) and both Left and Right Hands.

Pre-Contoured and a notched underside to aid final contouring.

Not from Cast or Forging

All Plates are made from Stainless Steel ISO 5832-1

TPLO Compression Plates

Order Code	No. of Holes	Length mm	RRP
TPL-15-15-31	4 + 3	31	£27.20
TPL-20-20-26	3 + 3	26	£23.80
TPL-24-24-34	3 + 3	34	£28.00
TPL-24-24-41	4 + 3	41	£28.00
TPL-24-24-41G	3 + 3	41	£28.00
TPL-27-27-39	3 + 3	39	£28.00
TPL-27-35-39	3 + 3	39	£28.00
TPL-27-35-45	3 + 3	45	£31.40
TPL-35-35-55	3 + 3	55	£39.90
TPL-35-35-57	3 + 3	57	£39.90
TPL-35-35-62	3 + 3	62	£39.90
TPL-35-35-78	4 + 3	78	£39.90
TPL-35-35-80	4 + 3	80	£42.40
TPL-35-45-80	4 + 3	80	£42.40
TPL-35-45/65-80	4 + 3	80	£46.80
TPL-45/65-90-30	4 + 3	90	£76.40
TPL-45/65-90-45	4 + 3	90	£76.40

Tibial Plateau Levelling Osteotomy

This technique strives to alter the naturally-occurring downward slope (angle) of the tibial plateau. Because of this slope, the femur, which rests upon the tibial plateau, has a tendency to push the tibia forward; normally the CCL acts to restrain this thrust but cannot adequately stabilize the stifle joint when injured or torn. This bio-mechanical fixation procedure is designed to eliminate tibial thrust using standard screws and Plates

All size screws from 2.0mm to 6.5mm are covered within the range. Various lengths and pre-contouring enhance a popular choice for TPLO surgery.

Stainless Steel ISO 5832-1

TPLO Pre Contoured Compression Plates

Order Code	No. of Holes	Length mm	RRP
TPC-35-35-55L	3+3	55	£44.10
TPC-35-35-55R	3+3	55	£44.10
TPC-35-35-57L	3+3	57	£44.10
TPC-35-35-57R	3+3	57	£44.10
TPC-35-35-80L	4+3	80	£48.30
TPC-35-35-80R	4+3	80	£48.30

TPLO (Slocum style)

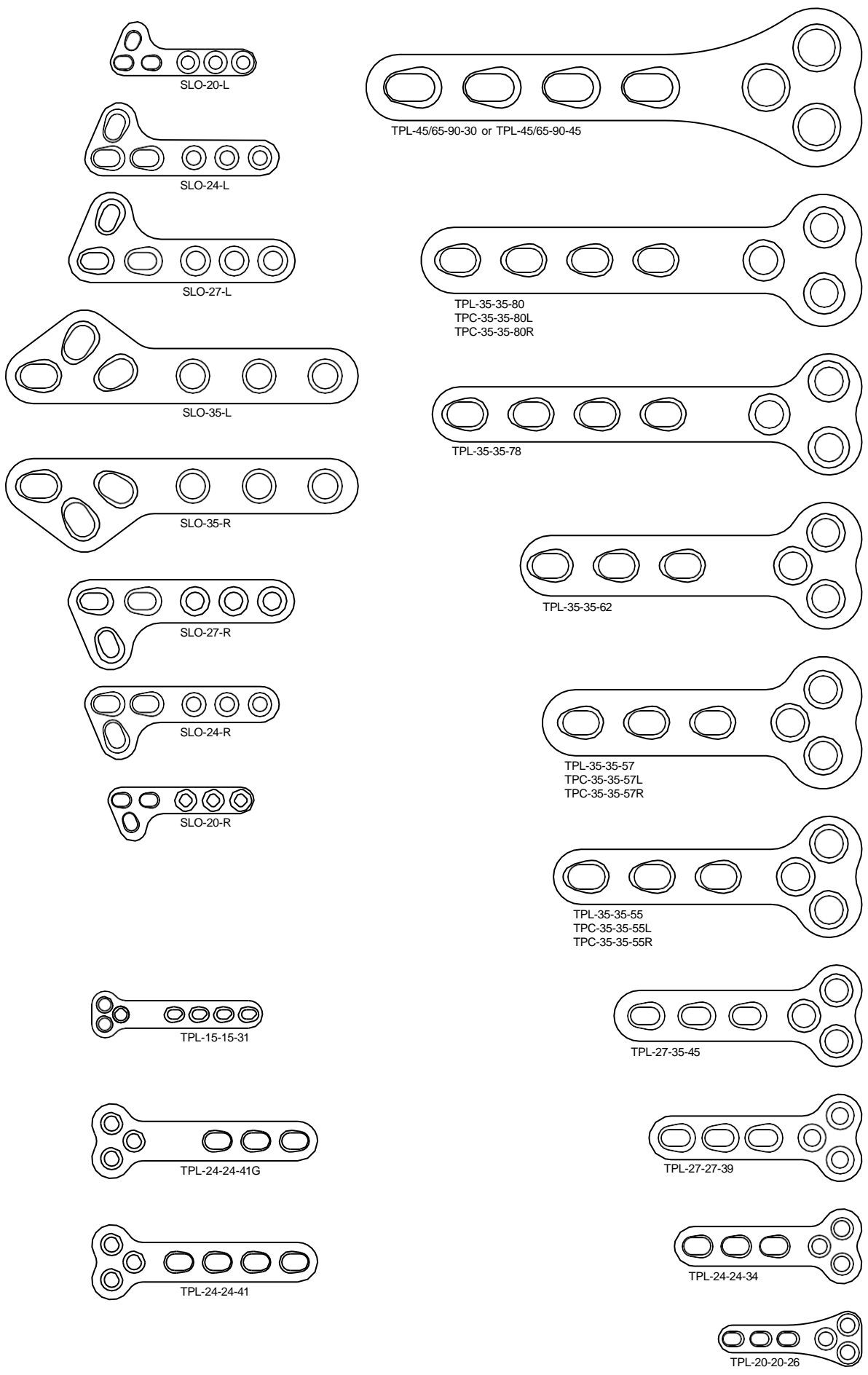

TPLO Compression Plates

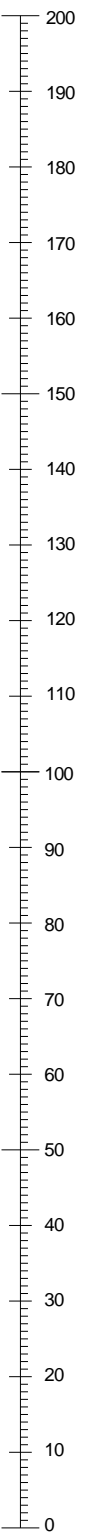



Titanium Plates

There has been a strong demand for Titanium Plates and we are introducing a select range of common product ranges anodised in Blue for easy reference.

nb Please ensure only Titanium Screws are used with these Plates.

We only use Implantable grade Titanium which conforms to ISO 5832-3 ASTM F139 and implants are completely manufactured in the UK to strict Human Implant Standards.

- Titanium is light weight, around 45% of stainless 316LVM making it much lighter on larger plates.
- It is extremely biocompatible and has a low rejection rate by the body.
- MRI Compatible, (non-ferromagnetic, which means it can be safely examined).
- Higher Fatigue Life.
- Excellent corrosion resistance.
- Titanium anodising also produces anti-galling properties.
- Osseointegration.

Titanium TPLO Compression Plates

Order Code	Ø Screw	No. of Holes	Length mm	RRP
Ti-TPL-24-24-34	2.4/2.4mm	3 + 3	34	£40.80
Ti-TPL-27-27-39	2.7/2.7mm	3 + 3	39	£40.80
Ti-TPL-27-35-39	2.7/3.5mm	3 + 3	39	£46.00
Ti-TPL-35-35-55	3.5/3.5mm	3 + 3	55	£59.80
Ti-TPL-35-35-57	3.5/3.5mm Broad	3 + 3	57	£62.30
Ti-TPL-35-35-62	3.5/3.5mm Long	3 + 3	62	£62.30
Ti-TPL-35-35-78	3.5/3.5mm X Long	4 + 3	78	£63.80
Ti-TPL-35-35-80	3.5/3.5mm X Long Broad	4 + 3	80	£63.80
Ti-TPL-35-45-80	3.5/4.5mm X Long Broad	4 + 3	80	£63.80

Titanium TPLO Delta Plates

Order Code	Ø Screw	Length mm	RRP
Ti-DEL-24-L	Up to 2.4mm	34	£45.90
Ti-DEL-24-R	Up to 2.4mm	34	£45.90
Ti-DEL-27-L	Up to 2.7mm	38	£45.90
Ti-DEL-27-R	Up to 2.7mm	38	£45.90
Ti-DEL-35-L	Up to 3.5mm	60	£50.90
Ti-DEL-35-R	Up to 3.5mm	60	£50.90
Ti-DEL-35-RB	Up to 3.5mm	76	£59.40
Ti-DEL-35-LB	Up to 3.5mm	76	£59.40

For Profile images

See page 118 - 2.4mm Locking Plates

See Page 106 - TPLO Compression Plates

See page 108 - TPLO Delta Plates





Titanium Pancarpal and Pantarsal Plates

Codes L=Left R=Right T=Tarsal Slot XS=Short

Order Code	Ø Screw	Length mm	RRP
TI-PAD-20-27	2.0/2.7mm	34	£157.50
TI-PAD-20-27L	2.0/2.7mm	34	£157.50
TI-PAD-27-35	2.7/3.5mm	38	£157.50
TI-PAD-27-35-PB-L	2.7/3.5mm	38	£200.00
TI-PAD-27-35L	2.7/3.5mm	60	£157.50
TI-PAD-27-35-135L	2.7/3.5mm	60	£90.00
TI-PAD-27-35-135R	2.7/3.5mm	76	£90.00

Order Code	Ø Screw	Degrees	RRP
Ti-PAN-20-27-135-TL	2.0/2.7	135° With Tarsal Slot Left	£173.30
Ti-PAN-20-27-135-TR	2.0/2.7	135° With Tarsal Slot Right	£173.30
Ti-PAN-27-35-135-TL	2.7/3.5	135° With Tarsal Slot Left	£189.00
Ti-PAN-27-35-135-TL XS	2.7/3.5	135° With Tarsal Slot. Short Left	£173.30
Ti-PAN-27-35-135-TR	2.7/3.5	135° With Tarsal Slot Right	£189.00
Ti-PAN-27-35-135-TR-XS	2.7/3.5	135° With Tarsal Slot. Short Right	£173.30
Ti-PAN-27-35-135L	2.7/3.5	135° Left	£94.50
Ti-PAN-27-35-135R	2.7/3.5	135° Right	£173.30

** We can make a large selection of titanium plates not listed here. If you have a special request or want a stainless-steel plate manufactured in Titanium please contact us for more information.

Titanium Pancarpal and Pantarsal Plates

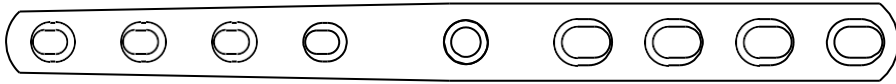

Ti-PAD-27-35L



Ti-PAD-27-35



Ti-PAD-20-27

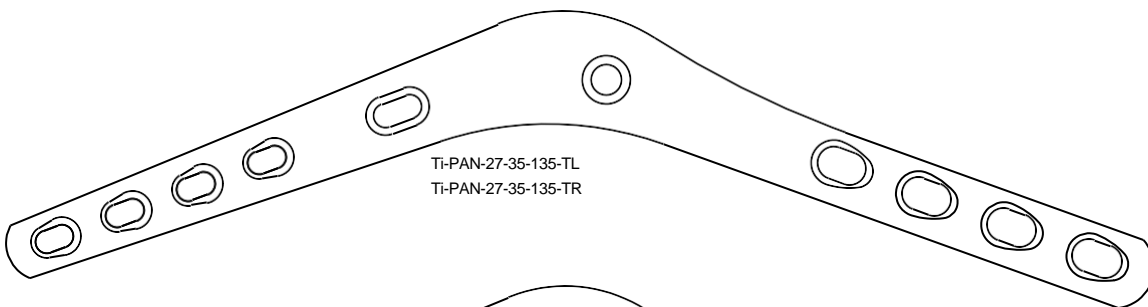

Ti-PAN-27-35-135-TL
Ti-PAN-27-35-135-TR

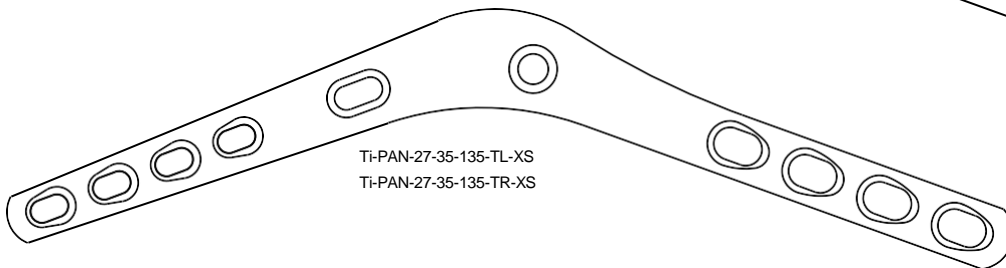

Ti-PAN-27-35-135-TL-XS
Ti-PAN-27-35-135-TR-XS

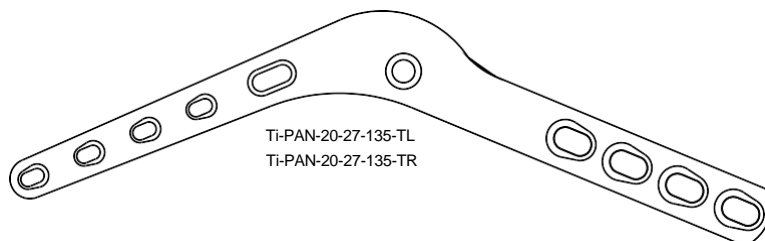

Ti-PAN-20-27-135-TL
Ti-PAN-20-27-135-TR

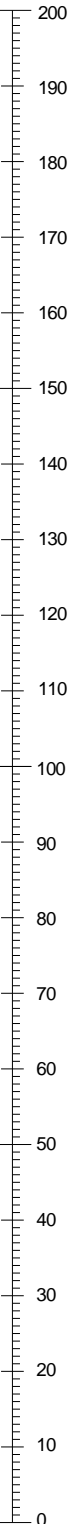

Locking Plates (Mono-axial)





	Page
2.0mm Locking Plate	115
2.0mm YY plates	115
Circular Cuttable Locking Plate	115
2mm Locking T-Plates	115
Mono-Axial Locking Antebrachial Plates	116
2.4 Locking Plate	118
2.7 Locking Plate	120
3.5mm Locking Plate	122
<hr/>	
1.5mm Locking Drill Guide	124
2.0mm Locking Drill Guide	124
2.4mm Locking Drill Guide	124
2.7mm Locking Drill Guide	124
3.5mm Locking Drill Guide	124
<hr/>	
2.0mm Locking Plug	126
2.7mm Locking Plug	126
3.5mm Locking Plug	126
Cannulated Locking Plugs	126

2.0mm Locking Plate

There is a need for 2.0mm Locking Screws and Plates for very small patients so we have launched two cuttable plates that will prove to be a versatile addition to your inventory.

Order Code	Description	RRP
LPL-CUT-20-100-18	2.0mm Cuttable Locking plate 18 Holes 100mm Long	£105.00
LPL-CUT-20-100-20	2.0mm Cuttable Locking plate 20 Holes 100mm Long	£105.00

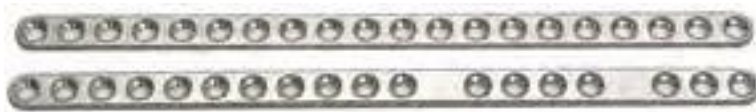

scale 1:1

2.0mm YY Plates

Newly added these 2.0mm YY plates offer additional stability at both ends of the fracture. The plate flexibility ensures easy contourability and allows a good plate/bone interface.

Order Code	Description	RRP
LPL-YY-20-12	2.0mm 12 Hole Locking Double ended Y plate	£126.00
LPL-YY-20-13	2.0mm 13 Hole Locking Double ended Y plate	£126.00
LPL-YY-20-14	2.0mm 14 Hole Locking Double ended Y plate	£126.00

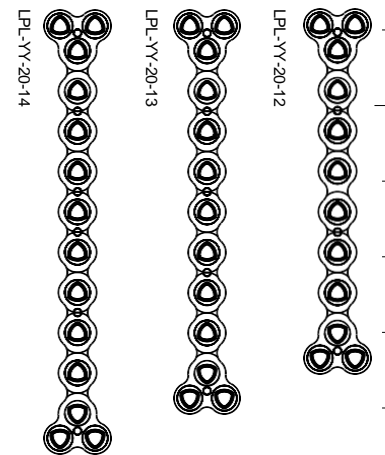

Circular Cuttable Locking Plate

The smallest ring in our range this cuttable monoaxial plate is useful for a variety of maxillofacial and pelvic trauma injuries.

Order Code	Description	RRP
LPL-RP-20-36-24	2.0mm Locking Maxillofacial Ring Plate 24 Hole 36mm Diameter	£147.00

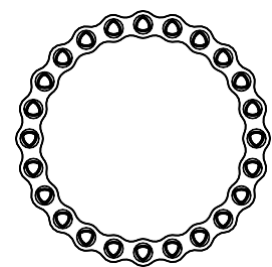

2.0mm Locking T-Plates

A selection of useful Locking T-plates for smaller patients

Order Code	Head Locking screw size	Shaft Locking screw size	Shaft DCP screw size	Length	RRP
LPL-T-20-20-35	2.0	2.0	2.0	35	£50.00
LPL-T-20-20-42	2.0	2.0	2.0	42	£57.80
LPL-T-20-20-49	2.0	2.0	2.0	49	£63.00
LPL-T-20-20-65	2.0	2.0	2.0	65	£68.30

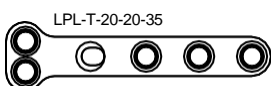

LPL-T-20-20-35

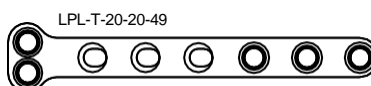

LPL-T-20-20-49

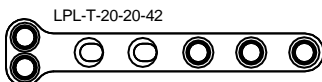

LPL-T-20-20-42

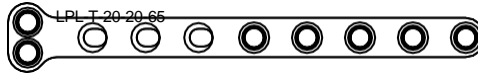

LPL-T-20-20-65

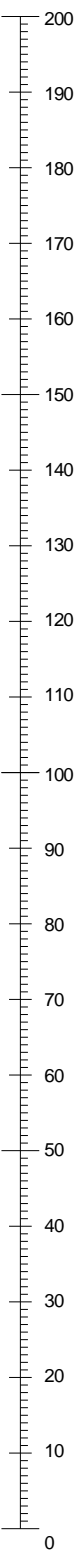



Mono-Axial Locking Antebrachial Plates

Order Code	Description	RRP
LPL-BRA-20-6L	2.0mm Locking Antebrachial Plates x 39.5mm	£42.00
LPL-BRA-20-6	2.0mm Locking Antebrachial Plates x 34.5mm	£39.90
LPL-BRA-24-6L	2.4mm Locking Antebrachial Plates x 59mm	£47.30
LPL-BRA-24-6	2.4mm Locking Antebrachial Plates x 52mm	£45.20
LPL-BRA-27-6L	2.7mm Locking Antebrachial Plates x 66mm	£49.40
LPL-BRA-27-6	2.7mm Locking Antebrachial Plates x 58mm	£47.30
LPL-BRA-35-6L	3.5mm Locking Antebrachial Plates x 86mm	£51.50
LPL-BRA-35-6	3.5mm Locking Antebrachial Plates x 76mm	£49.40

Mono-Axial Trauma/Antebrachial Plates:

Based on 7 & 8 hole Mono-Axial locking plates, this useful new design is intended for mid-distal antebrachial fractures suited to a straight plate. They are indicated for application to the radius to treat fractures with the following features:

- obliquity
- bone deficits
- comminution
- poor blood supply (e.g. toy breeds)

Features:

Extra plate strength - no empty Screw holes over your fracture line.

Versatile lengths - 1 or 2 hole spacing to suit the fracture.

Less extensor restriction - very useful around the distal antebrachium.

Increased simplicity - increased plate strength reduces the need for orthogonal plating of the ulna.

Extensive size range - 2.0mm, 2.4mm, 2.7mm & 3.5mm locking.

Cost effective - benefits of locking fixation without the extra cost of Poly-Axial Screw holes where not needed.

Conical shaped threaded holes - suit locking Screws or cortical Screws allowing bone to conform to the plate if needed.

Reduced inventory - no need for locking plugs.

Thanks to: Patrick Currivan MVB GPCertSAS CertAVP(GSAS) MRCVS

2.0mm Mono-Axial Locking Compression Locking Plate (MCL-20-XXX)

You can use 2.0mm ISO Regular Locking Screws, 2.0mm Cortical Screws or a mixture of both.

Designed to also take 2.2mm Cancellous Screws.

Order Code	Description	RRP
MCL-20-05	2.0mm Locking and Compression Plates 5 Hole X 30mm	£36.80
MCL-20-06	2.0mm Locking and Compression Plates 6 Hole X 35mm	£39.90
MCL-20-07	2.0mm Locking and Compression Plates 7 Hole X 40mm	£43.10
MCL-20-08	2.0mm Locking and Compression Plates 8 Hole X 45mm	£47.30
MCL-20-09	2.0mm Locking and Compression Plates 9 Hole X 50mm	£50.40
MCL-20-10	2.0mm Locking and Compression Plates 10 Hole X 55mm	£52.50
MCL-20-11	2.0mm Locking and Compression Plates 11 Hole X 60mm	£54.60
MCL-20-12	2.0mm Locking and Compression Plates 12 Hole X 65mm	£56.70
MCL-20-13	2.0mm Locking and Compression Plates 13 Hole X 70mm	£58.80
MCL-20-14	2.0mm Locking and Compression Plates 14 Hole X 75mm	£60.90

Antebrachial Plates

LPL-BRA-20-6L



LPL-BRA-20-6

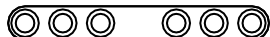

LPL-BRA-24-6L

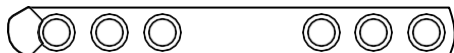

LPL-BRA-24-6

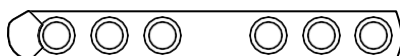

LPL-BRA-27-6L

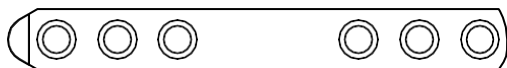

LPL-BRA-27-6

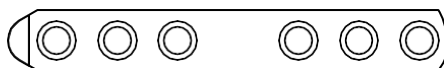

LPL-BRA-35-6L



LPL-BRA-35-6

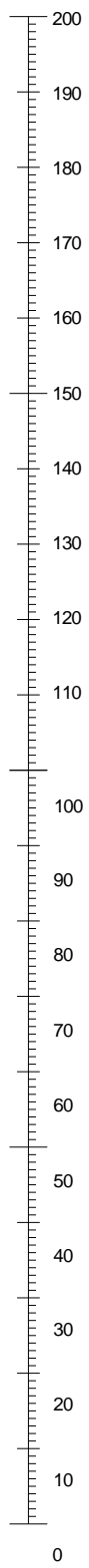

MCL-20-05



MCL-20-06



MCL-20-07



MCL-20-08

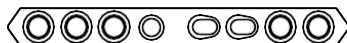

MCL-20-09



MCL-20-10



MCL-20-11



MCL-20-12



MCL-20-13



MCL-20-14





Veterinary Supplies

Conical shaped threaded holes to suit either twin start Locking Screws or standard plating techniques using approved ISO Cortical Bone Screws. This dual combination hole is integral to the plates design not to pull the Locking Screw through the plate and offer a rigid reversible dual application solution to fixation.

The limited contact design on the underside of the plate offer the added advantage of reducing bending stress risers and vascular trauma.

All Plates are made from Stainless Steel ISO 5832-1



2.4mm Locking Plate

Order Code	Description	No. of Holes	RRP
LPL-24-04	2.4mm Stacked Locking Plate 31mm Long	4	£37.40
LPL-24-05	2.4mm Stacked Locking Plate 38mm Long	5	£39.90
LPL-24-06	2.4mm Stacked Locking Plate 45mm Long	6	£42.40
LPL-24-07	2.4mm Stacked Locking Plate 52mm Long	7	£45.00
LPL-24-08	2.4mm Stacked Locking Plate 59mm Long	8	£47.50
LPL-24-09	2.4mm Stacked Locking Plate 66mm Long	9	£50.10
LPL-24-10	2.4mm Stacked Locking Plate 73mm Long	10	£52.60
LPL-24-11	2.4mm Stacked Locking Plate 80mm Long	11	£55.20
LPL-24-12	2.4mm Stacked Locking Plate 87mm Long	12	£57.70
LPL-24-13	2.4mm Stacked Locking Plate 94mm Long	13	£60.30
LPL-24-14	2.4mm Stacked Locking Plate 101mm Long	14	£62.80
LPL-24-15	2.4mm Stacked Locking Plate 108mm Long	15	£65.30
LPL-24-16	2.4mm Stacked Locking Plate 115mm Long	16	£67.90
LPL-24-17	2.4mm Stacked Locking Plate 122mm Long	17	£71.30
LPL-24-18	2.4mm Stacked Locking Plate 129mm Long	18	£74.70

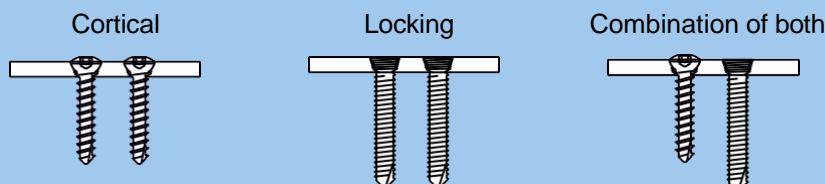

2.4 Locking Plate

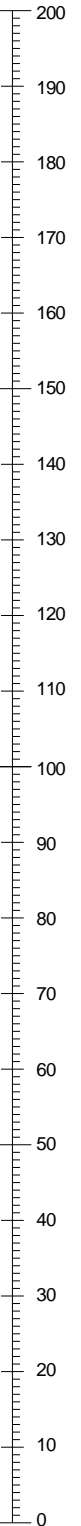
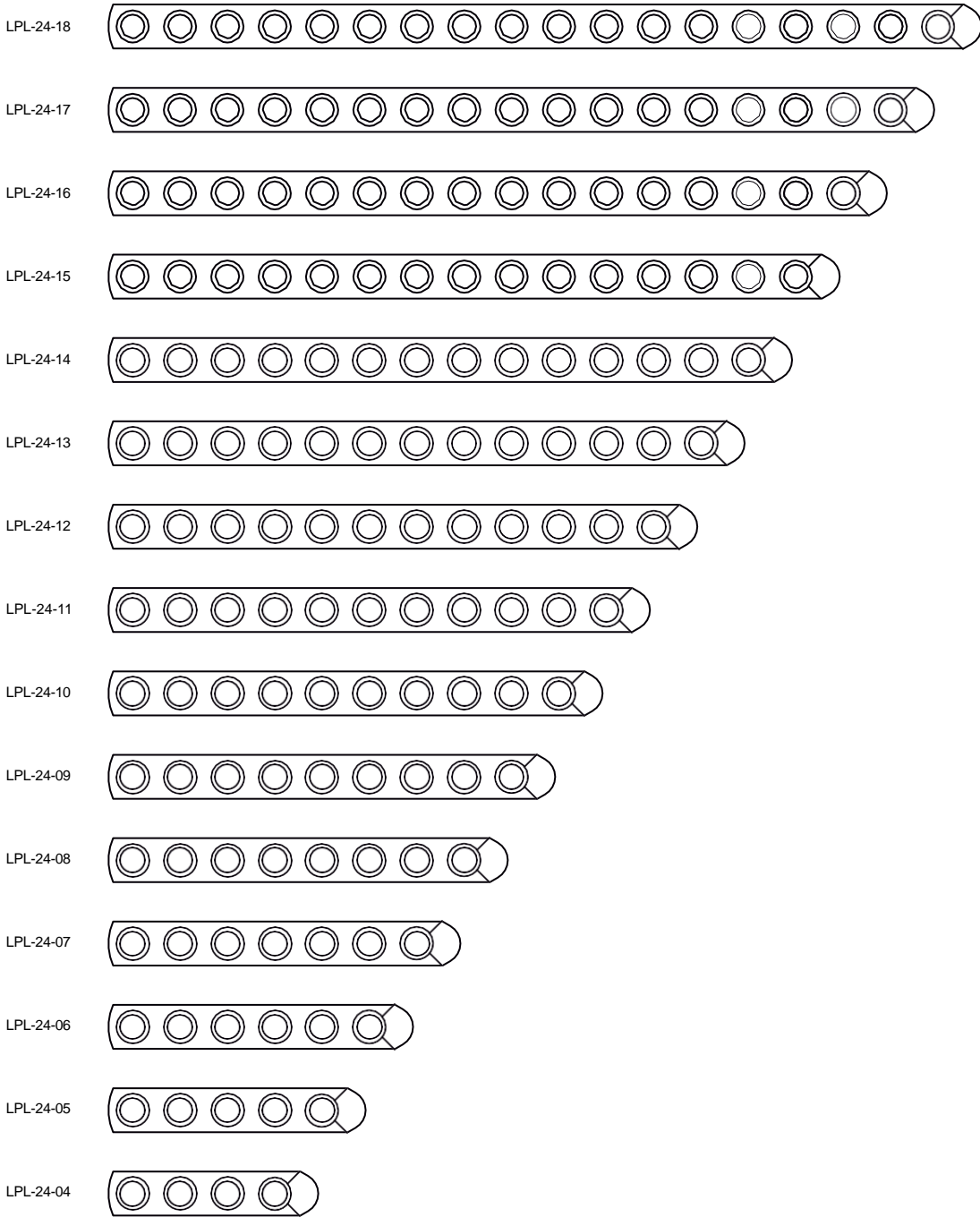



2.7mm Locking Plate

Order Code	Description	No. of Holes	RRP
LPL-27-04	2.7mm Stacked Locking Hole Plate 34mm long	4	£37.40
LPL-27-05	2.7mm Stacked Locking Hole Plate 42mm long	5	£39.90
LPL-27-06	2.7mm Stacked Locking Hole Plate 50mm long	6	£42.40
LPL-27-07	2.7mm Stacked Locking Hole Plate 58mm long	7	£45.00
LPL-27-08	2.7mm Stacked Locking Hole Plate 66mm long	8	£47.50
LPL-27-09	2.7mm Stacked Locking Hole Plate 74mm long	9	£50.10
LPL-27-10	2.7mm Stacked Locking Hole Plate 82mm long	10	£52.60
LPL-27-11	2.7mm Stacked Locking Hole Plate 90mm long	11	£55.20
LPL-27-12	2.7mm Stacked Locking Hole Plate 98mm long	12	£57.70
LPL-27-13	2.7mm Stacked Locking Hole Plate 106mm long	13	£60.30
LPL-27-14	2.7mm Stacked Locking Hole Plate 114mm long	14	£62.80
LPL-27-15	2.7mm Stacked Locking Hole Plate 122mm long	15	£65.30
LPL-27-16	2.7mm Stacked Locking Hole Plate 130mm long	16	£67.90
LPL-27-17	2.7mm Stacked Locking Hole Plate 138mm long	17	£71.30
LPL-27-18	2.7mm Stacked Locking Hole Plate 146mm long	18	£74.70

2.7 Locking Plate

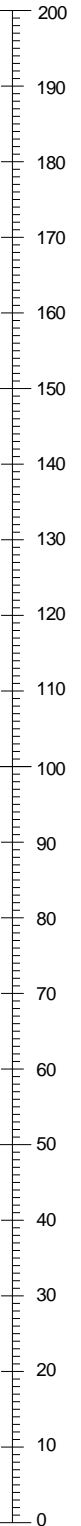
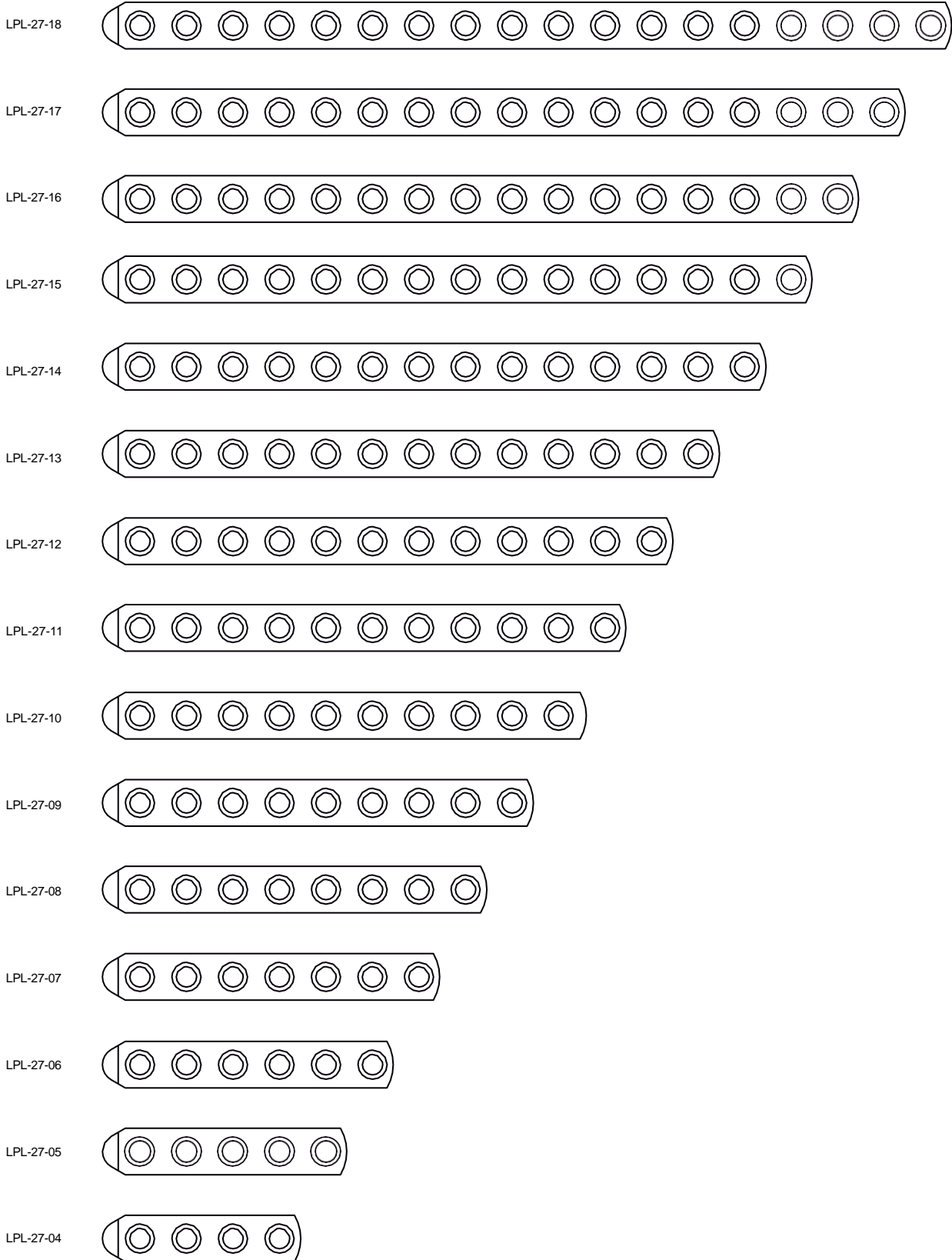

3.5mm Locking Plate

Order Code	Description	No. of Holes	RRP
LPL-35-04	3.5mm Stacked Locking Hole Plate 46mm long	4	£37.40
LPL-35-05	3.5mm Stacked Locking Hole Plate 56mm long	5	£39.90
LPL-35-06	3.5mm Stacked Locking Hole Plate 66mm long	6	£42.40
LPL-35-07	3.5mm Stacked Locking Hole Plate 76mm long	7	£45.00
LPL-35-08	3.5mm Stacked Locking Hole Plate 86mm long	8	£47.50
LPL-35-09	3.5mm Stacked Locking Hole Plate 96mm long	9	£50.10
LPL-35-10	3.5mm Stacked Locking Hole Plate 106mm long	10	£52.60
LPL-35-11	3.5mm Stacked Locking Hole Plate 116mm long	11	£55.20
LPL-35-12	3.5mm Stacked Locking Hole Plate 126mm long	12	£57.70
LPL-35-13	3.5mm Stacked Locking Hole Plate 136mm long	13	£60.30
LPL-35-14	3.5mm Stacked Locking Hole Plate 146mm long	14	£62.80
LPL-35-15	3.5mm Stacked Locking Hole Plate 156mm long	15	£65.30
LPL-35-16	3.5mm Stacked Locking Hole Plate 166mm long	16	£67.90
LPL-35-17	3.5mm Stacked Locking Hole Plate 176mm long	17	£71.30
LPL-35-18	3.5mm Stacked Locking Hole Plate 186mm long	18	£74.70





LPL-35-18



LPL-35-17



LPL-35-16



LPL-35-15



LPL-35-14



LPL-35-13



LPL-35-12

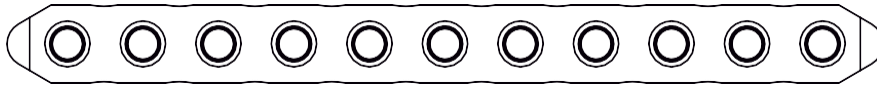

LPL-35-11

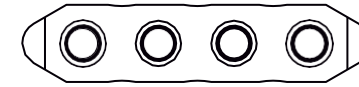

LPL-35-04



LPL-35-05

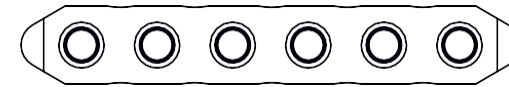

LPL-35-06



LPL-35-07

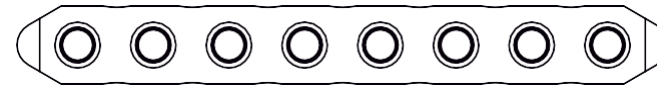

LPL-35-08

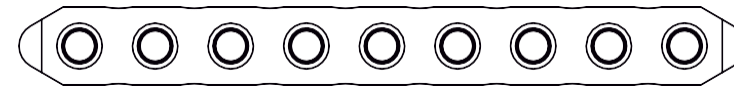

LPL-35-09

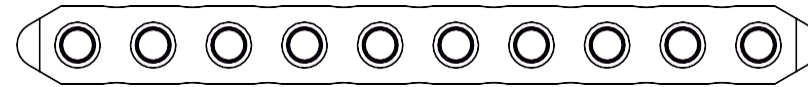

LPL-35-10

3.5mm Locking Plate

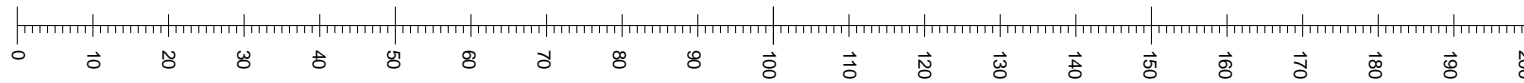



Locking Drill Guides

These can be used on all our mono-axial and poly-axial plates. We recommend keeping the angulation around 10° off centre, however a good rule of thumb is if the drill guide locks in the plate then the screw will also locate.

1.5mm Locking Drill Guide

Order Code	Length	RRP
LOC-1520-DGS*	23	£42.00

*For Hybrid 1520 screws



2.0mm Locking Drill Guide

Order Code	Length	RRP
LOC-20-DGS	23	£42.00
LOC-2024-DGS*	25	£42.00

*For Hybrid 2024 screws



2.4mm Locking Drill Guide

Order Code	Length	RRP
LOC-24-DGS	30	£42.00

2.7mm Locking Drill Guide

Order Code	Length	RRP
LOC-27-DGS	35	£42.00

3.5mm Locking Drill Guide

Order Code	Length	RRP
LOC-35-DGS	45	£42.00

1.5mm Locking Drill Guide

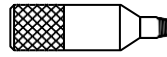

LOC-15-DGS

2.0mm Locking Drill Guide

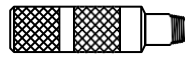

LOC-20-DGS

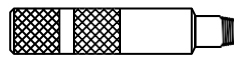

LOC-2024-DGS

2.4mm Locking Drill Guide

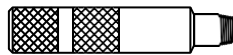

LOC-24-DGS

2.7mm Locking Drill Guide



LOC-27-DGS

3.5mm Locking Drill Guide

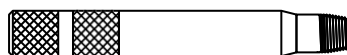

LOC-35-DGS

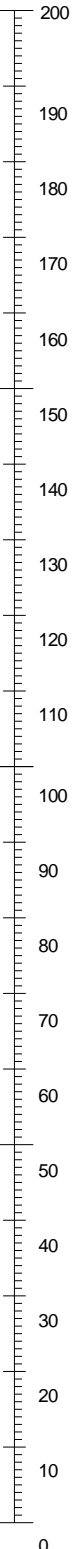



2.0mm Locking Plug

Order Code	Fits Plate	Head	RRP
LOC-20-PTD	2.0mm	Torx	£8.00



LOC-20-PTD

2.7mm Locking Plug

Order Code	Fits Plate	Head	RRP
LOC-2724-P	2.4/2.7mm	Hex	£8.00
LOC-2724-P-TD	2.4/2.7mm	Torx	£8.00



LOC-2724-P

3.5mm Locking Plug

Order Code	Fits Plate	Head	RRP
LOC-35-P	3.5mm	Hex	£8.00
LOC-35-P-TD	3.5mm	Torx	£8.00



LOC-35-P

Cannulated Locking Plugs

The Cannulated plugs are particularly useful as a way of holding the plates in situ whilst the other holes are drilled and filled. Reduces the need for bone holding forceps which can sometimes be hard to locate without interfering with the surgeon's working area.

Code	Description	Fits Plate	Drive	RRP
LOC-20-P-TDC	2.0mm Locking Plug. Cannulated 1.1mm (use 1.0mm guide wire)	2.0	Torx T6	£10.00
LOC-2724-P-TDC	2.7/2.4mm Locking Plug. Cannulated 1.6mm (use 1.4mm guide wire)	2.4/2.7	Torx T8	£10.00
LOC-35-P-TDC	3.5mm Locking Plug. Cannulated 1.6mm (use 1.4mm guide wire)	3.5	Torx T15	£10.00

Manufacturing Facilities in the UK

We are proud of our complete manufacturing facilities in the UK

We would be more than happy to arrange a guided tour of the facilities to see how we manufacturer your implants and prove they are never 'bought in' or 'reprocessed' from afar.

- CAD/CAM
- Electropolishing
- Laser Marking
- CNC Milling, CNC Multi Axis Turning & Threading
- Vibratory Finishing including Diamond, Porceline and Ultrasonic
- Packaging Solutions

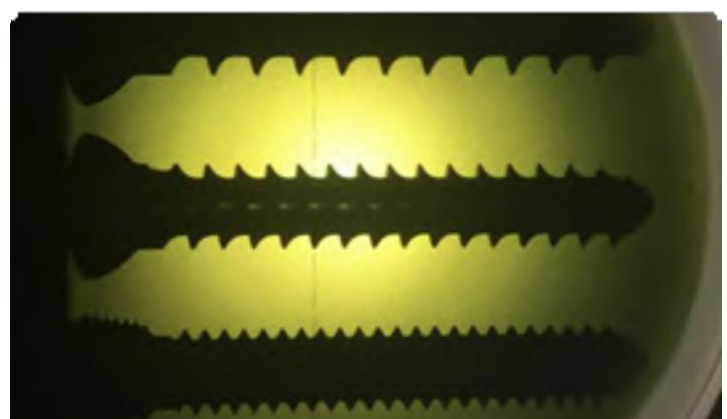
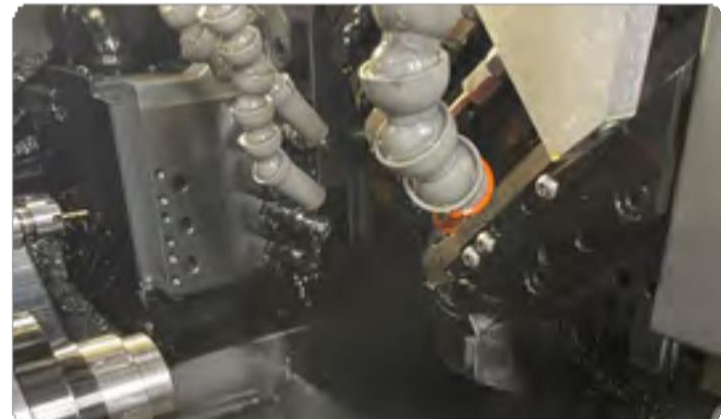
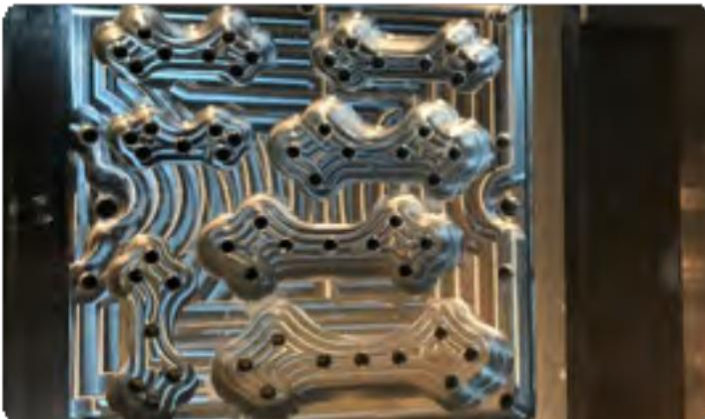
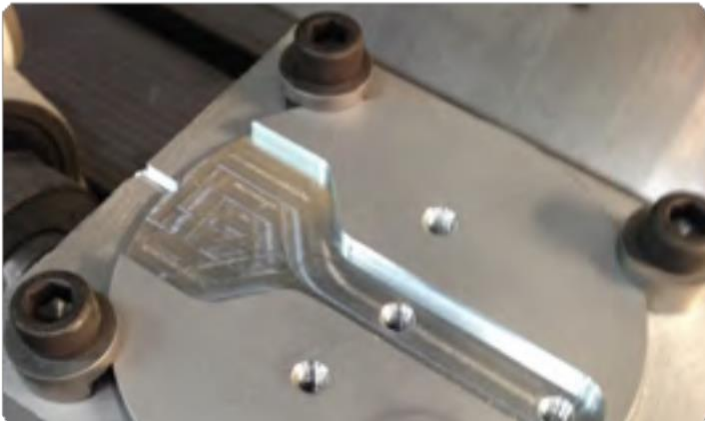

Evolox[®] Locking System

Poly-Axial Locking Systems

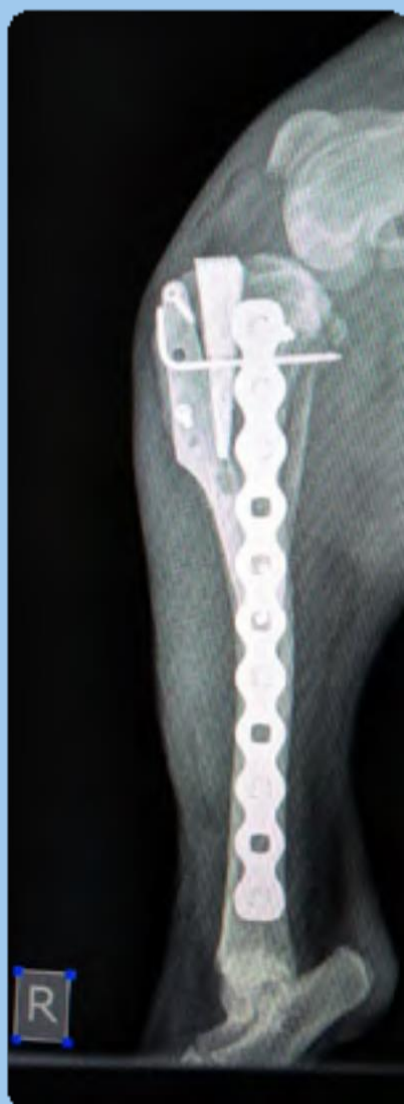
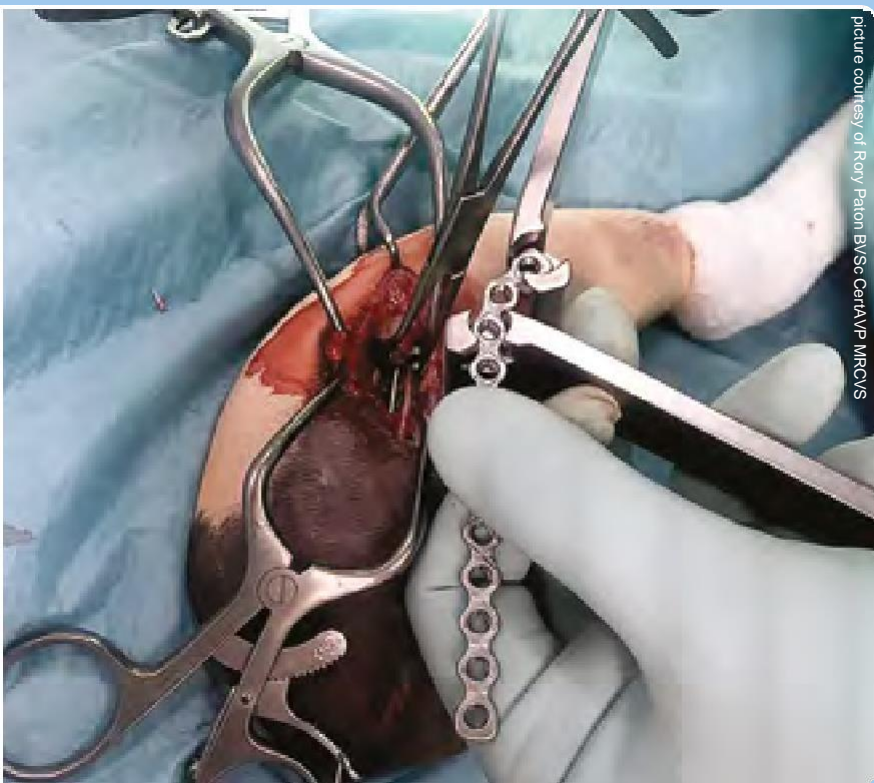

	Page
2.4mm Evolox® Cuttable & Cuttable Malleable Plates	134
2.7mm Evolox® Osteosynthesis Plates	134
3.5mm Evolox® Osteosynthesis Plates	136
3.5mm Evolox® Broad Plates	140
3.5mm PCL Evolox® (Poly-axial Compression Locking Plate)	142
2.4mm Evolox® Poly-Axial Compression Locking Plate	144
2.7mm Evolox® Poly-Axial Compression Locking Plate	144
2.4mm Evolox® Biological Healing Plates	146
3.5mm Evolox® Biological Healing Plates	146
Evolox® GEN2 Acetabular	146
Evolox® YY Plates	148
Circular Cuttable Locking Plates	148
Evolox® Gen-2 Hybrid T-Plates	149
Pancarpal and Pantarsal Evolox®	150
Evolox® Pancarpal Arthrodesis Plates Special All Locking (PAL)	150
Evolox® Canine Cranial Pantarsal Arthrodesis Plate	152
Evolox® Feline Pantarsal Plate Cranial Position	152
Evolox® TPLO	154
Evolox® 2.4mm TPLO Version 2	156
Evolox 2.4mm Closing Wedge TPLO Plates	156
Evolox® 3.5mm TPLO Small	157
Evolox® 3.5mm TPLO Heavy	157
Evolox® TPLO Poly-Axial Proximal Hole	158
Evolox® TPLO Mono-Axial Proximal Hole	158
Evolox® TPLO Closing Wedge	158
TPLO Evolox® Delta 'Style' Plates	160
Dual Direction Compression (DDC) Evolox® Locking Plates	161
3.5mm Evolox® DDC	161
Evolox® Supracondylar Osteotomy Plates	162
Evolox® Partial Carpal Arthrodesis	162
Evolox® 3.5mm Distal Radius T-Plate	162
RP (Rory Paton) TPLO Plate	164-165

Evolox® Poly Axial Locking System

Evolox® Locking System

Designed to offer the surgeon a flexible solution for a wide range of fixation including, but not limited to Humerous, Femur, Ulna and Tibia.

The **Evolox®** System progresses the established mon axial locking technology to the next level through its unique and innovative design. The surgeon now has freedom in the angular (Poly axial) placement of fixation screws, whilst still allowing complex, multi plane contouring of the plate to take place. The design of the tapered twin start threaded locking hole allows the use of both conventional (ISO 5835) Cortical (Cortex)/Cancellous Bone Screws*, and compatible Locking Screws or any combinations. Unlike other angular locking systems available, there is no metal cutting involved in the locking of the screw head to the plate. This allows for easy removal or replacement.



Conventional screws do not lock into the plate, but locate into the spherical recess above the **Evolox® feature.*

N2 only use fully Class IIB Implantable Stainless Steel to ISO 5832-1

N2 only recommend using fully compatible bone screws in our Evolox Implants due to competitive products not following our standards of quality and compatibility.



Evolox® is a registered Trademark of N2(UK)Ltd
Evolox® and **Evolox®** Gen2 is protected technology by international Law and Patents Pending

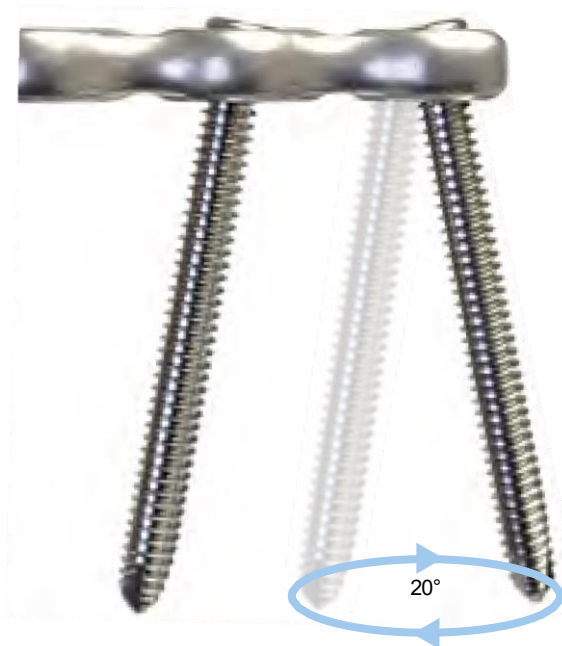

Benefits

Reduced soft tissue irritation

Low profile plates with smooth rounded edges reduce soft tissue irritation, and aid wound closure.

Crumple zones

Plates in the **Evolox**[®] range that require anatomical bending are designed with crumple zones that control the movement of the material during manipulation, and direct distortion away from the locking holes. Locking plugs should be used for added protection.

Secure fixation

The **Evolox**[®] technology creates a locked construct when used in conjunction with a compatible locking screw, providing angular stability, and a reduced risk of primary and secondary losses of reduction.

Plate bending

The need to bend the plates to an accurate anatomical form prior to implantation is greatly reduced as the need to generate compressive forces between plate and bone is not required. The **Evolox**[®] technology can be angled toward the fragment and still create a stable fixation. The reduced bending requirement also helps to retain the full strength of the plate, and protect it from stress risers that can cause premature implant failure.

Preservation of blood supply

Locking plates do not need to be compressed against the bone to create a stable fixation, thus reducing plate to bone contact, which in turn reduces complications caused by vascular trauma to periosteal tissue.

Fragment reduction

The **Evolox**[®] technology allows individual fragment fixation by allowing the screws to angle and lock towards the core of the bone rather than be limited to the perpendicular axis of the plate. This gives the plate coverage for multiple fracture configurations.

Satin Finish

In addition to the obvious non-reflective surface providing less light glare during surgery, the uniform surface layer of compressive stress acts to combat stress cracks and corrosion, therefore, increasing the life of implant. Also this type of surface finish has a greater ultrasound reflection. The process itself cleans the part, leaving it free from residues with a low CFU (microorganism) count, resulting in easier autoclave sterilisation.



Standard Operating Procedures for Evolox® Osteosynthesis Fixation of Fractures

Kindly Prepared by: Aiz Baig BVSc, MBA, MRCVS

Humerus - Elbow 'Y' or 'T'

Combined medial and lateral approaches. Anatomic reconstruction with lag screws, K wires etc. Fracture reduction of the articular surface should be confirmed by direct visualization.

If only locking screws are used, contouring of the plate is generally not required. The use of Locking Drill Guides is recommended to ensure correct screw trajectory. The Locking Drill Guides can also be used as handles to help position the plate. Drill through the guide hole to the desired depth using an appropriate sized drill bit. Measure the hole depth via a depth gauge. Remove the Locking Drill Guide and insert the appropriate length Locking Screw using a screwdriver. Do not use power tools to insert the locking screws.

If non-locking screws (cortex or cancellous) are used in the plate, the following precautions are necessary:

Since conventional screws pull bone to the plate, contouring of the plate may be required to enhance bone-plate contact. If non-locking screws are used in combination with locking screws, non-locking screws must be adequately inserted and fully tightened prior to locking screw(s) insertion.

Note: Contouring of the plate will alter the angle of the locking screws. It is recommended to insert locking plugs prior to contouring to avoid distortion of internal threads.

Two Evolox Osteosynthesis Plates, one medial and one lateral. Total of 4 Evolox Osteosynthesis Platescrews in reconstructed condylar fragment (not necessary to have all 4 screws in the same Evolox Osteosynthesis Plate). Total of 4 screws in proximal major fragment (not necessary to have all 4 screws in the same Evolox Osteosynthesis Plate). Two x 2.7mm Evolox Osteosynthesis Plates in patients up to 20 kg. Two x 3.5mm Evolox Osteosynthesis Plates in patients over 35 kg. Fill any empty holes with a locking plug.

Femur – Diaphysis

If only locking screws are used, contouring of the plate is generally not required. The use of Locking Drill Guides is recommended to ensure correct screw trajectory. The Locking Drill Guides can also be used as handles to help position the plate. Drill through the guide hole to the desired depth using an appropriate sized drill bit. Measure the hole depth via a depth gauge. Remove the Locking Drill Guide and insert the appropriate length Locking Screw using a screwdriver. Do not use power tools to insert the locking screws.

If non-locking screws (cortex or cancellous) are used in the plate, the following precautions are necessary:

Since conventional screws pull bone to the plate, contouring of the plate may be required to enhance bone-plate contact. If non-locking screws are used in combination with locking screws, non-locking screws must be adequately inserted and fully tightened prior to locking screw(s) insertion.

Note: Contouring of the plate will alter the angle of the locking screws. It is recommended to insert locking plugs prior to contouring to avoid distortion of internal threads.

4 screws in distal and 4 screws in proximal fragments. Single 2.7mm Evolox Osteosynthesis Plate in patients up to 10 kg (medial aspect). Single 3.5mm Evolox Osteosynthesis Plate in patients up to 35 kg (lateral aspect). Double 3.5mm Evolox Osteosynthesis Plate in patients over 35 kg (lateral aspect). Fill any empty holes with a hole plug. If only locking screws are used in the plate absolute anatomical contouring is not necessary.

Tibia – Diaphysis

If only locking screws are used, contouring of the plate is generally not required. The use of Locking Drill Guides is recommended to ensure correct screw trajectory. The Locking Drill Guides can also be used as handles to help position the plate. Drill through the guide hole to the desired depth using an appropriate sized drill bit. Measure the hole depth via a depth gauge. Remove the Locking Drill Guide and insert the appropriate length Locking Screw using a screwdriver. Do not use power tools to insert the locking screws.

If non-locking screws (cortex or cancellous) are used in the plate, the following precautions are necessary:

Since conventional screws pull bone to the plate, contouring of the plate may be required to enhance bone-plate contact. If non-locking screws are used in combination with locking screws, non-locking screws must be adequately inserted and fully tightened prior to locking screw(s) insertion.

Note: Contouring of the plate will alter the angle of the locking screws. It is recommended to insert locking plugs prior to contouring to avoid distortion of internal threads.

4 screws in distal and 4 screws in proximal fragments. Single 2.7mm Evolox Osteosynthesis Plate in patients up to 10 kg (medial aspect). Single 3.5mm Evolox Osteosynthesis Plate in patients up to 35 kg (medial aspect). Double 3.5mm Evolox Osteosynthesis Plate in patients over 35 kg (medial aspect). Fill any empty holes with a hole plug. If only locking screws are used in the plate absolute anatomical contouring is not necessary.

Ulna - Radius

If only locking screws are used, contouring of the plate is generally not required. The use of Locking Drill Guides is recommended to ensure correct screw trajectory. The Locking Drill Guides can also be used as handles to help position the plate. Drill through the guide hole to the desired depth using an appropriate sized drill bit. Measure the hole depth via a depth gauge. Remove the Locking Drill Guide and insert the appropriate length Locking Screw using a screwdriver. Do not use power tools to insert the locking screws.

If non-locking screws (cortex or cancellous) are used in the plate, the following precautions are necessary:

Since conventional screws pull bone to the plate, contouring of the plate may be required to enhance bone-plate contact. If non-locking screws are used in combination with locking screws, non-locking screws must be adequately inserted and fully tightened prior to locking screw(s) insertion.

Note: Contouring of the plate will alter the angle of the locking screws. It is recommended to insert locking plugs prior to contouring to avoid distortion of internal threads.

Evolox Osteosynthesis Plateon radius (4 screws in proximal and 4 screws in distal fragment). Evolox Osteosynthesis Plateon medial or dorsal aspect distally. Evolox Osteosynthesis Plate on cranial aspect proximally. Avoid overlong screws transfixing radius and ulna. 2.7mm Evolox Osteosynthesis Platein patients up to 10 kg. 3.5mm Evolox Osteosynthesis Platein patients over 10 kg. Fill any empty holes with a hole plug. If only locking screws are used in the plate absolute anatomical contouring is not necessary.

Relative Contraindications

The veterinarian's education, training and professional judgement must be relied upon to choose the most appropriate surgical implant and treatment. The following contraindications should be taken into account by the veterinarian:

- Any active or suspected latent infection or marked local inflammation in or about the surgical site.
- Compromised vascularity that would inhibit sufficient blood supply to the fracture site.
- Bone stock compromised by pathology prior to application that cannot provide adequate support and/or fixation of the implants.
- Implant sensitivity, documented or suspected.
- Obesity. An overweight animal can produce loads on the implant that can lead to failure of the surgical procedure or the implant itself.
- Animals having insufficient soft tissue coverage over the operative site.
- Implant application that would interfere with normal anatomical structures and range of motion.
- Any neuromuscular pathology that would create an unacceptable risk of fixation failure or postoperative complications.
- Other medical or surgical conditions which would preclude the potential benefit of surgery.

Maximum recommended torque for tapered screw head engagement:

3.5mm Locking screw = 2.30 N-mm (0.02 lbf-in)

2.7mm Locking screw = 1.15 N-mm (0.01 lbf-in)

Over tightening the screw may result in threads stripping, and loss of secure fixation.

In this event replace the over tightened screw with a conventional cortical screw.

Secure fixation can be achieved with much lower torque levels using locking screw technology.

2.4mm Evolox® Cuttable & Cuttable Malleable Plates

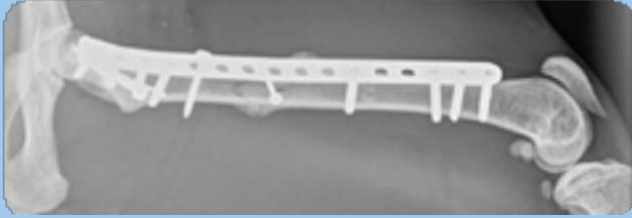
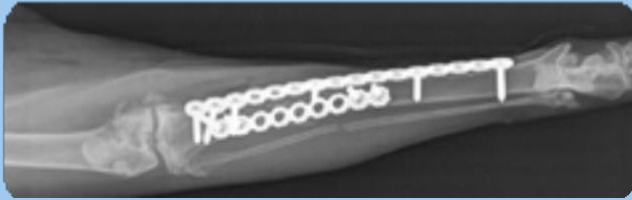

Order Code	No. of Holes	Length mm	RRP
EV-CMP-24-25-150	25	150	£105.00
EV-CUT-24-25-150	25	150	£105.00

Will accept

2.4mm Cortical,
2.2mm Cancellous,
2.4mm Locking
(Hex or/and Star Torx Drive),
2024 Hybrid Locking,
2.7mm Locking

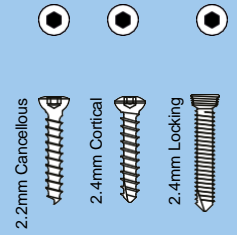

2.7mm Evolox® Osteosynthesis Plates

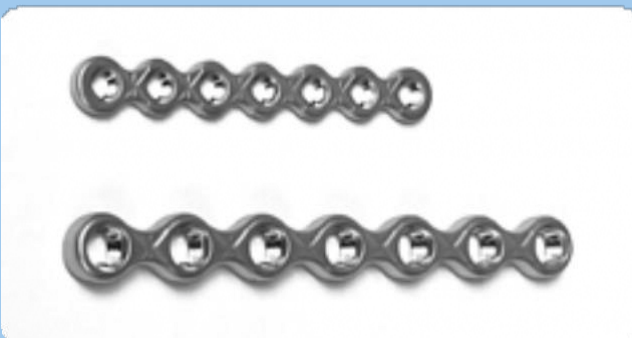
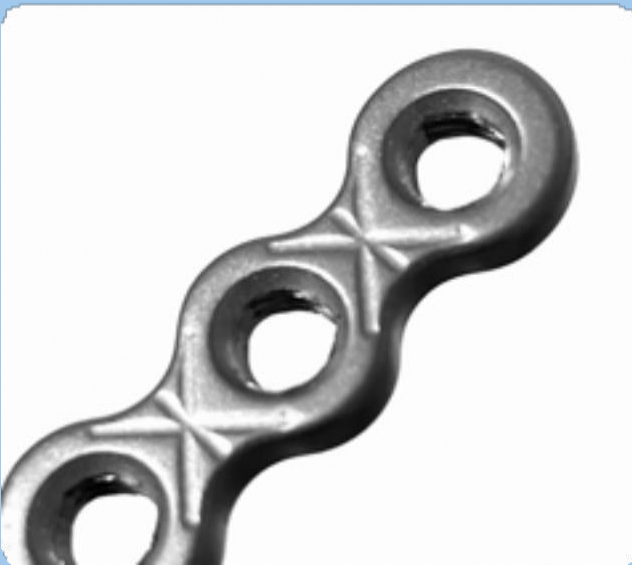

Order Code	No. of Holes	Length mm	RRP
EV-OS-27-04	4	34	£52.50
EV-OS-27-05	5	40	£63.00
EV-OS-27-06	6	48	£73.50
EV-OS-27-07	7	56	£84.00
EV-OS-27-08	8	64	£94.50
EV-OS-27-09	9	72	£105.00
EV-OS-27-10	10	80	£115.50
EV-OS-27-11	11	88	£126.00
EV-OS-27-12	12	96	£136.50
EV-OS-27-13	13	104	£147.00
EV-OS-27-14	14	112	£157.50
EV-OS-27-15	15	120	£168.00
EV-OS-27-16	16	128	£178.50

Will accept

2.7mm Cortical,
3mm Cancellous,
2.4mm Locking
(Hex or/and Star Torx Drive),
2024 Hybrid Locking,
2.7mm Locking

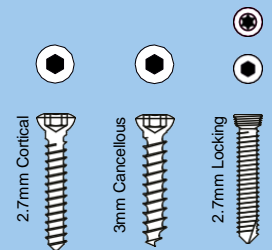

2.4mm Evolox® Cuttable Malleable Plate



EV-CMP-24-25-150

2.4mm Evolox® Cuttable Plate



EV-CUT-24-25-150

2.7mm Evolox® Osteosynthesis Plates



EV-OS-27-04



EV-OS-27-05



EV-OS-27-06



EV-OS-27-07



EV-OS-27-08



EV-OS-27-09



EV-OS-27-10



EV-OS-27-11



EV-OS-27-12



EV-OS-27-13



EV-OS-27-14



EV-OS-27-15



EV-OS-27-16

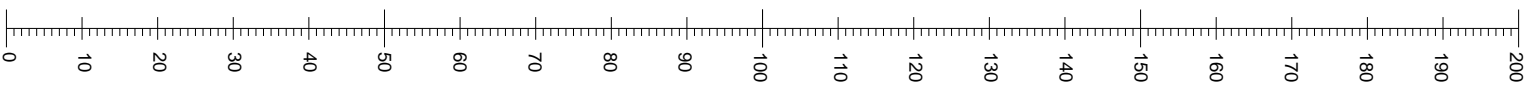

3.5mm Evolox® Osteosynthesis Plates



Order Code	No. of Holes	Length mm	RRP
EV-OS-35-04	4	45	£52.50
EV-OS-35-05	5	57	£63.00
EV-OS-35-06	6	69	£73.50
EV-OS-35-07	7	81	£84.00
EV-OS-35-08	8	93	£94.50
EV-OS-35-09	9	105	£105.00
EV-OS-35-10	10	117	£115.50
EV-OS-35-11	11	129	£126.00
EV-OS-35-12	12	141	£136.50
EV-OS-35-13	13	153	£147.00
EV-OS-35-14	14	165	£157.50
EV-OS-35-15	15	177	£168.00
EV-OS-35-16	16	189	£178.50
EV-OS-35-17	17	201	£189.00
EV-OS-35-18	18	213	£199.50
EV-OS-35-19	19	225	£210.00
EV-OS-35-20	20	238	£220.50

Will accept

3.5mm Cortical, 4mm Cancellous,
3.5mm Locking (Hex or/and Star
Torx Drive)

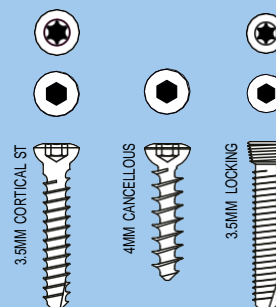

Evolox® is a registered Trademark of N2(UK)Ltd

Evolox® and Evolox® Gen2 is protected technology
by international Law and Patents Pending



3.5mm Evolox® Osteosynthesis Plates



EV-OS-35-16



EV-OS-35-15



EV-OS-35-14



EV-OS-35-13



EV-OS-35-12



EV-OS-35-11



EV-OS-35-10



EV-OS-35-09



EV-OS-35-08



EV-OS-35-07



EV-OS-35-06



EV-OS-35-05



EV-OS-35-04

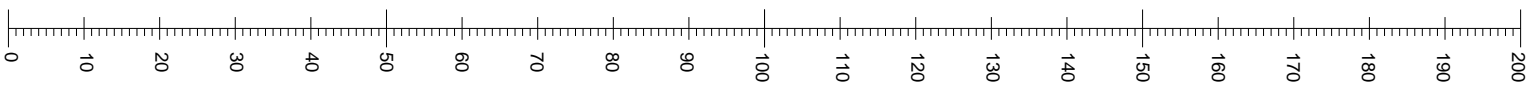

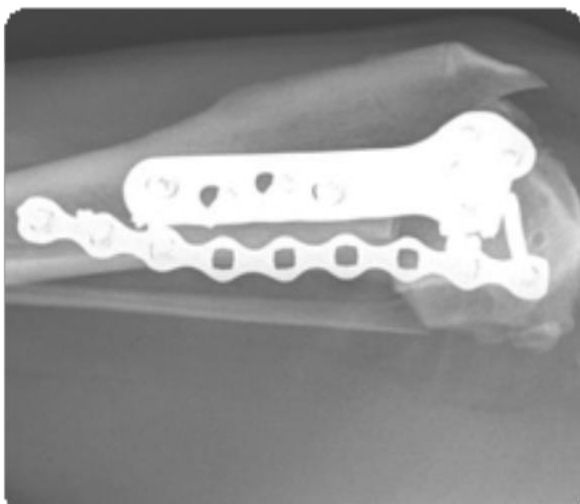
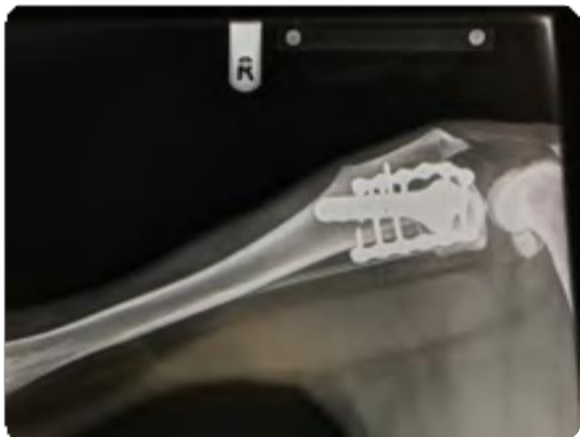

Results EVO LOX Component

- EVO LOX part was tested with SS 316 LVM
- Results show that the bar starts yielding at a load of 625N
- With a Proof Load of 702N according to the methodology in BS 3531
- Top figure shows stress distribution and deflection at maximum load.
- Bottom two figures show stress and deflection at yield

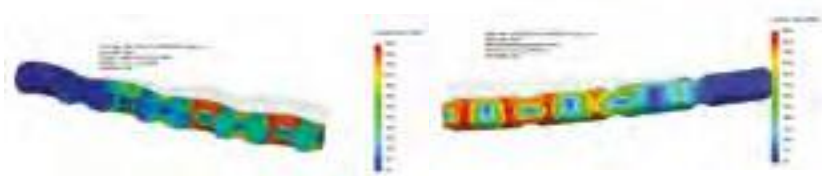

Results EVO LOX Component

- EVO LOX part was tested with SS 316 LVM .
- Due to the fact that the design of the EVO LOX allows for up to 10 degrees of twist when attached to the screws the first step in the FEA analysis was a central bend of 15 degrees by carrying out a 3 point bend on the part.
- Figure shows the mesh of the EVO LOX 316LVM component bent to 15 degrees.





Registered / Registrato 19/02/2014

No 012176954

**OHIM – OFFICE FOR HARMONIZATION IN THE
INTERNAL MARKET
TRADE MARKS AND DESIGNS**

CERTIFICATE OF REGISTRATION

This Certificate of Registration is hereby issued for the Community Trade Mark identified below. The corresponding entries have been recorded in the Register of Community Trade Marks.

**UAMI – UFFICIO PER L'ARMONIZZAZIONE NEL
MERCATO INTERNO
MARCHI, DISEGNI E MODELLI**

CERTIFICATO DI REGISTRAZIONE

Si rilascia il presente certificato di registrazione per il marchio comunitario identificato in appresso. I dati ad esso relativi sono stati iscritti nel Registro dei Marchi Comunitari.

EVOLOX

The President / Il Presidente



António Campinos

3.5mm Evolox® Broad Plates



A wider version of the Standard Plates by 2mm when a more substantial fixation is desirable. Still with all the benefits of the standard plate but offering further rigidity and starting size is 4 holes.

Order Code	No. of Holes	Length mm	RRP
EV-OS-35-04B	4	32	£63.00
EV-OS-35-05B	5	59	£73.50
EV-OS-35-06B	6	71	£84.00
EV-OS-35-07B	7	83	£94.50
EV-OS-35-08B	8	95	£105.00
EV-OS-35-09B	9	107	£115.50
EV-OS-35-10B	10	119	£126.00
EV-OS-35-11B	11	131	£136.50
EV-OS-35-12B	12	143	£147.00
EV-OS-35-13B	13	155	£157.50
EV-OS-35-14B	14	167	£168.00
EV-OS-35-15B	15	179	£178.50
EV-OS-35-16B	16	191	£189.00
EV-OS-35-17B	17	203	£199.50
EV-OS-35-18B	18	215	£210.00
EV-OS-35-19B	19	227	£220.50
EV-OS-35-20B	20	239	£231.00

Will accept

3.5mm Cortical, 4mm Cancellous,
3.5mm Locking (Hex or/and Star
Torx Drive)

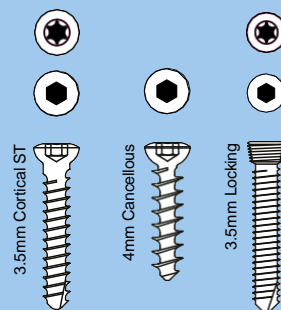

Evolox® is a registered Trademark of N2(UK)Ltd

Evolox® and Evolox® Gen2 is protected technology
by international Law and Patents Pending

3.5mm Evolox® Broad Plates



EV-OS-35-09B



EV-OS-35-08B

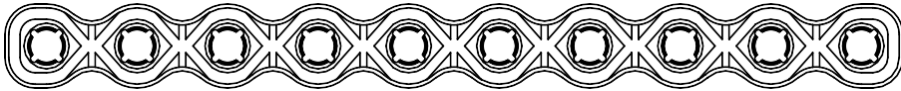

EV-OS-35-10B



EV-OS-35-07B



EV-OS-35-11B



EV-OS-35-06B

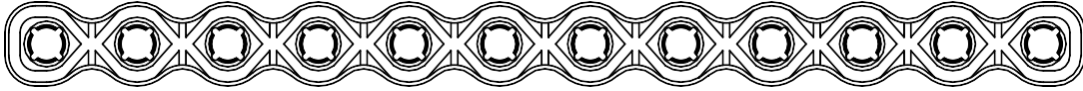

EV-OS-35-12B



EV-OS-35-05B



EV-OS-35-13B



EV-OS-35-04B



EV-OS-35-14B



EV-OS-35-15B

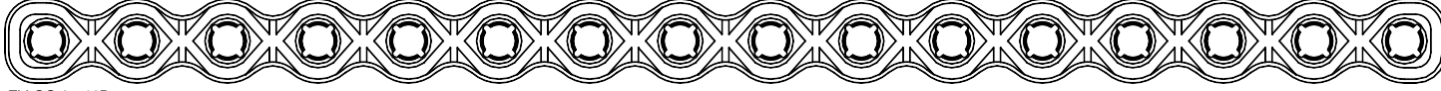

EV-OS-35-16B



EV-OS-35-17B



EV-OS-35-18B



EV-OS-35-19B



EV-OS-35-20B





Poly-Axial Compression Plates

3.5mm PCL Evolox® (Poly-axial Compression Locking Plate)

A dedicated heavy duty plate for long Bone fractures requiring minimal contouring but maximum strength.
Rigid Extruded Profile Construct.

Some Key points

-  Single locating fixing
-  Compression
-  Poly-Axial Evolox Locking Plate

Order Code	No. of Holes	Length mm	RRP
EV-PCL-35-06	6	81	£57.80
EV-PCL-35-07	7	93	£62.00
EV-PCL-35-08	8	105	£66.20
EV-PCL-35-09	9	117	£70.40
EV-PCL-35-10	10	129	£74.60
EV-PCL-35-11	11	141	£78.80
EV-PCL-35-12	12	153	£83.00
EV-PCL-35-13	13	165	£87.20
EV-PCL-35-14	14	177	£91.40
EV-PCL-35-15	15	189	£95.60
EV-PCL-35-16	16	201	£99.80

Will accept

3.5mm Cortical, 4mm Cancellous,
3.5mm Locking (Hex or/and Star
Torx Drive)

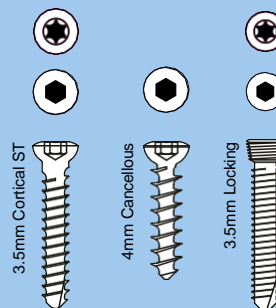

Evolox® is a registered Trademark of N2(UK)Ltd

Evolox® and Evolox® Gen2 is protected technology
by international Law and Patents Pending



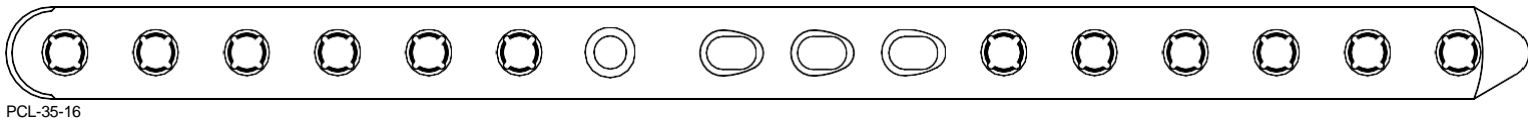
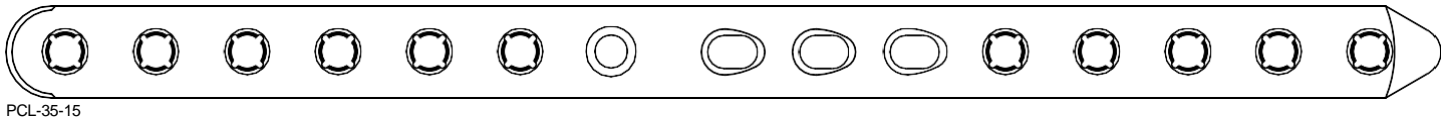
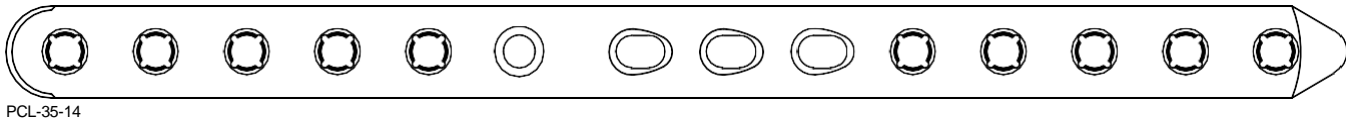
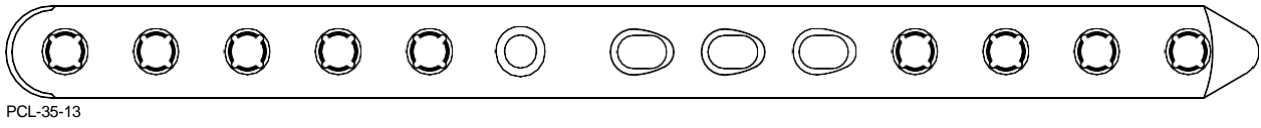
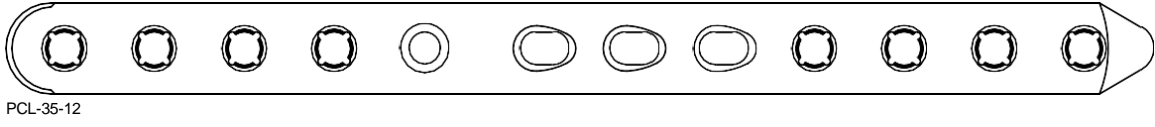
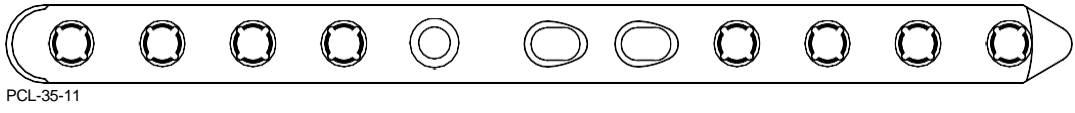
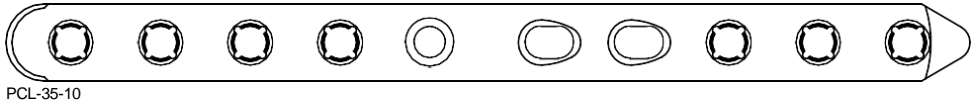
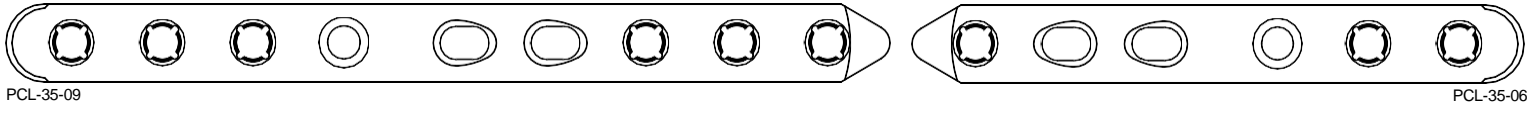
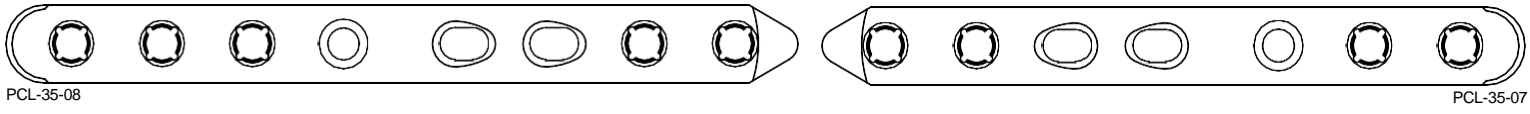

Poly-Axial Locking

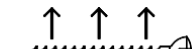
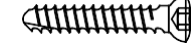

Poly-Axial Locking

Fixed

Compression

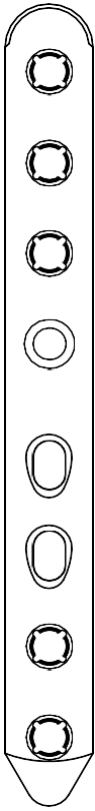
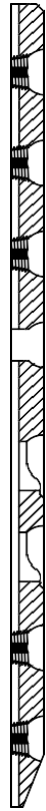

3.5mm PCL Evolox®
(Poly-axial
Compression
Locking Plate)

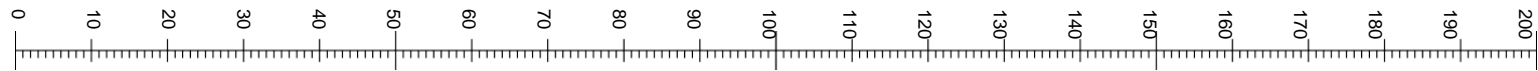

Evolox® Poly/Mono-Axial Compression Locking Plates

PCL

These Unique plates were requested by surgeons to offer the flexibility of Poly-Axial Locking and a combination of compression and secure fixation. The use of Evolox® Locking greatly increases pull out resistance and offers enhanced Screw placement while offering a rigid construct. The need to perfectly contour the plate anatomically is reduced by the angulation of the Evolox® Locking Hole.

Our plates are made from specific Bone Plate Profiles (ISO 5832-1) increasing strength while reducing potential fatigue. Our Human grade material has almost twice the tensile strength of our competitors 316L Stainless Steel.

They are a cost effective solution to reduce inventory and have tapered ends for clear identification.

2.4mm Evolox® Poly-Axial Compression Locking Plate (EV-PCL-24-XXX)

You can use 2.4mm ISO Regular Locking Screws, 2.4mm Cortical Screws or a mixture of both.

Designed to also take 3mm Cancellous Screws and 2.4mm Locking Screws with 2mm shaft depending on the quality of the bone or revision.

2.7mm Evolox® Poly-Axial Compression Locking Plate (EV-PCL-27-XXX)

You can use 2.7mm ISO Regular Locking Screws, 2.7mm Cortical Screws or a mixture of both.

Designed to also take 3mm Cancellous Screws and 2.4mm Locking Screws, or a 2.4mm Locking Screw with 2mm shaft.

Order Code	Description	RRP
MCL-20-05	2.0mm Locking and Compression Plates 5 Hole X 30mm	£36.80
MCL-20-06	2.0mm Locking and Compression Plates 6 Hole X 35mm	£39.90
MCL-20-07	2.0mm Locking and Compression Plates 7 Hole X 40mm	£43.10
MCL-20-08	2.0mm Locking and Compression Plates 8 Hole X 45mm	£47.30
MCL-20-09	2.0mm Locking and Compression Plates 9 Hole X 50mm	£50.40
MCL-20-10	2.0mm Locking and Compression Plates 10 Hole X 55mm	£52.50
MCL-20-11	2.0mm Locking and Compression Plates 11 Hole X 60mm	£54.60
MCL-20-12	2.0mm Locking and Compression Plates 12 Hole X 65mm	£56.70
MCL-20-13	2.0mm Locking and Compression Plates 13 Hole X 70mm	£58.80
MCL-20-14	2.0mm Locking and Compression Plates 14 Hole X 75mm	£60.90

EV-PCL-24-05	2.4mm Evolox® Locking and Compression Plates 5 Hole X 41mm	£47.30
EV-PCL-24-06	2.4mm Evolox® Locking and Compression Plates 6 Hole X 48mm	£49.40
EV-PCL-24-07	2.4mm Evolox® Locking and Compression Plates 7 Hole X 55mm	£52.50
EV-PCL-24-08	2.4mm Evolox® Locking and Compression Plates 8 Hole X 62mm	£55.70
EV-PCL-24-09	2.4mm Evolox® Locking and Compression Plates 9 Hole X 69mm	£58.80
EV-PCL-24-10	2.4mm Evolox® Locking and Compression Plates 10 Hole X 76mm	£62.00
EV-PCL-24-11	2.4mm Evolox® Locking and Compression Plates 11 Hole X 83mm	£65.10
EV-PCL-24-12	2.4mm Evolox® Locking and Compression Plates 12 Hole X 90mm	£68.30

EV-PCL-27-06	2.7mm Evolox® Locking and Compression Plates 6 Hole X 59mm	£56.70
EV-PCL-27-07	2.7mm Evolox® Locking and Compression Plates 7 Hole X 67mm	£59.90
EV-PCL-27-08	2.7mm Evolox® Locking and Compression Plates 8 Hole X 75mm	£63.00
EV-PCL-27-09	2.7mm Evolox® Locking and Compression Plates 9 Hole X 83mm	£66.20
EV-PCL-27-10	2.7mm Evolox® Locking and Compression Plates 10 Hole X 91mm	£69.30
EV-PCL-27-11	2.7mm Evolox® Locking and Compression Plates 11 Hole X 99mm	£72.50
EV-PCL-27-12	2.7mm Evolox® Locking and Compression Plates 12 Hole X 107mm	£75.60

MCL-20-05



MCL-20-06



MCL-20-07



MCL-20-08



MCL-20-09



MCL-20-10



MCL-20-11



MCL-20-12



MCL-20-13



MCL-20-14



EV-PCL-27-06



EV-PCL-27-07



EV-PCL-27-08



EV-PCL-27-09



EV-PCL-27-10



EV-PCL-27-11



EV-PCL-27-12

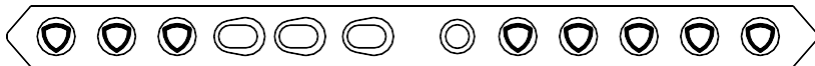

EV-PCL-27-13

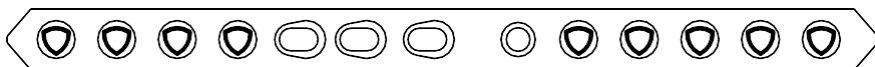

EV-PCL-27-14



EV-PCL-27-15



EV-PCL-27-16



C: Secure Stability B: Compress A: Fix C: Secure Stability

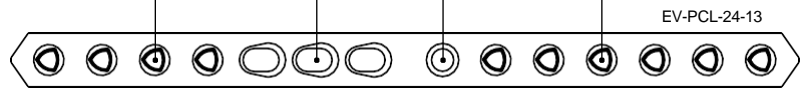

EV-PCL-24-13

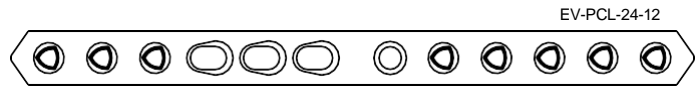

EV-PCL-24-12

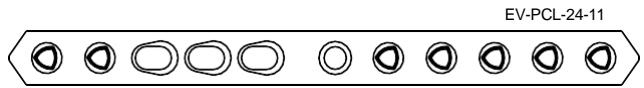

EV-PCL-24-11

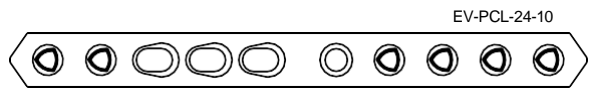

EV-PCL-24-10

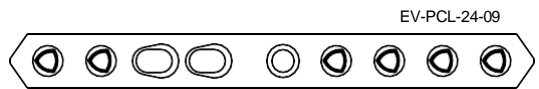

EV-PCL-24-09

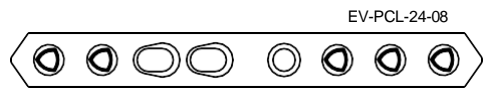

EV-PCL-24-08

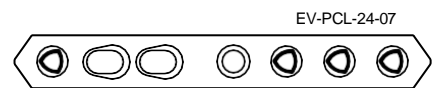

EV-PCL-24-07

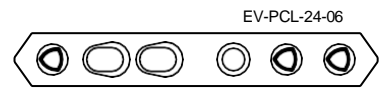

EV-PCL-24-06

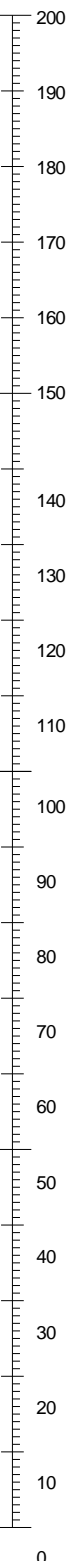

2.4mm Evolox® Biological Healing Plates

The 2.4mm Plates are specifically designed for economical use on Feline Long Bone fractures. They benefit from a rigid extruded construct with the flexibility of having Poly-axial Locking fixation or even 2.4mm Locking Screws with 2mm shaft. They are low profile and pre contoured to aid closure.

Order Code	Description	RRP
EV-BH-24-07-059	2.4mm Biological Healing Plate 7 Holes 59mm Long	£47.30
EV-BH-24-08-084	2.4mm Biological Healing Plate 8 Holes 84mm Long	£47.30



Evolox® is a registered Trademark of N2(UK)Ltd

3.5mm Evolox® Biological Healing Plates

Order Code	No. of Holes	Length mm	RRP
EV-BH-35-08-154	8	154	£42.00
EV-BH-35-08-142	8	142	£42.00
EV-BH-35-07-130	7	130	£42.00
EV-BH-35-07-120	7	120	£42.00

Will accept

3.5mm Cortical,
4mm Cancellous,
3.5mm Locking
(Hex or/and Star Torx Drive)

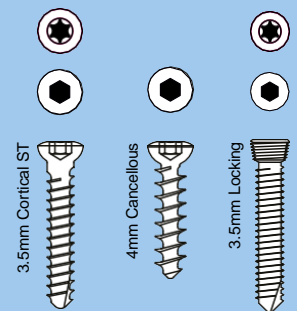

Evolox® GEN2 Acetabular

Order Code	No. of Holes	Length mm	RRP
EV-ACE-24	4	21	£52.50
EV-ACE-24B	4	26	£52.50
EV-ACE-27	4	33	£63.00
EV-ACE-27B	4	36	£63.00
EV-ACE-35	6	46	£68.30

2.4mm Version will accept 2.4mm Cortical, 2.2mm Cancellous, 2.4mm Locking (Hex or/and Star Torx Drive), 2.7mm locking, 2.4/2.0 Hybrid Locking

2.7mm Version will accept 2.7mm Cortical, 3mm Cancellous, 2.7/2.4mm Locking (Hex or/and Star Torx Drive), 2.4/2.0 Hybrid Locking

3.5mm Version will accept 3.5mm Cortical, 4mm Cancellous, 3.5mm Locking (Hex or/and Star Torx Drive)



Evolox® and Evolox® Gen2 is protected technology by international Law and Patents Pending

2.4mm Evolox® Biological Healing Plates



EV-BHP-24-07-059



EV-BHP-24-08-084

3.5mm Evolox® Biological Healing Plates



EV-BH-08-154

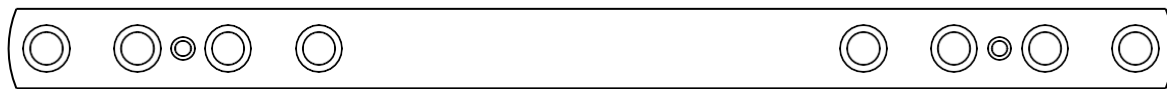

EV-BH-08-154



EV-BH-08-142

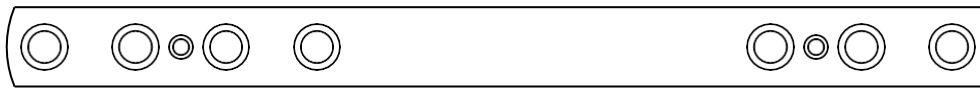

EV-BH-07-130



EV-BH-07-120

Evolox® GEN2 Acetabular



EV-ACE-24



EV-ACE-24B



EV-ACE-27



EV-ACE-27B



EV-ACE-35

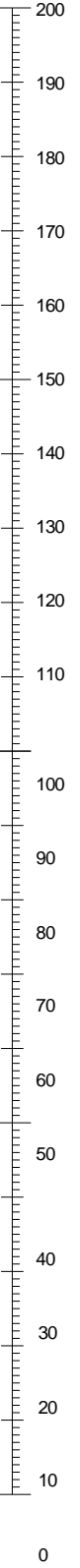

Evolox® YY Plates

Originally designed for a chondrodystrophic bi-apical antebrachial deformity that had caused paw rotation in a Basset hound this plate was designed to stabilise both ends of the realigned area. The plate is useful for other procedures in particular the distal radius.

Order Code	Description	RRP
EV-YY-27-12	2.7mm EVOLOX® 12 Hole Double Ended Y Plate	£168.00
EV-YY-27-13	2.7mm EVOLOX® 13 Hole Double Ended Y Plate	£168.00
EV-YY-27-14	2.7mm EVOLOX® 14 Hole Double Ended Y Plate	£168.00

2mm YY locking plates see page 55

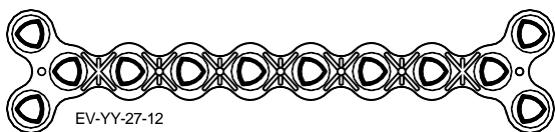

scale 1:1

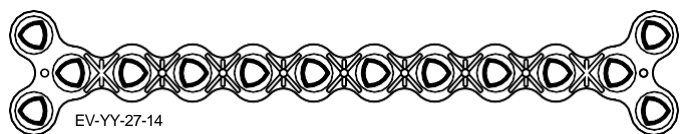
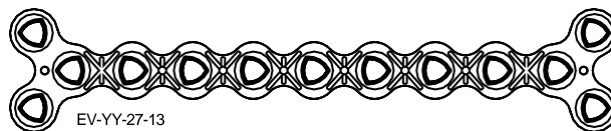

Circular Cuttable Locking Plates

A unique versatile plate to have available. Whether it is for acetabular work or maxillofacial work this range will be useful. They have been used in jaw fractures as well as around the orbit. This cuttable option offers flexibility to allow all your requirements to be met in one plate.

Order Code	Description	RRP
LPL-RP-20-36-24	2.0mm Locking Ring Plate 24 Hole 36mm Diameter (Mono-axial)	£147.00
EV-RP-24-57-24	2.4mm EVOLOX® Ring Plate 24 Hole 57mm Diameter	£157.50
EV-RP-27-82-24	2.7mm EVOLOX® Ring Plate 24 Hole 82mm Diameter	£168.00



scale 1:1

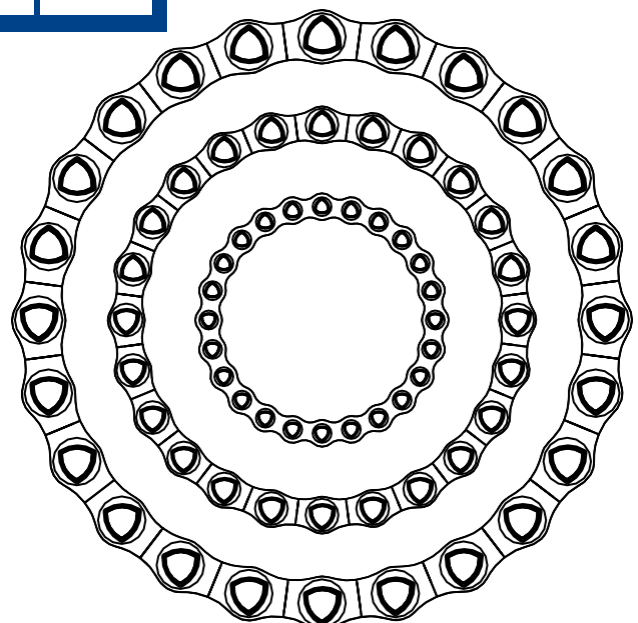

Evolox® Gen-2 Hybrid T-Plates

We have added a range of Hybrid T-Plates with our Evolox® polyaxial locking holes as requested by veterinary surgeons.

Code	Head Locking screw size	Shaft Locking screw size	Shaft DCP screw size	Length	RRP
EV-HTP-27-35-72	2.7	3.5	3.5	72	£73.50
EV-HTP-27-35-95	2.7	3.5	3.5	95	£94.50
EV-HTP-27-35-105	2.7	3.5	3.5	105	£99.80
EV-HTP-27-35-85	2.7	3.5	3.5	85	£78.80
EV-HTP-27-35-65	2.7	3.5	3.5	65	£63.00
EV-HTP-24-24-71	2.4	2.4	2.4	71	£73.50
EV-HTP-24-24-52	2.4	2.4	2.4	52	£63.00
EV-HTP-24-5-3	2.4	2.4	2.4	57	£68.00

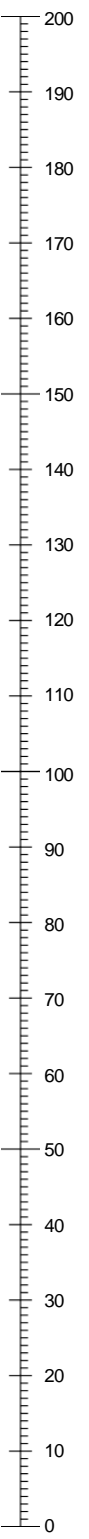
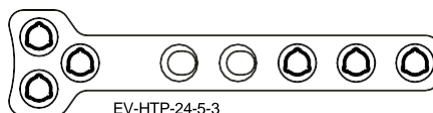
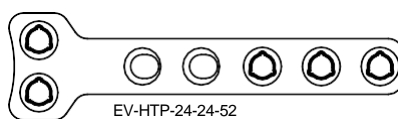
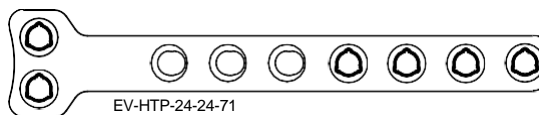
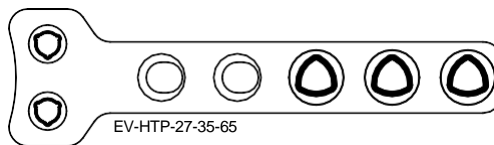
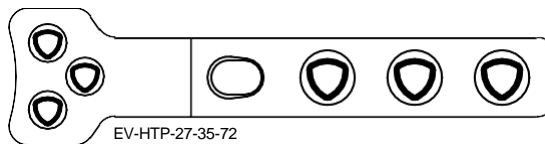
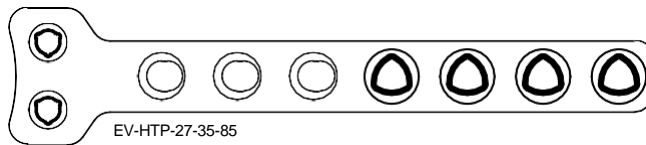
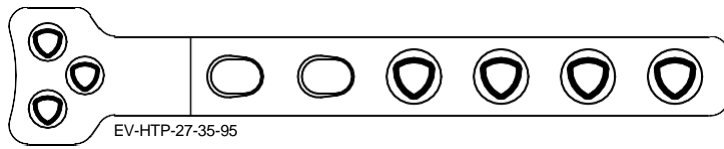
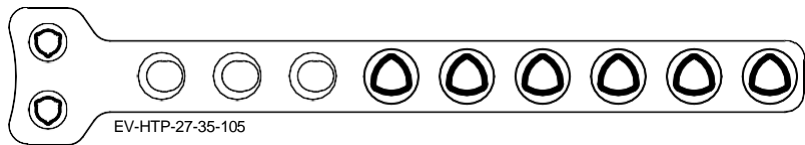

Pancarpal and Pantarsal Evolox®

We have launched a range of Pancarpal and Pantarsal Plates with Poly-Axial Holes included to give surgeons more flexibility in screw placement.

Order Code	Description	RRP
EV-PAN-27-35-135-TR-XS (Small)	Evolox® Pancarpal Arthrodesis Plate 2.7mm x 3.5mm 135 Degrees Right with Slot - SHORT	£99.80
EV-PAN-27-35-135-TR	Evolox® Pancarpal Arthrodesis Plate 2.7mm x 3.5mm 135 Degrees Standard Right with Slot	£99.80
EV-PAN-27-35-135-TL-XS (Small)	Evolox® Pancarpal Arthrodesis Plate 2.7mm x 3.5mm 135 Degrees Left with Slot - SHORT	£99.80
EV-PAN-27-35-135-TL	Evolox® Pancarpal Arthrodesis Plate 2.7mm x 3.5mm 135 Degrees Standard Left with Slot	£99.80
EV-PAN-20-27-135-TR	Evolox® Pancarpal Arthrodesis Plate 2.0mm x 2.7mm 135 Degrees Right with Slot	£99.80
EV-PAN-20-27-135-TL	Evolox® Pancarpal Arthrodesis Plate 2.0mm x 2.7mm 135 Degrees Left with Slot	£99.80
EV-PAN-20-27-120-TR	Evolox® Pancarpal Arthrodesis Plate 2.0mm x 2.7mm 120 Degrees Right with Slot	£99.80
EV-PAN-20-27-120-TL	Evolox® Pancarpal Arthrodesis Plate 2.0mm x 2.7mm 120 Degrees Left with Slot	£99.80

Order Code	Description	RRP
EV-PAD-27-35L	Evolox® 2.7mm/3.5mm Pancarpal Arthrodesis Plate Evolox and Compression 118mm	£70.40
EV-PAD-27-35-PB-L	Evolox® 2.7/3.5mm Pancarpal Arthrodesis DCP Plate Extra Long Pre Bent 7 deg	£88.20
EV-PAD-27-35-PB	Evolox® 2.7/3.5mm Pancarpal Arthrodesis DCP Plate Pre Bent 7 deg	£88.20
EV-PAD-27-35	Evolox® 2.7mm/3.5mm Pancarpal Arthrodesis Plate Evolox and Compression 100mm	£70.40
EV-PAD-20-27L	Evolox® 2.0/2.7mm Pancarpal Arthrodesis Plate, Locking and Compression 90mm	£59.90
EV-PAD-20-27-PB	Evolox® 2.0/2.7mm Pancarpal Arthrodesis DCP Plate Pre Bent 7 deg	£88.20
EV-PAD-20-27	Evolox® 2.0/2.7mm Pancarpal Arthrodesis Plate Evolox, Locking and Compression 75mm	£59.90

Evolox® Pancarpal Arthrodesis Plates Special All Locking (PAL)

We have produced quite a few of this plates over the past two years as a bespoke special implant. The demand has enabled us to produce this plate as a 'Off the Shelf' stock item thus reducing lead times and benefitting the patient. All holes are locking and can be pre-contoured upon request.

Order Code	Description	RRP
LPL-PAL-20-20XL	2.0/2.0mm Mono-Axial locking 67mm	£70.40
EV-PAL-20-27	2.0/2.7mm Evolox® Pancarpal Arthrodesis 75mm	£70.40
EV-PAL-27-35XL	2.7/3.5mm Evolox® Pancarpal Arthrodesis 118mm	£73.50
EV-PAL-35-35	3.5/3.5mm Evolox® Pancarpal Arthrodesis 141mm	£73.50



Evolox® is a registered Trademark of N2(UK)Ltd

Evolox® and Evolox® Gen2 is protected technology by international Law and Patents Pending

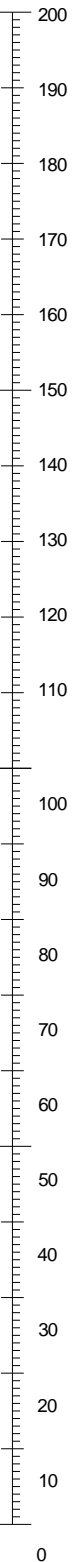
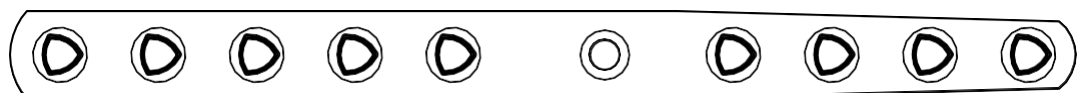
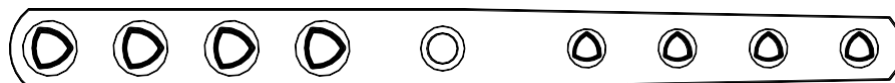
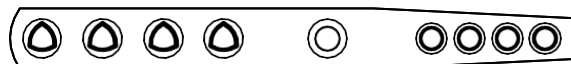
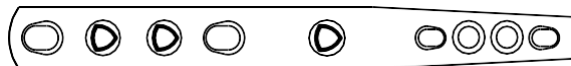
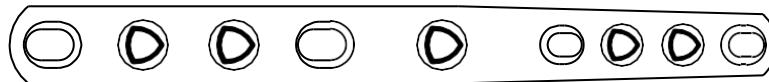
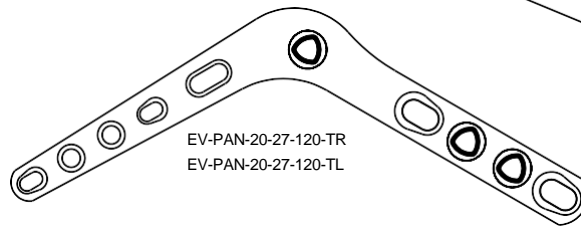
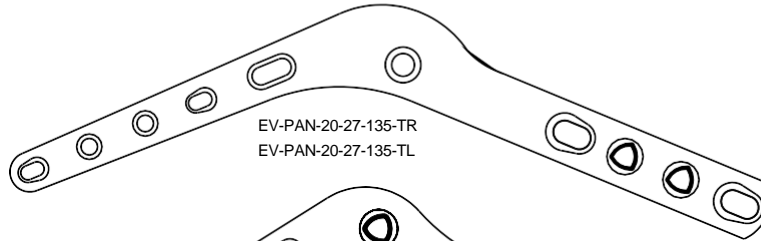
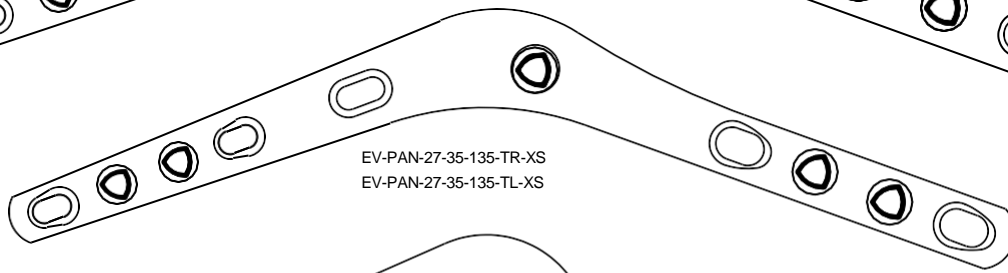
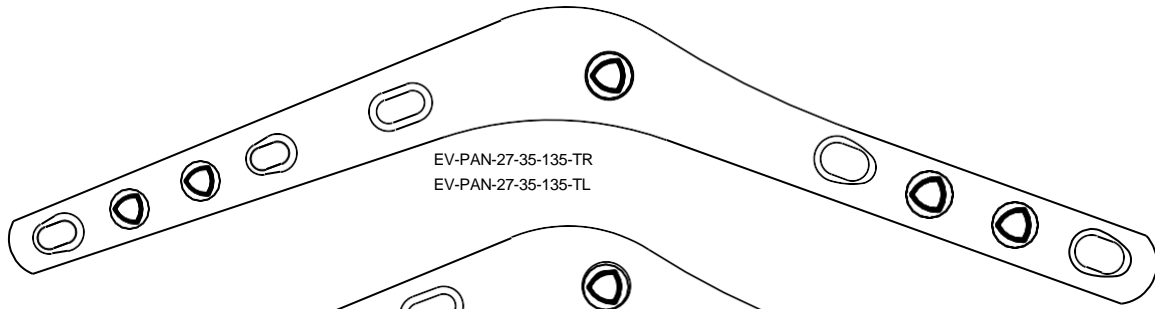

Evolox[®] Canine Cranial Pantarsal Arthrodesis Plate

Our Evolox[®] CPA plates offer the reassurance of having a locking construct with the benefit of compression as needed.

Order Code	Screw Size	RRP
EV-CPA-27-35-140	2.7 / 3.5	£140.00
EV-CPA-20-27-140	2.0 / 2.7	£120.00

3.5mm/2.7mm Pre contoured to 135° to reduce stress risers. Profile 12mm X 4 MM for added strength. 140°

2.0/2.4/2.7mm Pre contoured to 140° to reduce stress risers. Profile 8mm X 2.5MM for added strength. 140°

An improved plate with increased screw placement angulation in elliptical slots similar in design of Limited contact slots. The oblique undercut for improved range of inclination either side of the bend greatly improves screw placement to secure the talus.

New range has the added advantage of reduce profile height to aid closure without affecting torsional strength.

Larger compression slots in the Tibia than the metatarsal and tapered to suit.

All Plates are made from Stainless Steel ISO 5832-1



Evolox[®] Feline Pantarsal Plate Cranial Position

Order Code	Screw Size	RRP
EV-CPA-20-20-120	2.0 / 2.0	£108.00
EV-CPA-20-24-120	2.0 / 2.4	£108.00
EV-CPA-20-27-120	2.0 / 2.7	£108.00

2.0mm/2.0mm Dimensions are 5mm wide by 2mm thick, tapering to 1.5mm pre bent at 120° to reduce stress risers.

2.0mm/2.4mm Dimensions are 6.5mm wide by 2mm thick, tapering to 1.5mm pre bent at 120° to reduce stress risers.

2.0mm/2.0mm Dimensions are 8mm wide by 2mm thick, tapering to 1.5mm pre bent at 120° to reduce stress risers.

Larger compression slots in the Tibia than the metatarsal and tapered to suit.

All Plates are made from Stainless Steel ISO 5832-1

Evolox® Canine Cranial 140° Pantarsal Arthrodesis Plates

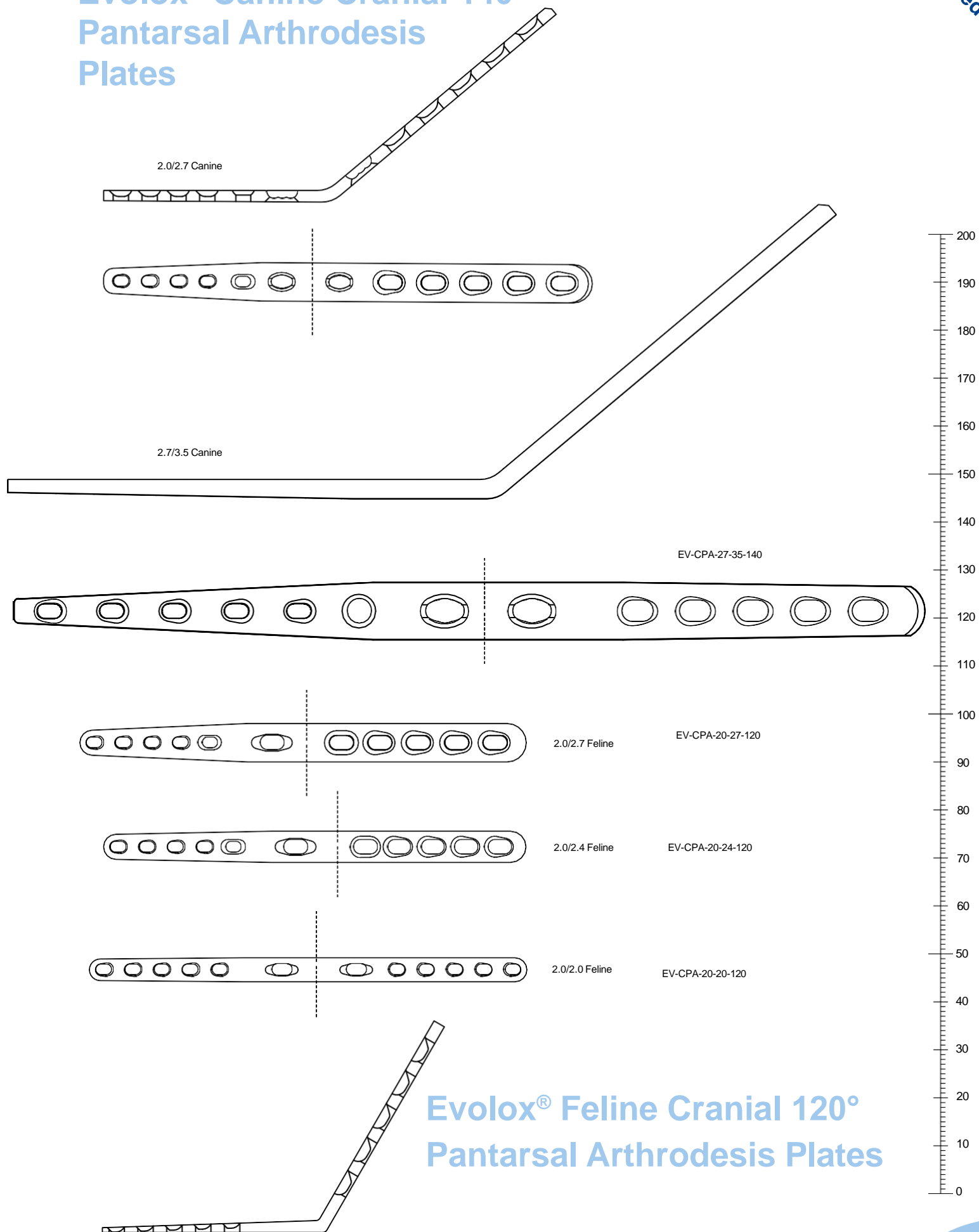

Evolox® Feline Cranial 120° Pantarsal Arthrodesis Plates

Evolox[®] TPLO

TPLO surgery continues to grow and many options are open to the surgeon. Our new plate was two years in the making and has certainly evolved in numerous aspects compared to standard TPLO plates using the same radial cut

The use of **Evolox[®]** Poly-axial Locking Technology with Cranial and Caudal Screw Placement helps to eliminate operation inaccuracies. The Proximal screw is fixed angled.

Gen 2 Evolox[®]

The latest advancement in Evolox poly-axial locking technology is unlike any previous medical thread form seen in the market place.

The usual method to achieve poly-axial locking is to either:

1. Create interrupts (breaks) in the thread form, thus allowing the mating thread to pass through the gap to the next thread.
2. Self-cut the screw thread into the plate.

The method in system 1 incurs far less complications with removal of the screw and implant, as system 2 requires the plate to be of a softer material than the screw which then cold fuses the screw to the plate. This is what makes the screw difficult to remove. Also the softer plate is inherently weaker than if using harder material. This method is usually reserved for Titanium products, using pure Titanium on the plate and alloyed Titanium on the screws.

System 1 can have limitations, as the interrupts in thread form reduce the thread strength and can result in thread stripping if subjected to excessive load after placement or excessive torque during placement. Thread stripping although uncommon will weaken the overall construct. To avoid this occurrence where excessive load after placement is anticipated, it is usual to advise an increase in the plate size to the next range, ie 2.7mm to 3.5mm or 3.5mm to 3.5mm broad etc.

This is not always ideal for many reasons, including wound closure and poor bone stock.

For this reason, N2 UK Ltd have strived to overcome this problem and increased the scope of its useability through innovative design and complex machining strategies. We are pleased to say that after several designs and prototypes we have achieved our goal.

Our 2nd generation Evolox[®] hole system (patent pending) uses a unique twin start tapered triangular thread form that naturally generates the space required to allow the threads to skip to the next level, thus maintaining a continuous thread form and drastically improving the rigidity of the locking interface.

(Please note that it is critical to fill all holes with either a screw or a plug, and follow the torque guidelines)



X-rays courtesy of Christchurch Referrals



Evolox[®] is a registered Trademark of N2(UK)Ltd

Evolox[®] and **Evolox[®] Gen2** is protected technology by international Law and Patents Pending



www.n2-uk.com

Evolox[®] TPLO

Some key points are:

- ▲ Protected Triangular uninterrupted thread form for Poly-axial Locking.
- ▲ Unique. Durable. Flexible.
- ▲ Uses standard Twin Start Locking and conventional Cortical(Cortex)/ Cancellous screws.
- ▲ More precise Compression Angled towards the Osteotomy.
- ▲ Limited Contacts Areas for increased Vascular flow.
- ▲ Lower profile with tapered end and smooth rounded edges.
- ▲ Deformation Grooves.
- ▲ Anatomically Shaped.
- ▲ Available in 6 sizes from 2.4 to 3.5mm Broad. All Handed Left or Right.
- ▲ Satin Finish with Polished Threads.

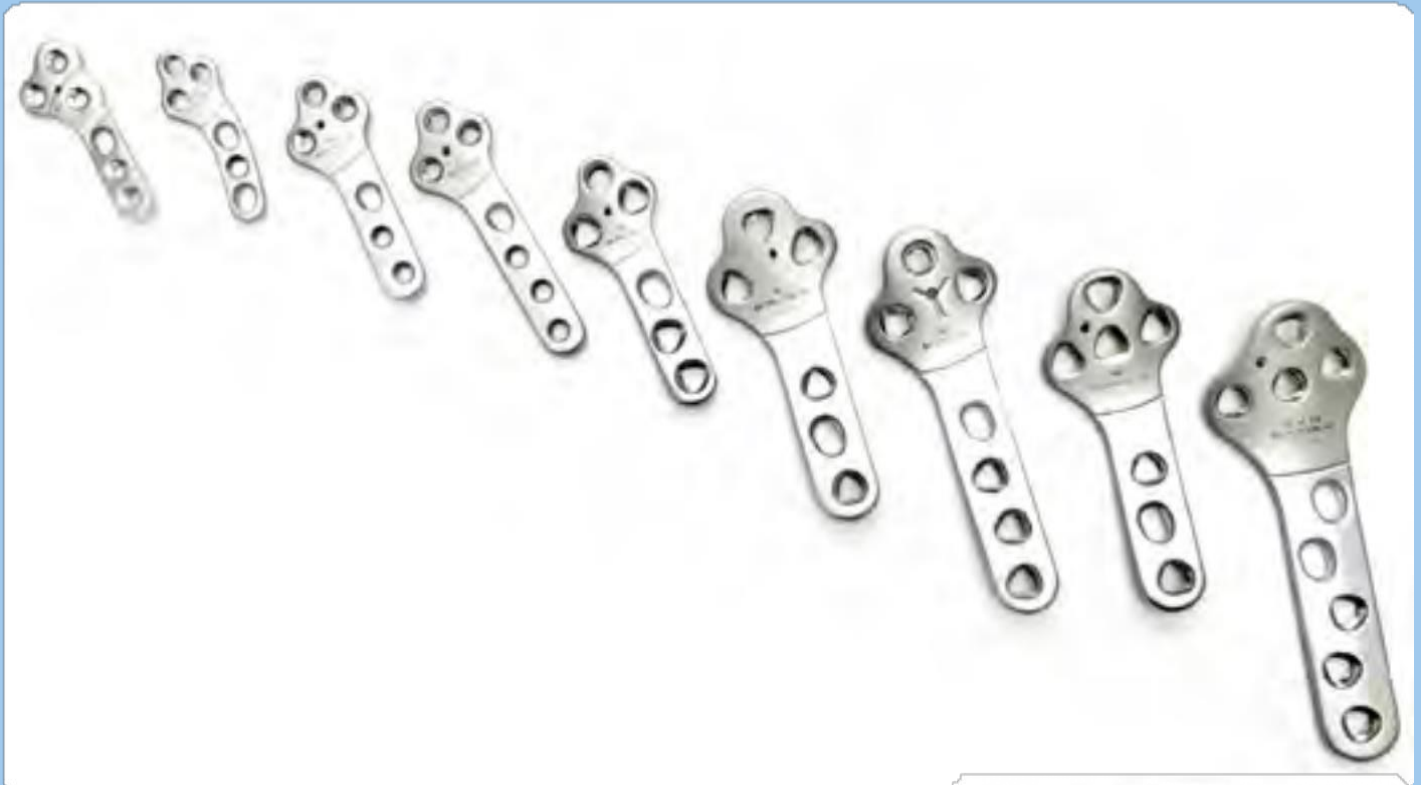



EVOLOX® 2.4mm TPLO Version 2

This completely re-engineered and reconfigured TPLO Plate incorporates a range of technical features designs for greater osteotomy stability and reduced healing times

New Head Features:

- All **Evolox®** screw holes allowing enhanced freedom of screw orientation and optimal bone purchase
- **Evolox®** proximal screw hole configuration ensures joint space avoidance even where contouring of the plate is necessary
- New curved profile ensures head-screw holes overlie osteotomised tibial fragment allowing more central screw placement in the thickest available bone

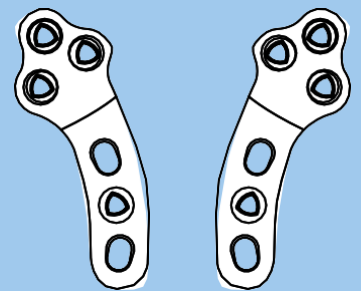

scale 1:1

New Shaft features:

- Angled proximal compression hole perpendicular to the osteotomy line ensures correct compression of the central zone
- Offset distal compression hole ensures compression of the proximal zone of the osteotomy
- Single central **Evolox®** hole reducing implant costs

Our Version One Evolox® 2.4mm TPLO Plate is still available and remains a premier choice for the closing wedge technique (using left as right and visa versa)

EVOLOX® 2.4mm Closing Wedge TPLO plates

Used for both closing wedge and Slocum Style the 2.4 plate is a versatile plate for smaller patients. Its in the closing wedge method that the plate really comes into its won.

"I prefer Wedge TPLO for small breeds with steep plateaus, and I use a controlateral N2 2.4mm locking/compression TPLO plate - put a right sided plate on a left stifle. The proximal triangular offset hole is therefore cranial, and sits really nicely towards the tibial crest."

**Dr. Colin Whiting BVSc CertSAS MRCVS RCVS
Recognised Advanced Practitioner in Small Animal**

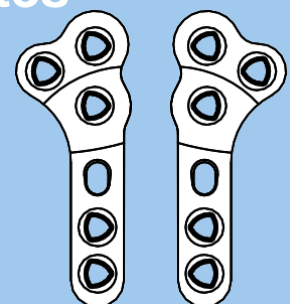

"I find it fits the anatomy beautifully for a wedge, if used back to front then you get a linear arrangement of locking screws at the caudal (widest) part of the tibia, with an extra screw cranially to take advantage of the anatomy of the proximal tibia. It certainly fits better for a CCWO than the modern TPLO plates (which work far better for slocum), and polyaxial ability is useful in such small anatomy. It's the only plate I use in small dogs for ccwo."

**Jamie McClement BVSc MSc CertSAS MRCVS RCVS
Advanced Practitioner in Small Animal Surgery**

Images Courtesy of Matt Hibberd BVSc Cert AVP(GSAS) MRCVS Rata Vets

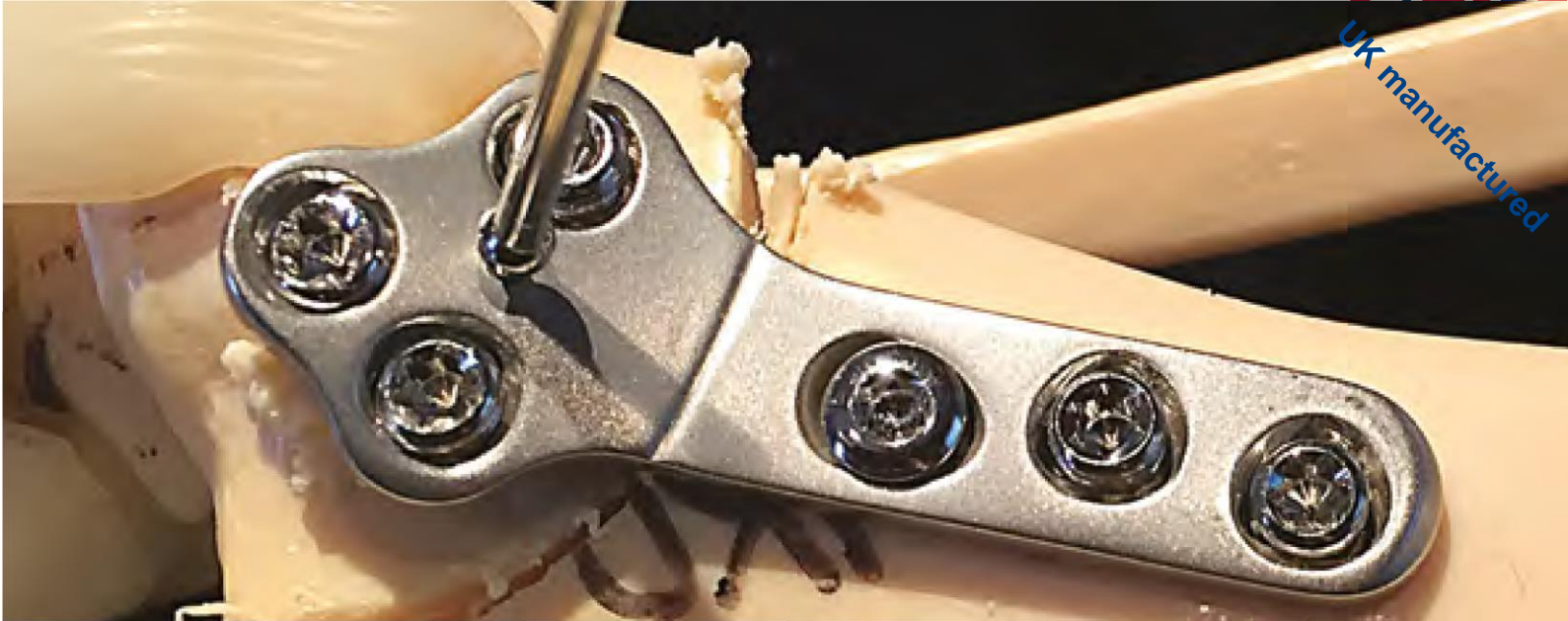

EVOLOX® 3.5mm TPLO Small

The 3.5mm mini plate is designed to fit small stocky dogs such as a Staffordshire Bull Terrier and other breeds weighing between 18-24kg and fills the jump in size between 2.7mm plates and 3.5mm standard plates.

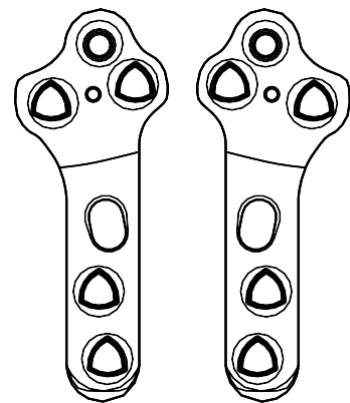

scale 1:1



Evolox® 3.5mm TPLO Heavy

"Introducing the new Evolox® 3.5mm heavyweight standard plate. Indicated for patients requiring a little extra security beyond that of the standard 3.5mm V2 plate. The heavyweight standard plate has an extra Screw hole in the head to allow Poly-Axial placement of 4 locking Screws in the osteotomised fragment without any additional increase in plate dimensions".

The circumstances where N2 would recommend this plate are:

- Overweight dogs where the tibia is too small to accept a broad plate.
- Very active and younger dogs where patient/owner compliance with post-operative aftercare may be challenged.

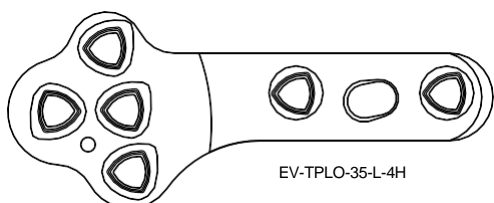

EV-TPLO-35-L-4H

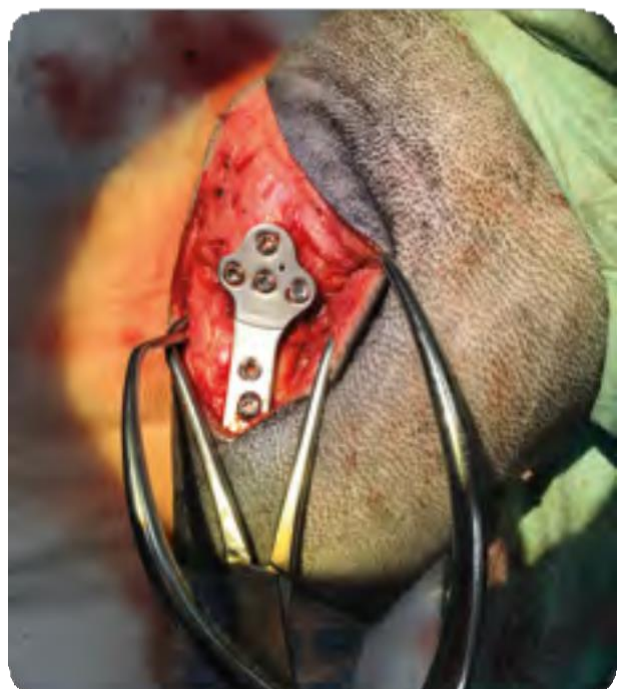

Patrick Curriuan
MVB GPCertSAS CertAVP(GSAS) MRCVS

Evolox[®] TPLO

Evolox[®] TPLO Poly-Axial Proximal Hole

We know everyone has different techniques and preferences when doing TPLO. We have tried to accommodate the variation with our PAP and MAP ranges.

Both types are identical in size, screw location etc the only difference is the PAP has a polyaxial proximal hole to allow surgeons to set their own screw angulation (useful where plate tweaks are used) and MAP where the proximal hole is monoaxial and pre-set to angle away from the joint, allowing the surgeon to be guided by the plate angulation.

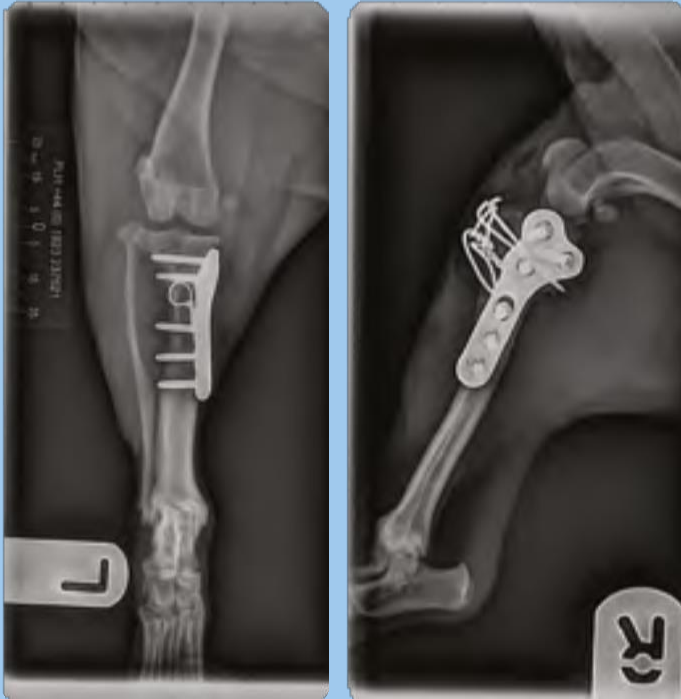

Order Code	No. of Holes	Length mm	RRP
EV-TPLO-24L-V2	3+3	37.5	£63.00
EV-TPLO-24R-V2	3+3	37.5	£63.00
EV-TPLO-27L V2	3+3	46	£68.30
EV-TPLO-27R V2	3+3	46	£68.30
EV-TPLO-35-LS V2	3+3	50	£73.50
EV-TPLO-35-RS V2	3+3	50	£73.50
EV-TPLO-35-L V2	3+3	64	£68.30
EV-TPLO-35-R V2	3+3	64	£68.30
EV-TPLO-35-L-4H	3+4	64	£73.50
EV-TPLO-35-R-4H	3+4	64	£73.50
EV-TPLO-35BL V2	4+5	85	£84.00
EV-TPLO-35BR V2	4+5	85	£84.00

Evolox[®] TPLO Mono-Axial Proximal Hole

Order Code	No. of Holes	Length mm	RRP
EV-TPLO-27R	3+3	46	£63.00
EV-TPLO-27L	3+3	46	£63.00
EV-TPLO-27RL	3+4	54	£63.00
EV-TPLO-27LL	3+4	54	£63.00
EV-TPLO-35-LS	3+3	50	£68.30
EV-TPLO-35-RS	3+3	50	£68.30
EV-TPLO-35RL	3+4	74	£68.30
EV-TPLO-35LL	3+4	74	£68.30
EV-TPLO-35R	3+3	64	£68.30
EV-TPLO-35L	3+3	64	£68.30
EV-TPLO-35BR	4+5	85	£73.50
EV-TPLO-35BL	4+5	85	£73.50

Creeping Wedge

Order Code	No. of Holes	Length mm	RRP
EV-CW-TPLO-24R	3+3	39	£63.00
EV-CW-TPLO-24L	3+3	39	£63.00

For Stabilising pin with olive please see page 49

Evolox[®] is a registered Trademark of N2(UK)Ltd



Evolox[®] and Evolox[®] Gen2 is protected technology by international Law and Patents Pending

Evolox® TPLO Poly-Axial Proximal Hole

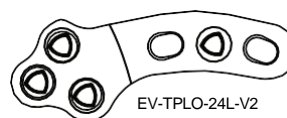
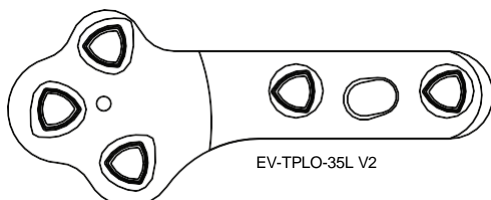
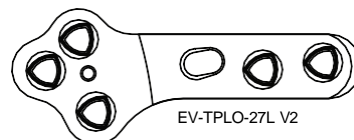
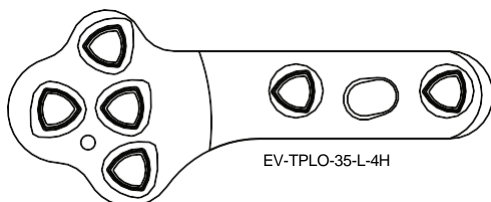
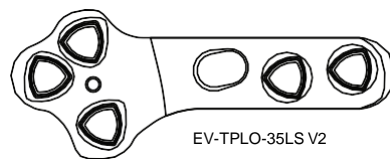
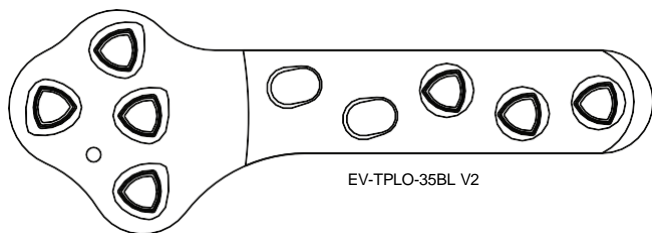

Evolox® TPLO Mono-Axial Proximal Hole

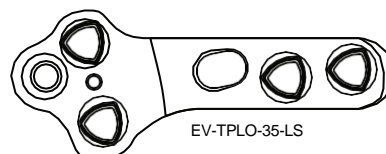
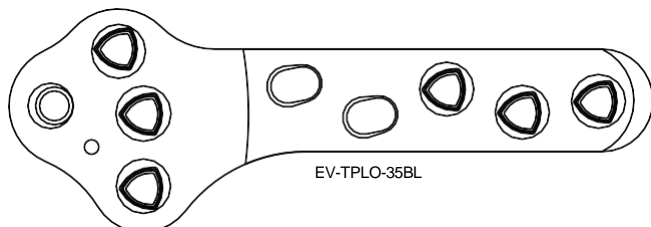
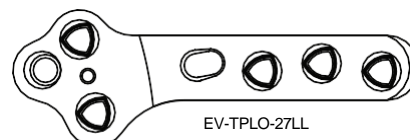
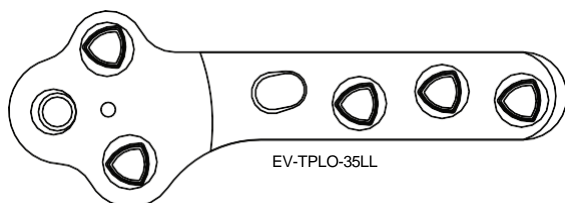
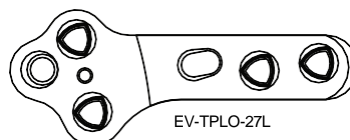
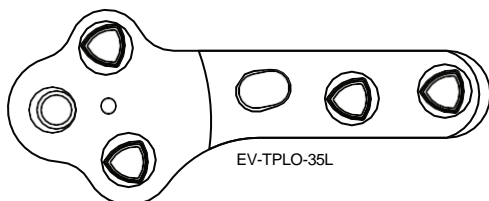

Evolox® TPLO Closing Wedge

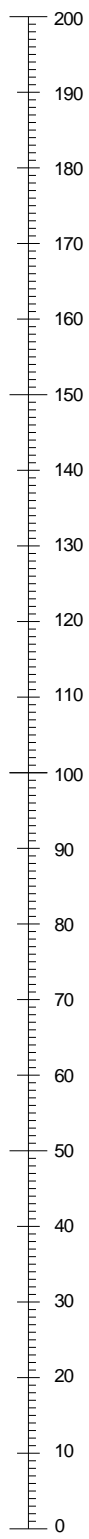
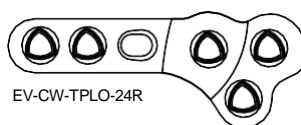
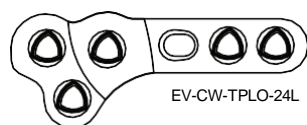

TPLO Evolox® Delta 'Style' Plates

Order Code	Ø Screw mm	RRP
EV-TPLO-DEL-35-L	3.5+Locking	£68.30
EV-TPLO-DEL-35-R	3.5+Locking	£68.30

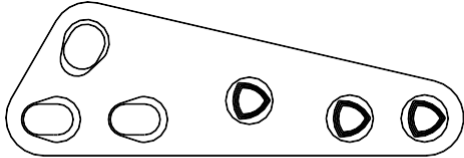

EV-TPLO-DEL-35-L

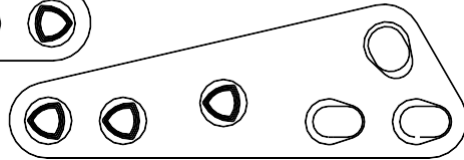

EV-TPLO-DEL-35-R

Order Code	Ø Screw mm	RRP
EV-TPLO-DEL-27-R	2.7+Locking	£66.20
EV-TPLO-DEL-27-L	2.7+Locking	£66.20

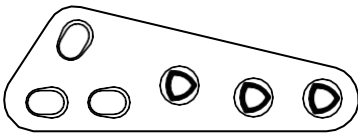

EV-TPLO-DEL-27-L

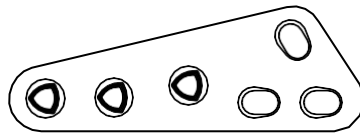

EV-TPLO-DEL-27-R

Dual Direction Compression (DDC) Evolox® Locking Plates

A cleverly designed, unique heavy duty plate offering left and right compression from the same slot across the length of the plate. Made from pre contoured profile and also benefits from Evolox Poly-Axial Locking Screw triangular threads. This heavy duty plate offers a solution for comminuted fractures on long bone.

- Works with standard compression slot drill guides.
- Will accept 3.5mm Cortical, Locking or 4mm Cancellous Screws.

3.5mm Evolox® DDC

Order Code	Description	RRP
EV-DDC-35-15	3.5mm Dual Direction Evolox® Locking Compression 15H X 232mm	£147.00
EV-DDC-35-16	3.5mm Dual Direction Evolox® Locking Compression 16H X 247 mm	£168.00
EV-DDC-35-17	3.5mm Dual Direction Evolox® Locking Compression 17H X 262 mm	£189.00
EV-DDC-35-18	3.5mm Dual Direction Evolox® Locking Compression 18H X 277 mm	£210.00



Pictures courtesy of Christchurch Referrals

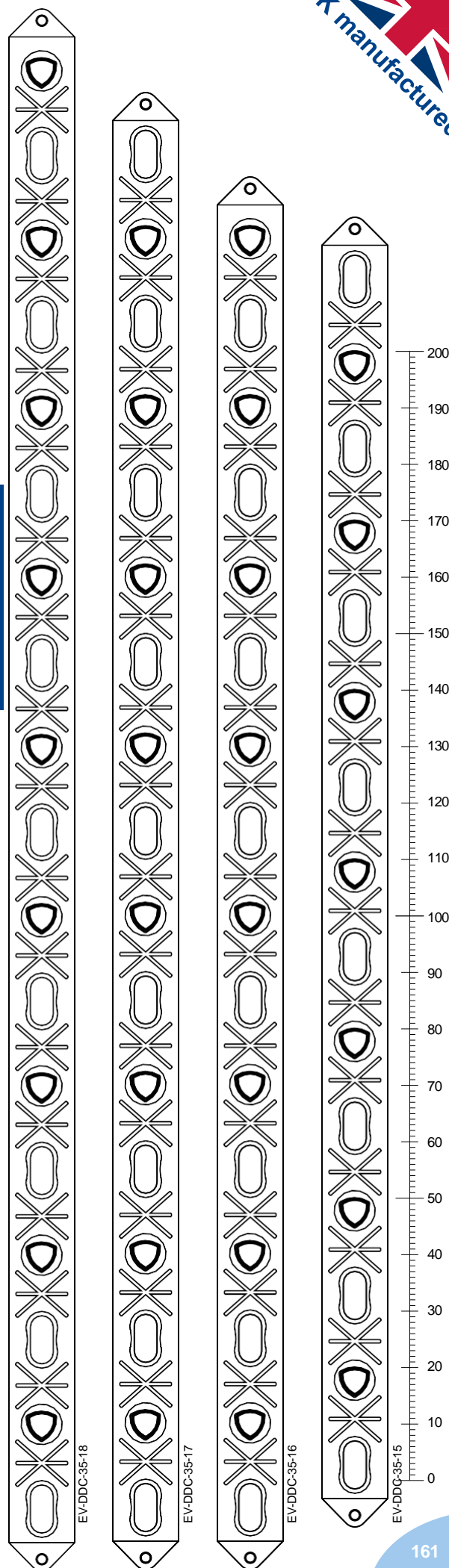

Evolox[®] Supracondylar

Evolox[®] Supracondylar Osteotomy

The same profile and footprint as the standard plate but benefitting from Evolox[®] Poly-Axial Locking holes for greater placement. This ensures screws do not work their way loose and increases pull out resistance. Using the combination of Locking or Cortical Screws can aid procedure. Available in 2.0/2.4/2.7/3.5/3.5mm long.

Cortical and Locking Screws can be used. There is also room to use a 2.2/3.0/4.0mm Cancellous Screws in extreme case where other sizes have failed.

Order Code	Description	RRP
EV-SCO-35-135-R	3.5mm Evolox [®] Locking Supracondylar Osteotomy Plate Right	£131.30
EV-SCO-35-135-L	3.5mm Evolox [®] Locking Supracondylar Osteotomy Plate Left	£131.30
EV-SCO-35-86-R	3.5mm Evolox [®] Locking Supracondylar Osteotomy Plate Right	£113.40
EV-SCO-35-86-L	3.5mm Evolox [®] Locking Supracondylar Osteotomy Plate Left	£113.40
EV-SCO-27-69-R	2.7mm Evolox [®] Locking Supracondylar Osteotomy Plate Right	£78.80
EV-SCO-27-69-L	2.7mm Evolox [®] Locking Supracondylar Osteotomy Plate Left	£78.80
EV-SCO-24-62-R	2.4mm Evolox [®] Locking Supracondylar Osteotomy Plate Right	£73.50
EV-SCO-24-62-L	2.4mm Evolox [®] Locking Supracondylar Osteotomy Plate Left	£73.50
LPL-SCO-20-50-R	2.0mm Locking Supracondylar Osteotomy Plate Right	£63.00
LPL-SCO-20-50-L	2.0mm Locking Supracondylar Osteotomy Plate Left	£63.00

Evolox[®] Partial Carpal Arthrodesis

Specialist plates that have become a popular bespoke plate. All holes are locking, with single compression.

Order Code	Description	RRP
EV-PCA-24-27	2.4/2.7mm Evolox [®] Partial Carpal Arthrodesis 51mm	£63.00
EV-PCA-27-35	2.7/3.5mm Evolox [®] Partial Carpal Arthrodesis 65mm	£73.50

3.5mm Evolox[®] Distal Radius T-Plate

Combining Locking/Evolox[®] technology with these plates has always been a recommendation from surgeons.

Order Code	Description	RRP
EV-DRP-35-07-T	3.5mm Evolox [®] Distal Radius T-Plate 77mm Long 7 Hole	£57.80
EV-DRP-35-08-T	3.5mm Evolox [®] Distal Radius T-Plate 77mm Long 8 Hole	£57.80

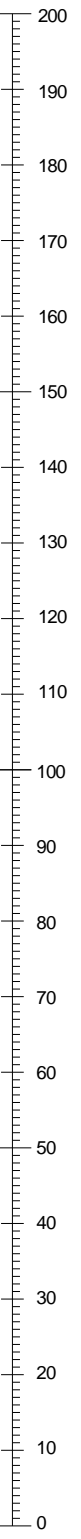
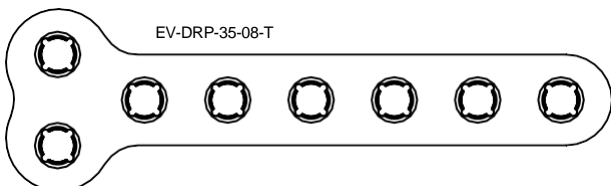
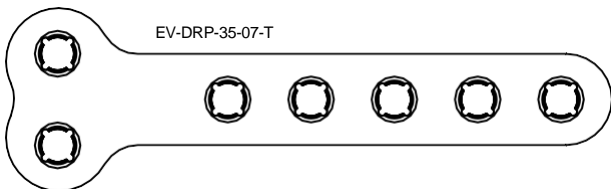
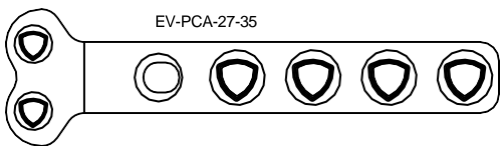
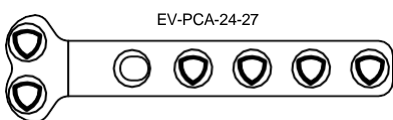
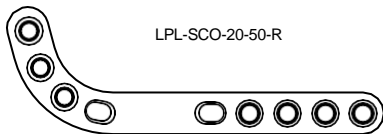
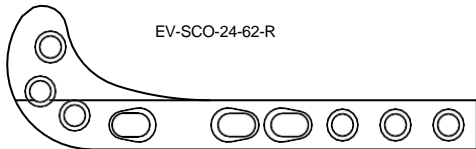
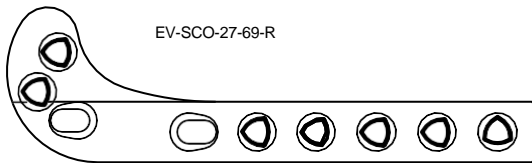
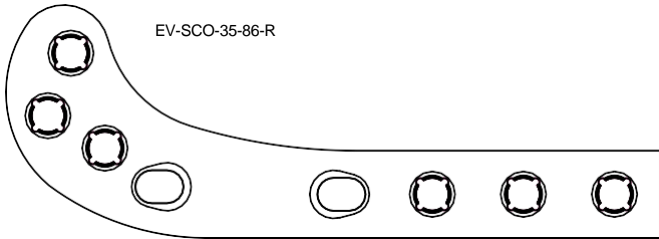
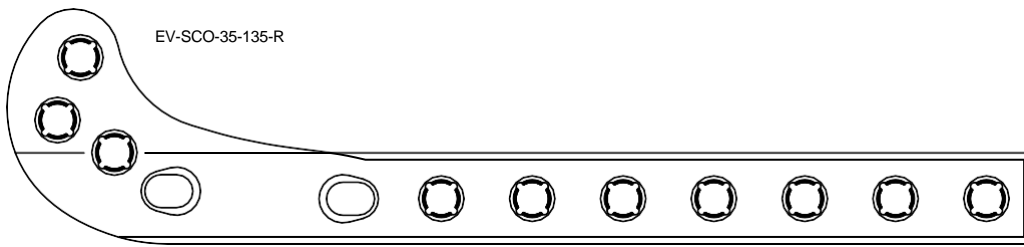



RP (Rory Paton) TPLO Plate

Exclusive Collaboration with N2 and Rory Paton BVSc CertAVP MRCVS, founder of VetSOS Education Ltd and the famous VPOP.

N2 are delighted to announce the release of their new TPLO plate to complement their pre-existing comprehensive range. Extensively designed by surgeons for surgeons.

Anatomically pre-contoured to conform to the natural shape of a tibia AFTER a TPLO for each individual size.

- The plate uses regular cortical and locking screws - no need to change inventory, just order the plate you need.
- DUAL compression is achieved. The first distal compression screw compresses the cranial part of the osteotomy, parallel to your reduction pin. The second proximal cortical screw compresses radially to the centre of rotation.
- All locking screws are POLYAXIAL- to avoid the joint and the temporary reduction pin.
- Diverge/converge the screws as you wish for optional bone engagement and pull out resistance. Maximise the proximal transcortical distance by aiming for the easily palpable fibular head landmark and avoid the joint.
- Uniquely, offset compression can be achieved to preserve the periosteal vascularity with the optional dedicated locking guide. The osteotomy compression can be achieved without pulling the plate to the bone.
- Digital templating and virtual surgical planning is exclusively available to download at vpop-pro.com. Plan with absolute precision on your iPhone, iPad, Windows 10 or MacOS device.
- Temporarily stabilize your plate with Fragment forceps or a K-wire. The K-wire will not jam- it simply glides through a radially aligned slot DURING the radial compression.
- Use the helpful laser-marked ruler on the leading edge to facilitate measurements for D1,2 and rotation. Laser marked numbering of screw holes for drilling and filling! Helpful for when you are first starting out.

Code	Description	Cost
LPL-RP-TPLO-20L	2.0mm RP TPLO Plate Left hand	£80.00
LPL-RP-TPLO-20R	2.0mm RP TPLO Plate Right hand	£80.00
EV-RP-TPLO-24L	Evolox® 2.4mm RP TPLO Plate Left hand	£85.00
EV-RP-TPLO-24R	Evolox® 2.4mm RP TPLO Plate Right hand	£85.00
EV-RP-TPLO-27L	Evolox® 2.7mm RP TPLO Plate Left hand	£90.00
EV-RP-TPLO-27R	Evolox® 2.7mm RP TPLO Plate Right hand	£90.00
EV-RP-TPLO-35LS	Evolox® 3.5mm Short RP TPLO Plate Left hand	£95.00
EV-RP-TPLO-35RS	Evolox® 3.5mm Short RP TPLO Plate Right hand	£95.00
EV-RP-TPLO-35L	Evolox® 3.5mm RP TPLO Plate Left hand	£100.00
EV-RP-TPLO-35R	Evolox® 3.5mm RP TPLO Plate Right hand	£100.00

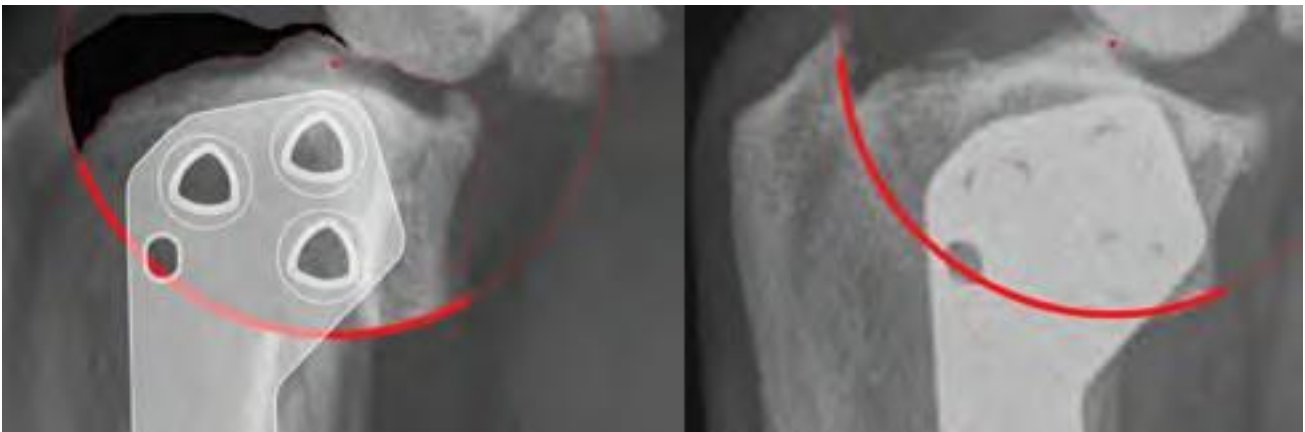
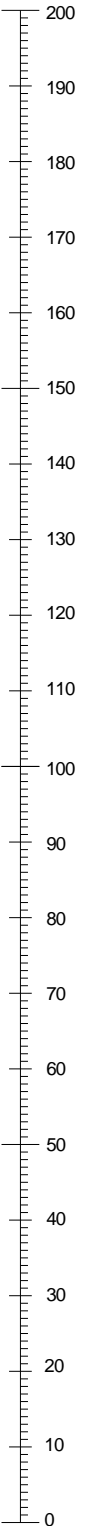
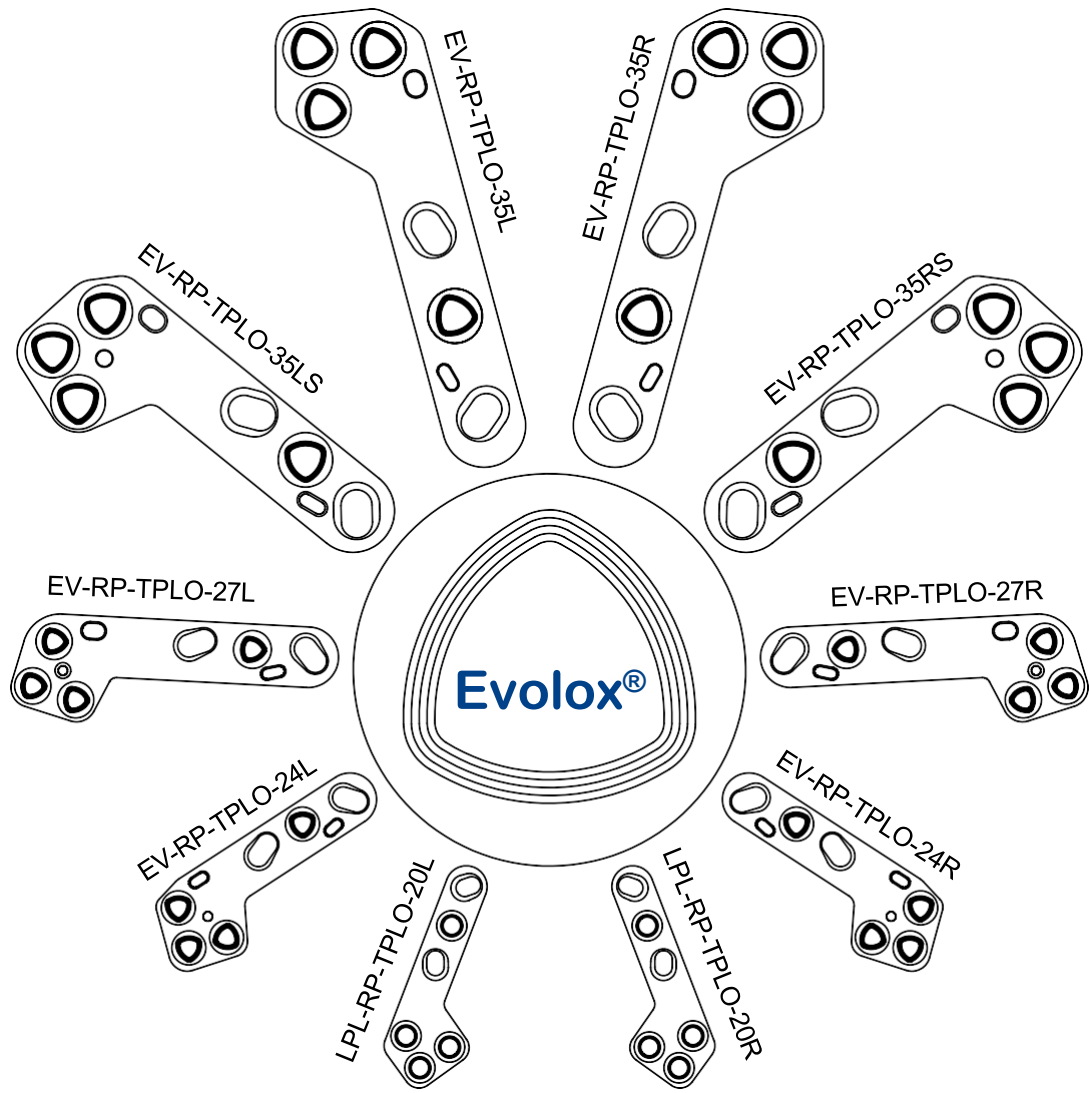

Pre-operative planning

8 weeks post-operative

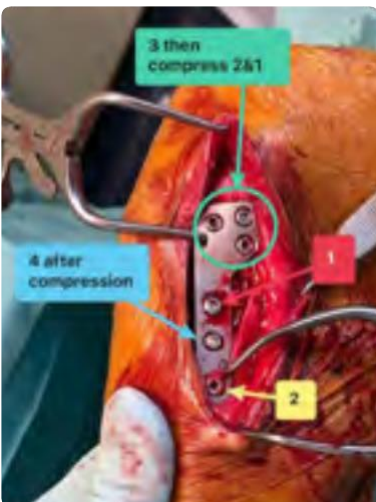
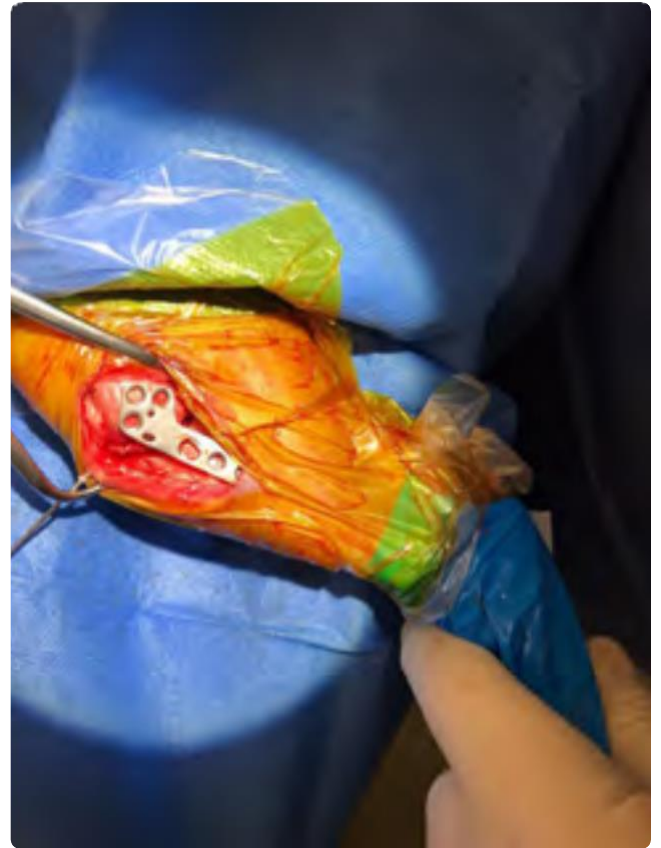
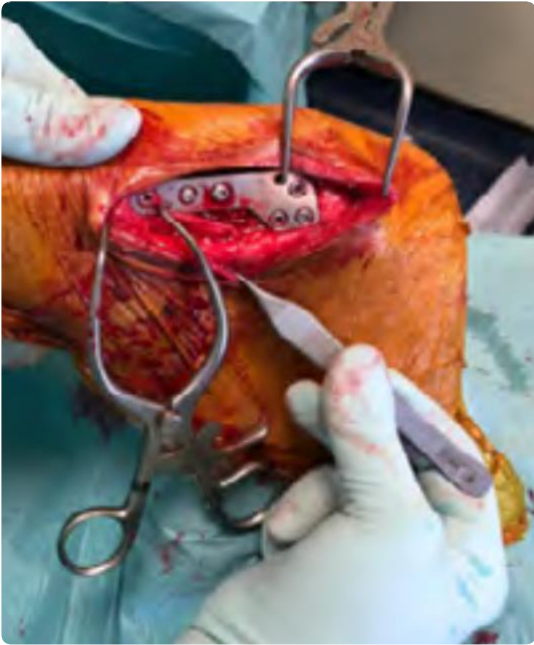

TTA

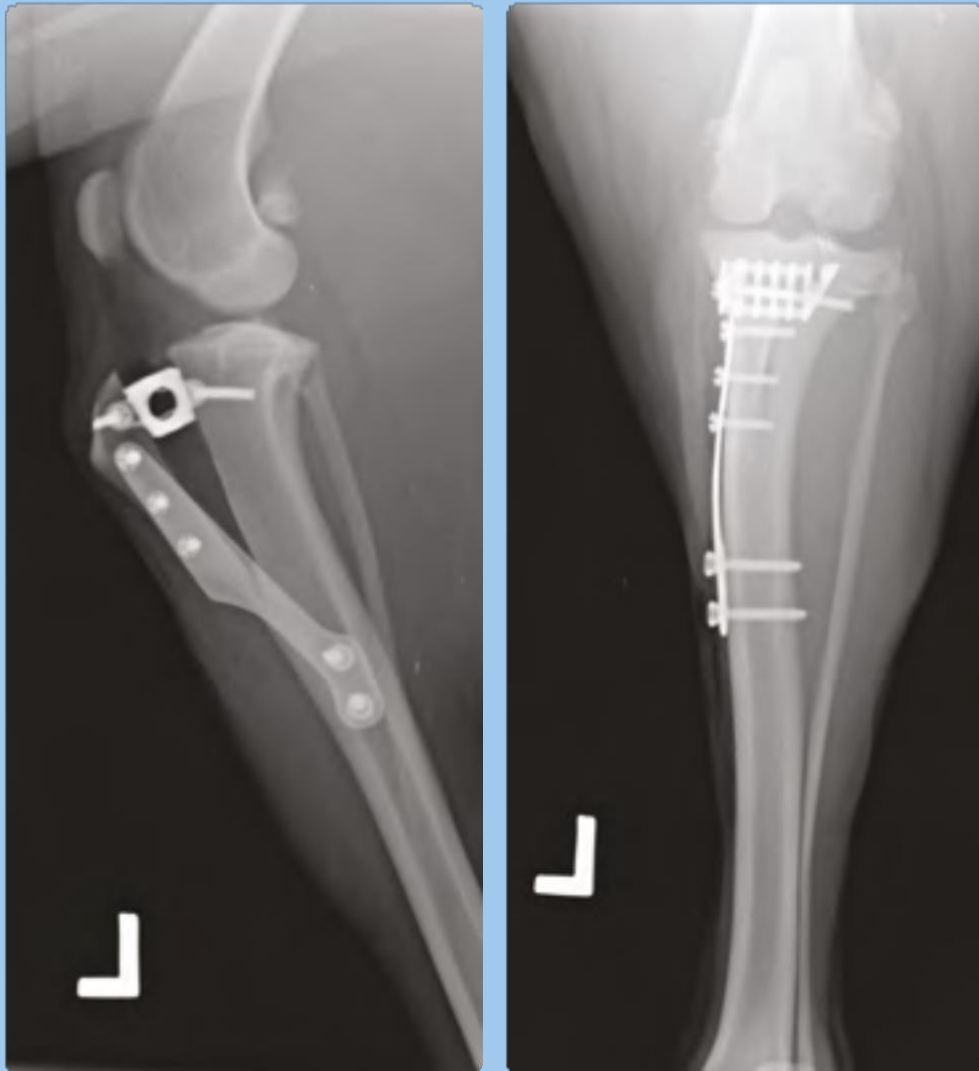

Tibial Tuberosity Advancement

Instead of altering the slope of the tibial plateau the TTA alters the point of insertion of the patella tendon. Only part of the bone (the tibial tuberosity) is cut, “advanced” by means of a titanium cage, and secured with a plate and screws or forks. This advancement acts to “tighten-up” the joint, alleviating the instability. A theoretical advantage of this procedure is its less-invasive nature — there is less surgical dissection of the soft tissues and the tibia is not cut within the weight-bearing axis. TTA cages have been proven to work just as effectively with a forkless plate and using standard cortical screws.

Manufactured using Implant grade Titanium Alloy.

Tibial Tuberosity Advancement - Titanium Alloy (Ti)

TTA Cages

N2 ITEM NO	Description	Colour	RRP
TTC-3/10	TTA Cage	Gold	£50.40
TTC-3/11	TTA Cage	Gold	£50.40
TTC-3/13	TTA Cage	Gold	£50.40
TTC-3/16	TTA Cage	Gold	£50.40
TTC-3/19	TTA Cage	Gold	£50.40
TTC-4.5/10	TTA Cage	Green	£50.40
TTC-4.5/13	TTA Cage	Green	£50.40
TTC-4.5/16	TTA Cage	Green	£50.40
TTC-4.5/19	TTA Cage	Green	£50.40
TTC-6/13	TTA Cage	Blue	£50.40
TTC-6/16	TTA Cage	Blue	£50.40
TTC-6/19	TTA Cage	Blue	£50.40
TTC-6/22	TTA Cage	Blue	£50.40
TTC-7.5/13	TTA Cage	Brown	£57.80
TTC-7.5/16	TTA Cage	Brown	£57.80
TTC-7.5/19	TTA Cage	Brown	£57.80
TTC-7.5/22	TTA Cage	Brown	£57.80
TTC-9/16	TTA Cage	Blue	£57.80
TTC-9/19	TTA Cage	Blue	£57.80
TTC-9/22	TTA Cage	Blue	£57.80
TTC-9/25	TTA Cage	Blue	£57.80
TTC-10.5/19	TTA Cage	Dark purple	£57.80
TTC-10.5/22	TTA Cage	Dark purple	£57.80
TTC-10.5/25	TTA Cage	Dark purple	£57.80
TTC-12/22	TTA Cage	Light purple	£63.00
TTC-12/25	TTA Cage	Light purple	£63.00
TTC-12/28	TTA Cage	Light purple	£63.00
TTC-13.5/22	TTA Cage	Green	£63.00
TTC-13.5/25	TTA Cage	Green	£63.00
TTC-13.5/28	TTA Cage	Green	£63.00
TTC-15/22	TTA Cage	Brown	£63.00
TTC-15/25	TTA Cage	Brown	£63.00
TTC-15/28	TTA Cage	Brown	£63.00
TTC-15/31	TTA Cage	Brown	£63.00



TTA Cuttable Cage

Our cages have four thin bars to cut instead of 2 thick bars that others use. This makes ours easier to cut with much less force required to cut through the cage, reducing the chance of cage parts flying across the theatre during the op.

Cutttable cages work in the same way as standard cages however as the name implies, they are cut to size. This allows the surgeon to be more precise in the length options available to them but also vastly reduces the inventory they need to carry.



N2 ITEM NO	Description	Colour	RRP
TTCC-3/19	TTA Cuttable Cage	Gold	£52.50
TTCC-4.5/16	TTA Cuttable Cage	Green	£52.50
TTCC-6/22	TTA Cuttable Cage	Blue	£55.70
TTCC-7.5/23	TTA Cuttable Cage	Brown	£55.70
TTCC-9/25	TTA Cuttable Cage	Blue	£55.70
TTCC-10.5/25	TTA Cuttable Cage	Dark purple	£55.70
TTCC-12/28	TTA Cuttable Cage	Light purple	£55.70
TTCC-13.5/28	TTA Cuttable Cage	Green	£55.70
TTCC-15/31	TTA Cuttable Cage	Brown	£55.70
TTCC-16/34	TTA Cuttable Cage	Green	£55.70



TTA Spacers

Order Code	Description	RRP
TTS-2-S	2mm Titanium Spacer 6mm Diameter	£5.30
TTS-4-S	4mm Titanium Spacer 6mm Diameter	£5.30
TTS-6-S	6mm Titanium Spacer 6mm Diameter	£5.30
TTS-2-L	2mm Titanium Spacer 13mm Diameter	£5.30
TTS-4-L	4mm Titanium Spacer 13mm Diameter	£5.30
TTS-6-L	6mm Titanium Spacer 13mm Diameter	£5.30

TTA Forks

Order Code	Description	RRP
TTF-2P	TTA Fork 2 Prong	£20.40
TTF-3P	TTA Fork 3 Prong	£22.10
TTF-4P	TTA Fork 4 Prong	£23.80
TTF-5P	TTA Fork 5 Prong	£25.50
TTF-6P	TTA Fork 6 Prong	£27.20
TTF-7P	TTA Fork 7 Prong	£28.90
TTF-8P	TTA Fork 8 Prong	£30.60

TTA Plates

Order Code	Description	RRP
TTP-2H	TTA Plate 2 Hole	£17.00
TTP-3H	TTA Plate 3 Hole	£18.70
TTP-4H	TTA Plate 4 Hole	£20.40
TTP-5H	TTA Plate 5 Hole	£22.10
TTP-6H	TTA Plate 6 Hole	£23.80
TTP-7H	TTA Plate 7 Hole	£25.50
TTP-8H	TTA Plate 8 Hole	£27.20

For Titanium Screws please see page 27 & 28

TTA Forkless Plates

Order Code	Description	RRP
TTP-X2-FL	TTA Forkless Plate	£17.00
TTP-X3-FL	TTA Forkless Plate	£18.70
TTP-X4-FL	TTA Forkless Plate	£20.40
TTP-X5-FL	TTA Forkless Plate	£22.10
TTP-X6-FL	TTA Forkless Plate	£23.80
TTP-X7-FL	TTA Forkless Plate	£25.50
TTP-X8-FL	TTA Forkless Plate	£27.20

For TTA instrumentation please see our Instrument Catalogue pages 11 & 12

Order Code	Description	RRP
WAS-24-TTA	2.4 Titanium TTA Washer ID 2.7 OD 5.0 W 1.0	£5.00

TTA Plates

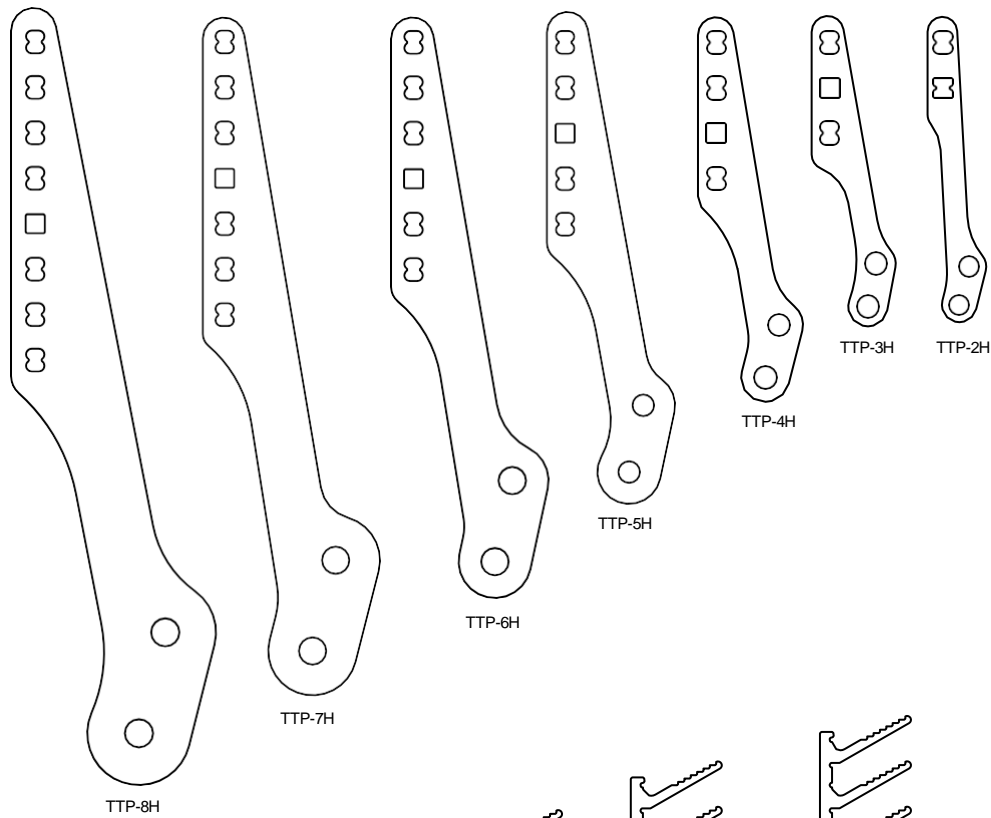

TTA Forks

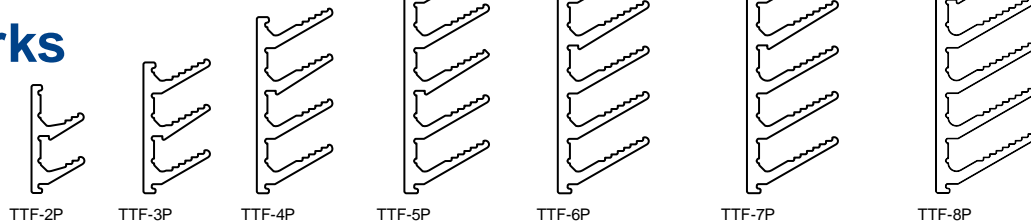

TTP-X8-FL TTP-X7-FL TTP-X6-FL TTP-X5-FL TTP-X4-FL TTP-X3-FL TTP-X2-FL

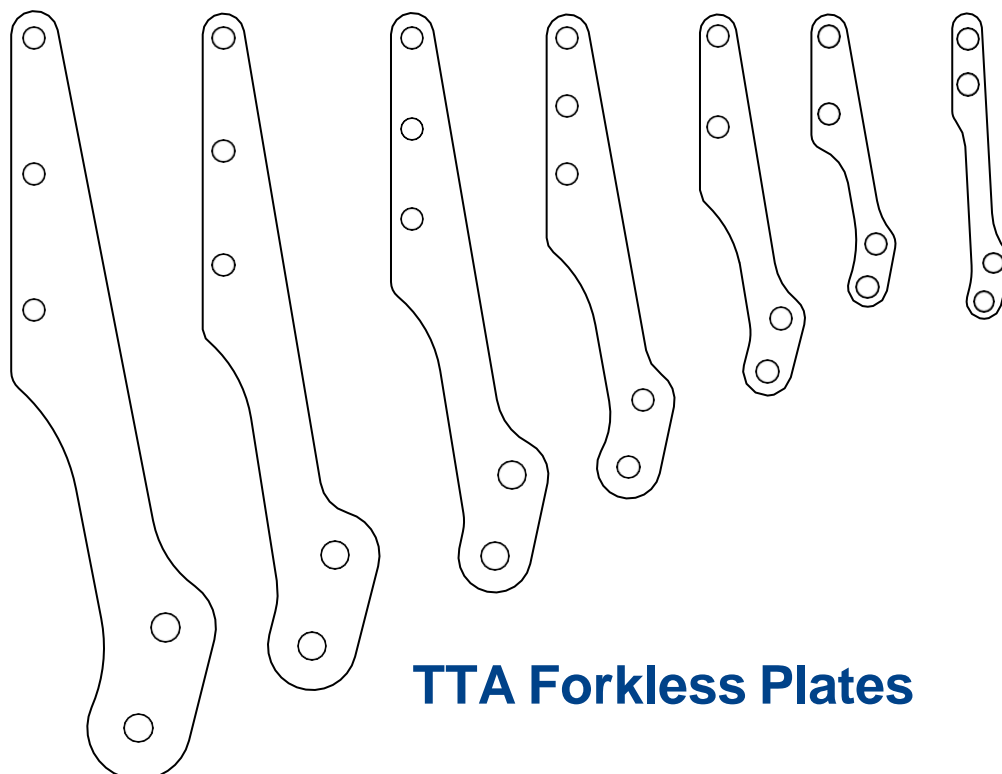

TTA Forkless Plates

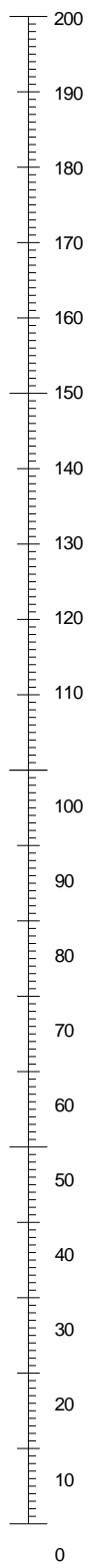



Choices and Preferential Options

We can produce all of our Trauma Plate range to have any of the three finish options.

Satin Finish

Starting to be very popular and desirable for the following reasons:

- lack of annoying light reflection during surgery.
- Creates a uniform surface layer of compressive stress, which acts to combat stress cracks and corrosion, therefore, increasing the life of implant.
- Greater ultrasound reflection.
- Cleaner part, free from residues with a low CFU (microorganism) count, resulting in easier autoclave sterilisation.

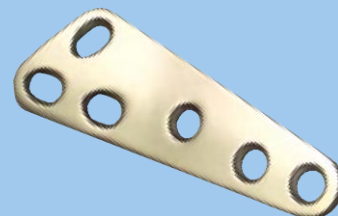

Titanium

- Blue Anodised
- Extreme light weight (around 45% of Stainless 316LVM),
- Biocompatible, (Limited Rejection Rates, non-toxic AND not rejected by the body)
- MRI Compatible, (non-ferromagnetic, which means it can be safely examined)
- Higher Fatigue Life,
- Excellent corrosion resistance.
- Titanium Anodising also produces anti-galling properties.

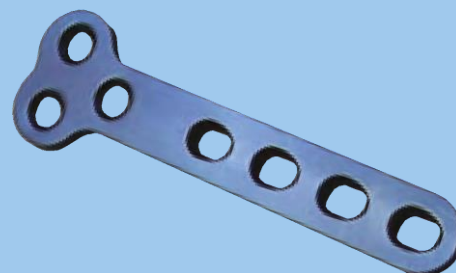

Osseointegration is a unique phenomenon where your body's natural bone and tissue actually bond to the artificial implant. This firmly anchors the titanium dental or medical implant into place. Titanium is one of the only metals that allows for this integration.

Titanium vs Stainless Steel

- Quality and Choice

Our manufacturing facility is independently audited and meets the Quality management system of ISO 134585:2016 criteria for medical devices and regulatory requirements.

Stainless Steel has long been the economical and accepted material for most Implants in the Veterinary and Human Orthopaedic sector. There is no 'Right' or 'Wrong' choices of either Titanium or Stainless and the surgeon will ultimately choose the best product to load bearing, infections risks, cost and procedure.

Some keys points.

Stainless Steel

All our Implants are made with fully compliant and certified materials (ISO 5832-1 ASTM F138 for screws and ASTM F139 for plates to the latest ISO approved Human raw materials.

Benefits to the Surgeon

- High tensile strength
- High fatigue strength
- Excellent micro cleanliness
- Reduced Impurities
- Excellent structural homogeneity
- High surface finish

Our 316LVM Stainless Steel (conforming to ISO 5832-1) has very good resistance in physiological environments to:

- General and intergranular corrosion due to high purity and low ferrite content.
- Pitting and crevice corrosion due to the high molybdenum content.

Arthrodesis/Kirschner Wires(K-Wires) and Pins are only made from Extra Hard (XH) material (1400-Nmm²) which is some 50%+ harder than standard screw products. This ensures the wire has increased stiffness, reducing deformation during placement which in turn reduces thermal necrosis. Using the wrong materials increases the risk of necrosis, blunt points and product breakage.

Titanium CP/ Titanium Alloy

There are many grades of Titanium used in the Veterinary market, more worryingly this is a growing market for unscrupulous suppliers of sub standard raw materials. We only use medical grade which conforms to the strict Human grade ISO 5832-3 titanium Alloy.

Titanium is around 45% the weight of Stainless 316LVM meaning large plates are much lighter and has the following benefits

- Extremely biocompatible leading to low rejection rates
- MRI compatible meaning it can be safely examined
- Excellent corrosion resistance
- Higher Fatigue Life
- Anodising produces anti-galling properties
- Osseointegration

We have a range of popular plates manufactured in Titanium for specific procedures. We only recommend using Titanium Screws with all our Titanium Plates due to clinical concerns over galvanic corrosion.

Your current supplier/agent should be more than happy to supply you with a certificate of conformity (CFC) telling you country of manufactured origin, material specification and their quality credentials. We have manufacturing professionals who are happy to test and perform appraisals if you have any concerns.



Index

Page

1.5mm Cortical Screws (1.5 Hex)	19
1.5mm Locking Drill Guide	124
1.5mm Mini Self Compression Plate	56
2.0/2.7/3.5/4.5mm Buttress Bridge Plate (Biological Healing Plate)	70
2.0mm Broad Mini Compression Plate	58
2.0mm Cortical Screws (Various Drives)	19
2.0mm Distal Plates	80
2.0mm Fine Threaded Fragment Pins	48
2.0mm Limited Contact Plate	90
2.0mm Locking Drill Guide	124
2.0mm Locking Plate	115
2.0mm Locking Plug	126
2.0mm Locking T-Plates	115
2.0mm Mini Plate Straight Tubular	74
2.0mm Mini Self Compression Plate	56
2.0mm Mono-Axial Locking Compression Locking Plate	116
2.0mm Round Hole Plate	100
2.0mm YY Plates	115
2.4mm Locking Plate	118
2.4mm Evolox® Biological Healing Plates	146
2.4mm Evolox® Cuttable & Cuttable Malleable Plates	134
2.4mm Evolox® Poly-Axial Compression Locking Plate	144
2.4mm - Evolox® TPLO Version 2	156
2.4mm Limited Contact Plate	90
2.4mm Locking Drill Guide	124
2.4mm Mini Self Compression Plate	58
2.4mm Self Tapping Cortical Screws (Various Drives)	20
2.7mm Locking Plate	120
2.7mm Cortical Screws (Various Drives)	21
2.7mm Distal Plates	80
2.7mm Evolox® Osteosynthesis Plates	134
2.7mm Evolox® Poly-Axial Compression Locking Plate	144
2.7mm Heavy Duty Round Hole Plate	102
2.7mm Limited Contact Plate	92
2.7mm Locking Drill Guide	124
2.7mm Locking Plug	126
2.7mm Mini Self Compression Plate Thick	60
2.7mm Mini Self Compression Plate Thin	60
2.7mm Quarter Tubular	74
2.7mm Reconstruction Plates	76
2.7mm Round Hole Plate	100

Index

Page

3.5mm Broad Buttress Bridge Plate (Biological Healing Plate)	72
3.5mm Broad Limited Contact Plate	96
3.5mm Cortical Screws (Various Drives)	22
3.5mm Evolox® Biological Healing Plates	146
3.5mm Evolox® Broad Plates	140
3.5mm Evolox® DDC	161
3.5mm Evolox® Osteosynthesis Plates	136
3.5mm - Evolox® TPLO Small	157
3.5mm Heavy Duty Round Hole Plate	102
3.5mm Limited Contact Plate	94
3.5mm Locking Drill Guide	124
3.5mm Locking Plate	122
3.5mm Locking Plug	126
3.5mm One Third Tubular	74
3.5mm PCL Evolox® (Poly-axial Compression Locking Plate)	142
3.5mm Reconstruction Plates	76
3.5mm Round Hole Plate	100
3.5mm Self Compression Plate Straight Broad	64
3.5mm Self Compression Plate Straight Narrow	62
3.5 T-Plates Round Hole	80
4.5mm Cortical Screws	23
4.5mm Self Compression Plate Straight Broad	68
4.5mm Self Compression Plate Straight Narrow	66
Acetabular Plates	80
Antebrachial Plates - Mono-Axial Locking	116
Anti Skid Drill Bit	36
Arthrodesis Plates - Pancarpal DCP Style	88
Arthrodesis Plates - Pancarpal Round Holes	88
Biological Healing Plates - 2.4mm Evolox®	146
Biological Healing Plates - 3.5mm Evolox®	146
Broad Buttress Bridge Plate (Biological Healing Plate) - 3.5mm	72
Broad Cuttable Plates	78
Broad Limited Contact Plate - 3.5mm	96
Broad Mini Compression Plate - 2.0mm	58
Broad Plates - 3.5mm Evolox®	140
Buttress Bridge Plate (Biological Healing Plate) - 2.0/2.7/3.5/4.5mm	70
Cage - TTA	168
Cancellous Screws	24
Canine Cranial Pantarsal Arthrodesis Plate	86
Cannulated Drill Bit	36
Cannulated Locking Plugs	17, 126



Index

Page

Circular Cuttable Locking Plate	115, 148
Compression Plates	56-69
Cortical Screws (1.5 Hex) - 1.5mm	19
Cortical Screws - 4.5mm	23
Cortical screws	18, 19,20,21,22,23
Cortical Screws Cruciform Head	18
Cortical Screws Hex Head	18
Cortical Screws Torx/Star Head	18
Cortical Screws - Titanium	28
Cortical Screws (Various Drives) - 2.0mm	19
Cortical Screws (Various Drives) - 2.7mm	21
Cortical Screws (Various Drives) - 3.5mm	22
Cross-Head Screwdriver 2.4mm	39
Circular Cuttable Locking Plates	148
Cuttable Cage - TTA	168
Cuttable & Cuttable Malleable Plates - 2.4mm Evolox®	134
Cuttable Malleable Plates	78
Cuttable Plates	78
Distal Plates - 2.0mm	80
Distal Plates - 2.7mm	80
Drill Bit - Anti Skid	36
Drill Bit - Cannulated	36
Drill Bits - Evodurance®	35
Drill Bits - Standard	37
Drill Stop Set	36
Drill Storage Box	40
Dual Direction Compression (DDC) Evolox® Locking Plates	161
Evodurance® Drill Bits	35
Evolox® 2.4mm Closing Wedge TPLO Plates	156
Evolox® 2.4mm TPLO Version 2	156
Evolox® 3.5mm Distal Radius T-Plate	162
Evolox® 3.5mm TPLO Small	157
Evolox® 3.5mm TPLO Heavy	157
Evolox® Canine Cranial Pantarsal Arthrodesis Plate	152
Evolox® DDC - 3.5mm	161
Evolox® Feline Pantarsal Plate Cranial Position	152
Evolox® GEN2 Acetabular	146
Evolox® Gen-2 Hybrid T-Plates	149
Evolox® Partial Carpal Arthrodesis	162
Evolox® Pancarpal Arthrodesis Plates Special All Locking (PAL)	150
Evolox® Poly-Axial Compression Locking Plate - 2.4mm	144



Index

Page

Evolox® Poly-Axial Compression Locking Plate - 2.7mm	144
Evolox® Supracondylar Osteotomy Plates	162
Evolox® TPLO	154
Evolox® TPLO Closing Wedge	158
Evolox® TPLO Delta 'Style' Plates	160
Evolox® TPLO Mono-Axial Proximal Hole	158
Evolox® TPLO Poly-Axial Proximal Hole	158
Evolox® YY Plates	148
Extra Long Kirschner Wires	47
Feline Pantarsal Plate Cranial Position	86
Fine Threaded Fragment Pins - 2.0mm	48
Forkless Plates - TTA	170
Forks - TTA	170
Fully Threaded Kirschner Wires Trocar / Trocar	48
GEN2 Acetabular - Evolox®	146
Handles - Screw Driver Premium AO & Dental Fit Quick Release	40
Headless Lag Screws	32
Head Screwdrivers - Torx/Star	38
Hex Drive Locking Screws	15
Hex Head Screwdrivers	38
Holding Sleeves - Screw	39
H-Plates	80
Hybrid Locking Screws	16
Hybrid T-Plates	82
Hybrid T-Plates - Evolox® Gen-2	149
Intertarsal Arthrodesis Plates	98
IOHC (Incomplete ossification of the humeral condyle)	30, 31
Kirschner Wire (Bayonet / Round)	47
Kirschner Wires (K-wires), Steinmann Pins Denham pins and guide wires	45
Kirschner Wire (Trocar both ends)	47
Limited Contact Plate - 2.0mm	90
Limited Contact Plate - 2.4mm	90
Limited Contact Plate - 2.7mm	92
Limited Contact Plate - 3.5mm	94
Locking Drill Guide - 2.0mm	124
Locking Drill Guide - 1.5mm	124
Locking Drill Guide - 2.0mm	124
Locking Drill Guide - 2.4mm	124
Locking Drill Guide - 2.7mm	124
Locking Drill Guide - 3.5mm	124
Locking Pancarpal Arthrodesis	88



Index

Page

Locking Plate - 2.0mm	115
Locking Plate - 2.4mm	118
Locking Plate - 2.7mm	120
Locking Plate - 3.5mm	122
Locking Plates - Circular Cuttable	115, 148
Locking Plug - 2.0mm	126
Locking Plug - 2.7mm	126
Locking Plug - 3.5mm	126
Locking Plugs	16
Locking Plugs - Cannulated	126
Locking Screws	13, 14, 15, 16
Locking Screws - Hex Drive	15
Locking Screws - Hybrid	16
Locking Screws - Torx Drive	14
Locking T-Plates - 2.0mm	115
Mini Plate Straight Tubular - 2.0mm	74
Mini Self Compression Plate - 1.5mm	56
Mini Self Compression Plate - 2.0mm	56
Mini Self Compression Plate - 2.4mm	58
Mini Self Compression Plate Thick - 2.7mm	60
Mini Self Compression Plate Thin - 2.7mm	60
Mono-Axial Locking Antebrachial Plates	116
Mono-Axial Locking Compression Locking Plate - 2.0mm	140
Negative Threaded Ellis Pins Short Fine End Thread	49
Negative Threaded Pins Cortical End Thread	48
One Third Tubular - 3.5mm	74
Osteosynthesis Plates - 2.7mm Evolox®	134
Osteosynthesis Plates - 3.5mm Evolox®	136
Pancarpal and Pantarsal	84-88
Pancarpal and Pantarsal Evolox®	150
Pancarpal Arthrodesis - Locking	88
Pancarpal Arthrodesis Plates DCP Style	88
Pancarpal Arthrodesis Plates Round Holes	88
Pantarsal and Pancarpal	84-88
Pantarsal Arthrodesis Plates	84
Pantarsal Plate - Feline Cranial Position	86
Partial Carpal Arthrodesis Plate	88
PCL Evolox® (Poly-axial Compression Locking Plate) - 3.5mm	142
Pins - Kirschner Wires (K-wires), Steinmann Pins, Denham pins and guide wires	45
Pins - Negative Threaded Cortical End Thread	48
Pins - Negative Threaded Ellis Short Fine End Thread	49

Index

Page

Pins - Positive Threaded Cancellous End Thread	50
Pins - Positive Threaded Cancellous Mid Thread	50
Pins - Positive Threaded Cortical End Thread	49
Pins - Positive Threaded Cortical Mid Thread	50
Pins - Suture Anchor	26
Pin - Steinman Intra-Medullary Threaded Trocar / Plain Trocar Tips	46
Pin - Steinman Intra-Medullary Trocar Tips	46
Plate - Canine Cranial Pantarsal Arthrodesis	86
Plate - Feline Pantarsal Cranial Position	86
Plate - Partial Carpal Arthrodesis	86
Plates - Acetabular	80
Plates - Broad Cuttable	78
Plates - Compression	56-69
Plates - Cuttable	78
Plates - Cuttable Malleable	78
Plates - Intertarsal Arthrodesis	98
Plates - Pantarsal Arthrodesis	84
Plates - Supracondylar Osteotomy	98
Plates - Supracondylar Osteotomy	156
Plates - Supracondylar Osteotomy (Distal Femur)	98
Plates - Titanium	108
Plates - TTA	164
Plugs - Locking	16
Positive Threaded Pins Cancellous End Thread	50
Positive Threaded Pins Cancellous Mid Thread	50
Positive Threaded Pins Cortical End Thread	49
Positive Threaded Pins Cortical Mid Thread	50
Premium Screwdrivers Tips	39
Quarter Tubular - 2.7mm	74
Quick release Screwdriver Tips	38
Quick Release - Taps AO / Dental Fit	41
Reconstruction Plates - 2.7mm	76
Reconstruction Plates - 3.5mm	76
Round Hole Plate - 2.0mm	100
Round Hole Plate - 2.7mm	100
Round Hole Plate - 2.7mm Heavy Duty	102
Round Hole Plate - 3.5mm	100
Round Hole Plate - 3.5mm Heavy Duty	102
RP (Rory Paton) TPLO Plate	164, 165
Screwdriver 2.4mm Cross-Head	39
Screw Driver Handles - Premium AO & Dental Fit Quick Release	40



Index	Page
Screwdrivers	38,39,40
Screwdrivers - Hex Head	38
Screwdrivers - Torx/Star Head	38
Screwdrivers - Sherman	40
Screwdrivers Tips - Premium	39
Screwdriver Tips - Quick release	38
Screw Holding Sleeves	39
Screws - Cancellous	24
Screws Cortical	18, 19,20,21,22,23
Screws - Headless Lag	32
Screws Locking	14,15,16
Screws - Suture Anchor	25
Screws - Titanium	27
Screws - TTA (Cruciform Drive) Low profile	29
Self Compression Plate Straight Broad - 3.5mm	64
Self Compression Plate Straight Broad - 4.5mm	68
Self Compression Plate Straight Narrow - 3.5mm	62
Self Compression Plate Straight Narrow - 4.5mm	66
Self Tapping Cortical Screws (Various Drives) - 2.4mm	20
Sherman Screwdrivers	40
Spacers - TTA	170
Stabilising pin with olive	49
Standard Drill Bits	37
Steinman Intra-Medullary Pin Threaded Trocar / Plain Trocar Tips	46
Steinman Intra-Medullary Pin Trocar Tips	46
Stop Set - Drill	36
Storage Box - Drill	40
Supracondylar Osteotomy (Distal Femur) Plates	98
Supracondylar Osteotomy Plates	98
Suture Anchor Pins Self tapping)	26
Suture Anchor Screws	25
Taps Quick Release AO / Dental Fit	41
Titanium Cortical Screws	28
Titanium Pancarpal and Pantarsal Plates	110
Titanium Plates	108
Titanium Screws	279
Titanium TPLO Compression Plates	108
Titanium TPLO Delta Plates	108
Torx Drive Locking Screws	14
Torx/Star Head Screwdrivers	38
T-Plates - Hybrid	82

Index

Page

T-Plates Round Hole - 3.5	80
TPLO Compression Plates	106
TPLO Delta 'Style' Plates	104
TPLO - Evolox®	154
TPLO Evolox® Delta 'Style' Plates	160
TPLO Jig Guide Pin	49
TPLO Plate - RP (Rory Paton)	164, 165
TPLO Pre Contoured Compression Plates	106
TPLO (Slocum style)	106
TPO EQ	104
TTA Cage	168
TTA Cuttable Cage	168
TTA Forkless Plates	170
TTA Forks	170
TTA Plates	164
TTA Screws (Cruciform Drive) Low profile	29
TTA Spacers	170
Universal Suture Screw Insertion Driver	25
Wire - Fully Threaded Kirschner Trocar / Trocar	48
Wire - Kirschner Extra Long	47
Wire - Kirschner (Bayonet / Round)	47
Wire - Kirschner (Trocar both ends)	47
YY Plates - 2.0mm	115
YY Plates - Evolox®	148

N2 (UK) Ltd



Veterinary Supplies

N2 (UK) Ltd
N2
Veterinary Supplies



VETERINARY
Instrument
Catalogue

Distributor for the Czech and Slovak Republics
MEDCOMPLEX s.r.o.



Ⓞ <http://www.medcomplex.cz>
☎ +420 776 270 683
✉ info@medcomplex.cz
Masty 1, Dobruška 51801
Czech Republic - EU



**Please contact us for a copy
of our Veterinary Instrument
Catalogue**

Ⓞ <http://www.medcomplex.cz>

☎ +420 776 270 683

✉ info@medcomplex.cz

Masty 1, Dobruška 51801

Czech Republic - EU

