



SECUROS

where **imagination**
becomes
reality

SECUROS Catalog

TRUST SECUROS

Revolutionary Ideas, Unwavering Reliability, Meticulous Craftsmanship

Since 1997, SECUROS has set its corporate sights on being the veterinary profession's best resource by delivering new techniques, cutting edge surgical instrumentation and orthopedic products based on the "SECUROS Philosophy."

Innovation In-house engineers and scientists turn vision into product, with direct input from veterinarians.

Customer Service Committed staff maintains a "can-do" spirit and a "whatever it takes" approach.

Dedication Team members believe in the company, working with enthusiasm, pride and passion.

Quality Painstaking attention to detail assures the highest caliber instruments, resources and supplies.

Integrity Every employee pledges to conduct business fairly, honestly, responsibly and in compliance with demanding corporate standards.

Education Gifted orthopedic specialists lead SECUROS Orthopedic Institute labs and training year-round.



Warranty Information

SECUROS guarantees that any instrument or implant will be free of defects in materials and workmanship, when used under normal conditions for its intended purpose. In the event that an instrument or implant is defective, SECUROS will at its sole option either repair or replace the instrument or implant.

Many of the instruments manufactured by SECUROS are hand-finished by skilled craftsmen. Consequently, there may be slight variations in the dimensions of an instrument from those given in the listed specifications.

Disclaimer: The responsibility for use of SECUROS product lies entirely on the user. Incorrect handling, sterilization, or use can significantly decrease the quality or effectiveness of SECUROS product. The limitations of the product must be discussed with the patient's owner, including an emphasis on the risk of implant failure due to physical activity.



SECUROS: (877) 266-3349 www.secuross.com | MWI (800) 824-3703 www.mwivet.com



SECUROS CATALOG

Table of Contents

Orthopedic Kits

4-49

Stifle	Extracapsular Stabilization
	Tibial Tuberosity Advancement
	Tibial Plateau Leveling Osteotomy
	Meniscal Management
	Patellar Luxation
Hip	Coxofemoral Luxation Management
	Femoral Head Osteotomy
External	Linear ESF System
Internal	Pin & Wire Management
	Conventional Plate Osteosynthesis
	Locked Plate Osteosynthesis

Orthopedic Joint Management

50-169

Stifle	Extracapsular Stabilization
	Tibial Tuberosity Advancement
	Tibial Plateau Leveling Osteotomy
	Meniscal Management
	Patellar Luxation
Hip	Coxofemoral Luxation Management
	Femoral Head Osteotomy
	Pelvic Osteotomy Plates
Carpus & Tarsus	Arthrodesis



Orthopedic Trauma

170-269

External	Linear External Skeletal Fixation
Internal	Pin & Wire Management
	Conventional Plate Osteosynthesis
	Locked Plate Osteosynthesis

Orthopedic Biomaterials

270-275

- Bone Graft
- Bone Cement

Orthopedic Specialty Instruments 276-305

- Osteotomes
- Chisels
- Elevators
- Smillie Cartilage Knives
- Bone Holding Forceps
- Patella Forceps
- Bone Cutting Forceps
- Mallets
- Bone Tamps
- Rasps
- Rongeurs
- Curettes
- Gigli Saws
- Michele Trephines
- Dual Chuck Hand Chucks
- Cast Spreader
- Sterilization Containers
- Saw Blades

Surgical Instrument Care 306-321

- Warranty Information
- Cleaning & Sterilization
- Troubleshooting
- Repair Information
- ColorDot®
- Detailed Instrument Inspection
- Cleaners

Surgical Instruments 322-417

- Scalpel Handles
- Blades
- Scissors
- Forceps
- Hemostats
- Towel Clamps
- Needle Holders
- Retractors
- Miscellaneous
- Ophthalmic
- Dental
- Packs & Storage

Surgical Suture 418-429

- SECUROALLOY™ 300 Series Needles
- Absorbable & Nonabsorbable Sutures
- Swaged-on Suture Products
- Ophthalmic Codes
- Specialty Products
- Cassettes
- Needles

Index 430-432

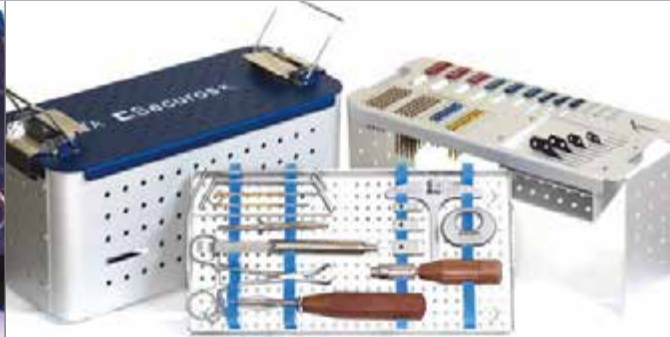

ORTHOPEDIC Implant & Instrument Kits

Joint Management	Stifle	Extracapsular Stabilization Kits	8
		Tibial Tuberosity Advancement Kits	10
		Tibial Plateau Leveling Osteotomy Kits	16
		Meniscal Management Kits	20
		Patellar Luxation Kits.....	21
Hip	Coxofemoral Luxation Management Kits.....	22	
	Femoral Head Osteotomy Kits.....	24	
Trauma	External Fixation	Linear External Skeletal Fixation Kits	26
		Pin & Wire Kits.....	30
	Internal Fixation	Conventional Plate Osteosynthesis Kits	32
		Locked Plate Osteosynthesis Kits.....	46

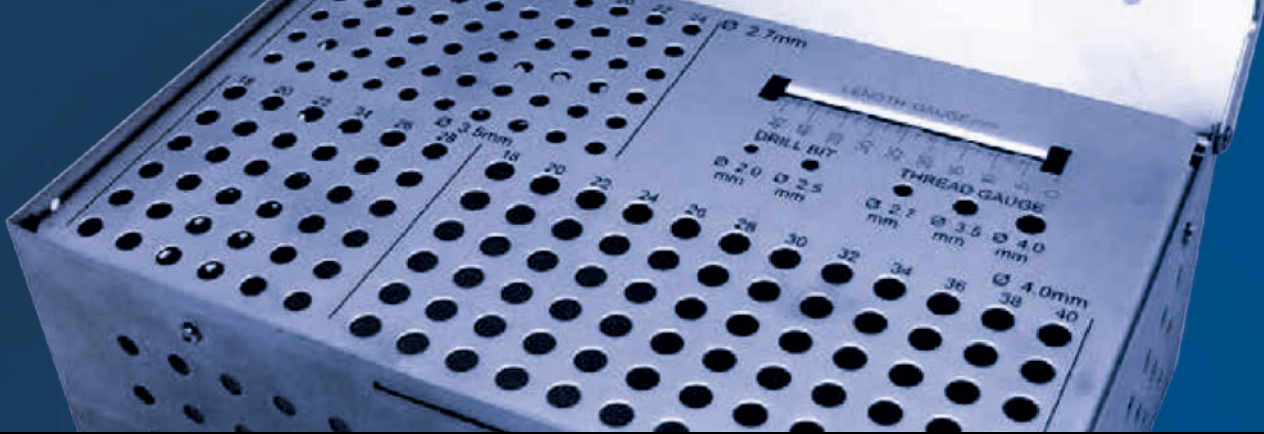

SECUROS puts YOU in the Driver's Seat!

Customize Kits to your needs

- À la carte ordering
- Selective ordering eliminates duplication of parts in your clinic
- Cater your kit to your clinic needs
- Ability to complete your kit over time
- Recommended starter kits are marked in white boxes for your convenience





EXTRACAPSULAR STABILIZATION

Sutures & Needles

Choose one of the following eight options.

Monofilament Nylon

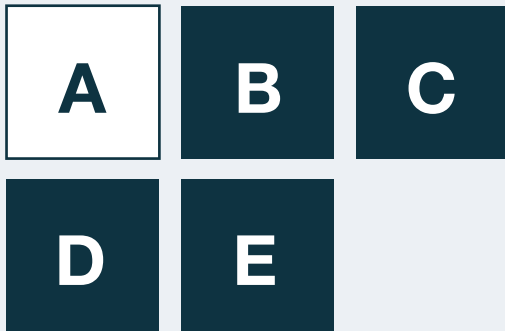

OrthoFiber



Crimp Clamps

Choose one of the following four options.

For use with Monofilament Nylon



For use with OrthoFiber



Instruments

Choose one of the following two options.



Optional Items

Instruments

MWI#	SECUROS#	DESCRIPTION	QTY.
033446	810004	General Surgery Pack	1
040048	001483	Orthopedic Drill Kit	1
035453	001485	Orthopedic Drill Kit with Dual Chuck Hand Chuck and Shroud	1
029059	001237	3/32" x 9" Trocar/Trocar Smooth Pin	1
029061	001239	1/8" X 9" Trocar/Trocar Smooth Pin	1
042165	816520	Freer Periosteal Elevator Double Ended Sharp/Blunt 7.5"	1
030961	815750	Senn Retractor 3 Prong Sharp 6.25"	1
056004	814380	Roger Wire Cutting Scissors 4.75"	1

Other

SECUROS#	DESCRIPTION	MWI#	QTY.
042046 000513	Preforated Tray - Stainless Steel, 10" x 6.5" x 2"		1
029056 001003	Preforated Tray - Stainless Steel, 2.75" x 2' x.5"		1
049104 004870	PowerX Tray		1
044966 004772	Replacement Lid for PowerX Tray		1
031192 001007	Extracapsular Stabilization Organizer Bag		1
035926 001008	Bone Anchor Organizer Bag		1
■ 372164 005491	Extracapsular Stabilization Bone Model		1
035251 001164	Extracapsular Stabilization Instructional CD Rom		1

■ special order item

EXTRACAPSULAR STABILIZATION

Sutures & Needles

A Single Strand Swaged on Monofilament Nylon Suture

MWI# 051734, SECUROS# 005379

MWI#	SECUROS#	DESCRIPTION	QTY.
029035	001178	40# Suture w/Small Cruciate Needle	1
029032	001175	80# Suture w/Medium Cruciate Needle	1
035879	000511	100# Suture w/Medium Cruciate Needle	1

B Double Strand Swaged on Monofilament Nylon Suture

MWI# 051735, SECUROS# 005380

MWI#	SECUROS#	DESCRIPTION	QTY.
029041	001184	40# Suture w/Small Cruciate Needle	1
029038	001181	80# Suture w/Medium Cruciate Needle	1

C Monofilament Nylon Suture Spools & Needles

MWI# 051736, SECUROS# 005381

MWI#	SECUROS#	DESCRIPTION	QTY.
029043	001199	40# Suture	1
029046	001004	80# Suture	1
029047	001106	100# Suture	1
029029	001172	Mini (Size 5) Cruciate Needle (Pkg 6)	1
029030	001173	Cruciate Needle Variety Pack (2-Small, 2-Medium, 2-Large)	1

D Monofilament Nylon Suture Spools & Stainless Steel Bone Anchors

MWI# 051739, SECUROS# 005382

MWI#	SECUROS#	DESCRIPTION	QTY.
029043	001199	40# Suture	1
029046	001004	80# Suture	1
029047	001106	100# Suture	1
030974	001165	2.7mm Bone Anchor - Stainless Steel	2
030975	001166	3.5mm Bone Anchor - Stainless Steel	2
031017	001167	4.5mm Bone Anchor - Stainless Steel	2

E Monofilament Nylon Suture Spools & Titanium Bone Anchors

MWI# 051740, SECUROS# 005383

MWI#	SECUROS#	DESCRIPTION	QTY.
029043	001199	40# Suture	1
029046	001004	80# Suture	1
029047	001106	100# Suture	1
035881	003524	2.7mm Bone Anchor - Titanium	2
035876	003525	3.5mm Bone Anchor - Titanium	2
035874	003526	4.5mm Bone Anchor - Titanium	2

F Single Strand Double Swaged on OrthoFiber Suture

MWI# 051741, SECUROS# 005384

MWI#	SECUROS#	DESCRIPTION	QTY.
035917	000370	#5 Suture w/Small Cruciate & 3" Straight Needles	1
035248	000371	#5 Suture w/Medium Cruciate & 3" Straight Needles	1

G OrthoFiber Suture & Stainless Steel Bone Anchors

MWI# 051742, SECUROS# 005385

MWI#	SECUROS#	DESCRIPTION	QTY.
031032	001104	#5 Suture without Needles	1
030974	001165	2.7mm Bone Anchor - Stainless Steel	2
030975	001166	3.5mm Bone Anchor - Stainless Steel	2
031017	001167	4.5mm Bone Anchor - Stainless Steel	2

H OrthoFiber Suture & Titanium Bone Anchors

MWI# 051743, SECUROS# 005386

MWI#	SECUROS#	DESCRIPTION	QTY.
031032	001104	#5 Suture without Needles	1
035881	003524	2.7mm Bone Anchor - Titanium	2
035876	003525	3.5mm Bone Anchor - Titanium	2
035874	003526	4.5mm Bone Anchor - Titanium	2

Crimp Clamps

A Stainless Steel Crimp Clamps for Monofilament Nylon

MWI# 051744, SECUROS# 005387

MWI#	SECUROS#	DESCRIPTION	QTY.
029023	001148	40# Crimp Clamps	1
029024	001145	80# Crimp Clamps	1
029025	001107	100# Crimp Clamps	1

B Titanium Nitride (TiN) Coated Stainless Steel Crimp Clamps for Monofilament Nylon

MWI# 051745, SECUROS# 005388

MWI#	SECUROS#	DESCRIPTION	QTY.
037936	004351	40# TiN Coated Crimp Clamps	1
037937	004352	80# TiN Coated Crimp Clamps	1
037938	004354	100# TiN Coated Crimp Clamps	1

C Stainless Steel Crimp Clamps for OrthoFiber

MWI#	SECUROS#	DESCRIPTION	QTY.
031031	001105		1

D Titanium Nitride (TiN) Coated Stainless Steel Crimp Clamps for OrthoFiber

MWI#	SECUROS#	DESCRIPTION	QTY.
038483	004559		1

Instruments

A Extracapsular Stabilization Instrumentation Deluxe Kit

MWI# 051747, SECUROS# 005389

MWI#	SECUROS#	DESCRIPTION	QTY.
037934	004033	PowerX Crimping Device	1
031037	001144	Universal Tensioning Device	1
043935	840168	Cruciate Needle Holder - Tungsten Carbide Inserts	1
029517	001479	Dual Chuck Hand Chuck	1
031129	001358	2.4mm Drill Bit, Jacobs Chuck Coupling	2
028992	001357	3.2mm Drill Bit, Jacobs Chuck Coupling	2

B Extracapsular Stabilization Instrumentation Essential Kit

MWI# 051748, SECUROS# 005390

MWI#	SECUROS#	DESCRIPTION	QTY.
037934	004033	PowerX Crimping Device	1
031037	001144	Universal Tensioning Device	1

TIBIAL TUBEROSITY ADVANCEMENT

TTA Cages

Choose one of the following six options.

Stainless Steel



Titanium



TTA Plates

Choose one of the following ten options.

Stainless Steel

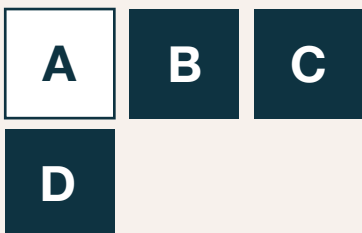

Titanium



2.4mm Screws

Choose one of the following four options.

Stainless Steel



Titanium



2.7/3.5mm Screws

Choose one of the following two options.

Stainless Steel



Titanium



Drill Bits

Choose one of the following two options.



Screwdrivers

Choose one of the following two options.



Instruments

Choose one of the following two options.



TIBIAL TUBEROSITY ADVANCEMENT

TTA CAGES

A Standard TTA Cage Kit - Stainless Steel

MWI# 051750, SECUROS# 005391

MWI#	SECUROS#	WIDTH (mm)	LENGTH (mm)	QTY.
042058	000717	3	13	2
042059	000718	3	16	2
042060	000719	3	19	2
029510	001615	6	16	2
029511	001616	6	19	2
029512	001617	6	22	2
029513	001618	9	19	2
029514	001619	9	22	2
029515	001620	9	25	2
029507	001621	12	22	2
029508	001622	12	25	2
029509	003553	12	28	2
052143	005068	15	25	2
055141	005069	15	28	2
055142	005070	15	31	2

B Standard TTA Cage Kit, Intermediate Sizes - Stainless Steel

MWI# 051751, SECUROS# 005392

MWI#	SECUROS#	WIDTH (mm)	LENGTH (mm)	QTY.
052086	005048	4.5	10	2
052087	005049	4.5	13	2
052088	005050	4.5	16	2
052090	004440	7.5	16	2
052091	004441	7.5	19	2
052092	004442	7.5	22	2
052094	004449	10.5	19	2
052095	004454	10.5	22	2
052096	004456	10.5	25	2
052097	005060	13.5	22	2
052098	005061	13.5	25	2
052099	005062	13.5	28	2

C Cut-to-Length TTA Cage Kit - Stainless Steel

MWI# 051752, SECUROS# 005393

MWI#	SECUROS#	WIDTH (mm)	LENGTH (mm)	QTY.
055161	005044	3	19	2
055162	005052	4.5	16	2
042339	003736	6	22	2
042447	004443	7.5	22	2
042340	003737	9	25	2
043145	004455	10.5	25	2
038422	003738	12	28	2
055163	005064	13.5	28	2
055164	004865	15	31	2
042405	003788	16	34	2
042400	003742	Cage Cutter with Tungsten Carbide Inserts		1

D Standard TTA Cage Kit - Titanium

MWI# 051753, SECUROS# 005394

MWI#	SECUROS#	WIDTH (mm)	LENGTH (mm)	COLOR	QTY.
042061	000720	3	13	Gold	2
036191	000721	3	16	Gold	2
036187	000722	3	19	Gold	2
029486	001624	6	16	Blue	2
029487	001625	6	19	Blue	2
029488	001626	6	22	Blue	2
029489	001627	9	19	Light Blue	2
029491	001628	9	22	Light Blue	2
029492	001629	9	25	Light Blue	2
029483	001101	12	22	Pink	2
029484	001102	12	25	Pink	2
029485	001103	12	28	Pink	2
055158	005065	15	25	Brown	2
055159	005066	15	28	Brown	2
055160	005067	15	31	Brown	2

E Standard TTA Cage Kit, Intermediate Sizes - Titanium

MWI# 051754, SECUROS# 005395

MWI#	SECUROS#	WIDTH (mm)	LENGTH (mm)	COLOR	QT
055144	005045	4.5	10	Green	2
055145	005046	4.5	13	Green	2
055146	005047	4.5	16	Green	2
055148	004445	7.5	16	Copper	2
055149	004446	7.5	19	Copper	2
055150	004447	7.5	22	Copper	2
055152	004457	10.5	19	Purple	2
055153	004462	10.5	22	Purple	2
055154	004463	10.5	25	Purple	2
055155	005057	13.5	22	Yellow	2
055156	005058	13.5	25	Yellow	2
055157	005059	13.5	28	Yellow	2

F Cut-to-Length TTA Cage Kit - Titanium

MWI# 051755, SECUROS# 005396

MWI#	SECUROS#	WIDTH (mm)	LENGTH (mm)	COLOR	QTY.
055165	005043	3	19	Gold	2
055166	005051	4.5	16	Green	2
042341	003739	6	22	Blue	2
042448	004448	7.5	22	Copper	2
042345	003740	9	25	Light Blue	2
042450	004464	10.5	25	Purple	2
042347	003741	12	28	Pink	2
055167	005063	13.5	28	Yellow	2
055168	004866	15	31	Brown	2
042404	003787	16	34	Green	2
042400	003742	Cage Cutter with Tungsten Carbide Inserts			1

Continued →

TIBIAL TUBEROSITY ADVANCEMENT

TTA Plates

A XGEN TTA Plate Kit - Stainless Steel

MWI# 051756, SECUROS# 005397

MWI#	SECUROS#	DESCRIPTION	QTY.
052711	590027	2-2 Hole	2
035873	590000	3-2 Hole	2
035877	590002	4-2 Hole	2
035244	590004	5-2 Hole	2
035249	590006	6-3 Hole	2
035871	590008	7-3 Hole	2
035915	590010	8-3 Hole	2

B XGEN Long TTA Plate Kit - Stainless Steel

MWI# 051757, SECUROS# 005398

MWI#	SECUROS#	DESCRIPTION	QTY.
052712	590029	3-2 Hole - Long	2
052713	590031	4-2 Hole - Long	2
052714	590033	5-2 Hole - Long	2
052715	590035	6-3 Hole - Long	2
052716	590037	7-3 Hole - Long	2
052717	590039	8-3 Hole - Long	2

C Standard TTA Plate & Fork Kit - Stainless Steel

MWI#	SECUROS#	DESCRIPTION	QTY.
052725	005073	2 Hole	2
029493	001091	3 Hole	2
029495	001092	4 Hole	2
029496	001093	5 Hole	2
029497	001094	6 Hole	2
029498	001095	7 Hole	2
029499	001096	8 Hole	2
052739	005087	2 Prong	2
029502	001603	3 Prong	2
029501	001604	4 Prong	2
029503	001605	5 Prong	2
029504	001606	6 Prong	2
029505	001607	7 Prong	2
029506	001608	8 Prong	2

D Standard Long TTA Plate & Fork Kit - Stainless Steel

MWI#	SECUROS#	DESCRIPTION	QTY.
052726	005075	3 Hole - Long	2
052727	005077	4 Hole - Long	2
052728	005079	5 Hole - Long	2
052729	005081	6 Hole - Long	2
052730	005083	7 Hole - Long	2
052731	005085	8 Hole - Long	2
029502	001603	3 Prong	2
029501	001604	4 Prong	2
029503	001605	5 Prong	2
029504	001606	6 Prong	2
029505	001607	7 Prong	2
029506	001608	8 Prong	2

E XGEN TTA Plate Kit (1.0mm Thickness, Purple) - Titanium

MWI# 051758, SECUROS# 005399

MWI#	SECUROS#	DESCRIPTION	QTY.
052718	590028	2-2 Hole	2
042157	591001	3-2 Hole	2
042158	591003	4-2 Hole	2
035869	591005	5-2 Hole	2
042159	591007	6-3 Hole	2
042160	591009	7-3 Hole	2
042161	591011	8-3 Hole	2

F XGEN Long TTA Plate Kit (1.0mm Thickness, Purple) - Titanium, MWI# 051759, SECUROS# 005400

MWI#	SECUROS#	DESCRIPTION	QTY.
052719	590030	3-2 Hole - Long	2
052720	590032	4-2 Hole - Long	2
052721	590034	5-2 Hole - Long	2
052722	590036	6-3 Hole - Long	2
052723	590038	7-3 Hole - Long	2
052724	590040	8-3 Hole - Long	2

G XGEN TTA Plate Kit (1.5mm Thickness, Teal) - Titanium

MWI# 051770, SECUROS# 005401

MWI#	SECUROS#	DESCRIPTION	QTY.
035919	590001	3-2 Hole	2
035914	590003	4-2 Hole	2
042150	590005	5-2 Hole	2
035870	590007	6-3 Hole	2
035916	590009	7-3 Hole	2
035923	590011	8-3 Hole	2

H Standard TTA Plate & Fork Kit (1.0mm Thickness, Teal) - Titanium

MWI#	SECUROS#	DESCRIPTION	QTY.
052732	005072	2 Hole	2
029471	001097	3 Hole	2
029472	001098	4 Hole	2
029473	001099	5 Hole	2
029474	001100	6 Hole	2
029475	001601	7 Hole	2
029476	001602	8 Hole	2
052740	005086	2 Prong	2
042211	001609	3 Prong	2
029478	001610	4 Prong	2
029479	001611	5 Prong	2
029480	001612	6 Prong	2
029481	001613	7 Prong	2
029482	001614	8 Prong	2

I Standard Long TTA Plate & Fork Kit (1.0mm Thickness, Teal) - Titanium

MWI#	SECUROS#	DESCRIPTION	QTY.
052733	005074	3 Hole - Long	2
052734	005076	4 Hole - Long	2
052735	005078	5 Hole - Long	2
052736	005080	6 Hole - Long	2
052737	005082	7 Hole - Long	2
052738	005084	8 Hole - Long	2
042211	001609	3 Prong	2
029478	001610	4 Prong	2
029479	001611	5 Prong	2
029480	001612	6 Prong	2
029481	001613	7 Prong	2
029482	001614	8 Prong	2

TIBIAL TUBEROSITY ADVANCEMENT

2.4mm Screws

A 2.4mm Cortical Screw, Self-Tapping, Cruciform Recess Kit - Stainless Steel

MWI# 051773, SECUROS# 005404

MWI#	SECUROS#	LENGTH (mm)	QTY.
047227	100095	6	4
047228	100096	7	4
047229	100097	8	4
047230	100098	9	4
047231	100099	10	4
047232	100100	11	4
047233	100101	12	4
047234	100102	13	4
047235	100103	14	4
047236	100104	16	4
047237	100105	18	4
047238	100106	20	4
047239	100107	22	4
047240	100108	24	4
047241	100109	26	4
047242	100110	28	4
047243	100111	30	4
047244	100112	32	4
047245	100113	34	4
047246	100114	36	4
047247	100115	38	4
047248	100116	40	4

C 2.4 mm Cortical Screw, Self-Tapping, Cruciform Recess Kit - Titanium (Copper)

MWI# 051775, SECUROS# 005406

MWI#	SECUROS#	LENGTH (mm)	QTY.
■ 370030	100089	6	4
■ 370031	100090	7	4
■ 370032	100091	8	4
■ 370033	100092	9	4
049255	005021	10	4
■ 370034	100093	11	4
049256	005023	12	4
■ 370035	100094	13	4
049257	005024	14	4
049258	005025	16	4
049259	005026	18	4
049260	005027	20	4
049261	005028	22	4
049262	005029	24	4
049263	005030	26	4
049264	005031	28	4
049265	005032	30	4
049267	005033	32	4
049268	005034	34	4
049269	005035	36	4
049270	005036	38	4
049271	005037	40	4

B 2.4mm Cortical Screw, Self-Tapping, Hexagonal Recess Kit - Stainless Steel

MWI# 051772, SECUROS# 005403

MWI#	SECUROS#	LENGTH (mm)	QTY.
042298	002613	6	4
■ 370020	005133	7	4
042299	002614	8	4
■ 370021	005134	9	4
030982	001027	10	4
■ 370022	005135	11	4
030983	001028	12	4
■ 370023	005136	13	4
030984	001029	14	4
030985	001030	16	4
030986	001031	18	4
030987	001032	20	4
030980	001033	22	4
030988	001034	24	4
030989	001035	26	4
030981	001036	28	4
030990	001037	30	4
030991	001038	32	4
030992	001039	34	4
030993	001040	36	4
030994	001041	38	4
030995	001042	40	4

D 2.4mm Cortical Screw, Self-Tapping, Hexagonal Recess - Titanium (Copper)

MWI# 051774, SECUROS# 005405

MWI#	SECUROS#	LENGTH (mm)	QTY.
042300	002684	6	4
■ 370025	005138	7	4
042301	002685	8	4
■ 370027	005140	9	4
031038	001043	10	4
■ 370028	005141	11	4
031039	001044	12	4
■ 370029	005142	13	4
031040	001045	14	4
031041	001046	16	4
031042	001047	18	4
031043	001048	20	4
031044	001049	22	4
031045	001050	24	4
031046	001051	26	4
031047	001052	28	4
031048	001053	30	4
031049	001054	32	4
031050	001055	34	4
031051	001056	36	4
031052	001057	38	4
031053	001058	40	4

Continued →

■ special order item

TIBIAL TUBEROSITY ADVANCEMENT

2.7/3.5mm Screws

A 2.7/3.5mm Cortical Screw, Self-Tapping, Hexagonal Recess Kit-Stainless Steel

MWI# 051776, SECUROS# 005407

2.7mm

MWI#	SECUROS#	LENGTH (mm)	QTY.
029167	001879	10	2
029168	001880	12	2
029169	001881	14	2
029170	001882	16	2
029171	001883	18	2
029172	001630	20	2
029173	001631	22	2
029174	001632	24	2
029175	001633	26	2
029176	001634	28	2
029177	001635	30	2
029178	001636	32	2

3.5mm

MWI#	SECUROS#	LENGTH (mm)	QTY.
029200	001885	10	2
029201	001886	12	2
029202	001887	14	2
029203	001888	16	2
029204	001889	18	2
029205	001890	20	2
029207	001891	22	2
029208	001892	24	2
029209	001893	26	2
029210	001894	28	2
029211	001895	30	2
029212	001896	32	2

B 2.7/3.5mm Cortical Screw, Self-Tapping, Hexagonal Recess Kit- Titanium

MWI# 051777, SECUROS# 005408

2.7mm (Blue)

MWI#	SECUROS#	LENGTH (mm)	QTY.
031054	001059	10	2
031055	001060	12	2
031056	001061	14	2
031057	001062	16	2
031058	001063	18	2
031059	001064	20	2
031060	001065	22	2
031061	001066	24	2
031062	001067	26	2
031063	001068	28	2
042074	001069	30	2
042075	001070	32	2

3.5mm (Gold)

MWI#	SECUROS#	LENGTH (mm)	QTY.
042080	001075	10	2
031070	001076	12	2
031071	001077	14	2
031072	001078	16	2
031073	001079	18	2
031074	001080	20	2
031075	001081	22	2
031076	001082	24	2
031077	001083	26	2
031078	001084	28	2
031079	001085	30	2
042082	001086	32	2

Drill Bits

A Jacobs Chuck Coupling Drill Bit Kit (BITE Bit, Titanium Nitride Coated)

MWI#	SECUROS#	DIAMETER (mm)	QTY.
031139	001017	1.8	2
028995	002036	2.0	2
028996	002037	2.5	2

B Quick Coupling Drill Bit Kit (BITE Bit, Titanium Nitride Coated)

MWI#	SECUROS#	DIAMETER (mm)	QTY.
036059	000395	1.8	2
029010	001018	2.0	2
029011	001019	2.5	2

Screwdrivers

A Screwdriver Kit (Includes holding sleeves)

MWI#	SECUROS#	DESCRIPTION	QTY.
035880	003237	2.4mm Hexagonal Screwdriver	1
042073	001026	1.5/2.0/2.4mm Cruciform Screwdriver	1
029524	001024	2.7/3.5/4.0mm Hexagonal Screwdriver	1

B Quick Coupling Screwdriver Shaft & Handle Kit (Includes holding sleeves)

MWI#	SECUROS#	DESCRIPTION	QTY.
055102	003904	2.4mm Hexagonal Screwdriver Shaft	1
056007	003827	1.5/2.0/2.4mm Cruciform Screwdriver Shaft	1
029525	001025	2.7/3.5/4.0mm Hexagonal Screwdriver Shaft	1
029529	007003	Small Handle	1

TIBIAL TUBEROSITY ADVANCEMENT

Instruments

A XGEN Instrument Kit (For use with XGEN TTA Plates)

MWI#	SECUROS#	DESCRIPTION	QTY.
031140	003095	TTA Plate Bender	1
031144	001014	TTA T-Handle	1
044669	000723	3mm TTA Spacer	1
031148	002930	6mm TTA Spacer	1
031149	002931	9mm TTA Spacer	1
031146	002922	12mm TTA Spacer	1
045407	004175	16mm TTA Spacer	1
055050	003824	1.8/2.4mm Double Drill Guide	1
031195	001022	2.0/2.7mm Double Drill Guide	1
030996	001023	2.5/3.5mm Double Drill Guide	1
029097	002049	1.5/2.0/2.4mm Depth Gauge	1
029098	001020	2.7/3.5/4.0mm Depth Gauge	1

B Standard Instrument Kit (For use with Standard TTA Plates)

MWI#	SECUROS#	DESCRIPTION	QTY.
031140	003095	TTA Plate Bender	1
031144	001014	TTA T-Handle	1
044669	000723	3mm TTA Spacer	1
031148	002930	6mm TTA Spacer	1
031149	002931	9mm TTA Spacer	1
031146	002922	12mm TTA Spacer	1
045407	004175	16mm TTA Spacer	1
055050	003824	1.8/2.4mm Double Drill Guide	1
031195	001022	2.0/2.7mm Double Drill Guide	1
030996	001023	2.5/3.5mm Double Drill Guide	1
029097	002049	1.5/2.0/2.4mm Depth Gauge	1
029098	001020	2.7/3.5/4.0mm Depth Gauge	1
045519	000724	Fork Drill Guide - 4 Holes	1
031141	001015	Fork Drill Guide - 8 Holes	1
031147	002921	1.9mm Posts (Pack of 2) for 2.0mm Drill Bit	1
031143	002069	Fork Insertor	1

Optional Items

Implants

MWI#	SECUROS#	DESCRIPTION	QTY.
■ 372167	004745	2mm Tubular PLX Spacer - Stainless Steel	1
■ 372168	004746	4mm Tubular PLX Spacer - Stainless Steel	1
■ 372169	004747	6mm Tubular PLX Spacer - Stainless Steel	1
045527	004708	2mm Tubular PLX Spacer - Titanium	1
045061	004709	4mm Tubular PLX Spacer - Titanium	1
045062	004710	6mm Tubular PLX Spacer - Titanium	1
042429	004329	2mm PLX Spacer - Stainless Steel	1
042431	004331	4mm PLX Spacer - Stainless Steel	1
042433	004333	6mm PLX Spacer - Stainless Steel	1
042430	004330	2mm PLX Spacer - Titanium	1
042432	004332	4mm PLX Spacer - Titanium	1
042434	004334	6mm PLX Spacer - Titanium	1
032390	000841	Velocity Synthetic Bone Graft Particulate (Two 2.5cc)	1
035245	003756	Velocity Synthetic Bone Graft Putty (2.5cc)	1
032391	000842	Velocity Synthetic Bone Graft Putty (5cc)	1

Instruments

MWI#	SECUROS#	DESCRIPTION	QTY.
033446	810004	General Surgery Pack	1
035878	840345	Point-to-Point Reduction Forceps with Ratchet 5.5"	1
045001	840346	Point-to-Point Reduction Forceps with Ratchet 8.5"	1
048375	840400	Lucae Mallet (250 g) 7.5"	1
029528	001916	Large Handle	1
	007361	Silicone Handle	1
042165	816520	Freer Periosteal Elevator Double Ended Sharp/Blunt 7.5"	1
030961	815750	Senn Retractor 3 Prong Sharp 6.25"	1

Other

MWI#	SECUROS#	DESCRIPTION	QTY.
042439	005324	XGEN TTA Case with Trays	1
■ 276414	000377	XGEN TTA Bone Model	1
■ 388997	005493	TTA Pre-Op Planning Guide	1
036013	003097	XGEN TTA Instructional DVD	1

■ special order item

TIBIAL PLATEAU LEVELING OSTEOTOMY

TPLO Plates

Choose one of the following two options.

Stainless Steel



Titanium



Drill Guides

Choose one of the following three options.



2.7/3.5mm Screws

Choose one of the following two options.

Stainless Steel



Titanium



Screwdrivers

Choose one of the following two options.

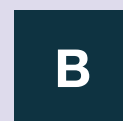
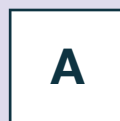

TPLO Jig & Pins

Choose one of the following two options.



Bending Instruments

Choose one of the following three options.

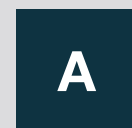

Power Equipment

Choose one of the following two options.



Drill Bits

Choose one of the following two options.

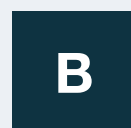
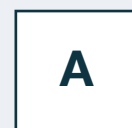

TPLO Blades

Choose one of the following three options.

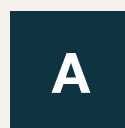

TIBIAL PLATEAU LEVELING OSTEOTOMY

TPLO Plates

A TPLO Plate Kit - Stainless Steel

MWI#	SECUROS#	DESCRIPTION	QTY.
035925	003243	2.7mm Left	2
035932	003244	2.7mm Right	2
036063	003658	2.7mm Broad Left	2
036068	003657	2.7mm Broad Right	2
031022	001129	3.5mm Left	2
031021	001130	3.5mm Right	2
035250	000776	3.5mm Broad Left	2
035868	000775	3.5mm Broad Right	2

B TPLO Plate Kit - Titanium (Gold)

MWI#	SECUROS#	DESCRIPTION	QTY.
042416	003973	3.5mm Left	2
042417	003974	3.5mm Right	2

2.7/3.5mm Screws

A 2.7/3.5mm Cortical Screw, Self-Tapping, Hexagonal Recess Kit - Stainless Steel

2.7mm

MWI#	SECUROS#	LENGTH (mm)	QTY.
029169	001881	14	6
029170	001882	16	6
029171	001883	18	6
029172	001630	20	6
029173	001631	22	6
029174	001632	24	6
029175	001633	26	6
029176	001634	28	6
029177	001635	30	6
029178	001636	32	6
031117	002549	34	6
031152	002550	36	6
035974	003554	38	6
042294	002551	40	6

3.5mm

MWI#	SECUROS#	LENGTH (mm)	QTY.
029202	001887	14	6
029203	001888	16	6
029204	001889	18	6
029205	001890	20	6
029207	001891	22	6
029208	001892	24	6
029209	001893	26	6
029210	001894	28	6
029211	001895	30	6
029212	001896	32	6
029213	001897	34	6
029214	001898	36	6
029215	001899	38	6
029216	002101	40	6
042451	004470	42	6
042452	004471	44	6
031119	002593	45	6

B 3.5mm Cortical Screw, Self-Tapping, Hexagonal Recess Kit - Titanium (Gold)

3.5mm

MWI#	SECUROS#	LENGTH (mm)	QTY.
029202	001887	14	6
029203	001888	16	6
029204	001889	18	6
029205	001890	20	6
029207	001891	22	6
029208	001892	24	6
029209	001893	26	6
029210	001894	28	6
029211	001895	30	6
029212	001896	32	6
029213	001897	34	6
029214	001898	36	6
029215	001899	38	6
029216	002101	40	6
042451	004470	42	6
042452	004471	44	6
031119	002593	45	6

Continued →

TIBIAL PLATEAU LEVELING OSTEOTOMY

Bending Instruments

A Plate Bender for SECUROS TPLO Plates (Set of 2)

MWI#	SECUROS#	QTY.
056030	001142	1

B Large Bending Iron for 2.7/3.5mm TPLO Plates

MWI#	SECUROS#	QTY.
042314	002948	1

C Large Bending Pliers

MWI#	SECUROS#	QTY.
044054	002064	1

Drill Bits

A Jacobs Chuck Coupling Drill Bit Kit

(BITE Bit, Titanium Nitride Coated)

MWI#	SECUROS#	DIAMETER (mm)	QTY.
028995	002036	2.0	2
028996	002037	2.5	2

B Quick Coupling Drill Bit Kit

(BITE Bit, Titanium Nitride Coated)

MWI#	SECUROS#	DIAMETER (mm)	QTY.
029010	001018	2.0	2
029011	001019	2.5	2

Drill Guides

A Double Drill Guide Kit

MWI#	SECUROS#	DESCRIPTION	QTY.
031195	001022	2.0/2.7mm Double Drill Guide	1
030996	001023	2.5/3.5mm Double Drill Guide	1

B Compressional Drill Guide Kit

MWI#	SECUROS#	DESCRIPTION	QTY.
042238	001903	2.7mm Compressional Drill Guide	1
029018	001904	3.5mm Compressional Drill Guide	1

C Universal Drill Guide Kit

MWI#	SECUROS#	DESCRIPTION	QTY.
042267	002279	3.5mm Universal Drill Guide	1

Screwdrivers

A Screwdriver Kit (Includes holding sleeve)

MWI#	SECUROS#	DESCRIPTION	QTY.
029524	001024	2.7/3.5/4.0mm Hexagonal Screwdriver	1

B Quick Coupling Screwdriver Shaft & Handle Kit (Includes holding sleeve)

MWI#	SECUROS#	DESCRIPTION	QTY.
029525	001025	2.7/3.5/4.0mm Hexagonal Screwdriver Shaft	1
029529	007003	Small Handle	1

TIBIAL PLATEAU LEVELING OSTEOTOMY

TPLO Jig & Pins

A TPLO Jig & Smooth Pin Kit

MWI#	SECUROS#	DESCRIPTION	QTY.
042437	004356	TPLO Jig	1
029057	001235	1/16" x 9" Trocar/Trocar Smooth Pin	2
048256	003587	3/32" x 4.5" Trocar Smooth Pin	2
031003	003099	1/8" x 4.5" Trocar Smooth Pin	2
029061	001239	1/8" x 9" Trocar/Trocar Smooth Pin	2
036209	001458	1/4" Side Pin Cutter with Detachable Handles 18.5"	1
042096	840406	5/64" Side Angled Pin Cutter 7"	1

B TPLO Jig & Partially Threaded Pin Kit

MWI#	SECUROS#	DESCRIPTION	QTY.
042437	004356	TPLO Jig	1
029068	001257	1/16" x 9" Trocar/Trocar Partially Threaded Pin	2
035918	003586	3/32" x 4.5" Trocar Partially Threaded Pin	2
031005	002985	1/8" x 4.5" Trocar Partially Threaded Pin	2
029072	002956	1/8" x 9" Trocar/Trocar Partially Threaded Pin	2
036209	001458	1/4" Side Pin Cutter with Detachable Handles 18.5"	1
042096	840406	5/64" Side Angled Pin Cutter 7"	1

Power Equipment

A TPLO Saw Kit

MWI#	SECUROS#	DESCRIPTION	QTY.
042036	000411	TPLO Saw	1
042053	000629	1/8" Hex Key	1
042037	000412	Hose for TPLO Saw (Schrader Connection)	1

B Slocum TPLO Saw Kit

MWI#	SECUROS#	DESCRIPTION	QTY.
■ 372089	004423	Slocum TPLO Saw	1
■ 372090	004424	Hose for Slocum TPLO Saw (Schrader Connection)	1
052742	005096	Blade Adaptor for Slocum TPLO Saw	1

TPLO Blades

A Aesculap TPLO Blade Kit

MWI#	SECUROS#	DESCRIPTION	QTY.
■ 276403	004241	18mm Radius	1
048760	004242	20mm Radius	1
048755	004243	24mm Radius	1
		27mm Radius	1
045191	004245	30mm Radius	1

B TPLO Blade Kit

MWI#	SECUROS#	DESCRIPTION	QTY.
049099	004781	12mm Radius	1
048944	005318	15mm Radius	1
045539	003913	18mm Radius	1
055121	005071	21mm Radius	1
042411	003912	24mm Radius	1
045563	004244	27mm Radius	1
056031	003993	30mm Radius	1

C Hub System TPLO Blade Kit

MWI#	SECUROS#	DESCRIPTION	QTY.
056028	000408	18mm Radius	1
035971	000409	24mm Radius	1
056027	000410	30mm Radius	1
042035	000406	TPLO Blade Hub	1
036193	000407	TPLO 30mm Blade Adaptor	1
042053	000629	1/8" Hex Key	1

Optional Items

Implants

MWI#	SECUROS#	DESCRIPTION	QTY.
042403	003784	2.0mm Left TPLO Plate - Stainless Steel	1
042402	003783	2.0mm Right TPLO Plate - Stainless Steel	1

■ special order item

Optional Items

Instruments

MWI#	SECUROS#	DESCRIPTION	QTY.
033446	810004	General Surgery Pack	1
042253	002056	Small Bending Iron for 2.0mm TPLO Plates	1
045449	002063	Medium Bending Pliers	1
043932	003027	Curved Castroviejo Caliper	1
035878	840345	Point-to-Point Reduction Forceps with Ratchet 5.5"	1
045001	840346	Point-to-Point Reduction Forceps with Ratchet 8.5"	1
029528	001916	Large Handle	1
052748	007180	Silicone Handle	1
030961	815750	Senn Retractor 3 Prong Sharp 6.25"	1
048375	840400	Lucae Mallet (250 g) 7.5"	1
042248	840254	4mm Lambotte Osteotome	1
045603	840255	6mm Lambotte Osteotome	1
045076	840257	8mm Lambotte Osteotome	1
045604	840259	10mm Lambotte Osteotome	1
045344	840260	12mm Lambotte Osteotome	1
044993	840307	6mm AO Periosteal Elevator Straight Round Edge 7"	1
044895	840305	14mm AO Periosteal Elevator Straight Round Edge 7.5"	1
055010	001932	6mm Ferrozell Periosteal Elevator	1
055009	001931	8mm Ferrozell Periosteal Elevator	1
042165	816520	Freer Periosteal Elevator Double Ended Sharp/Blunt 7.5"	1
035922	840178	3.5" Gelpi Retractor	1
036190	840179	4.5" Gelpi Retractor	1
055012	808920	5.5" Gelpi Retractor	1
056026	000849	Oscillating Adaptor for TPLO Saw	1
035820	840405	7/64" Side Pin Cutter 9.25"	1
■ 276424	003759	1/8" Front Pin Cutter 10"	1
048648	840843	7/64" Hercules Side Pin Cutter 9.25"	1
045560	000881	2.7/3.5/4.0mm Screw Rack	1

Other

MWI#	SECUROS#	DESCRIPTION	QTY.
■	004574	TPLO Bone Model	1

MENISCAL MANAGEMENT

Meniscal Management Kit

A Meniscal Management Kit



MWI#	SECUROS#	DESCRIPTION	QTY.
031033	001310	Micro Beaver Blade Handle	1
031036	001311	Micro Beaver Blade Size 6400, Box of 12	1
055014	813880	8mm Hohmann Retractor	1
042170	840190	Stifle Retractor with Speedlock 7"	1
035928	002481	Meniscus Probe 2.5mm Tip	1
040399	840399	Halsted Mosquito Forceps Straight 1x2 Teeth 5"	1

Optional Items

MWI#	SECUROS#	DESCRIPTION	QTY.
045520	001350	Perforated Tray - Stainless Steel, 9" x 5" x 2"	1

PATELLAR LUXATION

Patellar Luxation Kit

A Patellar Luxation Kit



MWI#	SECUROS#	DESCRIPTION	QTY.
030965	001009	PLX Saw	1
042248	840254	4mm Lambotte Osteotome	1
045603	840255	6mm Lambotte Osteotome	1
045076	840257	8mm Lambotte Osteotome	1
048375	840400	Lucae Mallet (250 g)	1
036188	840352	Fomon Rasp & File	1
046143	840358	Trochlear Groove Rasp	1
■ 372092	003979	Molar Splitter	1
029089	001277	0.035" x 9" K-wire - Pack of 6	1
029090	001278	0.045" x 9" K-wire - Pack of 6	1
029091	001279	0.054" x 9" K-wire - Pack of 6	1
029092	001280	0.062" x 9" K-wire - Pack of 6	1
029080	001267	22 Gauge Orthopedic Wire 1 oz Spool	1
029079	001266	20 Gauge Orthopedic Wire 1 oz Spool	1
029078	001265	18 Gauge Orthopedic Wire 1 oz Spool	1
029077	001264	16 Gauge Orthopedic Wire 1 oz Spool	1
055140	840929	Universal K-wire Bender	1

Optional Items

MWI#	SECUROS#	DESCRIPTION	QTY.
045520	001350	Perforated Tray - Stainless Steel, 9" x 5" x 2"	1
390152	002062	Double K-wire Bender	1
045293	840403	5/64" Side Pin Cutter 5.75"	1
042096	840406	5/64" Side Angled Pin Cutter 7"	1
045027	840404	7/64" Side Angled Pin Cutter 8.75"	1
035820	840405	7/64" Side Pin Cutter 9.25"	1
048374	840927	1/16" Cannulated Front Pin Cutter 7.5"	1
■ 276424	003759	1/8" Front Pin Cutter 10"	1

■ special order item

COXOFEMORAL LUXATION MANAGEMENT

Toggle Rods

Choose one of the following two options.



Suture

Choose one of the following three options.



Instruments



Drill Bits

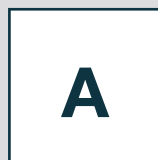

Optional Items

Implants

MWI#	SECUROS#	DESCRIPTION	QTY.
042048	000600	5/64" Toggle Rod	1
042057	000650	3/32" Toggle Rod	1
035929	002329	1/4" Toggle Rod	1
029042	001198	20# Monofilament Nylon Suture Spool	1
029045	002073	60# Monofilament Nylon Suture Spool	1
029047	001106	100# Monofilament Nylon Suture Spool	1

MWI#	SECUROS#	DESCRIPTION	QTY.
031129	001358	2.4mm Drill Bit - Jacobs Chuck Coupling	1
042090	001361	2.4mm Drill Bit - Quick Coupling	1
045544	001362	3.2mm Drill Bit - Quick Coupling	1
045559	000644	4.0mm Drill Bit - Quick Coupling	1

Instruments

MWI#	SECUROS#	DESCRIPTION	QTY.
033446	810004	General Surgery Pack	
042268	002327	O-Ring for Toggle Rod Insertion Device	1
■ 372093	840865	10x17mm Hatt Spoon	1
045022	840375	15x23mm Hatt Spoon	1
■ 372094	840866	20x34mm Hatt Spoon	1
045266	840210	16x52mm Meyerding Retractor	1
045989	840211	25x75mm Meyerding Retractor	1
049062	840212	50x89mm Meyerding Retractor	1
045262	840193	Army Retractor (Set of 2)	1
090016	802013	Aufranc Cobra Retractor	1
■ 372166	840949	25mm Hohmann Retractor	1
035922	840178	3.5" Gelpi Retractor	1
036190	840179	4.5" Gelpi Retractor	1
055012	808920	5.5" Gelpi Retractor	1
039505	808940	7.5" Gelpi Retractor	1

Other

MWI#	SECUROS#	DESCRIPTION	QTY.
029056	001003	Preforated Tray - Stainless Steel, 2.75" x 2" .5"	1
045520	001350	Perforated Tray - Stainless Steel, 9" x 5" x 2"	1
031193	001512	CLM Organizer Bag	1
■ 372165	005492	CLM Bone Model	1

■ special order item

COXOFEMORAL LUXATION MANAGEMENT

Toggle Rods

A Toggle Rod Kit

MWI#	SECUROS#	DIAMETER (")	QTY.
035246	001517	1/8	2
035924	002331	5/32	2

B Modified Piermattei Toggle Rod Kit

MWI#	SECUROS#	PIN DIAMETER (")	QTY.
■ 372183	005489	.045	2
■ 372184	005490	3/32	2

Instruments

A Instrumentation for Coxofemoral Luxation Management

MWI#	SECUROS#	DESCRIPTION	QTY.
035930	001513	Universal Aiming Device	1
035972	001515	Monofilament Nylon Puller	1
036053	001514	Toggle Rod Insertion Device	1
036052	001516	O-Ring for Toggle Rod Insertion Device (Pkg. 6)	1

Suture

A Monofilament Nylon Suture Spool Kit

MWI#	SECUROS#	DESCRIPTION	QTY.
029043	001199	40# Suture	1
029042	001004	80# Suture	1

B #5 OrthoFiber Suture Kit

MWI#	SECUROS#	DESCRIPTION	QTY.
031032	001104	#5 OrthoFiber Suture without Needles	1

C #2 OrthoFiber Suture Kit

MWI#	SECUROS#	DESCRIPTION	QTY.
055171	005506	#2 OrthoFiber Suture without Needles	1

Drill Bits

A Jacobs Chuck Coupling Drill Kit (BITE Bit, Titanium Nitride Coated)

MWI#	SECUROS#	DIAMETER (mm)	QTY.
028992	001357	3.2	2
031130	001360	4.0	2

FEMORAL HEAD OSTEOTOMY

Instruments



A Femoral Head Osteotomy Kit

MWI#	SECUROS#	DESCRIPTION	QTY.
045022	840375	15x23mm Hatt Spoon	1
045262	840193	Army Retractor (Set of 2)	1
045236	816290	Kern Forceps with Ratchet 8.5"	1
045366	840684	8mm Hoke Osteotome	1
045084	840685	10mm Hoke Osteotome	1
048375	840400	Lucae Mallet (250 g) 7.5"	1
036188	840352	Fomon Rasp & File	1
042162	810580	Lempert Rongeur, 3x10mm Bite Curved 6.5"	1

Optional Items

MWI#	SECUROS#	DESCRIPTION	QTY.
033446	810004	General Surgery Pack	1
■ 372093	840865	10x17mm Hatt Spoon	1
045022	840375	15x23mm Hatt Spoon	1
■ 372094	840866	20x34mm Hatt Spoon	1
030961	815750	Senn Retractor 3 Prong Sharp 6.25"	1
043916	840329	Clamshell Forceps with Speedlock 7"	1
045603	840255	6mm Lambotte Osteotome	1
045076	840257	8mm Lambotte Osteotome	1
045604	840259	10mm Lambotte Osteotome	1
045074	840248	6mm Hoke Osteotome	1
042163	813670	Mead Mallet (320 g) 7.5"	1
045272	840219	Liston Bone Cutting Forceps Angled on Flat 7.5"	1
045347	840353	Putti Bone Rasp - Double Ended Flat Blades 10.5"	1
049208	840354	Putti Bone Rasp - Double Ended Round & Flat Blades 12"	1
044055	840222	Lempert Rongeur 3x10mm Bite Straight 6.5"	1
■ 370194	840223	Adson Rongeur 9x17mm Bite Straight 8"	1
044990	840227	Ruskin Rongeur 3x10mm Bite Curved 6"	1
045073	840228	Ruskin Rongeur 4x15mm Bite Straight 7.25"	1

■ special order item



LINEAR EXTERNAL SKELETAL FIXATION

ESF Pins

Choose one of the following four options.

Small TITAN System



Large TITAN System



Small U System



Large U System



Pin Placement Device

Choose one of the following four options.

Small TITAN System



Large TITAN System



Small U System



Large U System



Drill Bits

Choose one of the following four options.

Small TITAN System

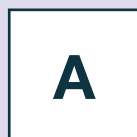

Large TITAN System

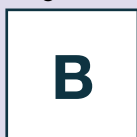

Small U System



Large U System

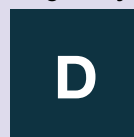

Fixation Clamps

Choose one of the following four options.

Small TITAN System



Large TITAN System

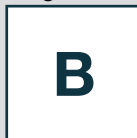

Small U System



Large U System



Connecting Rods

Choose one of the following five options.

Small TITAN System



Large TITAN System



Small U System



Large U System



Wrenches

Choose one of the following two options.

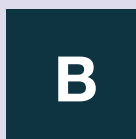
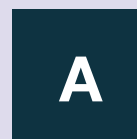

Nut Drivers

Choose one of the following two options.

Small Systems

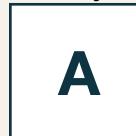

Large Systems



OR

LINEAR EXTERNAL SKELETAL FIXATION

External Skeletal Fixation Pins

A Small TITAN ESF Pin Kit

MWI#	SECUROS#	DESCRIPTION	QTY.
028970	001396	1/16" Mini End-Threaded Positive Profile	8
028974	001801	3/32" Small End-Threaded Positive Profile	8
028972	001398	1/8" Medium End-Threaded Positive Profile	8
028971	001397	1/16" Mini Center-Threaded Positive Profile	6
028975	001802	3/32" Small Center-Threaded Positive Profile	6
028973	001399	1/8" Medium Center-Threaded Positive Profile	6

B Large TITAN ESF Pin Kit

MWI#	SECUROS#	DESCRIPTION	QTY.
028972	001398	1/8" Medium End-Threaded Positive Profile	8
028973	001399	1/8" Medium Center-Threaded Positive Profile	6
028976	001803	5/32" Large End-Threaded Positive Profile	8
028977	001804	5/32" Large Center-Threaded Positive Profile	6

C Small ESF Pin Kit

MWI#	SECUROS#	DESCRIPTION	QTY.
028970	001396	1/16" Mini End-Threaded Positive Profile	8
028974	001801	3/32" Small End-Threaded Positive Profile	8
028971	001397	1/16" Mini Center-Threaded Positive Profile	6
028975	001802	3/32" Small Center-Threaded Positive Profile	6

D Large ESF Pin Kit

MWI#	SECUROS#	DESCRIPTION	QTY.
028974	001801	3/32" Small End-Threaded Positive Profile	8
028972	001398	1/8" Medium End-Threaded Positive Profile	8
028975	001802	3/32" Small Center-Threaded Positive Profile	6
028973	001399	1/8" Medium Center-Threaded Positive Profile	6

Pin Placement Device

A Pin Placement Device for Small Titan System

MWI#	SECUROS#	QTY.
056025	002360	1

B Pin Placement Device for Large Titan System

MWI#	SECUROS#	QTY.
044056	001365	1

C Pin Placement Device for Small U System

MWI#	SECUROS#	QTY.
031185	001364	1

D Pin Placement Device for Large U System

MWI#	SECUROS#	QTY.
031184	001363	1

Drill Bits

A Jacobs Chuck Coupling Drill Bit Kit for Small TITAN System (BITE Bit, Titanium Nitride Coated)

MWI#	SECUROS#	DIAMETER (mm)	QTY.
031128	001359	1.5	2
031129	001358	2.4	2
028992	001357	3.2	2

B Jacobs Chuck Coupling Drill Bit Kit for Large TITAN System (BITE Bit, Titanium Nitride Coated)

MWI#	SECUROS#	DIAMETER (mm)	QTY.
028992	001357	3.2	2
031130	001360	4.0	2

C Jacobs Chuck Coupling Drill Bit Kit for Small U System (BITE Bit, Titanium Nitride Coated)

MWI#	SECUROS#	DIAMETER (mm)	QTY.
031128	001359	1.5	2
031129	001358	2.4	2

D Jacobs Chuck Coupling Drill Bit Kit for Large U System (BITE Bit, Titanium Nitride Coated)

MWI#	SECUROS#	DIAMETER (mm)	QTY.
031129	001358	2.4	2
028992	001357	3.2	2

Fixation Clamps

A Small TITAN Clamp Kit

MWI#	SECUROS#	QTY.
031020	002356	12

B Large TITAN Clamp Kit

MWI#	SECUROS#	QTY.
031019	001368	12

C Small U Clamp Kit

MWI#	SECUROS#	QTY.
031018	001369	12

D Large U Clamp Kit

MWI#	SECUROS#	QTY.
031016	001366	12

LINEAR EXTERNAL SKELETAL FIXATION

Connecting Rods

A Connecting Rod Kit for Small TITAN System - Carbon Fiber

MWI#	SECUROS#	DIAMETER	LENGTH (")	QTY.
031179	002351	1/4" (6.3mm)	2	2
031180	002352	1/4" (6.3mm)	4	2
031181	002353	1/4" (6.3mm)	6	2
031182	002354	1/4" (6.3mm)	8	2
031183	002355	1/4" (6.3mm)	10	2

B Connecting Rod Kit for Large TITAN System - Carbon Fiber

MWI#	SECUROS#	DIAMETER	LENGTH (")	QTY.
031125	002214	3/8" (9.5mm)	6	2
031126	002215	3/8" (9.5mm)	8	2
030967	002216	3/8" (9.5mm)	10	2
030968	002217	3/8" (9.5mm)	12	2
045470	002218	3/8" (9.5mm)	14	2

C Connecting Rod Kit for Large TITAN System - Aluminum

MWI#	SECUROS#	DIAMETER	LENGTH (")	QTY.
090012	022208	3/8" (9.5mm)	6	2
044926	002209	3/8" (9.5mm)	8	2
044928	002346	3/8" (9.5mm)	10	2
055093	002210	3/8" (9.5mm)	12	2
044927	002211	3/8" (9.5mm)	14	2

D Connecting Rod Kit for Small U System - Stainless Steel

MWI#	SECUROS#	DIAMETER	LENGTH (")	QTY.
028980	002178	1/8" (3.2mm)	4	2
028981	002097	1/8" (3.2mm)	5	2
028982	002098	1/8" (3.2mm)	6	2
028983	002099	1/8" (3.2mm)	8	2
028984	002100	1/8" (3.2mm)	10	2

E Connecting Rod Kit for Large U System - Stainless Steel

MWI#	SECUROS#	DIAMETER	LENGTH (")	QTY.
028986	002202	3/16" (4.8mm)	6	2
028987	002203	3/16" (4.8mm)	8	2
028988	002204	3/16" (4.8mm)	10	2
028989	002205	3/16" (4.8mm)	12	2
028990	002206	3/16" (4.8mm)	14	2

Wrenches

A 1/4" x 5/16" Double Open Ended Wrench

MWI#	SECUROS#	QTY.
029020	001221	1

B Precision Torque Wrench with Socket

MWI#	SECUROS#	QTY.
031187	001222	1

Nut Drivers

A 1/4" Nut Driver for Small Systems

MWI#	SECUROS#	QTY.
■ 372102	001224	1

B 5/16" Nut Driver for Large Systems

MWI#	SECUROS#	QTY.
■ 372103	001225	1

Optional Items

MWI#	SECUROS#	DESCRIPTION	QTY.
033446	810004	General Surgery Pack	1
■	001231	2.4mm Extended Drill Sleeve	1
■ 370238	001233	3.2mm Extended Drill Sleeve	1
042055	000643	1.5mm Drill Bit - Quick Coupling	1
042090	001361	2.4mm Drill Bit - Quick Coupling	1
045544	001362	3.2mm Drill Bit - Quick Coupling	1
045559	000644	4.0mm Drill Bit - Quick Coupling	1
030031	002219	7" Fastfix Putty .25 oz.	1
045434	001331	Plastic Case with Silicone Mat, 20.75" x 10" x 2.5"	1
031093	001005	Perforated Tray - Stainless Steel, 12.25" x 7.75" x 2.25"	1

■ special order item



PIN & WIRE MANAGEMENT

Kirschner Wire (K-Wire)

Choose one of the following two options.



Steinmann/Intramedullary Pins

Choose one of the following four options.



Orthopedic Wire

Choose one of the following three options.

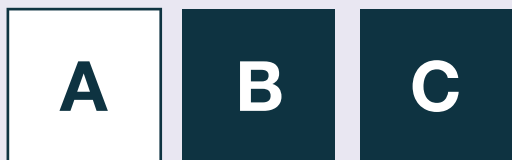

Instruments

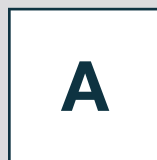

Optional Items

MWI#	SECUROS#	DESCRIPTION	QTY.
033446	810004	General Surgery Pack	1
029519	001480	Mini Dual Chuck Hand Chuck	1
045025	840391	Wire Twister TC 6"	1
043913	001704	Cerclage Wire Tightener 4.75"	1
043938	003542	Double Cerclage Wire Tightener 10"	1
045287	840372	Vise Grip Locking Pliers 7"	1
090071	840367	Needle Nose Locking Pliers 8.5"	1
045023	840380	Needle Nose Pliers 5.5"	1
043910	001469	3/32" Pin Punch	1
044007	001468	1/8" Pin Punch	1
044609	001470	5/32" Pin Punch	1
045293	840403	5/64" Side Pin Cutter 5.75"	1
045027	840404	7/64" Side Angled Pin Cutter 8.75"	1
036209	001458	1/4" Side Pin Cutter with Detachable Handles 18.5"	1
045292	840402	1/16" Cannulated Front Pin Cutter 7.5"	1
055140	840929	Universal K-Wire Bender	1
390152	002062	Double K-Wire Bender	1
031093	001005	Perforated Tray - Stainless Steel, 12.25" x 7.75" x 2.25"	1

PIN & WIRE MANAGEMENT

Kirschner Wire (K-Wire)

A 5" K-Wire Kit

MWI#	SECUROS#	DESCRIPTION	QTY.
049153	005330	0.028" x 5" K-Wire - Pack of 10	1
055110	004853	0.035" x 5" K-Wire - Pack of 10	1
055111	004854	0.043" x 5" K-Wire - Pack of 10	1
052747	004855	0.054" x 5" K-Wire - Pack of 10	1
055112	004856	0.062" x 5" K-Wire - Pack of 10	1

B 9" K-Wire Kit

MWI#	SECUROS#	DESCRIPTION	QTY.
055078	005331	0.028" x 9" K-Wire - Pack of 6	1
029089	001277	0.035" x 9" K-Wire - Pack of 6	1
029090	001278	0.045" x 9" K-Wire - Pack of 6	1
029091	001279	0.054" x 9" K-Wire - Pack of 6	1
029092	001280	0.062" x 9" K-Wire - Pack of 6	1

Orthopedic Wire

A Orthopedic Wire 1 oz. Spool Kit

MWI#	SECUROS#	DESCRIPTION	QTY.
029080	001267	22 Gauge 1 oz. Spool	1
029079	001266	20 Gauge 1 oz. Spool	1
029078	001265	18 Gauge 1 oz. Spool	1
029077	001264	16 Gauge 1 oz. Spool	1

B Orthopedic Wire 4 oz. Spool Kit

MWI#	SECUROS#	DESCRIPTION	QTY.
029086	001274	22 Gauge 4 oz. Spool	1
029085	001273	20 Gauge 4 oz. Spool	1
029084	001272	18 Gauge 4 oz. Spool	1
029083	001271	16 Gauge 4 oz. Spool	1

C Orthopedic Wire with Loop Kit

MWI#	SECUROS#	DESCRIPTION	QTY.
031000	002917	22 Gauge with Loop	1
030999	002982	20 Gauge with Loop	1
030998	002981	18 Gauge with Loop	1
030997	002980	16 Gauge with Loop	1

Instruments

A Pin & Wire Management Instrument Kit

MWI#	SECUROS#	DESCRIPTION	QTY.
029517	001479	Dual Chuck Hand Chuck	1
045515	840413	Cerclage Wire Passer Cannulated Double Ended Solid Handle 5.5"	1
045081	840390	Wire Twister with Holes 6.5"	1
056034	001461	Wire Twister TC 7"	1
045348	840371	Parallel Pliers with Wire Cutter 7"	1
042096	840406	5/64" Side Angled Pin Cutter 7"	1

■ special order item

Steinmann/Intramedullary Pins

A 4.5" Smooth Steinmann Pin Kit

MWI#	SECUROS#	DESCRIPTION	QTY.
044962	004270	1/16" x 4.5" Trocar Smooth Pin	2
031011	002986	5/64" x 4.5" Trocar Smooth Pin	2
048256	003587	3/32" x 4.5" Trocar Smooth Pin	2
■ 372087	005487	7/64" x 4.5" Trocar Smooth Pin	2
031003	003099	1/8" x 4.5" Trocar Smooth Pin	2

B 9" Smooth Steinmann Pin Kit

MWI#	SECUROS#	DESCRIPTION	QTY.
029057	001235	1/16" x 9" Trocar/Trocar Smooth Pin	2
029058	001236	5/64" x 9" Trocar/Trocar Smooth Pin	2
029059	001237	3/32" x 9" Trocar/Trocar Smooth Pin	2
029060	001238	7/64" x 9" Trocar/Trocar Smooth Pin	2
029061	001239	1/8" x 9" Trocar/Trocar Smooth Pin	2
029062	001240	9/64" x 9" Trocar/Trocar Smooth Pin	2
029063	001241	5/32" x 9" Trocar/Trocar Smooth Pin	2
029064	001242	3/16" x 9" Trocar/Trocar Smooth Pin	2

C 4.5" Partially Threaded Steinmann Pin Kit

MWI#	SECUROS#	DESCRIPTION	QTY.
042426	004271	1/16" x 4.5" Trocar Partially Threaded Pin	2
■ 372086	005485	5/64" x 4.5" Trocar Partially Threaded Pin	2
035918	003586	3/32" x 4.5" Trocar Partially Threaded Pin	2
■ 372088	005486	7/64" x 4.5" Trocar Partially Threaded Pin	2
031005	002985	1/8" x 4.5" Trocar Partially Threaded Pin	2

D 9" Partially Threaded Steinmann Pin Kit

MWI#	SECUROS#	DESCRIPTION	QTY.
029068	001257	1/16" x 9" Trocar/Trocar Partially Threaded Pin	2
029069	001258	5/64" x 9" Trocar/Trocar Partially Threaded Pin	2
029070	001259	3/32" x 9" Trocar/Trocar Partially Threaded Pin	2
029071	001260	7/64" x 9" Trocar/Trocar Partially Threaded Pin	2
029072	002956	1/8" x 9" Trocar/Trocar Partially Threaded Pin	2
029073	002957	9/64" x 9" Trocar/Trocar Partially Threaded Pin	2
029074	001261	5/32" x 9" Trocar/Trocar Partially Threaded Pin	2
029075	001262	3/16" x 9" Trocar/Trocar Partially Threaded Pin	2

CONVENTIONAL PLATE OSTEOSYNTHESIS: MINI FRAGMENT KITS

1.5mm Plates

Choose one of the following two options.



2.0mm Plates

Choose one of the following three options.



1.5mm Screws

Choose one of the following two options.



2.0mm Screws

Choose one of the following two options.



Bending Instruments

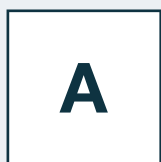

Drill Bits

Choose one of the following two options.



Drill Guides

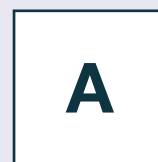

Depth Gauges



Screwdrivers

Choose one of the following four options.



CONVENTIONAL PLATE OSTEOSYNTHESIS: MINI FRAGMENT KITS

1.5mm Plates

A 1.5mm Round Hole Cut-to-Length Plate - 20 Holes

MWI#	SECUROS#	QTY.
042231	001852	1

B 1.5mm Dynamic Compression Plate Kit

MWI#	SECUROS#	# OF HOLES	QTY.
042228	001849	4	1
042229	001850	5	1
029133	001851	6	1
042406	003804	7	1
042407	003805	8	1

2.0mm Plates

A 2.0/2.4/2.7mm Round Hole Semi-Tubular Cut-to-Length Plate - 50 Holes

MWI#	SECUROS#	QTY.
042331	003475	1

B 2.0mm Dynamic Compression Plate Kit

MWI#	SECUROS#	# OF HOLES	QTY.
042321	003407	4	1
042322	003408	5	1
042323	003409	6	1
042326	003461	7	1
036202	003462	8	1

C 2.0mm Limited Contact Dynamic Compression Plate Kit

MWI#	SECUROS#	# OF HOLES	QTY.
046850	003951	4	1
046870	003952	5	1
044015	003953	6	1
044017	003954	7	1
044018	003955	8	1

1.5mm Screws

A 1.5mm Cortical Screw, Self-Tapping, Cruciform Recess Kit - Stainless Steel

MWI#	SECUROS#	LENGTH (mm)	QTY.
042141	100026	6	4
042125	100000	7	4
042126	100001	8	4
042127	100002	9	4
042128	100003	10	4
042142	100027	11	4
042129	100004	12	4
042130	100005	14	2
042131	100006	16	2

B 1.5mm Cortical Screw, Self-Tapping, Hexagonal Recess Kit - Stainless Steel

MWI#	SECUROS#	LENGTH (mm)	QTY.
029121	001835	6	4
029122	001836	7	4
029123	001837	8	4
029124	001839	9	4
029125	001840	10	4
031110	002529	11	4
029126	001841	12	4
029127	001842	14	2
029128	001843	16	2

2.0mm Screws

A 2.0mm Cortical Screw, Self-Tapping, Cruciform Recess Kit - Stainless Steel

MWI#	SECUROS#	LENGTH (mm)	QTY.
042132	100009	6	4
042133	100010	8	4
042134	100011	10	4
042140	100022	12	4
042135	100012	14	4
042136	100013	16	4
042137	100014	18	2
042138	100016	20	2

B 2.0mm Cortical Screw, Self-Tapping, Hexagonal Recess Kit - Stainless Steel

MWI#	SECUROS#	LENGTH (mm)	QTY.
029135	001853	6	4
029136	001854	8	4
029137	001855	10	4
029138	001856	12	4
029139	001857	14	4
029140	001858	16	4
029141	001859	18	2
029142	001860	20	2

Continued →

CONVENTIONAL PLATE OSTEOSYNTHESIS: MINI FRAGMENT KITS

Bending Instruments

A 1.5/2.0mm Bending Iron

MWI#	SECUROS#	QTY.
042253	002056	2

Drill Guides

A Double Drill Guide Kit for 1.5/2.0mm Conventional Bone Plates

MWI#	SECUROS#	DESCRIPTION	QTY.
030971	002066	1.1/1.5mm Double Drill Guide	1
030970	002067	1.5/2.0mm Double Drill Guide	1

Depth Gauges

A 1.5/2.0/2.4mm Depth Gauge

MWI#	SECUROS#	QTY.
029097	002049	1

Optional Items

MWI#	SECUROS#	DESCRIPTION	QTY.
029016	001902	2.0mm Compressional Drill Guide	1
■ 372175	001900	2.0mm Parallel Drill Guide & Drill Sleeve	1
029097	002049	1.5/2.0/2.4mm Depth Gauge	1
043934	001912	1.5/2.0mm Countersink	1
043901	000402	2.0mm Plate Stringer	1
044068	002320	Screw Rack for 1.5/2.0/2.7mm Cortical Screws	1
045549	000882	Screw Rack for 1.5/2.0mm Cortical Screws	1
056009	003750	Screw Rack for 2.0/2.7/3.5mm Cortical Screws	1
056017	002872	Small Red Fragment Instrument Case - Aluminum	1
■ 388988	005094	Standard Screw Reference - Stainless Steel	1
■ 388989	005095	Standard Screw Reference - Titanium	1
■ 388990	004939	Washer Reference	1

■ special order item

Drill Bits

A Jacobs Chuck Coupling Drill Bit Kit (BITE Bit, Titanium Nitride Coated)

MWI#	SECUROS#	DIAMETER (mm)	QTY.
028993	002034	1.1	2
028994	002035	1.5	2
028995	002036	2.0	2

B Quick Coupling Drill Bit Kit (BITE Bit, Titanium Nitride Coated)

MWI#	SECUROS#	DIAMETER (mm)	QTY.
029008	002043	1.1	2
029009	002044	1.5	2
029010	001018	2.0	2

Screwdrivers

A 1.5/2.0/2.4mm Cruciform Screwdriver (Includes Holding Sleeve)

MWI#	SECUROS#	QTY.
042073	001026	1

B 1.5/2.0mm Hexagonal Screwdriver (Includes holding sleeve)

MWI#	SECUROS#	QTY.
042292	002504	1

C Screwdriver Shaft & Handle Kit (Includes holding sleeve)

MWI#	SECUROS#	DESCRIPTION	QTY.
056007	003827	1.5/2.0/2.4mm Cruciform Screwdriver Shaft	1
042033	000123	Mini Handle	1

D Screwdriver Shaft & Handle Kit (Includes holding sleeve)

MWI#	SECUROS#	DESCRIPTION	QTY.
055058	004660	1.5/2.0mm Hexagonal Screwdriver Shaft	1
042033	000123	Mini Handle	1



CONVENTIONAL PLATE OSTEOSYNTHESIS: 2.4mm KITS

2.4mm Plates

Choose one of the following three options.



2.4mm Screws

Choose one of the following two options.



Bending Instruments



Drill Bits

Choose one of the following two options.



Drill Guides

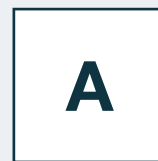

Depth Gauges



Screwdrivers

Choose one of the following four options.



Optional Items

MWI#	SECUROS#	DESCRIPTION	QTY.
029528	001916	Large Handle	1
052748	007180	Silicone Handle	1
042069	000883	Screw Rack for 2.4/2.7/3.5mm Cortical Screws	1
056017	002872	Small Red Fragment Instrument Case - Aluminum	1
■ 388988	005094	Standard Screw Reference - Stainless Steel	1
■ 388989	005095	Standard Screw Reference - Titanium	1
■ 388990	004939	Washer Reference	1

■ special order item

CONVENTIONAL PLATE OSTEOSYNTHESIS: 2.4mm KITS

2.4mm Plates

A 2.0/2.4/2.7mm Round Hole Semi-Tubular Cut-to-Length Plate - 50 Hole

MWI#	SECUROS#	QTY.
042331	003475	1

B 2.4mm Dynamic Compression Plate Kit

MWI#	SECUROS#	# OF HOLES	QTY.
049089	004979	5	1
049090	004980	6	1
049091	004981	7	1
049092	004982	8	1
049093	004983	9	1

C 2.4mm Limited Contact Dynamic Compression Plate Kit

MWI#	SECUROS#	# OF HOLES	QTY.
042334	003628	5	1
042335	003629	6	1
044022	003630	7	1
044023	003631	8	1
044024	003819	9	1

Bending Instruments

A Bending Instrument Kit for 2.4/2.7/3.5mm Conventional Bone Plates

MWI#	SECUROS#	DESCRIPTION	QTY.
029100	002057	2.4/2.7/3.5mm Bending Iron Left	1
029101	002058	2.4/2.7/3.5mm Bending Iron Right	1

Screwdrivers

A 1.5/2.0/2.4mm Cruciform Screwdriver (Includes holding sleeve)

MWI#	SECUROS#	QTY.
042073	001026	1

B 2.4mm Hexagonal Screwdriver (Includes holding sleeve)

MWI#	SECUROS#	QTY.
035880	003237	1

C 1.5/2.0/2.4mm Cruciform Quick Coupling Screwdriver Shaft & Handle Kit (Includes holding sleeve)

MWI#	SECUROS#	DESCRIPTION	QTY.
056007	003827	1.5/2.0/2.4mm Cruciform Screwdriver Shaft	1
042033	000123	Mini Handle	1

D 2.4mm Hexagonal Quick Coupling Screwdriver Shaft & Handle Kit (Includes holding sleeve)

MWI#	SECUROS#	DESCRIPTION	QTY.
055102	003904	2.4mm Hexagonal Screwdriver Shaft	1
029529	007003	Small Handle	1

Depth Gauges

A 1.5/2.0/2.4mm Depth Gauge

MWI#	SECUROS#	QTY.
029097	002049	1

2.4mm Screws

A 2.4mm Cortical Screw, Self-Tapping, Cruciform Recess Kit - Stainless Steel

MWI#	SECUROS#	LENGTH (mm)	QTY.
047231	100099	10	4
047233	100101	12	4
047235	100103	14	4
047236	100104	16	4
047237	100105	18	4
047238	100106	20	4
047239	100107	22	4
047240	100108	24	4
047241	100109	26	4
047242	100110	28	4
047243	100111	30	4
047244	100112	32	4
047245	100113	34	4
047246	100114	36	4
047247	100115	38	4
047248	100116	40	4

B 2.4mm Cortical Screw, Self-Tapping, Hexagonal Recess Kit - Stainless Steel

MWI#	SECUROS#	LENGTH (mm)	QTY.
030982	001027	10	4
030983	001028	12	4
030984	001029	14	4
030985	001030	16	4
030986	001031	18	4
030987	001032	20	4
030980	001033	22	4
030988	001034	24	4
030989	001035	26	4
030981	001036	28	4
030990	001037	30	4
030991	001038	32	4
030992	001039	34	4
030993	001040	36	4
030994	001041	38	4
030995	001042	40	4

Drill Bits

A Jacobs Chuck Coupling Drill Bit Kit (BITE Bit, Titanium Nitride Coated)

MWI#	SECUROS#	DIAMETER (mm)	QTY.
031139	001017	1.8	2
031129	001358	2.4	2

B Quick Coupling Drill Bit Kit (BITE Bit, Titanium Nitride Coated)

MWI#	SECUROS#	DIAMETER (mm)	QTY.
036059	000395	1.8	2
042090	001361	2.4	2

Drill Guides

A 1.8/2.4mm Double Drill Guide

MWI#	SECUROS#	QTY.
055050	003824	1

CONVENTIONAL PLATE OSTEOSYNTHESIS: SMALL FRAGMENT KITS

2.7mm Plates

Choose one of the following three options.



3.5mm Plates

Choose one of the following six options.

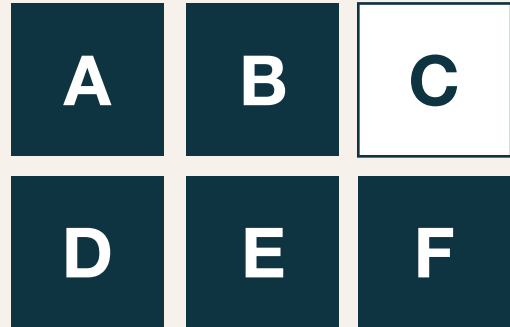

2.7mm Screws



3.5mm Screws

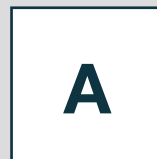

4.0mm Screws

Choose one of the following two options.



Bending Instruments



Drill Bits

Choose one of the following two options.



Taps

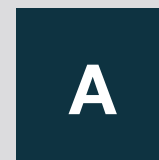

Drill Guides

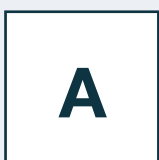

Depth Gauges



Screwdrivers

Choose one of the following two options.



CONVENTIONAL PLATE OSTEOSYNTHESIS: SMALL FRAGMENT KITS

2.7mm Plates

A 2.0/2.4/2.7mm Round Hole Semi-Tubular Cut-to-Length Plate - 50 Holes

MWI#	SECUROS#	QTY.
042331	003475	1

B 2.7mm Dynamic Compression Plate Kit

MWI#	SECUROS#	# OF HOLES	QTY.
029191	001649	5	1
029192	001650	6	1
029193	001651	7	1
029194	001652	8	1
042218	001653	9	1

C 2.7mm Limited Contact Dynamic Compression Plate Kit

MWI#	SECUROS#	# OF HOLES	QTY.
042213	001640	5	1
029183	001641	6	1
029184	001642	7	1
029185	001643	8	1
042214	001644	9	1

3.5mm Plates

A 3.5mm Narrow Round Hole Lengthening Plate Kit

MWI#	SECUROS#	# OF HOLES	QTY.
048229	004084	6	1
044937	004085	7	1
045166	003588	8	1
048230	004087	9	1
052745	004088	10	1

B 3.5mm Broad Round Hole Lengthening Plate Kit

MWI#	SECUROS#	# OF HOLES	QTY.
048196	003495	6	1
045490	003496	7	1
045632	003497	8	1
044931	003498	9	1
052746	003499	10	1

C 3.5mm Narrow Dynamic Compression Plate Kit

MWI#	SECUROS#	# OF HOLES	QTY.
042261	002112	5 Holes	1
029228	002113	6 Holes	1
029229	002114	7 Holes	1
029230	002115	8 Holes	1
029231	002119	9 Holes	1
029232	002117	10 Holes	1

D 3.5mm Broad Dynamic Compression Plate Kit

MWI#	SECUROS#	# OF HOLES	QTY.
029235	002120	7	1
029236	002121	8	1
029237	002122	9	1
029238	002123	10	1
029239	002124	11	1
042264	002125	12	1

E 3.5mm Narrow Limited Contact Dynamic Compression Plate Kit

MWI#	SECUROS#	# OF HOLES	QTY.
042255	002103	5	1
029219	002104	6	1
029220	002105	7	1
029221	002106	8	1
042256	002107	9	1
042257	002108	10	1

F 3.5mm Broad Limited Contact Dynamic Compression Plate Kit

MWI#	SECUROS#	# OF HOLES	QTY.
045172	003643	7	1
046920	003644	8	1
044302	003645	9	1
046790	003646	10	1
048495	003647	11	1
044030	003648	12	1

Continued →

CONVENTIONAL PLATE OSTEOSYNTHESIS: SMALL FRAGMENT

2.7mm Screws

A 2.7mm Cortical Screw, Self-Tapping, Hexagonal Recess Kit - Stainless Steel

MWI#	SECUROS#	LENGTH (mm)	QTY.
029167	001879	10	4
029168	001880	12	4
029169	001881	14	4
029170	001882	16	4
029171	001883	18	4
029172	001630	20	4
029173	001631	22	4
029174	001632	24	4
029175	001633	26	4
029176	001634	28	4
029177	001635	30	4

3.5mm Screws

A 3.5mm Cortical Screw, Self-Tapping, Hexagonal Recess Kit - Stainless Steel

MWI#	SECUROS#	LENGTH (mm)	QTY.
029201	001886	12	4
029202	001887	14	4
029203	001888	16	4
029204	001889	18	4
029205	001890	20	4
029207	001891	22	4
029208	001892	24	4
029209	001893	26	4
029210	001894	28	4
029211	001895	30	4
029212	001896	32	4
029213	001897	34	4
029214	001898	36	4
029215	001899	38	4

4.0mm Screws

A 4.0mm Cancellous Screw, Fully Threaded, Hexagonal Recess Kit - Stainless Steel

MWI#	SECUROS#	LENGTH (mm)	QTY.
■ 372047	000445	18	2
048501	000446	20	2
■ 372048	000447	22	2
046112	000448	24	2
■ 372049	000449	26	2
■ 372172	000450	28	2
■ 372173	000451	30	2
042045	000452	32	2
■ 372050	000453	34	2
■ 372051	000454	36	2
■ 372052	000455	38	2
■ 372174	000456	40	2

B 4.0mm Cancellous Screw, Fully Threaded, Fat Neck, Hexagonal Recess Kit - Stainless Steel

MWI#	SECUROS#	LENGTH (mm)	QTY.
029419	001583	18	2
029420	001584	20	2
029421	001585	22	2
029422	001586	24	2
029423	001587	26	2
029424	001588	28	2
029425	001589	30	2
029426	001590	32	2
029427	001591	34	2
029428	001592	36	2
029429	001593	38	2
029430	001594	40	2

Bending Instruments

A Bending Instrument Kit for 2.4/2.7/3.5mm Conventional Bone Plates

MWI#	SECUROS#	DESCRIPTION	QTY.
029100	002057	2.4/2.7/3.5mm Bending Iron Left	1
029101	002058	2.4/2.7/3.5mm Bending Iron Right	1

Drill Bits

A Jacobs Chuck Coupling Drill Bit Kit (BITE Bit, Titanium Nitride Coated)

MWI#	SECUROS#	DIAMETER (mm)	QTY.
028995	002036	2.0	2
028997	002038	2.7	2
028996	002037	2.5	2
029005	002040	3.5	2
029006	002041	4.0	2

B Quick Coupling Drill Bit Kit (BITE Bit, Titanium Nitride Coated)

MWI#	SECUROS#	DIAMETER (mm)	QTY.
029010	001018	2.0	2
029012	002045	2.7	2
029011	001019	2.5	2
029014	002047	3.5	2
042034	000366	4.0	2

Depth Gauges

A 2.7/3.5/4.0mm Depth Gauge

MWI#	SECUROS#	QTY.
029098	001020	1

Screwdrivers

A 2.7/3.5/4.0mm Hexagonal Screwdriver (Includes holding sleeve)

MWI#	SECUROS#	QTY.
029524	001024	1

B 2.7/3.5/4.0mm Hexagonal Quick Coupling Screwdriver Shaft & Handle Kit (Includes holding sleeve)

MWI#	SECUROS#	DESCRIPTION	QTY.
029525	001025	2.7/3.5/4.0mm Hexagonal Screwdriver Shaft	1
029529	007003	Small Handle	1

Taps

A 4.0mm Quick Coupling Cancellous Tap Kit

MWI#	SECUROS#	DESCRIPTION	QTY.
042241	001911	4.0mm Cancellous QC Tap	1
029530	001918	T-Handle	1

CONVENTIONAL PLATE OSTEOSYNTHESIS: SMALL FRAGMENT

Drill Guides

A Double Drill Guide Kit for 2.7/3.5mm Conventional Bone Plates

MWI#	SECUROS#	DESCRIPTION	QTY.
031195	001022	2.0/2.7mm Double Drill Guide	1
030996	001023	2.5/3.5mm Double Drill Guide	1

Optional Items

MWI#	SECUROS#	DESCRIPTION	QTY.
042238	001903	2.7mm Compressional Drill Guide	1
029018	001904	3.5mm Compressional Drill Guide	1
042267	002279	3.5mm Universal Drill Guide	1
029528	001916	Large Handle	1
052748	007180	Silicone Handle	1
045109	001901	2.5/3.5mm Insert Drill Sleeve	1
043906	001913	2.7mm Countersink	1
043909	001914	3.5mm Countersink	1
045448	002051	3.5mm Bending Template 7 Holes	1
045125	002052	3.5mm Bending Template 9 Holes	1
055169	002059	2.0/2.4/2.7mm Small Bending Pliers	1
045449	002063	2.7/3.5mm Medium Bending Pliers	1
044054	002064	2.7/3.5/4.5mm Large Bending Pliers	1
045227	003891	Small Table Top Bending Press for use with Plates up to 3.5mm Broad	1
043903	000401	2.7mm Plate Stringer	1
043908	000400	3.5mm Plate Stringer	1
042069	000883	Screw Rack for 2.4/2.7/3.5mm Cortical Screws	1
044068	002320	Screw Rack for 1.5/2.0/2.7mm Cortical Screws	1
056009	003750	Screw Rack for 2.0/2.7/3.5mm Cortical Screws	1
042069	000883	Screw Rack for 2.4/2.7/3.5mm Cortical Screws	1
045560	000881	Screw Rack for 2.7/3.5mm Cortical & 4.0mm Cancellous Screws	1
045628	003289	Screw Rack for 3.5/4.5mm Cortical Screws	1
045476	002997	Screw Rack for 3.5mm Cortical & 4.0mm Cancellous Screws	1
056017	002872	Small Red Fragment Instrument Case - Aluminum	1
■ 388988	005094	Standard Screw Reference - Stainless Steel	1
■ 388989	005095	Standard Screw Reference - Titanium	1
■ 388990	004939	Washer Reference	1

CONVENTIONAL PLATE OSTEOSYNTHESIS: 4.5mm KITS

4.5mm Plates

Choose one of the following two options.



4.5mm Screws



Bending Instruments



Drill Bits

Choose one of the following two options.



Drill Guides



Depth Gauges



Screwdrivers

Choose one of the following two options.



Optional Items

MWI#	SECUROS#	DESCRIPTION	QTY.
048538	001905	4.5mm Compressional Drill Guide	1
029528	001916	Large Handle	1
052748	007180	Silicone Handle	1
045212	001915	4.5mm Countersink	1
045610	002053	4.5mm Bending Template 9 Holes	1
045611	002055	4.5mm Bending Template 11 Holes	1
044054	002064	Large Bending Pliers for use with 2.7/3.5/4.5mm Plates	1
■	002065	Table Top Bending Press for use with Plates up to 4.5mm Broad	1
045628	003289	Screw Rack for 3.5/4.5mm Cortical Screws	1
055085	000885	Screw Rack for 4.5mm Cortical Screws	1
048564	002315	Screw Rack for 4.5mm Cortical & 6.5mm Cancellous Screws	1
056017	002872	Small Red Fragment Instrument Case - Aluminum	1
■	388988	Standard Screw Reference - Stainless Steel	1
■	388989	Standard Screw Reference - Titanium	1
■	388990	Washer Reference	1

■ special order item

CONVENTIONAL PLATE OSTEOSYNTHESIS: 4.5mm KITS

4.5mm Plates

A 4.5mm Narrow Dynamic Compression Plate Kit

MWI#	SECUROS#	# OF HOLES	QTY.
029249	002134	4	1
029250	002135	5	1
029251	002136	6	1
042266	002137	7	1
029253	002138	8	1
029254	002139	9	1
029255	002140	10	1
029256	002141	11	1
029257	002142	12	1

B 4.5mm Broad Dynamic Compression Plate Kit

MWI#	SECUROS#	# OF HOLES	QTY.
029266	002151	6	1
048554	002152	7	1
029268	002153	8	1
029269	002154	9	1
029270	002155	10	1
029271	002156	12	1
029272	002157	14	1

4.5mm Screws

A 4.5mm Cortical Screw Self-Tapping, Hexagonal Recess Kit - Stainless Steel

MWI#	SECUROS#	LENGTH (mm)	QTY.
029284	001529	20	4
029285	001530	22	4
029286	001531	24	4
029287	001532	26	4
029288	001533	28	4
029289	001534	30	4
029290	001535	32	4
029291	001536	34	4
029292	001537	36	4
029293	001538	38	4
029294	001539	40	4
029295	001540	42	4
042202	001541	44	4
029297	001542	46	4
042203	001543	48	4
042204	001544	50	4
042205	001545	52	4
029384	001546	54	4

Bending Instruments

A Bending Instrument Kit

MWI#	SECUROS#	DESCRIPTION	QTY.
042314	002948	Bending Iron for Large Standard Plates	2

Drill Bits

A Jacobs Chuck Coupling Drill Bit Kit (BITE Bit, Titanium Nitride Coated)

MWI#	SECUROS#	DIAMETER (mm)	QTY.
028998	002039	3.2	2
042251	002042	4.5	2

B Quick Coupling Drill Bit Kit (BITE Bit, Titanium Nitride Coated)

MWI#	SECUROS#	DIAMETER (mm)	QTY.
042252	002046	3.2	2
029015	002048	4.5	2

Drill Guides

A 3.2/4.5mm Double Drill Guide

MWI#	SECUROS#	QTY.
031201	002278	1

Screwdrivers

A 4.5/5.5/6.5mm Hexagonal Screwdriver (Includes holding sleeve)

MWI#	SECUROS#	QTY.
029526	001920	1

B 4.5/5.5/6.5mm Hexagonal Quick Coupling Screwdriver Shaft & Handle Kit (Includes holding sleeve)

MWI#	SECUROS#	DESCRIPTION	QTY.
029527	001921	4.5/5.5/6.5mm Hexagonal Screwdriver Shaft	1
029529	007003	Small Handle	1

Depth Gauges

A 4.5/5.5/6.5mm Depth Gauge

MWI#	SECUROS#	QTY.
029099	002050	1

CONVENTIONAL PLATE OSTEOSYNTHESIS: 5.5mm KITS

5.5mm Screws



Drill Bits



Depth Gauges

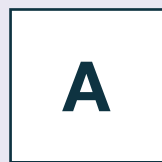

Screwdrivers

Choose one of the following two options.



Taps



CONVENTIONAL PLATE OSTEOSYNTHESIS: 5.5mm KITS

5.5mm Screws

A 5.5mm Cortical Screw Self-Tapping, Hexagonal Recess Kit - Stainless Steel

MWI#	SECUROS#	LENGTH (mm)	QTY.
■ 370062	005259	28	4
■ 370063	005260	30	4
049455	005261	32	4
■ 370064	005262	34	4
■ 370065	005263	36	4
■ 370066	005264	38	4
■ 370067	005265	40	4
■ 370068	005266	42	4
■ 370069	005267	44	4
■ 370070	005268	46	4
■ 370071	005269	48	4
■ 370072	005270	50	4
049456	005271	52	4
■ 370073	005272	54	4
■ 370074	005273	56	4
■ 370075	005274	58	4
■ 370076	005275	60	4
■ 370077	005276	65	4
■ 370078	005277	70	4
■ 370079	005278	80	4
049457	005279	90	1
048394	005280	100	1

Drill Bits

A Quick Coupling Drill Bit Kit (BITE Bit, Titanium Nitride Coated)

MWI#	SECUROS#	DIAMETER (mm)	QTY.
042034	000366	4.0	2
048102	000367	5.5	2

Depth Gauges

A 4.5/5.5/6.5mm Depth Gauge

MWI#	SECUROS#	QTY.
029099	002050	1

Optional Items

MWI#	SECUROS#	DESCRIPTION	QTY.
055086	000905	5.5mm Universal Drill Guide	1
045099	000904	4.0/5.5mm Insert Drill Sleeve	1
045392	000368	5.5mm Tap Sleeve	1
029528	001916	Large Handle	1
052748	007180	Silicone Handle	1
055101	003752	Screw Rack for 5.5mm Cortical Screws	1
042039	000418	Internal Fixation Organizer Case - Blue Cover w/ Logo	1
056017	002872	Small Red Fragment Instrument Case - Aluminum	1
■ 388988	005094	Standard Screw Reference - Stainless Steel	1
■ 388989	005095	Standard Screw Reference - Titanium	1
■ 388990	004939	Washer Reference	1
■ special order item			

Screwdrivers

A 4.5/5.5/6.5mm Hexagonal Screwdriver (Includes holding sleeve)

MWI#	SECUROS#	QTY.
029526	001920	1

B 4.5/5.5/6.5mm Hexagonal Quick Coupling Screwdriver Shaft & Handle Kit (Includes holding sleeve)

MWI#	SECUROS#	DESCRIPTION	QTY.
029527	001921	4.5/5.5/6.5mm Hexagonal Screwdriver Shaft	1
029529	007003	Small Handle	1

Taps

A 5.5mm Quick Coupling Cortical Tap Kit

MWI#	SECUROS#	DESCRIPTION	QTY.
045135	002500	5.5mm Cortical QC Tap	1
029530	001918	T-Handle	1

LOCKED PLATE OSTEOSYNTHESIS: MINI FRAGMENT KITS

2.0mm PAX Locking Plates

Choose one of the following three options.



2.4mm PAX Locking Plates

Choose one of the following three options.



2.0mm PAX Locking Screws



2.4mm PAX Locking Screws



Drill Bits



Drill Guides



Screwdrivers



Optional Items

MWI#	SECUROS#	DESCRIPTION	QTY.
042389	007006	PAX Plate Holding Forceps	1
051986	007175	2.0mm PAX Neutral/Load (Compressional) Drill Guide	1
051987	007176	2.4mm PAX Neutral/Load (Compressional) Drill Guide	1
029528	001916	Large Handle	1
052748	007180	Silicone Handle	1

LOCKED PLATE OSTEOSYNTHESIS: MINI FRAGMENT KITS

2.0mm PAX Locking Plates

A 2.0mm Locking Reconstruction Plate (RP) Kit - Titanium (Light Blue)

MWI#	SECUROS#	# OF HOLES	QTY.
042171	007011	4	1
042173	007012	5	1
042174	007013	6	1
042175	007014	7	1
042176	007015	8	1
042178	007016	9	1

B 2.0mm Locking Limited Contact Straight Plate (SP) Kit - Titanium (Light Blue)

MWI#	SECUROS#	# OF HOLES	QTY.
049587	007150	5	1
049588	007151	6	1
049589	007152	7	1
049590	007153	8	1
049591	007154	9	1

C 2.0mm Locking T- Plate (RP) Kit - Titanium (Light Blue)

MWI#	SECUROS#	# OF HOLES	QTY.
042185	007028	2 Head, 3 Shaft	1
042186	007029	2 Head, 4 Shaft	1
042187	007030	2 Head, 5 Shaft	1
042188	007031	2 Head, 6 Shaft	1

2.0mm PAX Locking Screws

A 2.0mm Locking Screw, Self-Tapping, T6 Stardrive Recess Kit, Titanium (Light Blue)

MWI#	SECUROS#	LENGTH (mm)	QTY.
042190	007039	6	5
042191	007040	8	5
042192	007041	10	5
042193	007042	12	5
042194	007043	14	5
042195	007044	16	5
042196	007045	18	2
042197	007046	20	2

Drill Bits

A Quick Coupling Drill Bit Kit (BITE Bit, Titanium Nitride Coated)

MWI#	SECUROS#	DIAMETER (mm)	QTY.
042390	007007	1.3	2
042391	007008	1.7	2

Drill Guides

A 2.0/2.4mm PAX Double Drill Guide

MWI#	SECUROS#	QTY.
042388	007005	1

2.4mm PAX Locking Plates

A 2.4mm Locking Reconstruction Plate (RP) Kit - Titanium (Copper)

MWI#	SECUROS#	# OF HOLES	QTY.
042181	007020	6	1
044627	007021	7	1
042182	007022	8	1
042183	007023	9	1
044623	007024	10	1
044624	007025	12	1

B 2.4mm Locking Limited Contact Straight Plate (SP) Kit - Titanium (Copper)

MWI#	SECUROS#	# OF HOLES	QTY.
049597	007161	6	1
049598	007162	7	1
049599	007163	8	1
049600	007164	9	1
049601	007165	10	1
049602	007166	12	1

C 2.4mm Locking T- Plate (RP) Kit - Titanium (Copper)

MWI#	SECUROS#	# OF HOLES	QTY.
044629	007034	2 Head, 3 Shaft	1
044630	007035	2 Head, 4 Shaft	1
044631	007036	2 Head, 5 Shaft	1
044632	007037	2 Head, 6 Shaft	1

2.4mm PAX Locking Screws

A 2.4mm Locking Screw, Self-Tapping, T6 Stardrive Recess Kit - Titanium (Copper)

MWI#	SECUROS#	LENGTH (mm)	QTY.
042198	007047	6	5
042199	007048	8	5
042337	007049	10	5
042342	007050	12	5
042343	007051	14	5
042344	007052	16	5
042346	007053	18	5
042348	007054	20	2
042349	007055	22	2
042350	007056	24	2

Screwdrivers

A 2.0/2.4mm PAX Quick Coupling Screwdriver Kit

MWI#	SECUROS#	DESCRIPTION	QTY.
042387	007004	T6 Stardrive Screwdriver Shaft for use with 2.0/2.4mm PAX Screws	1
029529	007003	Small Handle	1

LOCKED PLATE OSTEOSYNTHESIS: SMALL FRAGMENT KITS

2.7mm PAX Locking Plates

Choose one of the following two options.



3.5mm PAX Locking Plates

Choose one of the following two options.



2.7mm PAX Locking Screws



3.5mm PAX Locking Screws

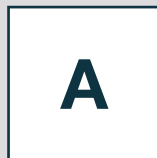

Drill Bits



Drill Guides



Screwdrivers



Optional Items

MWI#	SECUROS#	DESCRIPTION	QTY.
042389	007006	PAX Plate Holding Forceps	1
051988	007177	2.7mm PAX Neutral/Load (Compressional) Drill Guide	1
051989	007178	3.5mm PAX Neutral/Load (Compressional) Drill Guide	1
029528	001916	Large Handle	1
052748	007180	Silicone Handle	1

LOCKED PLATE OSTEOSYNTHESIS: SMALL FRAGMENT KITS

2.7mm PAX Locking Plates

A 2.7mm Locking Reconstruction Plate (RP) Kit - Titanium (Blue)

MWI#	SECUROS#	LENGTH (mm)	QTY.
044641	002806	6	1
044642	002807	7	1
042306	002808	8	1
044643	002809	9	1
044634	002810	10	1
044635	002812	12	1

B 2.7mm Locking Limited Contact Straight Plate (SP) Kit - Titanium (Blue)

MWI#	SECUROS#	LENGTH (mm)	QTY.
044945	004524	6	1
044946	004525	7	1
044947	004526	8	1
044948	004527	9	1
044949	004528	10	1
044899	004529	12	1

2.7mm PAX Locking Screws

A 2.7mm Locking Screw, Self-Tapping, T15 Stardrive Recess Kit - Titanium (Blue)

MWI#	SECUROS#	LENGTH (mm)	QTY.
042280	002486	10	5
042281	002487	12	5
042282	002488	14	5
042283	002489	16	5
042284	002490	18	5
042285	002491	20	5
042286	002492	22	5
042287	002493	24	5
042288	002494	26	5
042289	002495	28	5

Drill Bits

A Quick Coupling Drill Bit Kit (BITE Bit, Titanium Nitride Coated)

MWI#	SECUROS#	DIAMETER (mm)	QTY.
029010	001018	2.0	2
029011	001019	2.5	2

Drill Guides

A 2.7/3.5mm PAX Double Drill Guide

MWI#	SECUROS#	QTY.
042354	007062	1

3.5mm PAX Locking Plates

A 3.5mm Locking Reconstruction Plate (RP) Kit - Titanium (Gold)

MWI#	SECUROS#	LENGTH (mm)	QTY.
042245	001943	6	1
044657	001944	7	1
042246	001945	8	1
044658	001946	9	1
042247	001947	10	1
044650	001948	11	1
044651	001949	12	1

B 3.5mm Locking Limited Contact Straight Plate (SP) Kit - Titanium (Gold)

MWI#	SECUROS#	LENGTH (mm)	QTY.
045531	004509	6	1
044942	004510	7	1
045556	004511	8	1
045199	004512	9	1
045060	004513	10	1
045200	004514	11	1
055056	004515	12	1

3.5mm PAX Locking Screws

A 3.5mm Locking Screw, Self-Tapping, T15 Stardrive Recess Kit - Titanium (Gold)

MWI#	SECUROS#	LENGTH (mm)	QTY.
042359	007083	12	5
042361	007084	14	5
042364	007085	16	5
042366	007086	18	5
042368	007087	20	5
042369	007088	22	5
044659	007089	24	5
042100	007090	26	5
042105	007091	28	5
042106	007092	30	5
042107	007093	32	5
042108	007094	34	5
042109	007095	36	5
042111	007096	38	5

Screwdrivers

A 2.7/3.5mm PAX Quick Coupling Screwdriver Kit

MWI#	SECUROS#	DESCRIPTION	QTY.
042353	007061	T15 Stardrive Screwdriver Shaft for use with 2.7/3.5mm PAX Screws	1
029529	007003	Small Handle	1

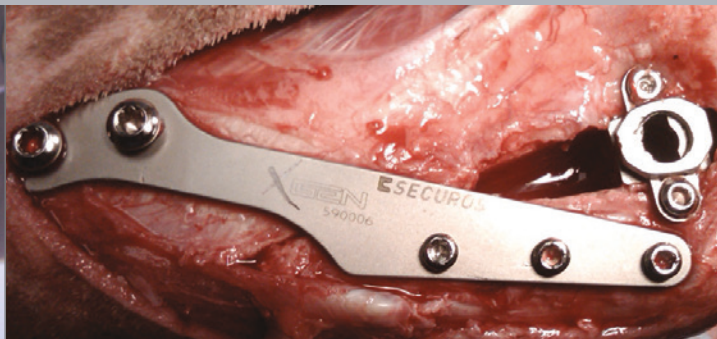

Radiograph provided by Veterinary Specialty Hospital—San Diego, CA

Stifle

Extracapsular Stabilization

Introduction	52
Implants	56
Swaged-on Suture.....	56
Suture Spools.....	59
Suture Needles.....	59
Crimp Clamps	60
Monofilament Nylon & Crimp Clamp Packs ..	60
Bone Anchors	61
Instruments	63
Instruments for Extracapsular Stabilization	63
Drill Bits	64
Hand Chucks	64
Steinmann/Intramedullary Pins	64
Power Equipment	65
Battery Powered Drill	65
Sterilization Containers.....	65
Sterilization Trays.....	65
Organizer Bags	66
Reference Materials	67

Tibial Tuberosity Advancement

Introduction	68
Implants	70
Standard Cages	70
Cut-to-Length Cages	72
XGEN TTA Plates	75
Standard TTA Plates.....	78
TTA Forks	80
Screws.....	81
Patella Luxation Spacers	85
Velocity Bone Graft.....	85
Instruments	86
Instruments for TTA	86
Drill Bits	87
Drill Guides	87
Depth Gauges	88
Screwdrivers, Handles & Shafts.....	88

Stifle

Bone Reduction Forceps.....	90
TTA Cage Cutter	90
Instruments for Standard TTA Plates	91
Sterilization Containers.....	92
Reference Materials	93

Tibial Plateau Leveling Osteotomy

Introduction	94
Implants	96
TPLO Plates	96
Screws.....	98
Bending Instruments	102
Drill Bits	104
Drill Guides	104
Depth Gauges	105
Screwdrivers, Handles, Shafts & Taps.....	105
TPLO Jig & Pins.....	108
Pin/Wire Cutters.....	109
Osteotomes	110
Mallets.....	110
Power Equipment	112
TPLO Saws & Accessories.....	112
TPLO Blades	114
Sterilization Containers.....	116
Reference Materials	117

Meniscal Management

Introduction	118
Instruments	119
Blade Handles & Blades.....	119
Retractors.....	119
Probes & Hooks	122
Forceps and Rongeurs.....	122
Sterilization Containers.....	123

ORTHOPEDIC Joint Management

Stifle	Patellar Luxation			
	Introduction	124		
	Implants	125		
	Pins & Wires	125		
	Instruments	126		
	Patellar Luxation Saw & Accessories	126		
	Osteotomes	126		
	Mallets	127		
	Rasps	127		
	Rongeurs	128		
	Bone Cutting Forceps	129		
	Hand Chucks	129		
	Wire Benders	130		
	Pin/Wire Cutters	130		
	Sterilization Containers	131		
	Hip	Coxofemoral Luxation Management		
Introduction		132		
Implants				
Toggle Rods		135		
Suture		135		
Instruments		136		
Instruments for CLM		136		
Retractors		137		
Drill Bits		138		
Sterilization Containers		139		
Sterilization Trays		139		
Organizer Bags		139		
Reference Materials		139		
Femoral Head Osteotomy				
Introduction		140		
Instruments		141		
Femoral Ligament Cutters	141			
Retractors	141			
Bone Holding Forceps	142			
Hip	Osteotomes	143		
	Mallets	143		
	Bone Cutting Forceps	144		
	Rasps	144		
	Rongeurs	145		
	Pelvic Osteotomy			
	Introduction	146		
	Implants	147		
	Triple Pelvic Osteotomy Plates	147		
	Double Pelvic Osteotomy Plates	148		
	Screws	149		
	Instruments	150		
	Drill Bits	150		
	Drill Guides	150		
	Depth Gauges	151		
	Screwdrivers, Handles & Shafts	151		
Retractors	153			
Bone Holding Forceps	154			
Sterilization Containers	155			
Carpus & Tarsus	Arthrodesis			
	Introduction	156		
	Implants	158		
	Pancarpal Arthrodesis Plates	158		
	Pantarsal Arthrodesis Plates	159		
	Screws	160		
	Velocity Bone Graft	163		
	Instruments	163		
	Screw & Plate Forceps	163		
	Bone Reduction Forceps	164		
	Retractors	164		
	Burs & Rasps	165		
	Drill Bits	166		
	Drill Guides	166		
	Depth Gauges	167		
	Screwdrivers, Handles & Shafts	167		
Sterilization Containers	169			

Stifle

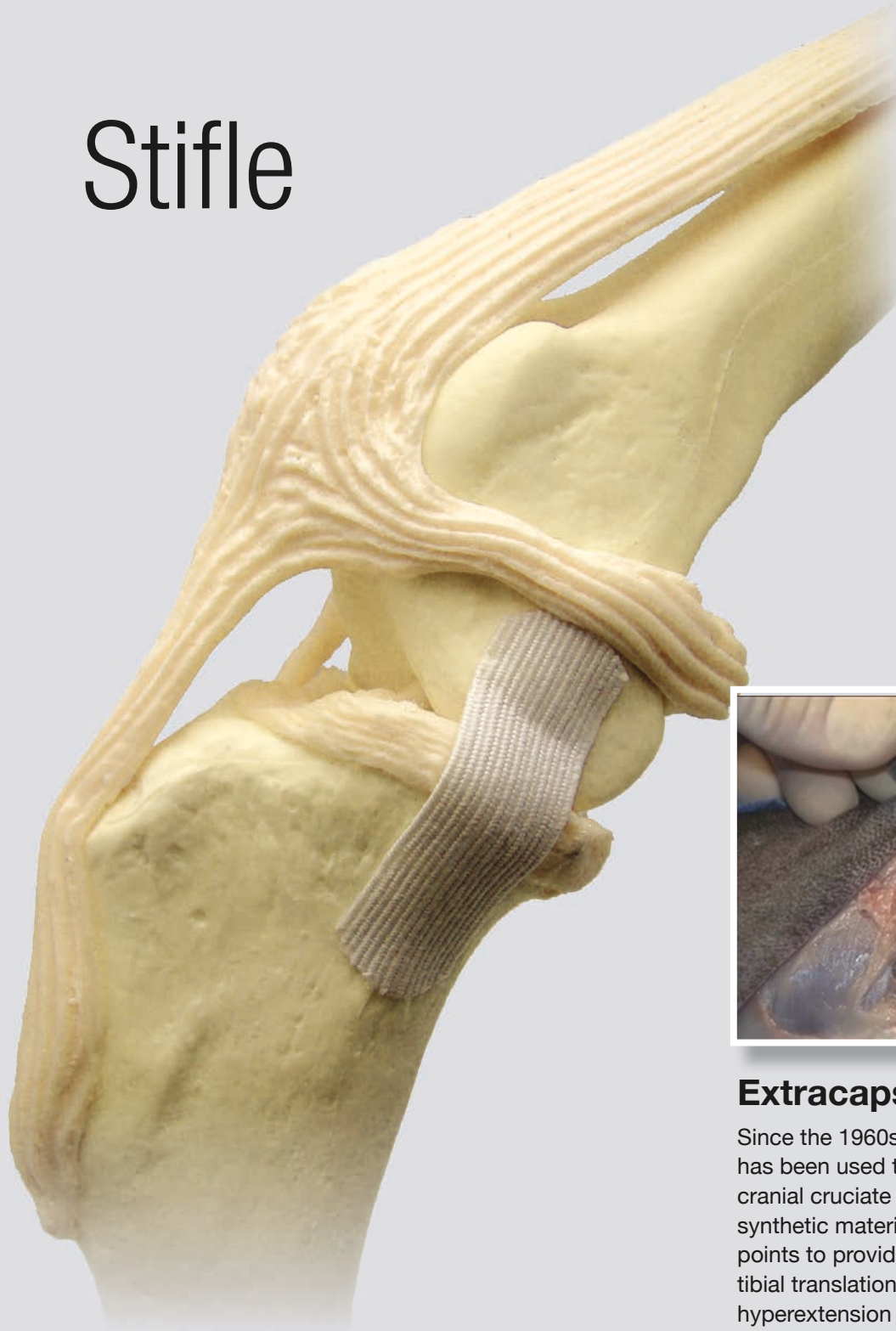

Extracapsular Stabilization

Since the 1960s, Extracapsular Stabilization (ES) has been used to correct stifle instability due to cranial cruciate ligament rupture. ES combines synthetic materials with femoral and tibial fixation points to provide passive resistance to cranial tibial translation, internal rotation of the tibia, and hyperextension of the stifle joint such that long term stability and function can be accomplished through periarticular fibrosis.

SECUROS launched its repeatable, calibrated crimping system in 1997 and has continued to pioneer the ES procedure with the advent of breakaway Bone Anchors, Titanium Nitride Coated Crimp Clamps, OrthoFiber suture, and the PowerX Crimping Device. SECUROS is the name you trust for Extracapsular Stabilization.



Tibial Tuberosity Advancement

Tibial Tuberosity Advancement (TTA) was described for use in dogs in the 2000s. The premise of TTA is that an increase in the efficiency of the quadriceps mechanism will subsequently neutralize cranial tibiofemoral shear force in the cranial cruciate ligament deficient stifle. TTA involves an osteotomy of the cranial tibial tuberosity and perpendicular alignment of the patella ligament and common tangent of the femorotibial joint to eliminate cranial tibial thrust.

SECUROS offers an assortment of innovative implants and instruments for TTA including XGEN “forkless” TTA plates, Cut-to-Length TTA cages, PLX spacers, and Velocity Bioactive Synthetic Bone Graft product lines. Newly introduced in 2014 is an expanded line of “long” plates in Standard and XGEN styles as well as a full range of “half” cage sizes in Standard and Cut-to-Length styles.



Tibial Plateau Leveling Osteotomy

Tibial Plateau Leveling Osteotomy was introduced in the 1990s to address stifle instability due to cranial cruciate ligament rupture. TPLO

limits tibiofemoral shear force by decreasing the natural orientation of the tibial plateau, thereby eliminating cranial tibial thrust. This is achieved by creating a proximal tibial osteotomy and rotating the proximal segment to decrease the tibial plateau angle.

SECUROS first introduced its patented TPLO plate in 2003 and through the years has vastly expanded its product offering to include a full range of TPLO instrumentation and power equipment to provide the ultimate TPLO experience.

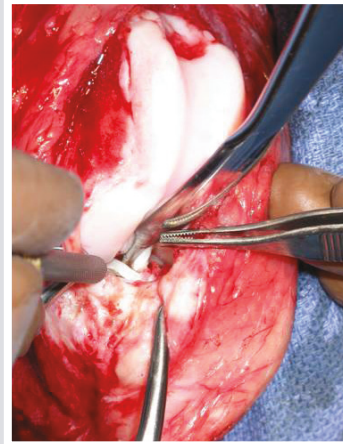

Meniscal Management

Meniscal injury is often associated with cranial cruciate ligament rupture in dogs. It is theorized that meniscal injury is caused by excessive caudal sliding of the femoral condyle due to cranial cruciate ligament instability. Accurate assessment of the menisci is important for the proper

surgical treatment of meniscal pathology in dogs.

SECUROS offers a wide array of instrumentation for proper diagnosis and treatment of meniscal injury including blade handle and blades, retractors, probes, hooks, forceps, and rongeurs.

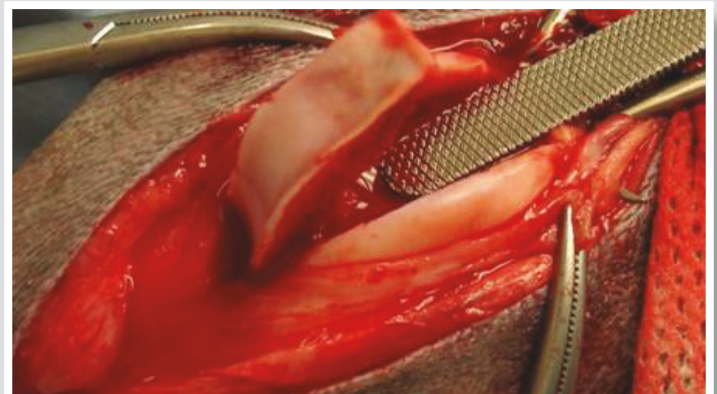

Patellar Luxation

Luxation of the patella is one of the most common orthopedic conditions in dogs. The cause of patellar luxation is considered to be a consequence of a variety of skeletal abnormalities affecting the stifle. Several strategies may be required to correct patellar luxation including reconstruction of the patellar soft tissues, deepening of the femoral groove, transposition of the tibial crest, and correction of femoral deformity.

SECUROS features a comprehensive collection of pins, wires, instruments, and saws that provide flexibility and versatility in patellar luxation corrective surgical treatment.

Superior Crimping System

The PowerX Crimping Device is the 4th generation of SECUROS crimping devices and delivers several benefits over previous models:

- 50% **increase** in **holding strength** (as measured by ultimate tensile strength)
- 5X **mechanical advantage** due to multi-action design
- **Compatible** with monofilament nylon (40#, 80#, and 100#) and OrthoFiber sutures
- **Precisely engineered** wave pattern delivers three crimps at once
- Pat. No. 8,495,902

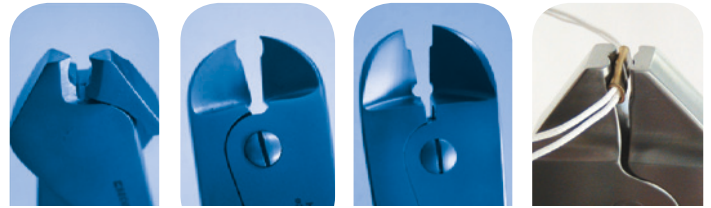

G E N E R A T I O N S

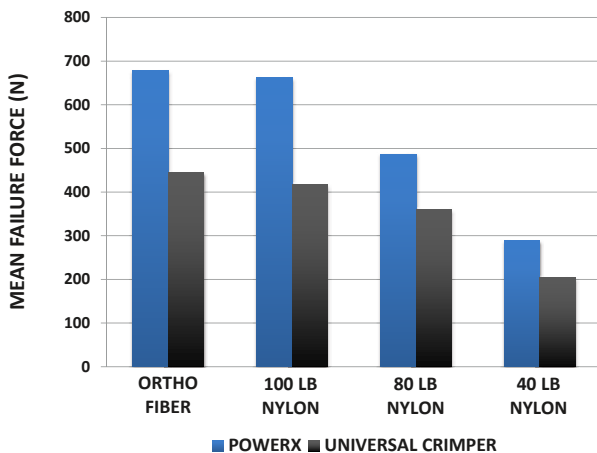



GENERATIONS

Since the introduction of the Crimping System in 1997, SECUROS has continued its commitment to innovation by optimizing the Crimping Device design through multiple generations. The PowerX Crimping Device is the 4th generation design, providing superior crimping benefits over previous models.

Step by Step Extracapsular Stabilization

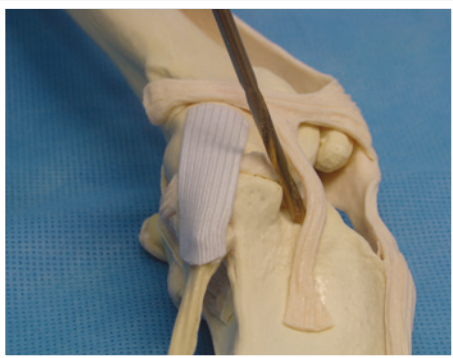

Step 1: Drill tibial tunnel centered in or near the muscular groove of the tibia. The tunnel should be placed as proximal as possible with caution taken to avoid entering the joint.

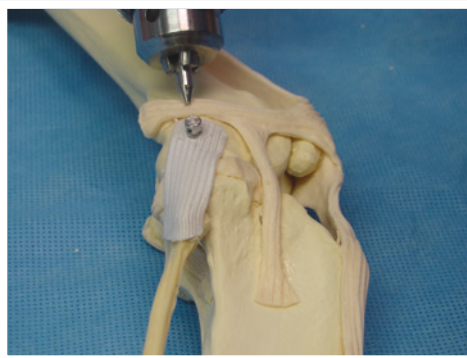

Step 2: For bone anchor technique, insert bone anchor in lateral femoral condyle and break away shaft. For fabella technique, use cruciate needle to pass suture around the fabella.

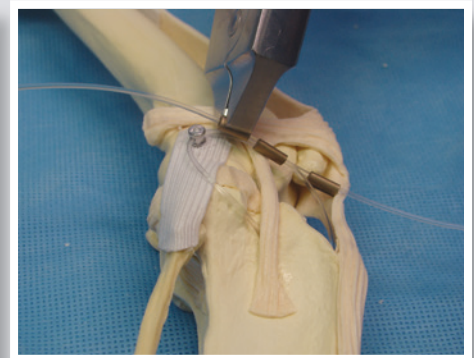

Step 3: Pass suture through bone anchor, tibial tunnel, and caudal to the patellar tendon. Loop suture through primary crimp clamp and place secondary crimp clamps on end strands. Center PowerX crimping device on secondary crimps and crimp down completely.

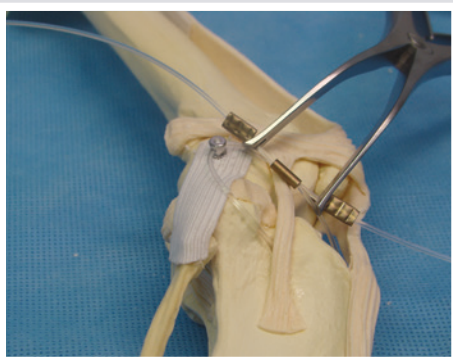

Step 4: Using tensioning device, apply tension to the suture loop. Test for tibial thrust and cranial drawer while tensioner holds the construct in place.

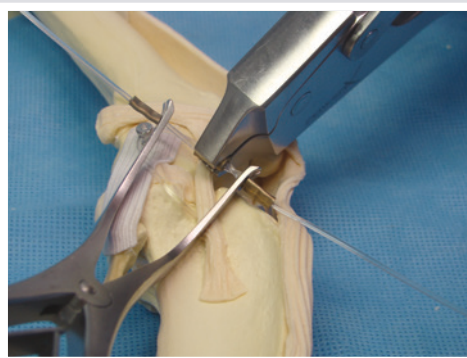

Step 5: Once the ideal amount of tension is applied and tibial thrust and cranial drawer is eliminated, center the PowerX crimping device on the primary crimp clamp and crimp down completely.

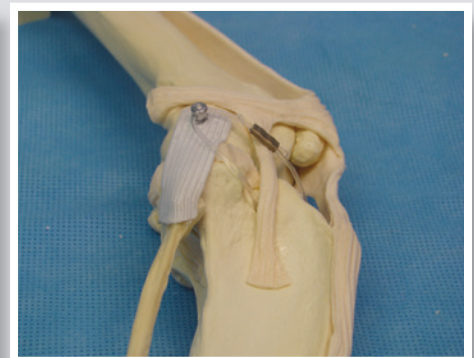

Step 6: Cut off the secondary crimp clamps, leaving the suture loop and only the primary crimp in the patient.

IMPLANTS

Swaged-on Suture (Sterile)

Single Strand Swaged-on Monofilament Nylon Suture (Box of 6, 30" Length, Sterile)



MWI#	SECUROS#	PRODUCT DESCRIPTION	DIAMETER (")	RECOMMENDED FOR SINGLE STRAND BONE TUNNEL		RECOMMENDED FOR DOUBLE STRAND BONE TUNNEL	
				DRILL BIT (mm)	IM PIN (")	DRILL BIT (mm)	IM PIN (")
029036	000372	40# Suture with Mini Cruciate Needle	0.032	1.5, 1.8	1/16	2.4, 2.5	3/32
029035	001178	40# Suture with Small Cruciate Needle	0.032	1.5, 1.8	1/16	2.4, 2.5	3/32
029034	001177	40# Suture with Medium Cruciate Needle	0.032	1.5, 1.8	1/16	2.4, 2.5	3/32
029033	001176	80# Suture with Small Cruciate Needle	0.045	2.4, 2.5	3/32	3.5	9/64
029032	001175	80# Suture with Medium Cruciate Needle	0.045	2.4, 2.5	3/32	3.5	9/64
029031	001174	80# Suture with Large Cruciate Needle	0.045	2.4, 2.5	3/32	3.5	9/64
035879	000511	100# Suture with Medium Cruciate Needle	0.055	2.7, 3.2	1/8	4.0	5/32

Single Strand Double Swaged-on Monofilament Nylon Suture (Box of 6, 30" Length, Sterile)



MWI#	SECUROS#	PRODUCT DESCRIPTION	DIAMETER (")	RECOMMENDED FOR SINGLE STRAND BONE TUNNEL		RECOMMENDED FOR DOUBLE STRAND BONE TUNNEL	
				DRILL BIT (mm)	IM PIN (")	DRILL BIT (mm)	IM PIN (")
036062	001190	40# Suture with Small Cruciate & 3" Straight Needles	0.032	1.5, 1.8	1/16	2.4, 2.5	3/32
035973	001186	40# Suture with Medium Cruciate & 3" Straight Needles	0.032	1.5, 1.8	1/16	2.4, 2.5	3/32
045572	001192	80# Suture with Small Cruciate & 3" Straight Needles	0.045	2.4, 2.5	3/32	3.5	9/64
042088	001188	80# Suture with Medium Cruciate & 3" Straight Needles	0.045	2.4, 2.5	3/32	3.5	9/64
036207	001194	80# Suture with Large Cruciate & 3" Straight Needles	0.045	2.4, 2.5	3/32	3.5	9/64

Swaged on Suture (Sterile)

Double Strand Swaged-on Monofilament Nylon Suture (Box of 6, 30" Length, Sterile)



MWI#	SECUROS#	PRODUCT DESCRIPTION	DIAMETER (")	RECOMMENDED FOR SINGLE STRAND BONE TUNNEL		RECOMMENDED FOR DOUBLE STRAND BONE TUNNEL	
				DRILL BIT (mm)	IM PIN (")	DRILL BIT (mm)	IM PIN (")
029041	001184	40# Suture with Small Cruciate Needle	0.032	1.5, 1.8	1/16	2.4, 2.5	3/32
029040	001183	40# Suture with Medium Cruciate Needle	0.032	1.5, 1.8	1/16	2.4, 2.5	3/32
029039	001182	80# Suture with Small Cruciate Needle	0.045	2.4, 2.5	3/32	3.5	9/64
029038	001181	80# Suture with Medium Cruciate Needle	0.045	2.4, 2.5	3/32	3.5	9/64
029037	001180	80# Suture with Large Cruciate Needle	0.045	2.4, 2.5	3/32	3.5	9/64

Double Strand Double Swaged-on Monofilament Nylon Suture (Box of 6, 30" Length, Sterile)



MWI#	SECUROS#	PRODUCT DESCRIPTION	DIAMETER (")	RECOMMENDED FOR SINGLE STRAND BONE TUNNEL		RECOMMENDED FOR DOUBLE STRAND BONE TUNNEL	
				DRILL BIT (mm)	IM PIN (")	DRILL BIT (mm)	IM PIN (")
042089	001189	40# Suture with Small Cruciate & 3" Straight Needles	0.032	1.5, 1.8	1/16	2.4, 2.5	3/32
036195	001185	40# Suture with Medium Cruciate & 3" Straight Needles	0.032	1.5, 1.8	1/16	2.4, 2.5	3/32
056016	001191	80# Suture with Small Cruciate & 3" Straight Needles	0.045	2.4, 2.5	3/32	3.5	9/64
036056	001187	80# Suture with Medium Cruciate & 3" Straight Needles	0.045	2.4, 2.5	3/32	3.5	9/64
036183	001193	80# Suture with Large Cruciate & 3" Straight Needles	0.045	2.4, 2.5	3/32	3.5	9/64

Swaged-on Suture (Sterile)

Single Strand OrthoFiber Braided Polyethylene (Non-absorbable) Suture (Box of 12, 36" Length, Sterile)



001104

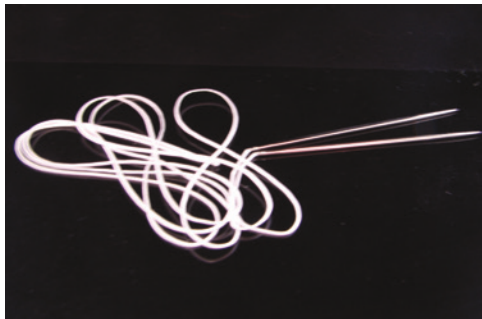

004767



000371

MWI#	SECUROS#	PRODUCT DESCRIPTION	DIAMETER (")	RECOMMENDED FOR SINGLE STRAND BONE TUNNEL		RECOMMENDED FOR DOUBLE STRAND BONE TUNNEL	
				DRILL BIT (mm)	IM PIN (")	DRILL BIT (mm)	IM PIN (")
055171	005506	#2 OrthoFiber Suture without Needles	0.020	1.5, 1.8	1/16	2.4, 2.5	3/32
045540	004767	#2 OrthoFiber Suture with 2-3" Straight Needles	0.020	1.5, 1.8	1/16	2.4, 2.5	3/32
031032	001104	#5 OrthoFiber Suture without Needles	0.027	1.5, 1.8	1/16	2.4, 2.5	3/32
035917	000370	#5 OrthoFiber Suture with Small Cruciate & 3" Straight Needles	0.027	1.5, 1.8	1/16	2.4, 2.5	3/32
035248	000371	#5 OrthoFiber Suture with Medium Cruciate & 3" Straight Needles	0.027	1.5, 1.8	1/16	2.4, 2.5	3/32

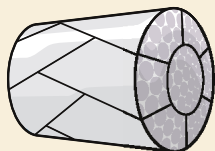

OrthoFiber is a braided sterile surgical suture prepared from ultra-high molecular weight, long-chain linear polyethylene (UHMWPE) fibers. Its unique, inter-locking core technology provides a sturdy core within the center of the suture to act as a backbone for enhanced handling characteristics. Additional benefits of OrthoFiber include:

- Improved strength and superior fixation characteristics over monofilament
- Superior abrasion resistance when compared to polyester
- Excellent biocompatibility as measured and tested according to ISO 10993
- Available in a variety of pre-sterile suture pack configurations

Suture Spools

Monofilament Nylon Suture Spools (100 Yard Length)



MWI#	SECUROS#	PRODUCT DESCRIPTION	DIAMETER (")	RECOMMENDED FOR SINGLE STRAND BONE TUNNEL		RECOMMENDED FOR DOUBLE STRAND BONE TUNNEL	
				DRILL BIT (mm)	IM PIN (")	DRILL BIT (mm)	IM PIN (")
029042	001198	20#	0.022	1.1	1/16	2.0	5/64
029043	001199	40#	0.032	1.5, 1.8	1/16	2.4, 2.5	3/32
029045	002073	60#	0.036	2.0	5/64	2.7, 3.2	1/8
029046	001004	80#	0.045	2.4, 2.5	3/32	3.5	9/64
029047	001106	100#	0.055	2.7, 3.2	1/8	4.0	5/32

Suture Needles

Cruciate Needles (Taper Point, Pack of 6)



MWI#	SECUROS#	PRODUCT DESCRIPTION
029029	001172	Mini (Size 5)
029028	001171	Small (Size 4)
029027	001170	Medium (Size 3)
029026	001169	Large (Size 2)
029030	001173	Cruciate Needle Variety Pack (2-Small, 2-Medium, 2-Large)

Straight Needles (Taper Point, Pack of 6)



MWI#	SECUROS#	PRODUCT DESCRIPTION
036208	001195	3"
056021	001196	4"
056022	001197	Straight Needle Variety Pack (3-3", 3-4")

Crimp Clamps

Stainless Steel Crimp Clamps (Pack of 15)



001148 001145 001107 001105

Titanium Nitride (TiN) Coated Stainless Steel Crimp Clamps (Pack of 15)

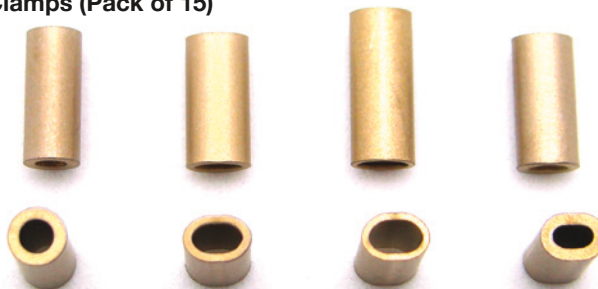

004351 004352 004354 004559

MWI#	SECUROS#	PRODUCT DESCRIPTION
029023	001148	40# Crimp Clamps
029024	001145	80# Crimp Clamps
029025	001107	100# Crimp Clamps
031031	001105	OrthoFiber Crimp Clamps

MWI#	SECUROS#	PRODUCT DESCRIPTION
037936	004351	40# TiN Coated Crimp Clamps
037937	004352	80# TiN Coated Crimp Clamps
037938	004354	100# TiN Coated Crimp Clamps
038483	004559	OrthoFiber TiN Coated Crimp Clamps

Medical Coated Crimp Clamps Improve Biocompatibility

SECUROS is the only veterinary orthopedic company to offer Titanium Nitride (TiN) coated crimp clamps. TiN is a high quality thin-film medical grade coating applied to the surface of the crimp clamp. Benefits of TiN include:



- Increased biocompatibility provided by a chemically inert TiN barrier on surface of implant
- Improved corrosion resistance of the 316LVM stainless steel implant and autoclave induced corrosion
- Improved wear resistance prevents material erosion in high wear areas

Monofilament Nylon Suture & Crimp Clamp Packs (Sterile)

Suture & Stainless Steel Crimp Clamps (1-30" Suture, 3 Crimp Clamps)

Suture & TiN Coated Stainless Steel Crimp Clamps (1-30" Suture, 3 Crimp Clamps)

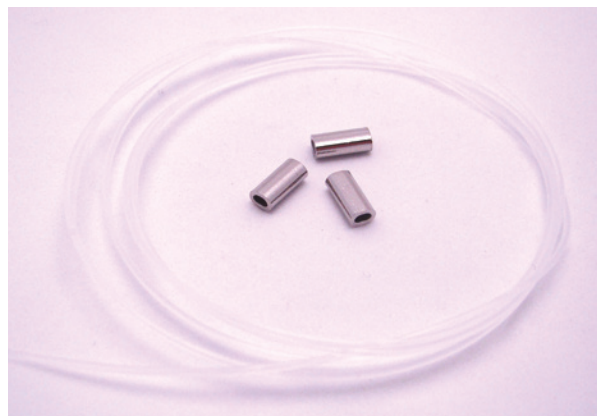

Contents of Sterile Pouch

MWI#	SECUROS#	PRODUCT DESCRIPTION
031123	003523	40# Suture & Crimp Clamps
031124	004005	80# Suture & Crimp Clamps
032392	001108	100# Suture & Crimp Clamps

MWI#	SECUROS#	PRODUCT DESCRIPTION
055114	004906	40# Suture & TiN Coated Crimp Clamps
055115	004907	80# Suture & TiN Coated Crimp Clamps
055116	004908	100# Suture & TiN Coated Crimp Clamps

Bone Anchors

Break-off Bone Anchors (Stainless Steel)



MWI#	SECUROS#	PRODUCT DESCRIPTION	THREAD LENGTH (mm)	RECOMMENDED FOR BONE ANCHOR	
				SUTURE	DRILL BIT (mm)
030974	001165	2.7mm Bone Anchor	13	1-40#, 1-OrthoFiber	2.4
030975	001166	3.5mm Bone Anchor	16	1-80#, 1-OrthoFiber	3.2
031017	001167	4.5mm Bone Anchor	19	2-80#, 1-100#, 2-OrthoFiber	3.2

Break-off Bone Anchors (Titanium)



MWI#	SECUROS#	PRODUCT DESCRIPTION	THREAD LENGTH (mm)	COLOR	RECOMMENDED FOR BONE ANCHOR	
					SUTURE	DRILL BIT (mm)
035881	003524	2.7mm Bone Anchor	13	Blue	1-40#, 1-OrthoFiber	2.4
035876	003525	3.5mm Bone Anchor	16	Gold	1-80#, 1-OrthoFiber	3.2
035874	003526	4.5mm Bone Anchor	19	Green	2-80#, 1-100#, 2-OrthoFiber	3.2

Step by Step Bone Anchors

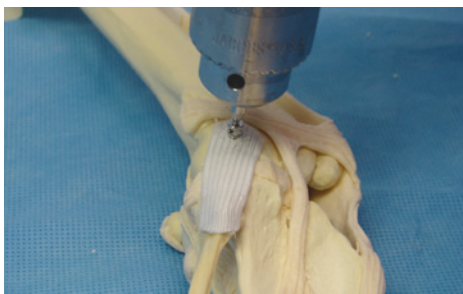

Step 1: Insert bone anchor using hand chuck or power drill.

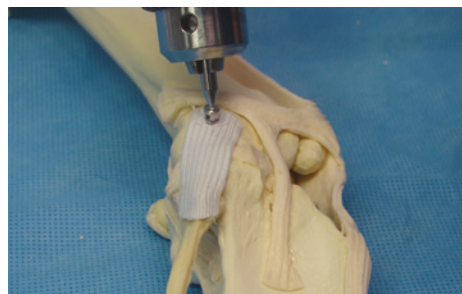

Step 2: Bend shaft of bone anchor.

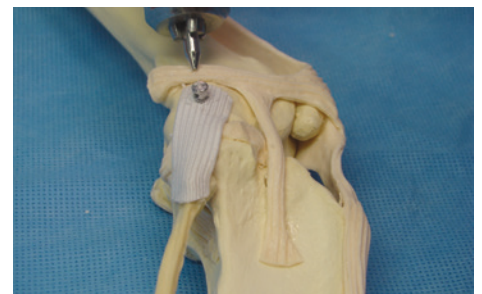

Step 3: Break away shaft, leaving threaded portion and eyelet in bone.

Bone Anchors

Box Head Bone Anchors (Stainless Steel)



004307

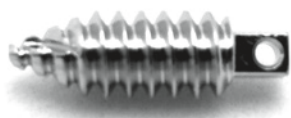

004306



004305

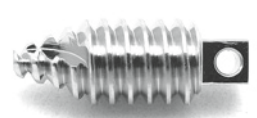

004288

MWI#	SECUROS#	PRODUCT DESCRIPTION	THREAD LENGTH (mm)	RECOMMENDED FOR BONE ANCHOR	
				SUTURE	DRILL BIT (mm)
044067	004307	4.0mm Box Head Bone Anchor - Short Thread	6	1-40#, 1-OrthoFiber	2.7
044617	004306	4.0mm Box Head Bone Anchor - Long Thread	10	1-40#, 1-OrthoFiber	2.7
045499	004305	4.7mm Box Head Bone Anchor - Short Thread	6	1-80#, 1-OrthoFiber	3.5
042427	004288	4.7mm Box Head Bone Anchor - Long Thread	10	1-80#, 1-OrthoFiber	3.5
390164	005500	4.0mm Box Head Bone Anchor Driver	-	-	-
390165	005501	4.7mm Box Head Bone Anchor Driver	-	-	-



INSTRUMENTS

Instruments for Extracapsular Stabilization



MWI#	SECUROS#	PRODUCT DESCRIPTION	LENGTH (")
037934	004033	PowerX Crimping Device	8.75

Superior Crimping System

The PowerX Crimping Device is the 4th generation of SECUROS crimping devices and provides several benefits over previous models:

- 50% increase in holding strength (as measured by ultimate tensile strength)¹
- 5X mechanical advantage due to multi-action design
- Compatible with monofilament nylon (40#, 80#, and 100#) and OrthoFiber sutures
- Precisely engineered wave pattern provides three crimps at once

¹. Maritato KC, Barnhard MD, Kazanovicz AJ, et al. In vitro mechanical evaluation and comparison of two crimping devices for securing monofilament nylon and multifilament polyethylene for use in extracapsular stabilization of the canine stifle. Vet Comp Orthop Traumatol 2012; 25.



MWI#	SECUROS#	PRODUCT DESCRIPTION	LENGTH (")
031037	001144	Universal Tensioning Device	6.5
056019	001162	Replacement Springs for Tensioning Device	-



MWI#	SECUROS#	PRODUCT DESCRIPTION	FEATURE	LENGTH (")
043935	840168	Cruciate Needle Holder	Tungsten Carbide Jaws	7

Drill Bits

Jacobs Chuck Coupling (BITE Bit, Titanium Nitride Coated)



MWI#	SECUROS#	DIAMETER (mm)	TOTAL LENGTH (mm)	FLUTE LENGTH (mm)	RECOMMENDED FOR USE WITH BONE ANCHOR
031129	001358	2.4	142	33	2.7mm Break-Off
028997	002038	2.7	88	50	4.0mm Box Head
028992	001357	3.2	165	33	3.5/4.5mm Break-Off
029005	002040	3.5	96	50	4.7mm Box Head

Hand Chucks



MWI#	SECUROS#	PRODUCT DESCRIPTION	MAXIMUM PIN SIZE (")	LENGTH (")
029519	001480	Mini Dual Hand Chuck	5/32"	5.75
029517	001479	Dual Chuck Hand Chuck	1/4"	6.5



MWI#	SECUROS#	PRODUCT DESCRIPTION	LENGTH (")
047958	005015	Jacobs Chuck Key Extension Handle	5.5

Steinmann/Intramedullary Pins (Smooth, Trocar/Trocar)



MWI#	SECUROS#	DIAMETER (")	LENGTH (")
029059	001237	3/32	9
029061	001239	1/8	9

POWER EQUIPMENT Battery Powered Drill



001483



001485

MWI#	SECUROS#	PRODUCT DESCRIPTION
040048	001483	Orthopedic Drill Kit
035453	001485	Orthopedic Drill Kit with Dual Chuck Hand Chuck and Shroud
045117	001486	Orthopedic Drill Kit with Mini Dual Hand Chuck and Shroud

STERILIZATION CONTAINERS Sterilization Trays

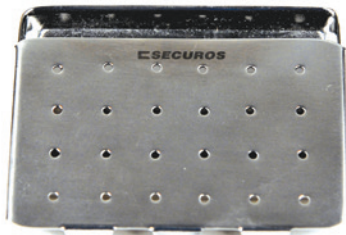

001003



000513



004870

MWI#	SECUROS#	PRODUCT DESCRIPTION	LENGTH (")	WIDTH (")	HEIGHT (")
029096	001003	Perforated Tray	2.75	2	0.5
ACCOMMODATES					
Cruciate Needles, Crimp Clamps					

MWI#	SECUROS#	PRODUCT DESCRIPTION	LENGTH (")	WIDTH (")	HEIGHT (")
042046	000513	Perforated Tray	10	6.5	2
ACCOMMODATES					
Instruments					

MWI#	SECUROS#	PRODUCT DESCRIPTION	LENGTH (")	WIDTH (")	HEIGHT (")
049104	004870	PowerX Tray	11	0.75	2.25
ACCOMMODATES					
Bone Anchors, PowerX Crimping Device, Universal Tensioning Device, Cruciate Needle Holder, Micro Beaver Blade Handle, 6-8mm Hohmann Retractor, Small Sterilization Tray (4)					

Organizer Bags



MWI#	SECUROS#	PRODUCT DESCRIPTION
031192	001007	Extracapsular Stabilization Organizer Bag
ACCOMMODATES		
Universal Crimping Device, Universal Tensioning Device, Cruciate Needle Holder, Micro Beaver Blade Handle, Senn Retractor, 6-8mm Hohmann Retractor, Small Sterilization Tray (3)		



MWI#	SECUROS#	PRODUCT DESCRIPTION
035926	001008	Bone Anchor Organizer Bag
ACCOMMODATES		
Bone Anchors, 2.4mm and 3.2mm Drill Bits, Dual Chuck Hand Chuck, Chuck Key, Small Sterilization Tray (2)		

REFERENCE MATERIALS



MWI#	SECUROS#	PRODUCT DESCRIPTION
■ 372164	005491	Extracapsular Stabilization Bone Model
035251	001164	Extracapsular Stabilization Instructional CD Rom





Next Generation TTA

- **No fork** means greater versatility in contouring the plate - contouring does not affect screw placement!
- **No hammering!** Since no force is needed to seat the XGEN plate, there's no concern of separating the tuberosity prior to completing the cut
- More **flexibility** in adjusting plate orientation (XGEN plate can pivot around top screw)
- **Less holes** in bone equal fewer stress risers
- The **XGEN** plate hole spacing offers **greater proximal/distal placement options** on the tuberosity
- No forks equal **less inventory**
- **Greater plate** versatility intra-operatively



TTA Case Study

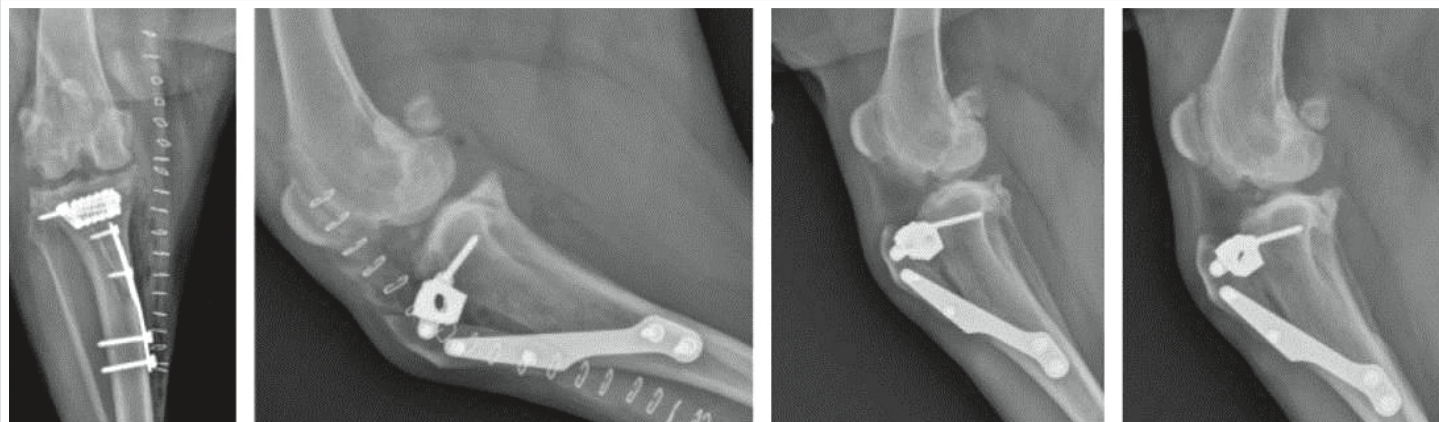

Radiographs provided by Matthew Barnhart, DVM, MS, DACVS, MedVet—Ohio

Velocity

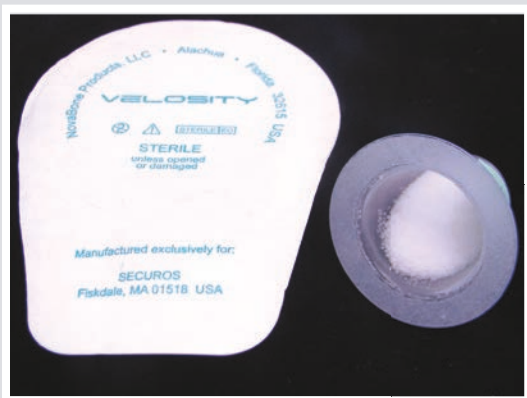

Velocity Bioactive Synthetic Bone Graft is comprised of 100% synthetic bioactive materials that are composed from elements that naturally occur in the body. The carrier is rapidly removed from the site through enzymatic activity leaving behind a bioactive material capable of regenerating new bone from existing bone. Both the Velocity Putty and Particulate are osteostimulative; defined as the active stimulation of osteoblast proliferation and differentiation due to ionic dissolution products released from Velocity during absorption.

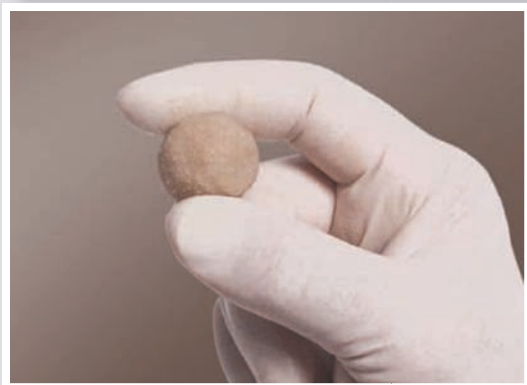

IMPLANTS

Standard TTA Cages

Standard TTA Cages - Stainless Steel (For use with 2.4mm screws)

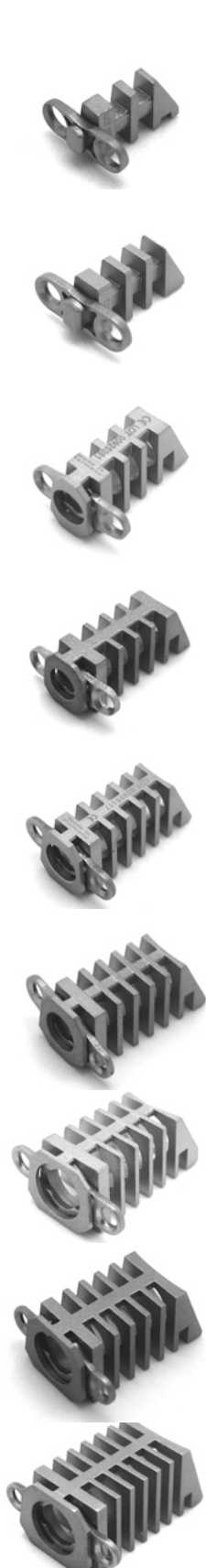

MWI#	SECUROS#	WIDTH (mm)	LENGTH (mm)
052085	005042	3	10
042058	000717	3	13
042059	000718	3	16
042060	000719	3	19
MWI#	SECUROS#	WIDTH (mm)	LENGTH (mm)
052086	005048	4.5	10
052087	005049	4.5	13
052088	005050	4.5	16
MWI#	SECUROS#	WIDTH (mm)	LENGTH (mm)
052089	005054	6	13
029510	001615	6	16
029511	001616	6	19
029512	001617	6	22
MWI#	SECUROS#	WIDTH (mm)	LENGTH (mm)
052090	004440	7.5	16
052091	004441	7.5	19
052092	004442	7.5	22
MWI#	SECUROS#	WIDTH (mm)	LENGTH (mm)
052093	005056	9	16
029513	001618	9	19
029514	001619	9	22
029515	001620	9	25
MWI#	SECUROS#	WIDTH (mm)	LENGTH (mm)
052094	004449	10.5	19
052095	004454	10.5	22
052096	004456	10.5	25
MWI#	SECUROS#	WIDTH (mm)	LENGTH (mm)
029507	001621	12	22
029508	001622	12	25
029509	003553	12	28
MWI#	SECUROS#	WIDTH (mm)	LENGTH (mm)
052097	005060	13.5	22
052098	005061	13.5	25
052099	005062	13.5	28
MWI#	SECUROS#	WIDTH (mm)	LENGTH (mm)
052143	005068	15	25
052141	005069	15	28
052142	005070	15	31

Standard TTA Cages

Standard TTA Cages - Titanium (For use with 2.4mm screws)



MWI#	SECUROS#	WIDTH (mm)	LENGTH (mm)	COLOR
055143	005041	3	10	Gold
042061	000720	3	13	Gold
036191	000721	3	16	Gold
036187	000722	3	19	Gold

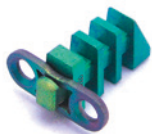

MWI#	SECUROS#	WIDTH (mm)	LENGTH (mm)	COLOR
055144	005045	4.5	10	Green
055145	005046	4.5	13	Green
055146	005047	4.5	16	Green



MWI#	SECUROS#	WIDTH (mm)	LENGTH (mm)	COLOR
055147	005053	6	13	Blue
029486	001624	6	16	Blue
029487	001625	6	19	Blue
029488	001626	6	22	Blue



MWI#	SECUROS#	WIDTH (mm)	LENGTH (mm)	COLOR
055148	004445	7.5	16	Copper
055149	004446	7.5	19	Copper
055150	004447	7.5	22	Copper



MWI#	SECUROS#	WIDTH (mm)	LENGTH (mm)	COLOR
055151	005055	9	16	Light Blue
029489	001627	9	19	Light Blue
029491	001628	9	22	Light Blue
029492	001629	9	25	Light Blue



MWI#	SECUROS#	WIDTH (mm)	LENGTH (mm)	COLOR
055152	004457	10.5	19	Purple
055153	004462	10.5	22	Purple
055154	004463	10.5	25	Purple

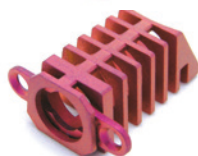

MWI#	SECUROS#	WIDTH (mm)	LENGTH (mm)	COLOR
029483	001101	12	22	Pink
029484	001102	12	25	Pink
029485	001103	12	28	Pink



MWI#	SECUROS#	WIDTH (mm)	LENGTH (mm)	COLOR
055155	005057	13.5	22	Yellow
055156	005058	13.5	25	Yellow
055157	005059	13.5	28	Yellow



MWI#	SECUROS#	WIDTH (mm)	LENGTH (mm)	COLOR
055158	005065	15	25	Brown
055159	005066	15	28	Brown
055160	005067	15	31	Brown

Cut-to-Length TTA Cages

Cut-to-Length TTA Cages - Stainless Steel (For use with 2.4mm screws)



MWI#	SECUROS#	WIDTH (mm)	LENGTH (mm)
055161	005044	3	19
055162	005052	4.5	16
042339	003736	6	22
042447	004443	7.5	22
042340	003737	9	25
043145	004455	10.5	25
038422	003738	12	28
055163	005064	13.5	28
055164	004865	15	31
042405	003788	16	34

Cut-to-Length TTA Cages

Cut-to-Length TTA Cages - Titanium (For use with 2.4mm screws)



MWI#	SECUROS #	WIDTH (mm)	LENGTH (mm)	COLOR
055165	005043	3	19	Gold
055166	005051	4.5	16	Green
042341	003739	6	22	Blue
042448	004448	7.5	22	Copper
042345	003740	9	25	Light Blue
042450	004464	10.5	25	Purple
042347	003741	12	28	Pink
055167	005063	13.5	28	Yellow
055168	004866	15	31	Brown
042404	003787	16	34	Green

TTA Cage Cutter (For use with Cut-to-Length Cages)

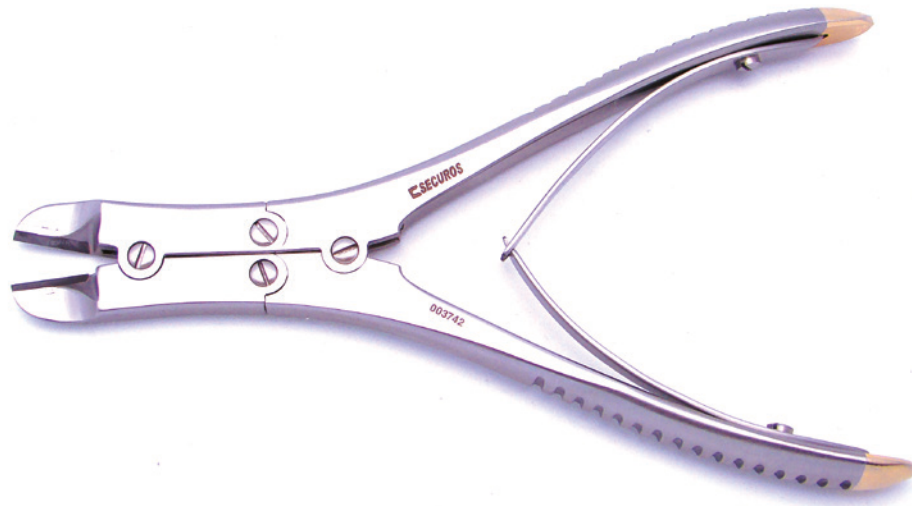

MWI#	SECUROS#	PRODUCT DESCRIPTION	FEATURE	LENGTH (")
042400	003742	TTA Cage Cutter	Tungsten Carbide Inserts	6.25

Step by Step Cutting a Cage

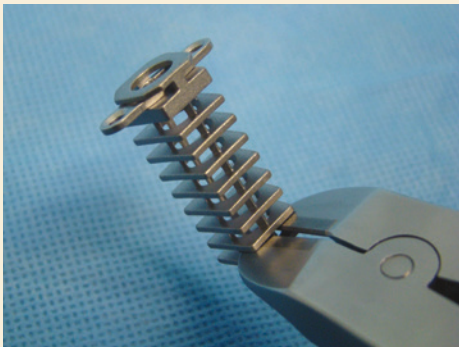

Step 1: Measure length of cage needed and determine where to begin cutting.

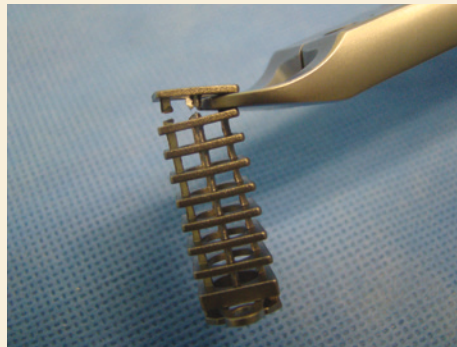

Step 2: Cut all 4 ribs at desired length.

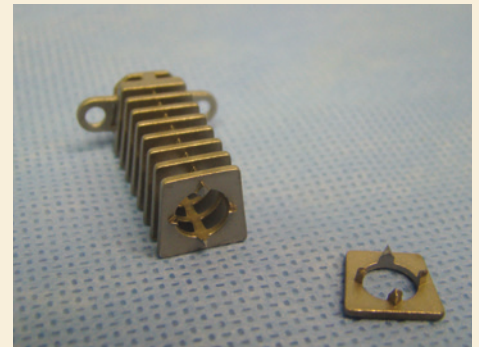

Step 3: Remove and discard the cut portion of the cage.

XGEN TTA Plates

XGEN TTA Plates - Stainless Steel (1.0mm Thickness)



590002



590006

MWI#	SECUROS#	PRODUCT DESCRIPTION	RECOMMENDED SCREWS (mm)	
			PROXIMAL HOLES	DISTAL HOLES
052711	590027	2-2 Hole	2.4	2.4
035873	590000	3-2 Hole	2.4	2.7
035877	590002	4-2 Hole	2.4	2.7
035244	590004	5-2 Hole	2.4	2.7
035249	590006	6-3 Hole	2.4	3.5
035871	590008	7-3 Hole	2.4	3.5
035915	590010	8-3 Hole	2.4	3.5

XGEN Long TTA Plates - Stainless Steel (1.0mm Thickness)



590031



590035

MWI#	SECUROS#	PRODUCT DESCRIPTION	RECOMMENDED SCREWS (mm)	
			PROXIMAL HOLES	DISTAL HOLES
052712	590029	3-2 Hole - Long	2.4	2.7
052713	590031	4-2 Hole - Long	2.4	2.7
052714	590033	5-2 Hole - Long	2.4	2.7
052715	590035	6-3 Hole - Long	2.4	3.5
052716	590037	7-3 Hole - Long	2.4	3.5
052717	590039	8-3 Hole - Long	2.4	3.5

XGEN TTA Plates

XGEN TTA Plates - Titanium (1.0mm Thickness, Purple)



591003



591007

MWI#	SECUROS#	PRODUCT DESCRIPTION	RECOMMENDED SCREWS (mm)	
			PROXIMAL HOLES	DISTAL HOLES
052718	590028	2-2 Hole	2.4	2.4
042157	591001	3-2 Hole	2.4	2.7
042158	591003	4-2 Hole	2.4	2.7
035869	591005	5-2 Hole	2.4	2.7
042159	591007	6-3 Hole	2.4	3.5
042160	591009	7-3 Hole	2.4	3.5
042161	591011	8-3 Hole	2.4	3.5

XGEN Long TTA Plates - Titanium (1.0mm Thickness, Purple)



590032



590036

MWI#	SECUROS#	PRODUCT DESCRIPTION	RECOMMENDED SCREWS (mm)	
			PROXIMAL HOLES	DISTAL HOLES
052719	590030	3-2 Hole - Long	2.4	2.7
052720	590032	4-2 Hole - Long	2.4	2.7
052721	590034	5-2 Hole - Long	2.4	2.7
052722	590036	6-3 Hole - Long	2.4	3.5
052723	590038	7-3 Hole - Long	2.4	3.5
052724	590040	8-3 Hole - Long	2.4	3.5

XGEN TTA Plates

XGEN TTA Plates - Titanium (1.5mm Thickness, Teal)



590003

590007

MWI#	SECUROS#	PRODUCT DESCRIPTION	RECOMMENDED SCREWS (mm)	
			PROXIMAL HOLES	DISTAL HOLES
035919	590001	3-2 Hole	2.4	2.7
035914	590003	4-2 Hole	2.4	2.7
042150	590005	5-2 Hole	2.4	2.7
035870	590007	6-3 Hole	2.4	3.5
035916	590009	7-3 Hole	2.4	3.5
035923	590011	8-3 Hole	2.4	3.5



Standard TTA Plates

Standard TTA Plates - Stainless Steel (1.0mm Thickness)



MWI#	SECUROS#	PRODUCT DESCRIPTION	RECOMMENDED FORK FOR PROXIMAL HOLES	RECOMMENDED SCREWS (mm) FOR DISTAL HOLES
052725	005073	2 Hole	2 Prong	2.4
029493	001091	3 Hole	3 Prong	2.7
029495	001092	4 Hole	4 Prong	2.7
029496	001093	5 Hole	5 Prong	2.7
029497	001094	6 Hole	6 Prong	3.5
029498	001095	7 Hole	7 Prong	3.5
029499	001096	8 Hole	8 Prong	3.5

Standard Long TTA Plates - Stainless Steel (1.0mm Thickness)



MWI#	SECUROS#	PRODUCT DESCRIPTION	RECOMMENDED FORK FOR PROXIMAL HOLES	RECOMMENDED SCREWS (mm) FOR DISTAL HOLES
052726	005075	3 Hole - Long	3 Prong	2.7
052727	005077	4 Hole - Long	4 Prong	2.7
052728	005079	5 Hole - Long	5 Prong	2.7
052729	005081	6 Hole - Long	6 Prong	3.5
052730	005083	7 Hole - Long	7 Prong	3.5
052731	005085	8 Hole - Long	8 Prong	3.5

Standard TTA Plates

Standard TTA Plates - Titanium (1.0mm Thickness, Teal)



MWI#	SECUROS#	PRODUCT DESCRIPTION	RECOMMENDED FORK FOR PROXIMAL HOLES	RECOMMENDED SCREWS (mm) FOR DISTAL HOLES
052732	005072	2 Hole	2 Prong	2.4
029471	001097	3 Hole	3 Prong	2.7
029472	001098	4 Hole	4 Prong	2.7
029473	001099	5 Hole	5 Prong	2.7
029474	001100	6 Hole	6 Prong	3.5
029475	001601	7 Hole	7 Prong	3.5
029476	001602	8 Hole	8 Prong	3.5

Standard Long TTA Plates - Titanium (1.0mm Thickness, Teal)



MWI#	SECUROS#	PRODUCT DESCRIPTION	RECOMMENDED FORK FOR PROXIMAL HOLES	RECOMMENDED SCREWS (mm) FOR DISTAL HOLES
052733	005074	3 Hole - Long	3 Prong	2.7
052734	005076	4 Hole - Long	4 Prong	2.7
052735	005078	5 Hole - Long	5 Prong	2.7
052736	005080	6 Hole - Long	6 Prong	3.5
052737	005082	7 Hole - Long	7 Prong	3.5
052738	005084	8 Hole - Long	8 Prong	3.5

TTA Forks

TTA Forks - Stainless Steel (For use with Stainless Steel Standard or Standard Long TTA Plates)

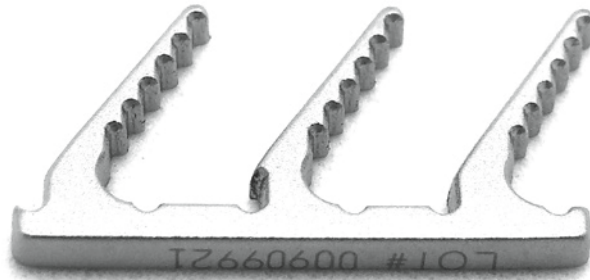

MWI#	SECUROS#	PRODUCT DESCRIPTION
052739	005087	2 Prong
029502	001603	3 Prong
029501	001604	4 Prong
029503	001605	5 Prong
029504	001606	6 Prong
029505	001607	7 Prong
029506	001608	8 Prong

TTA Forks - Titanium (Gold, For use with Titanium Standard or Standard Long TTA Plates)

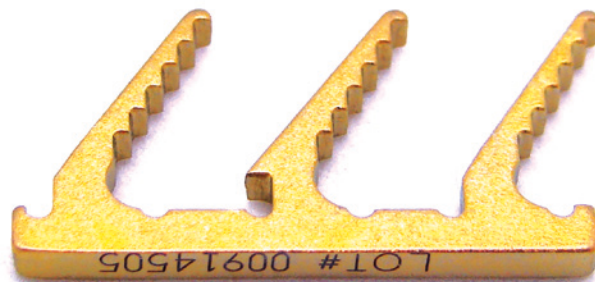

MWI#	SECUROS#	PRODUCT DESCRIPTION
052740	005086	2 Prong
042211	001609	3 Prong
029478	001610	4 Prong
029479	001611	5 Prong
029480	001612	6 Prong
029481	001613	7 Prong
029482	001614	8 Prong

2.4mm Cortical Screws

2.4mm Cortical Screw, Self-Tapping, Cruciform Recess-Stainless Steel



Diameter of Thread: 2.4mm

Diameter of Head: 4.0mm

Drill Bit for Threaded Hole: 1.8mm

For Use with 2.4mm Cruciform Screwdriver

MWI#	SECUROS#	LENGTH (mm)
047227	100095	6
047228	100096	7
047229	100097	8
047230	100098	9
047231	100099	10
047232	100100	11
047233	100101	12
047234	100102	13
047235	100103	14
047236	100104	16
047237	100105	18
047238	100106	20
047239	100107	22
047240	100108	24
047241	100109	26
047242	100110	28
047243	100111	30
047244	100112	32
047245	100113	34
047246	100114	36
047247	100115	38
047248	100116	40

2.4mm Cortical Screw, Self-Tapping, Cruciform Recess-Titanium (Copper)



Diameter of Thread: 2.4mm

Diameter of Head: 4.0mm

Drill Bit for Threaded Hole: 1.8mm

For Use with 2.4mm Cruciform Screwdriver

MWI#	SECUROS#	LENGTH (mm)
■ 370030	100089	6
■ 370031	100090	7
■ 370032	100091	8
■ 370033	100092	9
049255	005021	10
■ 370034	100093	11
049256	005023	12
■ 370035	100094	13
049257	005024	14
049258	005025	16
049259	005026	18
049260	005027	20
049261	005028	22
049262	005029	24
049263	005030	26
049264	005031	28
049265	005032	30
049266	005033	32
049268	005034	34
049269	005035	36
049270	005036	38
049271	005037	40

■ special order item

2.4mm Cortical Screws

2.4mm Cortical Screw, Self-Tapping, Hexagonal Recess- Stainless Steel



Diameter of Thread: 2.4mm

Diameter of Head: 4.0mm

Drill Bit for Threaded Hole: 1.8mm

For Use with 2.4mm Hexagonal Screwdriver

MW/#	SECUROS#	LENGTH (mm)
042298	002613	6
■ 370020	005133	7
042299	002614	8
■ 370021	005134	9
030982	001027	10
■ 370022	005135	11
030983	001028	12
■ 370023	005136	13
030984	001029	14
030985	001030	16
030986	001031	18
030987	001032	20
030980	001033	22
030988	001034	24
030989	001035	26
030981	001036	28
030990	001037	30
030991	001038	32
030992	001039	34
030993	001040	36
030994	001041	38
030995	001042	40

2.4mm Cortical Screw, Self-Tapping, Hexagonal Recess-Titanium (Copper)



Diameter of Thread: 2.4mm

Diameter of Head: 4.0mm

Drill Bit for Threaded Hole: 1.8mm

For Use with 2.4mm Hexagonal Screwdriver

MW/#	SECUROS#	LENGTH (mm)
042300	002684	6
■ 370025	005138	7
042301	002685	8
■ 370027	005140	9
031038	001043	10
■ 370028	005141	11
031039	001044	12
■ 370029	005142	13
031040	001045	14
031041	001046	16
031042	001047	18
031043	001048	20
031044	001049	22
031045	001050	24
031046	001051	26
031047	001052	28
031048	001053	30
031049	001054	32
031050	001055	34
031051	001056	36
031052	001057	38
031053	001058	40

■ special order item

2.7mm Cortical Screws

2.7mm Cortical Screw, Self-Tapping, Hexagonal Recess-Stainless Steel



Diameter of Thread: 2.7mm

Diameter of Head: 5.0mm

Drill Bit for Threaded Hole: 2.0mm

For Use with 2.7/3.5/4.0mm Hexagonal Screwdriver

MWI#	SECUIROS#	LENGTH (mm)
031116	002540	6
029166	001878	8
029167	001879	10
029168	001880	12
029169	001881	14
029170	001882	16
029171	001883	18
029172	001630	20
029173	001631	22
029174	001632	24
029175	001633	26
029176	001634	28
029177	001635	30
029178	001636	32
031117	002549	34
031152	002550	36
035974	003554	38
042294	002551	40

2.7mm Cortical Screw, Self-Tapping, Hexagonal Recess-Titanium (Blue)



Diameter of Thread: 2.7mm

Diameter of Head: 5.0mm

Drill Bit for Threaded Hole: 2.0mm

For Use with 2.7/3.5/4.0mm Hexagonal Screwdriver

MWI#	SECUIROS#	LENGTH (mm)
045630	003484	6
049440	003193	8
031054	001059	10
031055	001060	12
031056	001061	14
031057	001062	16
031058	001063	18
031059	001064	20
031060	001065	22
031061	001066	24
031062	001067	26
031063	001068	28
042074	001069	30
042075	001070	32
042076	001071	34
042077	001072	36
042078	001073	38
042079	001074	40



3.5mm Cortical Screws

3.5mm Cortical Screw, Self-Tapping, Hexagonal Recess-Stainless Steel



Diameter of Thread: 3.5mm

Diameter of Head: 6.0mm

Drill Bit for Threaded Hole: 2.5mm

For Use with 2.7/3.5/4.0mm Hexagonal Screwdriver

MWI#	SECUROS#	LENGTH (mm)
029200	001885	10
029201	001886	12
029202	001887	14
029203	001888	16
029204	001889	18
029205	001890	20
029207	001891	22
029208	001892	24
029209	001893	26
029210	001894	28
029211	001895	30
029212	001896	32
029213	001897	34
029214	001898	36
029215	001899	38
029216	002101	40

3.5mm Cortical Screw, Self-Tapping, Hexagonal Recess- Titanium (Gold)



Diameter of Thread: 3.5mm

Diameter of Head: 6.0mm

Drill Bit for Threaded Hole: 2.5mm

For Use with 2.7/3.5/4.0mm Hexagonal Screwdriver

MWI#	SECUROS#	LENGTH (mm)
042080	001075	10
031070	001076	12
031071	001077	14
031072	001078	16
031073	001079	18
031074	001080	20
031075	001081	22
031076	001082	24
031077	001083	26
031078	001084	28
031079	001085	30
042082	001086	32
042083	001087	34
042084	001088	36
042085	001089	38
042086	001090	40

Patella Luxation Spacers

Tubular PLX Spacers - Stainless Steel



MWI#	SECUROS#	LENGTH (mm)
■ 372167	004745	2
■ 372168	004746	4
■ 372169	004747	6

Tubular PLX Spacers - Titanium



MWI#	SECUROS#	LENGTH (mm)	COLOR
045527	004708	2	Gold
045061	004709	4	Blue
045062	004710	6	Light Blue

PLX Spacers - Stainless Steel



MWI#	SECUROS#	LENGTH (mm)
042429	004329	2
042431	004331	4
042433	004333	6

PLX Spacers - Titanium



MWI#	SECUROS#	LENGTH (mm)	COLOR
042430	004330	2	Gold
042432	004332	4	Gold
042434	004334	6	Gold

Velocity Bioactive Synthetic Bone Graft (Sterile)



Particulate

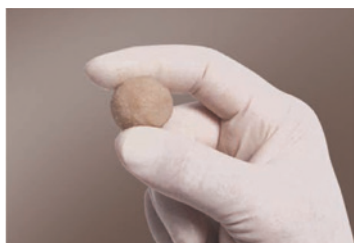

Putty

MWI#	SECUROS#	PRODUCT DESCRIPTION	VOLUME PER BOX
032390	000841	Particulate	Two 2.5cc
042333	003623	Putty	1.0cc
035245	003756	Putty	2.5cc
032391	000842	Putty	5.0cc

Velocity Bioactive Synthetic Bone Graft is comprised of 100% synthetic bioactive materials that are composed from elements that naturally occur in the body. The carrier is rapidly removed from the site through enzymatic activity leaving behind a bioactive material capable of regenerating new bone from existing bone. Both the Velocity Putty and Particulate are osteostimulative; defined as the active stimulation of osteoblast proliferation and differentiation due to ionic dissolution products released from Velocity during absorption.

INSTRUMENTS

Instruments for TTA



MWI#	SECUROS#	PRODUCT DESCRIPTION
031140	003095	TTA Plate Bender



MWI#	SECUROS#	PRODUCT DESCRIPTION	LENGTH (")
031144	001014	TTA T-Handle	3



MWI#	SECUROS#	PRODUCT DESCRIPTION
044669	000723	3mm TTA Spacer
031148	002930	6mm TTA Spacer
031149	002931	9mm TTA Spacer
031146	002922	12mm TTA Spacer
045407	004175	16mm TTA Spacer

Drill Bits

Jacobs Chuck Coupling (BITE Bit, Titanium Nitride Coated)



MWI#	SECUROS#	DIAMETER (mm)	TOTAL LENGTH (mm)	FLUTE LENGTH (mm)	RECOMMENDED SCREWS (mm)
031139	001017	1.8	131	26	2.4
028995	002036	2.0	86	50	2.7
028996	002037	2.5	96	50	3.5

Quick Coupling (BITE Bit, Titanium Nitride Coated)



MWI#	SECUROS#	DIAMETER (mm)	TOTAL LENGTH (mm)	FLUTE LENGTH (mm)	RECOMMENDED SCREWS (mm)
036059	000395	1.8	140	32	2.4
029010	001018	2.0	100	22	2.7
029011	001019	2.5	110	32	3.5

Drill Guides

Double Drill Guides



MWI #	SECUROS #	PRODUCT DESCRIPTION
055050	003824	1.8/2.4mm Double Drill Guide
031195	001022	2.0/2.7mm Double Drill Guide
030996	001023	2.5/3.5mm Double Drill Guide

Depth Gauges



MWI#	SECUROS#	PRODUCT DESCRIPTION	MEASURES UP TO (mm)	MEASUREMENT INCREMENTS (mm)
029097	002049	1.5/2.0/2.4mm Depth Gauge	30	2 & 5
029098	001020	2.7/3.5/4.0mm Depth Gauge	60	2 & 5
090001	005329	2.7/3.5/4.0mm Depth Gauge	60	1

Screwdrivers, Handles & Shafts

Screwdrivers (Includes holding sleeve)



Cruciform

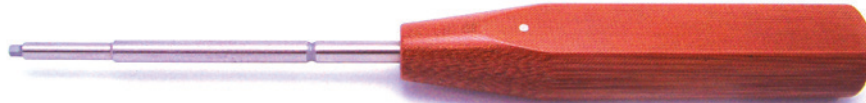

Hexagonal

MWI#	SECUROS#	PRODUCT DESCRIPTION	LENGTH (")
042073	001026	1.5/2.0/2.4mm Cruciform Screwdriver	7
035880	003237	2.4mm Hexagonal Screwdriver	7
029524	001024	2.7/3.5/4.0mm Hexagonal Screwdriver	7.5

Screwdriver Shafts (Quick Coupling, Includes holding sleeve)

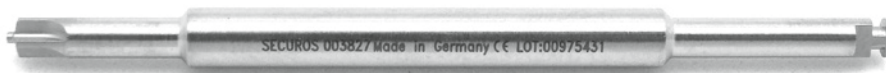

003827



001025

MWI#	SECUROS#	PRODUCT DESCRIPTION	FOR USE WITH	LENGTH (")
056007	003827	1.5/2.0/2.4mm Cruciform Screwdriver Shaft	Mini QC Handle	2
055102	003904	2.4mm Hexagonal Screwdriver Shaft	Small, Large, Silicone QC Handles	4
029525	001025	2.7/3.5/4.0mm Hexagonal Screwdriver Shaft	Small, Large, Silicone QC Handles	4

Screwdrivers, Handles & Shafts

Screwdriver Handles (Quick Coupling)

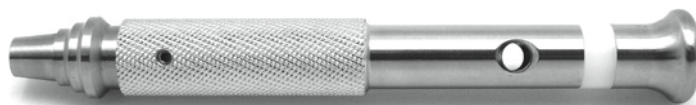

MWI#	SECUIROS#	PRODUCT DESCRIPTION	ACCOMMODATES	LENGTH (")
042033	000123	Mini Handle	1.5/2.0/2.4mm Cruciform Screwdriver Shaft	4.25



MWI#	SECUIROS#	PRODUCT DESCRIPTION	ACCOMMODATES	LENGTH (")
029529	007003	Small Handle	2.4mm & 2.7/3.5/4.0mm Hexagonal Screwdriver Shafts	4.5



MWI#	SECUIROS#	PRODUCT DESCRIPTION	ACCOMMODATES	LENGTH (")
029528	001916	Large Handle	2.4mm & 2.7/3.5/4.0mm Hexagonal Screwdriver Shafts	6



MWI#	SECUIROS#	PRODUCT DESCRIPTION	ACCOMMODATES	LENGTH (")
052748	007180	Silicone Handle	2.4mm & 2.7/3.5/4.0mm Hexagonal Screwdriver Shafts	5.5

Screwdriver Holding Sleeves



005502

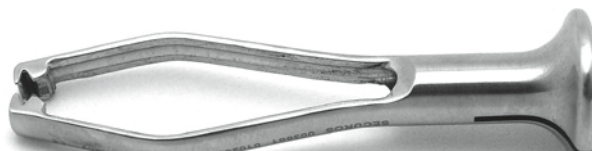

003661

MWI#	SECUIROS#	PRODUCT DESCRIPTION
052741	005502	1.5/2.0mm Standard Hexagonal Screwdriver Holding Sleeve
036057	003661	2.4mm Screwdriver Holding Sleeve
043904	002190	2.7/3.5/4.0mm Hexagonal Screwdriver Holding Sleeve

Bone Reduction Forceps



MWI#	SECUROS#	FEATURE	LENGTH (")
035878	840345	Ratchet, Curved, Pointed Tips	5.5



MWI#	SECUROS#	FEATURE	LENGTH (")
045001	840346	Ratchet, Curved, Pointed Tips	8.5

TTA Cage Cutter (For use with Cut-to-Length Cages)

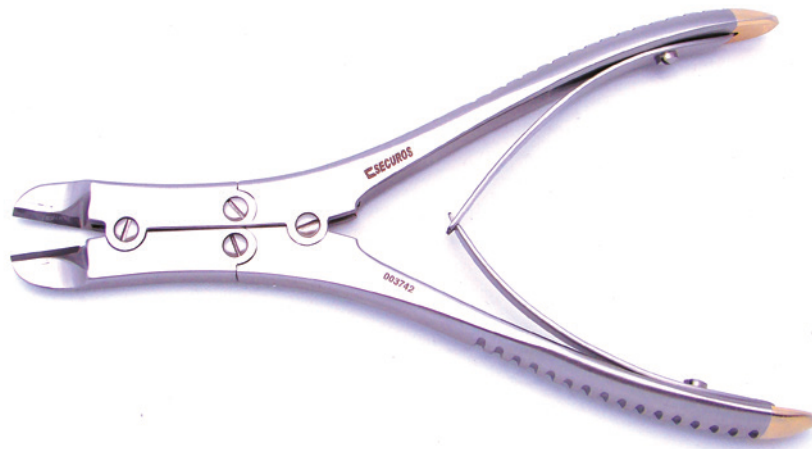

MWI#	SECUROS#	PRODUCT DESCRIPTION	FEATURE	LENGTH (")
042400	003742	TTA Cage Cutter	Tungsten Carbide Inserts	6.25

Instruments for use with Standard TTA Plates

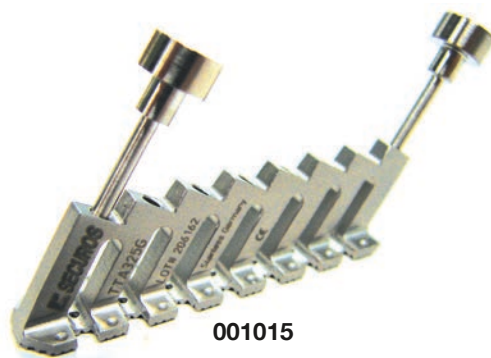

* Posts shown are not included.

MWI#	SECUROS#	PRODUCT DESCRIPTION
045519	000724	Fork Drill Guide - 4 Holes
031141	001015	Fork Drill Guide - 8 Holes

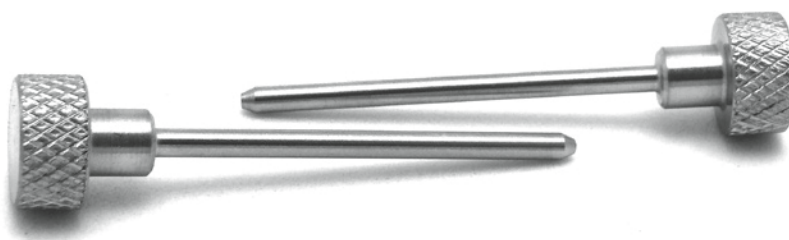

MWI#	SECUROS#	PRODUCT DESCRIPTION
031145	002920	1.7mm Posts (Pack of 2) for 1.8mm Drill Bit
031147	002921	1.9mm Posts (Pack of 2) for 2.0mm Drill Bit



MWI#	SECUROS#	PRODUCT DESCRIPTION
031143	002069	Fork Inserter



MWI#	SECUROS#	PRODUCT DESCRIPTION	HEAD DIAMETER (")	WEIGHT (g)	LENGTH (")
048375	840400	Lucae Mallet	1	250	7.75

Sterilization Containers

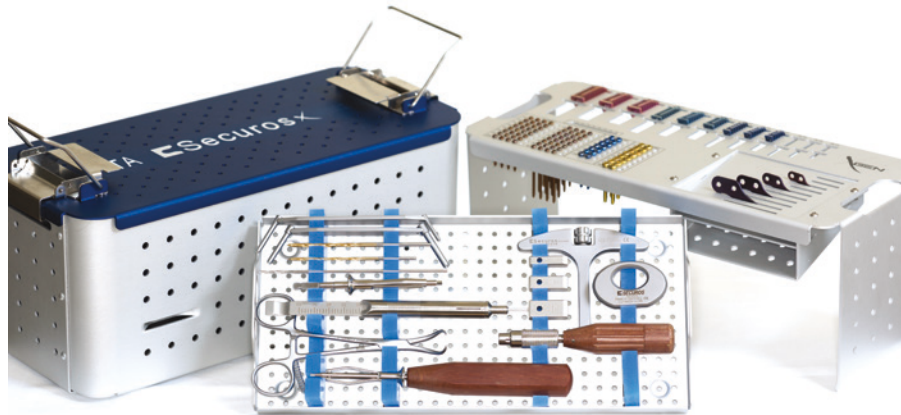

MWI#	SECUROS#	PRODUCT DESCRIPTION	LENGTH (")	WIDTH (")	HEIGHT (")
042439	005324	XGEN TTA Sterilization Container	13.25	6	5.25
ACCOMMODATES					
Cages 2 ea.: 3x13mm, 3x16mm, 3x19mm, 6x16mm, 6x19mm, 6x22mm, 9x19mm, 9x22mm, 9x25mm, 12x22mm, 12x25mm, 12x28mm, Plates 2 ea.: 3-2 Hole, 4-2 Hole, 5-2 Hole, 6-3 Hole, 7-3 Hole, 8-3 Hole, 2.4mm Screws 5 ea.: 10mm-40mm (Increments of 2mm), 2.7mm Screws 3 ea.: 14mm-26mm (Increments of 2mm), 3.5mm Screws 3 ea.: 16mm-30mm (Increments of 2mm), TTA Plate Bender, TTA T-Handle, TTA Spacers 1 ea.: 6mm, 9mm, 12mm, Drill Bits 1 ea.: 1.8mm, 2.0mm, 2.5mm, Drill Guides: 2, 2.7/3.5/4.0mm Depth Gauge, 5.5" Bone Reduction Forceps, 2.4mm Hexagonal Screwdriver, Small QC Handle, 2.7/3.5/4.0mm Hexagonal Screwdriver Shaft					

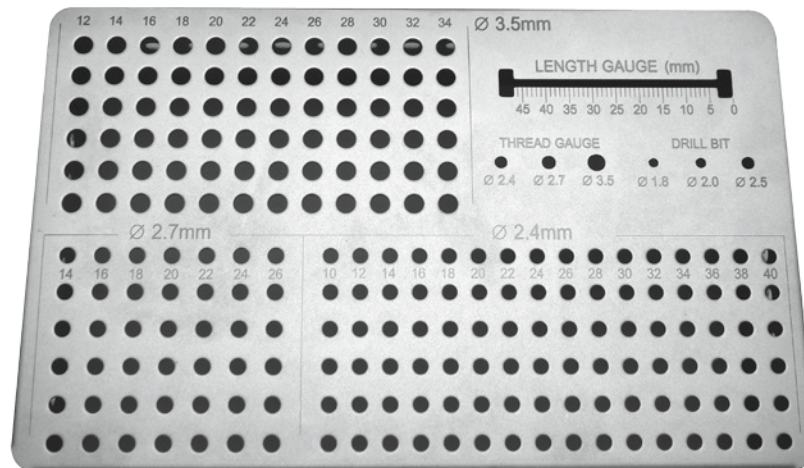

MWI#	SECUROS#	PRODUCT DESCRIPTION	LENGTH (")	WIDTH (")	HEIGHT (")
042069	000883	Screw Rack for 2.4/2.7/3.5mm Cortical Screws	6.5	4	2.25
ACCOMMODATES					
2.4mm Screws 6 ea.: 10mm-40mm (Increments of 2mm), 2.7mm Screws 6 ea.: 14mm-26mm (Increments of 2), 3.5mm Screws 6 ea.: 12mm-34mm (Increments of 2)					

Reference Materials

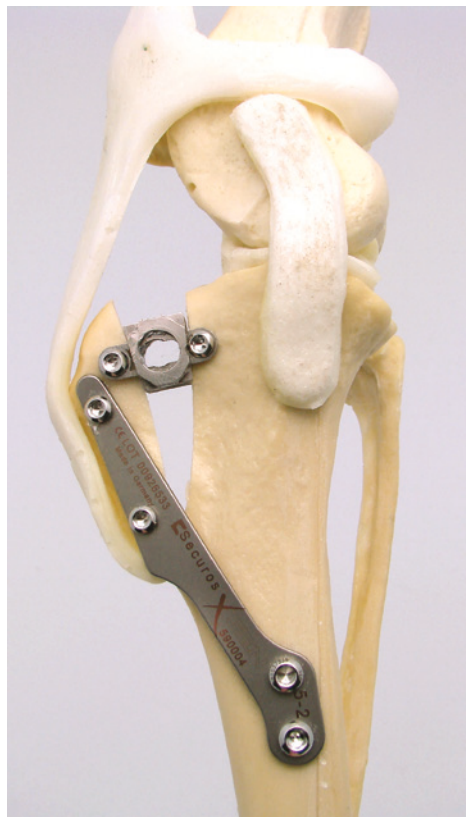

000377

MWI#	SECUROS#	PRODUCT DESCRIPTION
■ 276414	000377	XGEN Tibial Tuberosity Advancement Bone Model - Stainless Steel
■ 388997	005493	Tibial Tuberosity Advancement Pre-Op Planning Guide
036013	003097	XGEN Tibial Tuberosity Advancement Instructional DVD





SECUROS TPLO

- Anatomically **precontoured** TPLO Plate, featuring ceramic blasted anti-glare finish
- Variety of **low profile** plate sizes to fit varying patient anatomy
- **Ergonomic pneumatic** TPLO Saw does not require specialized blade adapter
- **Multiple** TPLO blade sizes and style, available for surgeon **preference**



TPLO Clinical Cases

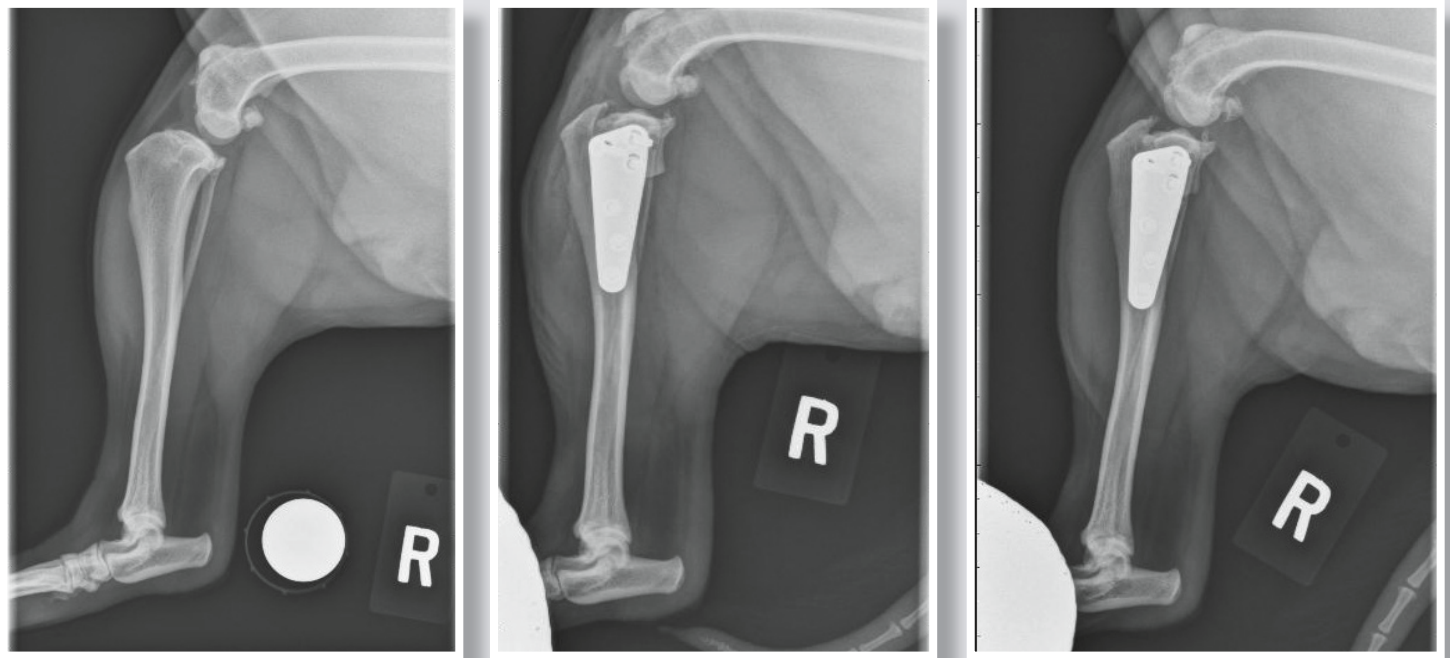

Radiographs provided by Veterinary Specialty Hospital—San Diego, CA



IMPLANTS

TPLO Plates

TPLO Plates (Anatomically Pre-Contoured) - Stainless Steel

MWI#	SECUROS#	PRODUCT DESCRIPTION	# OF HOLES	THICKNESS (mm)
042403	003784	2.0mm Left	6	1.5
042402	003783	2.0mm Right	6	1.5
035925	003243	2.7mm Left	6	2.2
035932	003244	2.7mm Right	6	2.2
036063	003658	2.7mm Broad Left	6	2.2
036068	003657	2.7mm Broad Right	6	2.2
031022	001129	3.5mm Left	6	2.2
031021	001130	3.5mm Right	6	2.2
035250	000776	3.5mm Broad Left	8	2.2
035868	000775	3.5mm Broad Right	8	2.2



TPLO Plates

TPLO Plates (Anatomically Pre-Contoured) - Titanium (Gold)



MWI#	SECUROS#	PRODUCT DESCRIPTION	# OF HOLES	THICKNESS (mm)
042416	003973	3.5mm Left	6	2.6
042417	003974	3.5mm Right	6	2.6

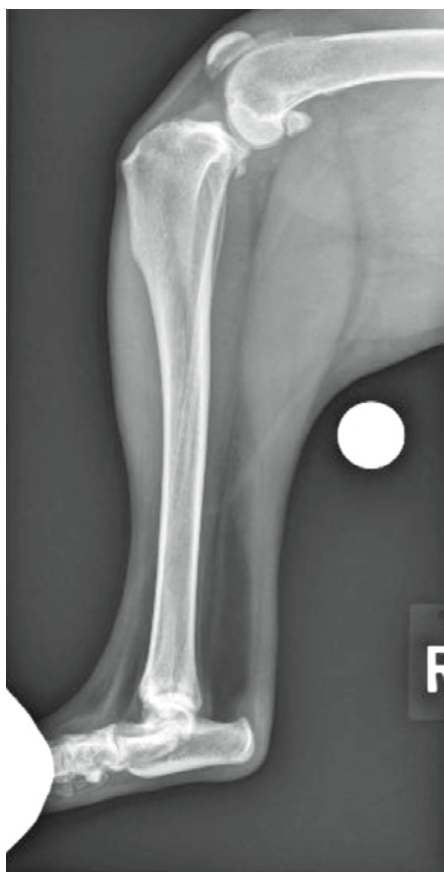

Radiographs provided by Veterinary Specialty Hospital—San Diego, CA

2.0mm Cortical Screws

2.0mm Cortical Screw, Self-Tapping, Cruciform Recess-Stainless Steel



Diameter of Thread: 2.0mm

Diameter of Head: 3.5mm

Drill Bit for Threaded Hole: 1.5mm

For Use with 1.5/2.0mm Cruciform Screwdriver

MWI#	SECUROS#	LENGTH (mm)
042132	100009	6
042133	100010	8
042134	100011	10
042140	100022	12
■ 370036	100048	13
042135	100012	14
042136	100013	16
042137	100014	18
042138	100016	20
044009	100017	22
042139	100018	24
055060	100019	26
044010	100020	28
049129	100021	30
045211	100023	32
045214	100024	34
049130	100025	36
■ 370037	100049	38
■ 370038	100050	40

2.0mm Cortical Screw, Self-Tapping, Hexagonal Recess-Stainless Steel

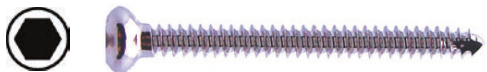

Diameter of Thread: 2.0mm

Diameter of Head: 4.0mm

Drill Bit for Threaded Hole: 1.5mm

For Use with 2.0mm Hexagonal Screwdriver

MWI#	SECUROS#	LENGTH (mm)
029135	001853	6
029136	001854	8
029137	001855	10
029138	001856	12
■ 370039	005123	13
029139	001857	14
029140	001858	16
029141	001859	18
029142	001860	20
029143	001861	22
029144	001862	24
029145	001863	26
029146	001864	28
029147	001865	30
029148	001866	32
■ 370040	005124	34
■ 370041	005125	36
■ 370042	005126	38
■ 370043	005127	40

■ special order item

2.7mm Cortical Screws

2.7mm Cortical Screw, Self-Tapping, Hexagonal Recess-Stainless Steel



Diameter of Thread: 2.7mm

Diameter of Head: 5.0mm

Drill Bit for Threaded Hole: 2.0mm

For Use with 2.7/3.5/4.0mm Hexagonal Screwdriver

MWl#	SECUROS#	LENGTH (mm)
031116	002540	6
029166	001878	8
029167	001879	10
029168	001880	12
029169	001881	14
029170	001882	16
029171	001883	18
029172	001630	20
029173	001631	22
029174	001632	24
029175	001633	26
029176	001634	28
029177	001635	30
029178	001636	32
031117	002549	34
031152	002550	36
035974	003554	38
042294	002551	40
048237	004450	42
048238	004451	44
042295	002552	45
048239	004452	46
■ 370044	004453	48
042296	002553	50
■ 370045	005143	55

2.7mm Cortical Screw, Self-Tapping, Hexagonal Recess-Titanium (Light Blue)



Diameter of Thread: 2.7mm

Diameter of Head: 5.0mm

Drill Bit for Threaded Hole: 2.0mm

For Use with 2.7/3.5/4.0mm Hexagonal Screwdriver

MWl#	SECUROS#	LENGTH (mm)
045630	003484	6
049440	003193	8
031054	001059	10
031055	001060	12
031056	001061	14
031057	001062	16
031058	001063	18
031059	001064	20
031060	001065	22
031061	001066	24
031062	001067	26
031063	001068	28
042074	001069	30
042075	001070	32
042076	001071	34
042077	001072	36
042078	001073	38
042079	001074	40
■ 370046	005151	42
■ 370047	005152	44
048162	003196	45
■ 370048	005153	46
■ 370049	005154	48
048163	003197	50
■ 370050	005155	55

■ special order item



3.5mm Cortical Screws

3.5mm Cortical Screw, Self-Tapping, Hexagonal Recess-Stainless Steel



Diameter of Thread: 3.5mm

Diameter of Head: 6.0mm

Drill Bit for Threaded Hole: 2.5mm

For Use with 2.7/3.5/4.0mm Hexagonal Screwdriver

MWI#	SECUROS#	LENGTH (mm)	MWI#	SECUROS#	LENGTH (mm)
029200	001885	10	029214	001898	36
029201	001886	12	029215	001899	38
029202	001887	14	029216	002101	40
029203	001888	16	042451	004470	42
029204	001889	18	042452	004471	44
029205	001890	20	031119	002593	45
029207	001891	22	036060	004472	46
029208	001892	24	042453	004473	48
029209	001893	26	031120	002592	50
029210	001894	28	031121	002594	55
029211	001895	30	036197	002595	60
029212	001896	32	042382	006068	65
029213	001897	34	042384	006069	70

3.5mm Cortical Screw, Self-Tapping, Hexagonal Recess-Titanium (Gold)



Diameter of Thread: 3.5mm

Diameter of Head: 6.0mm

Drill Bit for Threaded Hole: 2.5mm

For Use with 2.7/3.5/4.0mm Hexagonal Screwdriver

MWI#	SECUROS#	LENGTH (mm)	MWI#	SECUROS#	LENGTH (mm)
042080	001075	10	042084	001088	36
031070	001076	12	042085	001089	38
031071	001077	14	042086	001090	40
031072	001078	16	042319	003198	42
031073	001079	18	042320	003199	44
031074	001080	20	044929	003480	45
031075	001081	22	044026	003200	46
031076	001082	24	044027	003201	48
031077	001083	26	055044	003481	50
031078	001084	28	044930	003482	55
031079	001085	30	048177	003483	60
042082	001086	32	■ 372210	005169	65
042083	001087	34	■ 372211	005170	70

■ special order item

4.0mm Cancellous Screws

4.0mm Cancellous Screw, Fully Threaded, Hexagonal Recess-Stainless Steel



Diameter of Thread: 4.0mm

Diameter of Head: 6.0mm

Drill Bit for Threaded Hole: 2.0mm

For Use with 2.7/3.5/4.0mm Hexagonal Screwdriver

MWI#	SECUROS#	LENGTH (mm)
042043	000441	10
048114	000442	12
048500	000443	14
■ 372046	000444	16
■ 372047	000445	18
048501	000446	20
■ 372048	000447	22
046112	000448	24
■ 372049	000449	26
■ 372172	000450	28
■ 372173	000451	30
042045	000452	32
■ 372050	000453	34

MWI#	SECUROS#	LENGTH (mm)
■ 372051	000454	36
■ 372052	000455	38
■ 372174	000456	40
■ 372053	000413	42
■ 372054	000414	44
046113	000474	45
042041	000439	46
■ 372055	000440	48
■ 372056	000458	50
■ 372057	000459	55
■ 048502	000460	60
■ 372058	005171	65
■ 372059	005172	70

4.0mm Cancellous Screw, Fully Threaded, Hexagonal Recess-Titanium (Gray)



Diameter of Thread: 4.0mm

Diameter of Head: 6.0mm

Drill Bit for Threaded Hole: 2.0mm

For Use with 2.7/3.5/4.0mm Hexagonal Screwdriver

MWI#	SECUROS#	LENGTH (mm)
■ 372060	005183	10
■ 372061	005184	12
■ 372062	005185	14
■ 372063	005186	16
■ 372064	005187	18
■ 372065	005188	20
■ 372066	005189	22
■ 372067	005190	24
■ 372068	005191	26
■ 372069	005192	28
■ 372070	005193	30
■ 372071	005194	32
■ 372072	005195	34

MWI#	SECUROS#	LENGTH (mm)
■ 372073	005196	36
■ 372074	005197	38
■ 372075	005198	40
■ 372076	005199	42
■ 372077	005200	44
■ 372078	005201	45
■ 372079	005202	46
■ 372080	005203	48
■ 372081	005204	50
■ 372082	005205	55
■ 372083	005206	60
■ 372084	005207	65
■ 372085	005208	70



■ special order item

INSTRUMENTS

Bending Instruments



MWI#	SECUROS#	PRODUCT DESCRIPTION	FOR USE WITH	LENGTH (")
042253	002056	1.5/2.0mm Plate Bending Iron	2.0mm TPLO Plates	4.75



MWI#	SECUROS#	PRODUCT DESCRIPTION	LENGTH (")
390151	002510	2.7/3.5mm TPLO Plate Bending Iron (#1)	9
045471	002511	2.7/3.5mm TPLO Plate Bending Iron (#2)	9
056030	001142	2.7/3.5mm TPLO Plate Bending Iron Set of 2	9



MWI#	SECUROS#	PRODUCT DESCRIPTION	FOR USE WITH	LENGTH (")
042314	002948	3.5/4.5mm Plate Bending Iron	2/7/3.5 mm TPLO Plates	9.75

Bending Instruments



MWI#	SECUROS#	PRODUCT DESCRIPTION	FOR USE WITH	LENGTH (")
045449	002063	2.4/2.7/3.5mm Medium Bending Pliers	2.7/3.5mm TPLO Plates	8.75



MWI#	SECUROS#	PRODUCT DESCRIPTION	FOR USE WITH	LENGTH (")
044054	002064	3.5/4.5mm Large Bending Pliers	2.7/3.5mm TPLO Plates	9.75



MWI#	SECUROS#	PRODUCT DESCRIPTION	LENGTH (")
043932	003027	Curved Castroviejo Caliper	3.5

Drill Bits

Jacobs Chuck Coupling (BITE Bit, Titanium Nitride Coated)



MWI#	SECUROS#	DIAMETER (mm)	TOTAL LENGTH (mm)	FLUTE LENGTH (mm)	RECOMMENDED SCREWS (mm)
028994	002035	1.5	70	22	2.0
028995	002036	2.0	86	50	2.7, 4.0
028996	002037	2.5	96	50	3.5

Quick Coupling (BITE Bit, Titanium Nitride Coated)



MWI#	SECUROS#	DIAMETER (mm)	TOTAL LENGTH (mm)	FLUTE LENGTH (mm)	RECOMMENDED SCREWS (mm)
029009	002044	1.5	85	19	2.0
029010	001018	2.0	100	22	2.7, 4.0
029011	001019	2.5	110	32	3.5

Drill Guides

Double Drill Guides



MWI#	SECUROS#	PRODUCT DESCRIPTION
030970	002067	1.5/2.0mm Double Drill Guide
031195	001022	2.0/2.7mm Double Drill Guide
030996	001023	2.5/3.5mm Double Drill Guide

Compressional Drill Guides



MWI#	SECUROS#	PRODUCT DESCRIPTION
029016	001902	2.0mm Compressional Drill Guide
042238	001903	2.7mm Compressional Drill Guide
029018	001904	3.5mm Compressional Drill Guide

Universal Drill Guide



MWI#	SECUROS#	PRODUCT DESCRIPTION
042267	002279	3.5mm Universal Drill Guide

Depth Gauges

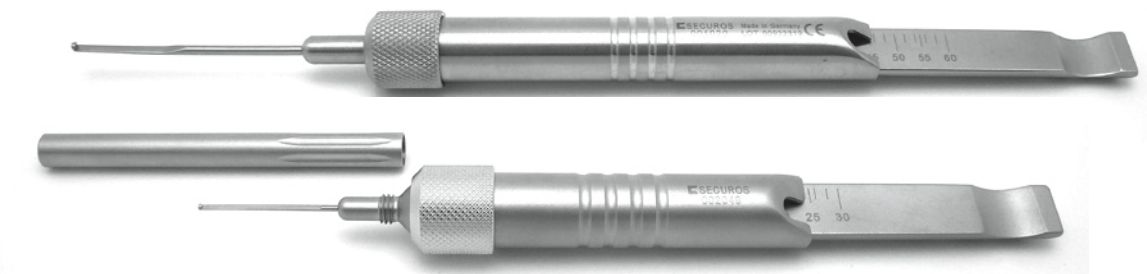

MWI#	SECUROS#	PRODUCT DESCRIPTION	MEASURES UP TO (mm)	MEASUREMENT INCREMENTS (mm)
029097	002049	1.5/2.0/2.4mm Depth Gauge	30	2 & 5
029098	001020	2.7/3.5/4.0mm Depth Gauge	60	2 & 5
090001	005329	2.7/3.5/4.0mm Depth Gauge	60	1

Screwdrivers, Handles, Shafts, & Taps

Screwdrivers (Includes holding sleeve)



Cruciform



Hexagonal

MWI#	SECUROS#	PRODUCT DESCRIPTION	LENGTH (")
042292	002504	1.5/2.0mm Hexagonal Screwdriver	6.75
042073	001026	1.5/2.0/2.4mm Cruciform Screwdriver	7
029524	001024	2.7/3.5/4.0mm Hexagonal Screwdriver	7.75

Screwdrivers, Handles, Shafts, & Taps

Screwdriver Shafts (Quick Coupling, Includes holding sleeve)

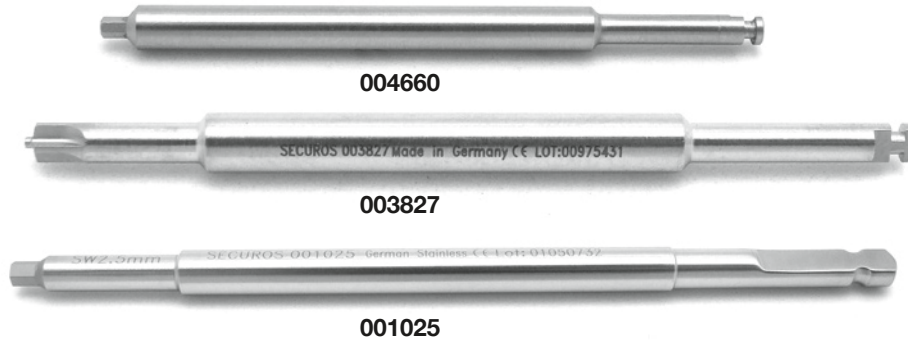

MWI#	SECUROS#	PRODUCT DESCRIPTION	FOR USE WITH	LENGTH (")
055058	004660	1.5/2.0mm Hexagonal Screwdriver Shaft	Mini QC Handle	2
056007	003827	1.5/2.0/2.4mm Cruciform Screwdriver Shaft	Mini QC Handle	2
029525	001025	2.7/3.5/4.0mm Hexagonal Screwdriver Shaft	Small, Large, Silicone QC Handles	4

Screwdriver Handles (Quick Coupling)



MWI#	SECUROS#	PRODUCT DESCRIPTION	ACCOMMODATES	LENGTH (")
042033	000123	Mini Handle	1.5/2.0mm Hexagonal and 1.5/2.0/2.4mm Cruciform Screwdriver Shafts	4.25



MWI#	SECUROS#	PRODUCT DESCRIPTION	ACCOMMODATES	LENGTH (")
029529	007003	Small Handle	2.7/3.5/4.0mm Hexagonal Screwdriver Shaft	4.5



MWI#	SECUROS#	PRODUCT DESCRIPTION	ACCOMMODATES	LENGTH (")
029528	001916	Large Handle	2.7/3.5/4.0mm Hexagonal Screwdriver Shaft	6

Screwdrivers, Handles, Shafts, & Taps

Screwdriver Handles (Quick Coupling)



MWI#	SECUROS#	PRODUCT DESCRIPTION	ACCOMMODATES	LENGTH (")
052748	007180	Silicone Handle	2.7/3.5/4.0mm Hexagonal Screwdriver Shaft	5.5

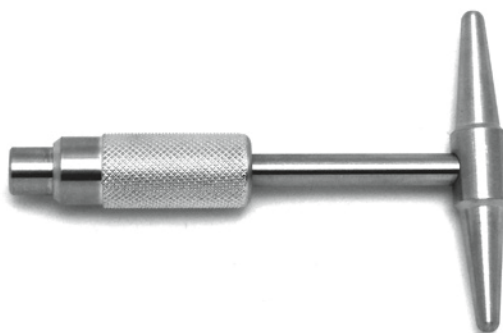

MWI#	SECUROS#	PRODUCT DESCRIPTION	ACCOMMODATES	LENGTH (")
029530	001918	T-Handle	4.0mm Cancellous Screw Tap	3.25

Screwdriver Holding Sleeves



005502



003661

MWI#	SECUROS#	PRODUCT DESCRIPTION
052741	005502	1.5/2.0mm Hexagonal Screwdriver Holding Sleeve
036057	003661	2.4mm Screwdriver Holding Sleeve
043904	002190	2.7/3.5/4.0mm Hexagonal Screwdriver Shaft Holding Sleeve

Tap for Cancellous Screws



MWI#	SECUROS#	DIAMETER (mm)	TOTAL LENGTH (mm)	THREAD LENGTH (mm)	RECOMMENDED SCREWS (mm)
042241	001911	4.0	110	45	4.0

TPLO Jig & Pins

TPLO Jig



MWI#	SECUROS#	PRODUCT DESCRIPTION
042437	004356	TPLO Jig
042378	004601	Replacement Screw for TPLO Jig

Pins for TPLO Jig



Smooth

Partially Threaded

MWI#	SECUROS#	STYLE	LENGTH (")
5/64"			
031011	002986	Smooth	4.5
029058	001236	Smooth	9
■ 372086	005485	Partially Threaded	4.5
029069	001258	Partially Threaded	9
1/16"			
044962	004270	Smooth	4.5
029057	001235	Smooth	9
042426	004271	Partially Threaded	4.5
029068	001257	Partially Threaded	9
3/32"			
048256	003587	Smooth	4.5
029059	001237	Smooth	9
035918	003586	Partially Threaded	4.5
029070	001259	Partially Threaded	9
7/64"			
■ 372087	005487	Smooth	4.5
029060	001238	Smooth	9
■ 372088	005486	Partially Threaded	4.5
029071	001260	Partially Threaded	9
1/8"			
031003	003099	Smooth	4.5
029061	001239	Smooth	9
031005	002985	Partially Threaded	4.5
029072	002956	Partially Threaded	9

■ special order item

Pin/Wire Cutters

Side Pin/Wire Cutters



MWI#	SECUROS#	PRODUCT DESCRIPTION	MAXIMUM PIN DIAMETER (")	LENGTH (")
048648	840843	"Hercules", Tungsten Carbide Inserts	7/64	9.25



MWI#	SECUROS#	MAXIMUM PIN DIAMETER (")	LENGTH (")
045561	003890	1/8	15



MWI#	SECUROS#	MAXIMUM PIN DIAMETER (")	LENGTH (")
045028	840407	1/4	18.5



MWI#	SECUROS#	PRODUCT DESCRIPTION	MAXIMUM PIN DIAMETER (")	LENGTH (")
036209	001458	Detachable Handles	1/4	18.5

Front Pin/Wire Cutters



MWI#	SECUROS#	MAXIMUM PIN DIAMETER (")	LENGTH (")
■ 276424	003759	1/8	10

■ special order item

Osteotomes

Pedifine Lambotte Osteotomes - Straight



MWI#	SECUROS#	WIDTH (mm)	LENGTH (")
042248	840254	4	5
045603	840255	6	5
045076	840257	8	5
045604	840259	10	5
045344	840260	12	5

Hoke Osteotomes - Straight



MWI#	SECUROS#	WIDTH (mm)	LENGTH (")
045277	840247	4	5.5
045074	840248	6	5.5
045366	840684	8	5.5
045084	840685	10	5.5
048271	840926	12	5.5

Mallets



840400



813670

MWI#	SECUROS#	PRODUCT DESCRIPTION	HEAD DIAMETER (")	WEIGHT (g)	LENGTH
048375	840400	Lucae Mallet	1	250	7.75
042163	813670	Mead Mallet (Includes Replacement Plastic Facings)	1	320	7.5
049220	840398	Replacement Plastic Facings for Mead Mallet - Packet of 2	-	-	-



Need your
Osteotomes sharpened?

Go to
www.securos.com
and visit our repair service page.

POWER EQUIPMENT

TPLO Pneumatic Saws & Accessories

TPLO Saw



000411



000835



000629

MWI#	SECUROS#	PRODUCT DESCRIPTION
042036	000411	TPLO Saw
036067	000835	Replacement Screw for TPLO Saw
042053	000629	1/8" Hex Key



MWI#	SECUROS#	PRODUCT DESCRIPTION
042037	000412	Hose for TPLO Saw (Schrader Connection)

TPLO Pneumatic Saws & Accessories

Slocum TPLO Saw



004423



004601

MWI#	SECUROS#	PRODUCT DESCRIPTION
■ 372089	004423	Slocum TPLO Saw
042378	004601	Replacement Screw for Slocum TPLO Jig/Adaptor
■ 372090	004424	Hose for Slocum TPLO Saw (Schrader Connection)



MWI#	SECUROS#	PRODUCT DESCRIPTION
052742	005096	Blade Adaptor for Slocum TPLO Saw

Universal Adaptors



MWI#	SECUROS#	PRODUCT DESCRIPTION
056026	000849	Oscillating Adaptor for TPLO Saw

TPLO Blades

Aesculap TPLO Blades



MWI#	SECUROS#	RADIUS (mm)	THICKNESS (mm)
■ 276403	004241	18	1.0
048760	004242	20	1.0
048755	004243	24	1.0
■ 372091	005488	27	1.0
045191	004245	30	1.0

Standard TPLO Blades

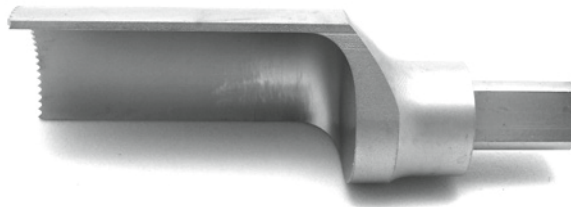

MWI#	SECUROS#	RADIUS (mm)	THICKNESS (mm)
049099	004781	12	1.0
048944	005318	15	1.0
045539	003913	18	1.0
055121	005071	21	1.0
042411	003912	24	1.2
045563	004244	27	1.2
056031	003993	30	1.2

Hub System TPLO Blades

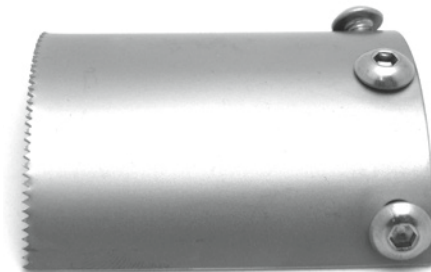

MWI#	SECUROS#	RADIUS (mm)	THICKNESS (mm)
056028	000408	18	1.0
035971	000409	24	1.0
056027	000410	30	1.0

■ special order item

TPLO Blades

Hub System Accessories

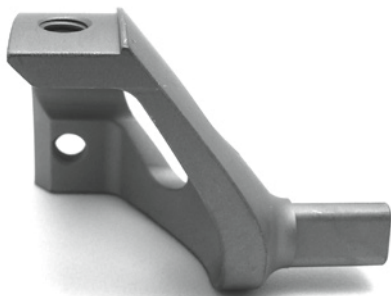

000406



000407



004171



000629

Method of Assembly



18mm Blade

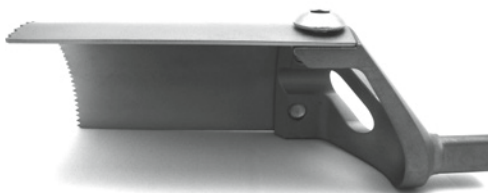

24mm Blade

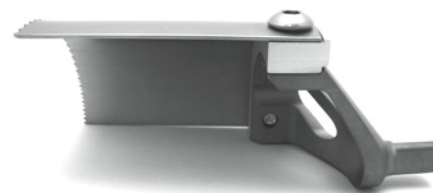

30mm Blade with Adapter

MWI#	SECUROS#	PRODUCT DESCRIPTION
042035	000406	TPLO Blade Hub
036193	000407	TPLO 30mm Blade Adaptor
056008	004171	Screw for 18mm and 24mm TPLO Blades
052744	004905	Screw for 30mm TPLO Blades
042053	000629	1/8" Hex Key

STERILIZATION CONTAINERS

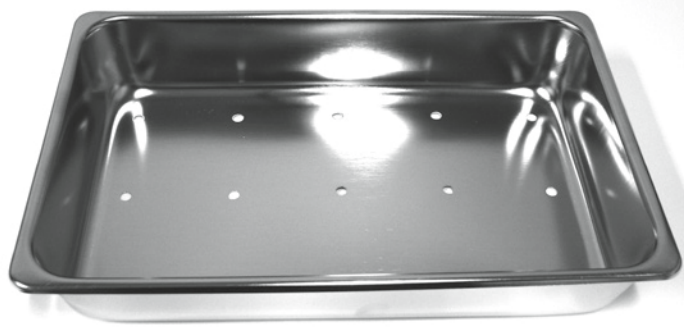

MWI#	SECUROS#	PRODUCT DESCRIPTION	LENGTH (")	WIDTH (")	HEIGHT (")
031093	001005	Perforated Tray	12.25	7.75	2.25
ACCOMMODATES					
Instruments					

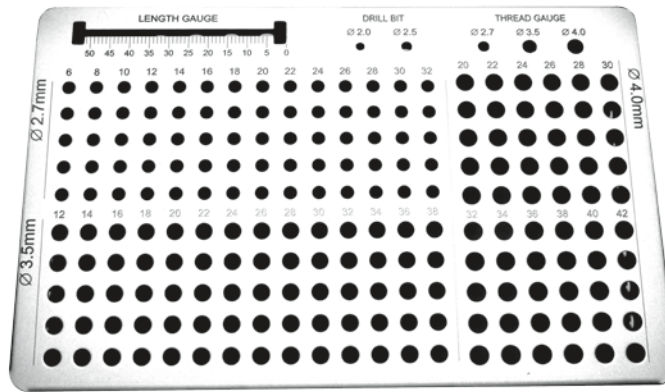

MWI#	SECUROS#	PRODUCT DESCRIPTION	LENGTH (")	WIDTH (")	HEIGHT (")
045560	000881	Screw Rack for 2.7/3.5mm Cortical & 4.0mm Cancellous Screws	6.5	4.25	2.25
ACCOMMODATES					
2.7mm Screws 5 ea.: 6mm-32mm (increments of 2mm), 3.5mm Screws 5 ea.: 12mm-38mm (increments of 2mm), 4.0mm Screws 5 ea.: 20mm-42mm (increments of 2mm)					

REFERENCE MATERIALS



MWI#	SECUROS#	PRODUCT DESCRIPTION
■	004574	TPLO Bone Model
056029	003765	Tibial Plateau Leveling Osteotomy Instructional DVD



SECUROS Meniscal Management

Complete line of instruments for **accurate** assessment of the mensci including:

- Blade handles, blades, forceps and rongeurs
- SENN, gelpi, hohmann and stifle retractors
- Meniscal probes, hooks and knives

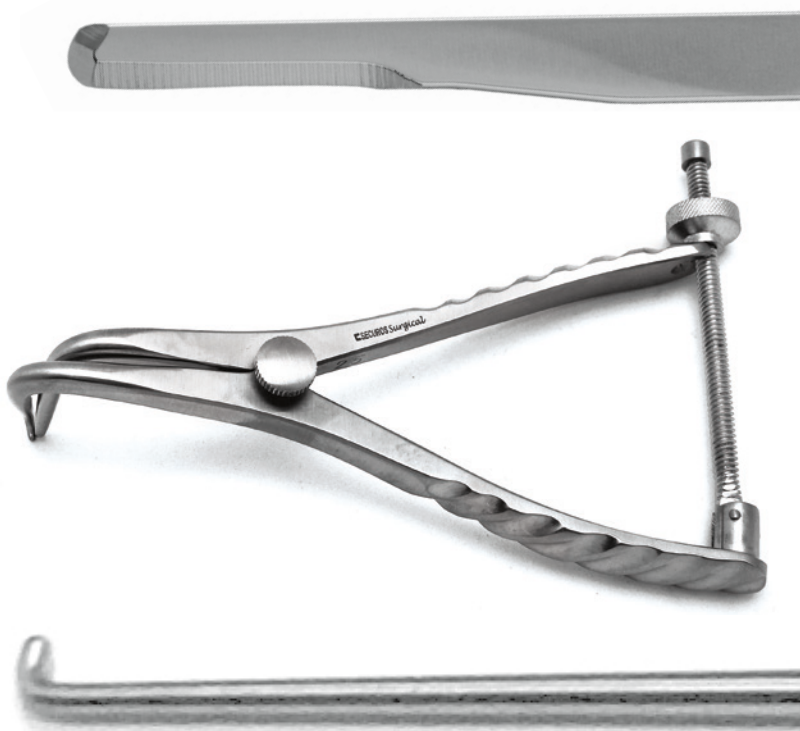

INSTRUMENTS

Blade Handle & Blades



001310



001311



001312

MWI#	SECUROS#	PRODUCT DESCRIPTION	LENGTH (")
031033	001310	Micro Beaver Blade Handle	4
031036	001311	Micro Beaver Blade Size 6400, Box of 12	1.25
031138	001312	Micro Beaver Blade Size 6700, Box of 12	1.25

Retractors

SENN Retractor



MWI#	SECUROS#	FEATURE	LENGTH (")
030961	815750	3 Prong, Sharp	6.25

Gelpi Retractors



MWI#	SECUROS#	LENGTH (")
035922	840178	3.5
036190	840179	4.5

Retractors

Hohmann Retractors



MWI#	SECUROS#	WIDTH (mm)	LENGTH (")
030962	840196	6	6.5
055014	813880	8	6.5



MWI#	SECUROS#	WIDTH (mm)	LENGTH (")
030963	813780	8	8.5
045558	840197	12	8
043804	840198	18	9



MWI#	SECUROS#	FEATURE	WIDTH (mm)	LENGTH (")
045113	001307	90 Degree	10	8

Retractors

Stifle Retractors



MWI#	SECUROS#	PRODUCT DESCRIPTION	FEATURE	LENGTH (")
048828	840188	Small Stifle Retractor	Speed Lock, Cross-Action Tips	5



MWI#	SECUROS#	PRODUCT DESCRIPTION	FEATURE	LENGTH (")
042170	840190	Stifle Retractor	Speed Lock, Cross-Action Tips	7



MWI#	SECUROS#	WIDTH (mm)	LENGTH (")
030964	840189	Wallace Knee Retractor	5.5

Probes and Hooks

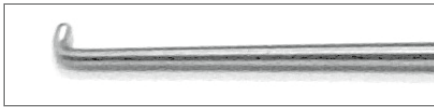

MWI#	SECUROS#	PRODUCT DESCRIPTION	TIP WIDTH (mm)	LENGTH (")
035928	002481	Meniscus Probe	2.5	9

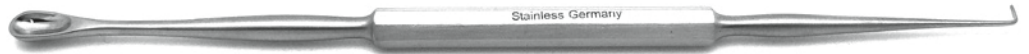

MWI#	SECUROS#	PRODUCT DESCRIPTION	LENGTH (")
044046	003249	Gross Ear Hook	5



MWI#	SECUROS#	PRODUCT DESCRIPTION	FEATURE	LENGTH (")
045518	000714	Hook Knife 3mm	90 Degree Tip	9.5

Forceps & Rongeurs



MWI#	SECUROS#	PRODUCT DESCRIPTION	FEATURE	LENGTH (")
048832	840494	Hartmann Alligator Forceps	1x2 Teeth	3.5



MWI#	SECUROS#	PRODUCT DESCRIPTION	FEATURE	LENGTH (")
048660	840863	Hartmann Mosquito Forceps	1x2 Teeth	3.5

Forceps & Rongeurs



MWI#	SECUROS#	PRODUCT DESCRIPTION	FEATURE	LENGTH (")
040399	840658	Halsted Mosquito Forceps	1x2 Teeth Straight	5

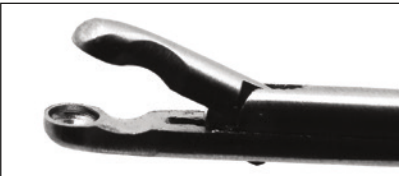

Hartmann Alligator

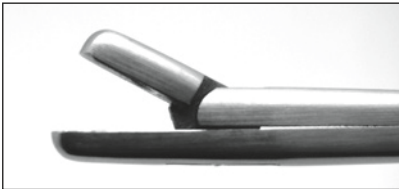

Caspar



MWI#	SECUROS#	PRODUCT DESCRIPTION	FEATURE	LENGTH (")
048418	840493	Hartmann Alligator Rongeur	2mm Cup	3.5
■ 370546	005507	Caspar Rongeur	2x10mm Bite, Straight	5

STERILIZATION CONTAINERS

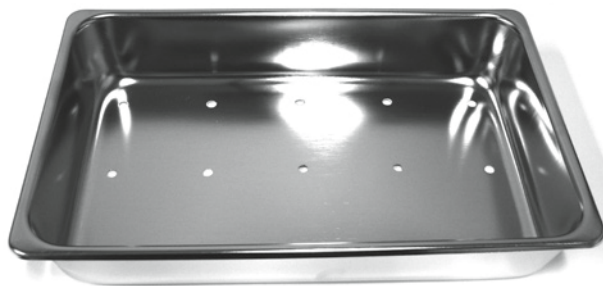

MWI#	SECUROS#	PRODUCT DESCRIPTION	LENGTH (")	WIDTH (")	HEIGHT (")
045520	001350	Perforated Tray	9	5	2

ACCOMMODATES

Instruments



SECUROS Patella Luxation Management

Complete line of instruments to accommodate surgery preference for Patellar Luxation Management including:

- **PLX Patella Saw** featuring an innovative locking design that eliminates the need for screws and wrench
- **Universal K-Wire Bender** featuring a unique design to accommodate 0.035", 0.045", 0.054" and 0.062" sizes for a 90° bend.
- Variety of **hand** and **power rasps** to deepen the trochlear groove and reshape wedge or block



Radiographs provided by Veterinary Specialty Hospital - San Diego, CA

IMPLANTS

Pins & Wires

9" Kirschner Wire (K-wire) (Smooth, Trocar/Trocar, Pack of 6)

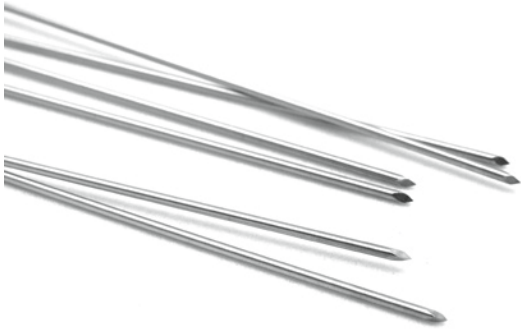

MWI#	SECUROS#	DIAMETER (")
029089	001277	0.035
029090	001278	0.045
029091	001279	0.054
029092	001280	0.062

9" Steinmann/Intramedullary Pins (Smooth, Trocar/Trocar)



MWI#	SECUROS#	DIAMETER (")
029057	001235	1/16
029058	001236	5/64
029059	001237	3/32
029060	001238	7/64
029061	001239	1/8

Orthopedic Wire (1oz Spool, Autoclavable)



MWI#	SECUROS#	DIAMETER
029080	001267	22 Gauge
029079	001266	20 Gauge
029078	001265	18 Gauge
029077	001264	16 Gauge

INSTRUMENTS

Patellar Luxation Saw & Accessories

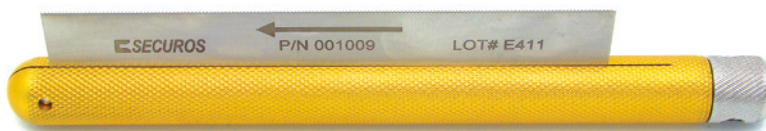

MWI#	SECUROS#	PRODUCT DESCRIPTION	THICKNESS (mm)	LENGTH (")
030965	001009	PLX Saw (Includes 25mm Blade)	-	7
030972	001010	15mm Replacement Blade for PLX Saw	0.3	5
030973	001011	25mm Replacement Blade for PLX Saw	0.3	5

The Patella Luxation Saw Reinvented!

The PLX Saw is an innovative solution to the shortcomings of the traditional patella luxation saw used for deepening the trochlear wedge during patella luxation repair. The PLX saw features an ergonomic design that is fully autoclavable and easy to assemble, clean, and manipulate. Additional benefits include:

- Innovative locking design eliminates the need for screws and wrench
- Saw blade remains perfectly straight
- Blades available in 15mm and 25mm sizes
- Anodized Aluminum saw handle and Stainless Steel saw blades made in the USA



Osteotomes

Pedfine Lambotte Osteotomes - Straight



MWI#	SECUROS#	WIDTH (mm)	LENGTH (")
042248	840254	4	5
045603	840255	6	5
045076	840257	8	5
045604	840259	10	5
045344	840260	12	5

Hoke Osteotomes - Straight



MWI#	SECUROS#	WIDTH (mm)	LENGTH (")
045277	840247	4	5.5
045074	840248	6	5.5
045366	840684	8	5.5
045084	840685	10	5.5
048271	840926	12	5.5

Mallets

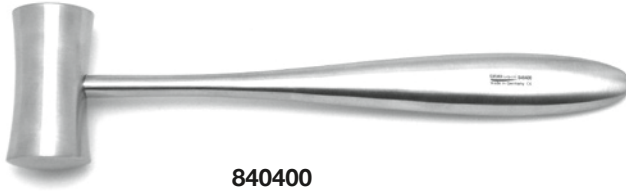

840400

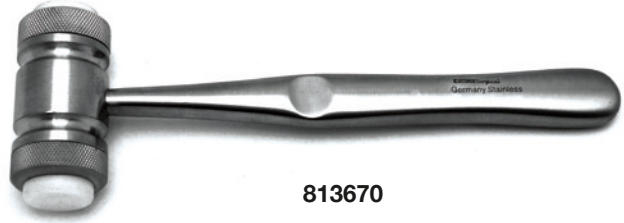

813670

MWI#	SECUROS#	PRODUCT DESCRIPTION	HEAD DIAMETER (")	WEIGHT (g)	LENGTH (")
048375	840400	Lucae Mallet	1	250	7.75
042163	813670	Mead Mallet (Includes Replacement Plastic Facings)	1	320	7.5
049220	840398	Replacement Plastic Facing for Mead Mallet - Pack of 2	-	-	-

Rasps



840358



840355



840357



840352



840356

Power Options



Looking for reciprocating rasps?
See page 165 for our offering
of Reciprocating Rasps.

MWI#	SECUROS#	PRODUCT DESCRIPTION	WIDTH (mm)	LENGTH (")
046143	840358	Trochlear Groove Rasp	8	7
090032	840355	Lewis Rasp	8	7
090069	840357	Cottle Rasp	8	8.25
036188	840352	Fomon Rasp & File	8	8.5
045523	840356	Aufricht Rasp	8.5	8

Rongeurs

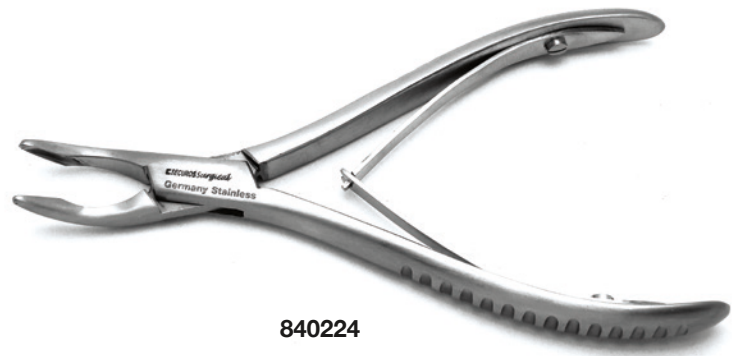
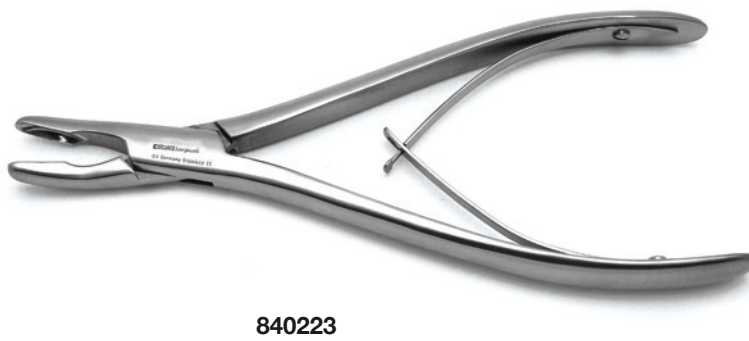

MWI#	SECUROS#	PRODUCT DESCRIPTION	FEATURE	LENGTH (")
044065	840221	Micro Friedman Rongeur	1.5x5mm Bite Curved	5.5
044055	840222	Lempert Rongeur	3x10mm Bite Straight	6.5
042162	810580	Lempert Rongeur	3x10mm Bite Curved	6.5
■ 370194	840223	Adson Rongeur	8x16mm Bite Straight	8
045273	840224	Dean Rongeur	3x11mm Bite Curved	5.75
044990	840227	Ruskin Rongeur	3x10mm Bite Curved	6
045073	840228	Ruskin Rongeur	4x15mm Bite Straight	7.25
045342	840229	Ruskin Rongeur	4x15mm Bite Curved	7.25

■ special order item

Bone Cutting Forceps



840218



840217

MWI#	SECUROS#	PRODUCT DESCRIPTION	FEATURE	LENGTH (")
■ 372092	003979	Molar Splitter	90 Degree Angle	6.5
090023	840218	Liston Bone Cutting Forceps	Angled on Flat	5.5
045272	840219	Liston Bone Cutting Forceps	Angled on Flat	7.5
049063	840220	Liston Bone Cutting Forceps	Angled on Flat	8.75
045341	840217	Ruskin-Liston Bone Cutting Forceps	Angled on Flat	7.5

Hand Chucks



MWI#	SECUROS#	PRODUCT DESCRIPTION	MAXIMUM PIN SIZE (")	LENGTH (")
029519	001480	Mini Dual Chuck Hand Chuck	5/32"	5.75



MWI#	SECUROS#	PRODUCT DESCRIPTION	MAXIMUM PIN SIZE (")	LENGTH (")
029517	001479	Dual Chuck Hand Chuck	1/4"	6.5



MWI#	SECUROS#	PRODUCT DESCRIPTION	LENGTH (")
047958	005015	Extension Handle Key for Dual Chuck Hand Chuck	5.5

■ special order item

Wire Benders



MWI#	SECUROS#	PRODUCT DESCRIPTION	FOR USE WITH
055140	840929	Universal K-wire Bender	.035"/.015"/.054"/.062" K-wires



MWI#	SECUROS#	PRODUCT DESCRIPTION	FOR USE WITH
390152	002062	Double K-wire Bender	0.054"/0.062" K-wires

Pin/Wire Cutters

Side Pin/Wire Cutters



MWI#	SECUROS#	FEATURE	MAXIMUM PIN SIZE (")	LENGTH (")
045293	840403	Single Action	5/64	5.75

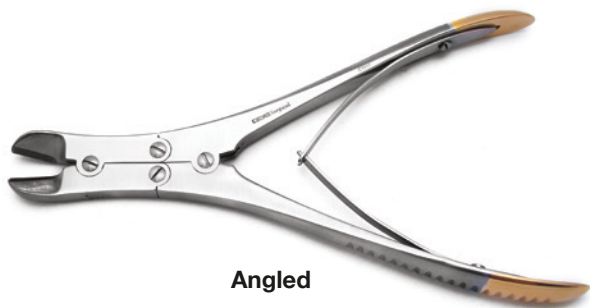

Angled

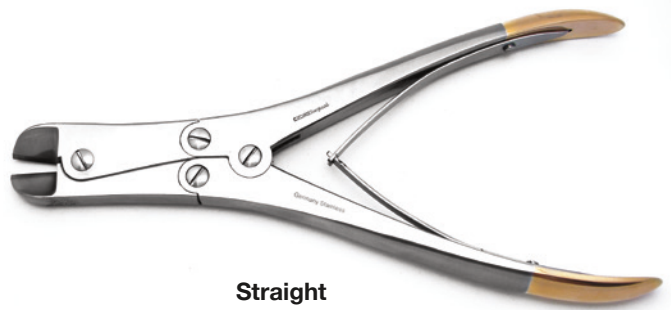

Straight

MWI#	SECUROS#	FEATURE	MAXIMUM PIN SIZE (")	LENGTH (")
042096	840406	Angled	5/64	7
045027	840404	Angled	3/32	8.75
035820	840405	Straight	3/32	9.25

Pin/Wire Cutters



MWI#	SECUROS#	FEATURE	MAXIMUM PIN SIZE (")	LENGTH (")
048638	840843	Side Pin Cutter TC "Hercules"	7/64	9.25

Front Pin/Wire Cutters



MWI#	SECUROS#	FEATURE	MAXIMUM PIN SIZE (")	LENGTH (")
048374	840927	Cannulated	0.062	7.5



MWI#	SECUROS#	FEATURE	MAXIMUM PIN SIZE (")	LENGTH (")
■ 276424	003759	Front Pin Cutter	1/8" (3.2mm)	10

STERILIZATION CONTAINERS

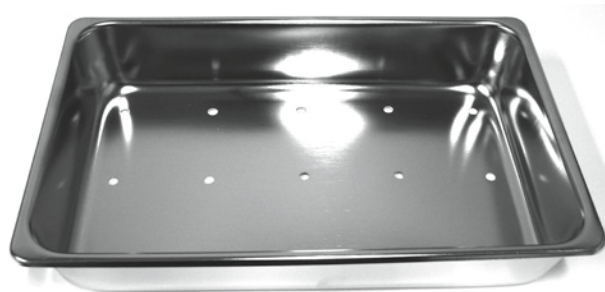

MWI#	SECUROS#	PRODUCT DESCRIPTION	LENGTH (")	WIDTH (")	HEIGHT (")
045220	001350	Perforated Tray	9	5	2

ACCOMMODATES					
Instruments					

■ special order item



Hip

Coxofemoral Luxation Management

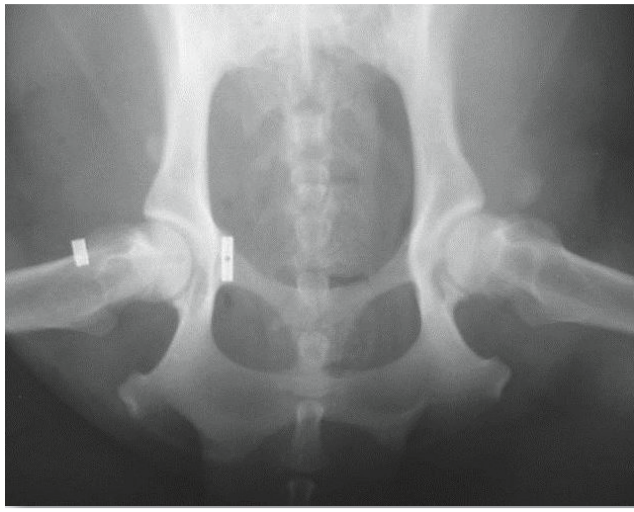

Radiographs provided by Veterinary Specialty Hospital - San Diego, CA

Dislocation of the hip joint results in displacement of the femoral head from the acetabulum, creating a disruption of the joint capsule and other local structures. Surgical reduction can be used to replace the hip and restore support structure when closed reduction is not successful.

SECUROS offers a variety of implants and instrumentation to provide additional mechanical support to the hip joint during the healing phase. The SECUROS Coxofemoral Luxation Management (CLM) System was originally developed over a 2-year period with leading universities prior to production.

Femoral Head Osteotomy

When restoration of the hip is not feasible due to injury or poor hip conformation, a Femoral Head Osteotomy (FHO) is one surgical option. FHOs require the removal of the femoral head and neck to produce a false joint. Proper patient selection is critical to the success of FHOs.

SECUROS features a comprehensive collection of instrumentation for FHOs including retractors, bone holding forceps, bone reduction forceps, osteotomes, mallets, bone cutting forceps, rasps, rongeurs, and power equipment.

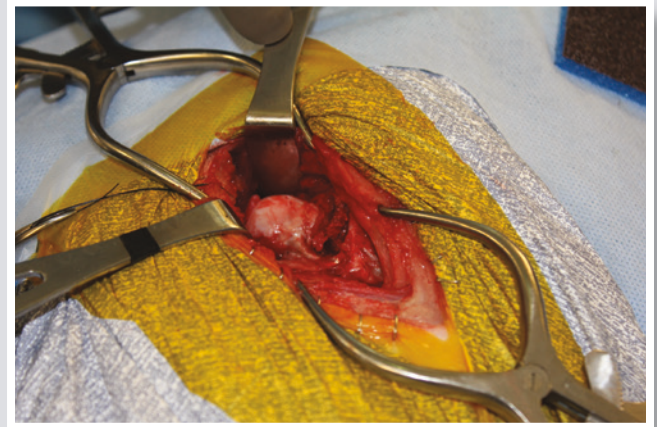

Pelvic Osteotomy

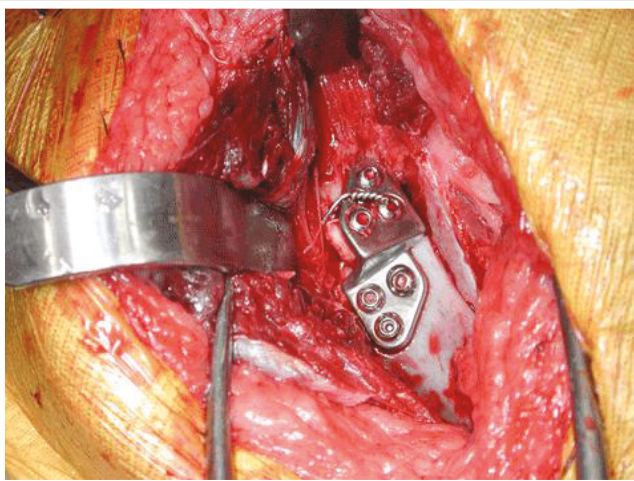

Canine Hip Dysplasia (CHD) typically results in hip joint instability or laxity. The long-term result to this joint laxity is progressive cartilage loss, scar tissue and/or osteophyte formation. Pelvic osteotomies are one surgical option for immature dogs with CHD. These procedures involve cutting the pelvis in two (DPO) or three (TPO) places and rotating the bone segments to increase the coverage of the femoral head by the acetabulum to decrease hip laxity.

SECUROS provides versatility to the surgeon by offering implants and instrumentation for both DPO and TPO procedures. Recently available are PAX locking DPO & TPO plates in varying angles.



SECUROS

Supreme Luxation Management

- Alternative to FHOs for **luxated hips**
- **Complete system** including: aiming guide, toggle rods, insertion device and suture puller
- Developed over **2 year** period with **leading** university
- **Fully compatible** with monofilament nylon or OrthoFiber suture



IMPLANTS

Toggle Rods

*Modified Piermattei Toggle

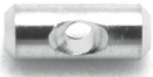

000600

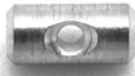

000650



001517



0002331



005490

MWI#	SECUROS#	DIAMETER (")	LENGTH (")	RECOMMENDED FOR TOGGLE ROD	
				SUTURE	DRILL BIT (mm)
042048	000600	5/64	0.2	60# Monofilament Nylon	2.4
042057	000650	3/32	0.2	60# Monofilament Nylon	2.4
035246	001517	1/8	0.5	100# Monofilament Nylon	3.2
035924	002331	5/32	0.75	100# Monofilament Nylon	4.5
■ 372183	005489	0.045	0.4	#5 OrthoFiber	3.2
■ 372184	005490	3/32	0.4	#5 OrthoFiber	4.5

Suture

Monofilament Nylon Suture Spools (100 Yard Length)



001198



001199



002073



001004



001106

MWI#	SECUROS#	PRODUCT DESCRIPTION	DIAMETER (")	RECOMMENDED DRILL BIT (mm)
029042	001198	20#	0.022	2.4
029043	001199	40#	0.032	2.4
029045	002073	60#	0.036	3.2
029046	001004	80#	0.045	3.2
029047	001106	100#	0.055	4.0

Single Strand OrthoFiber Braided Polyethylene (Non-absorbable) Suture (Box of 12, 36" Length, Sterile)

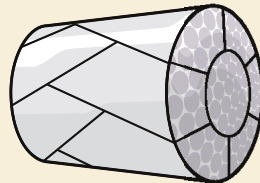

OrthoFiber is a braided sterile surgical suture prepared from ultra-high molecular weight, long-chain linear polyethylene (UHMWPE) fibers. Its unique, inter-locking core technology provides a sturdy core within the center of the suture to act as a backbone for enhanced handling characteristics. Additional benefits of OrthoFiber include:

- Improved strength and superior fixation characteristics over monofilament
- Superior abrasion resistance when compared to polyester
- Excellent biocompatibility as measured and tested according to ISO 10993
- Available in a variety of pre-sterile suture pack configurations

MWI#	SECUROS#	PRODUCT DESCRIPTION	DIAMETER (")	RECOMMENDED DRILL BIT (mm)
055171	005506	#2 OrthoFiber Suture without Needles	0.020	2.4
031032	001104	#5 OrthoFiber Suture without Needles	0.027	2.4

■ special order item

INSTRUMENTS

Instruments for Coxofemoral Luxation Management



MWI#	SECUROS#	PRODUCT DESCRIPTION
035930	001513	Universal Aiming Device (Includes 3.2mm Drill Sleeve)



MWI#	SECUROS#	PRODUCT DESCRIPTION	LENGTH (")
035972	001515	Monofilament Nylon Puller	8.5

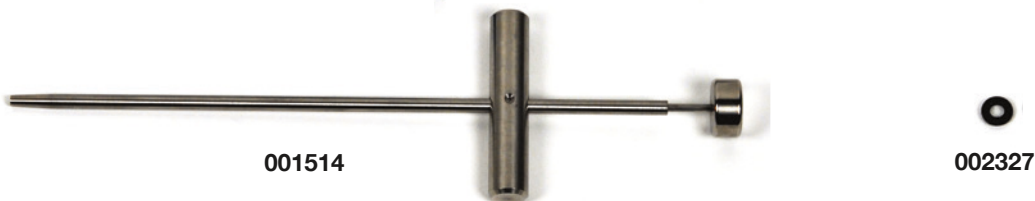

MWI#	SECUROS#	DIAMETER (")	LENGTH (")
036053	001514	Toggle Rod Insertion Device	9
042268	002327	O-Ring for Toggle Rod Insertion Device	-
036052	001516	O-Ring for Toggle Rod Insertion Device - Pack of 6	-

Femoral Ligament Cutters (Hatt Spoons)



MWI#	SECUROS#	FEATURE	LENGTH (")
■ 372093	840865	10x17mm Cup	9
045022	840375	15x23mm Cup	9
■ 372094	840866	20x34mm Cup	9

■ special order item

Retractors

Meyering Retractors



MWI#	SECUROS#	WIDTH (mm)	BLADE LENGTH (mm)	LENGTH (")
045266	840210	16	52	9
044989	840211	25	75	9
049062	840212	50	89	9

Army Retractor (Set of 2)



MWI#	SECUROS#	WIDTH (mm)	LENGTH (")
045262	840193	16	8.5

Aufranc Cobra Retractor



MWI#	SECUROS#	LENGTH (")
090016	802013	11

Hohmann Retractor



MWI#	SECUROS#	WIDTH (mm)	LENGTH (")
■ 372166	840949	25	10.5

■ special order item

Retractors

Gelpi Retractors

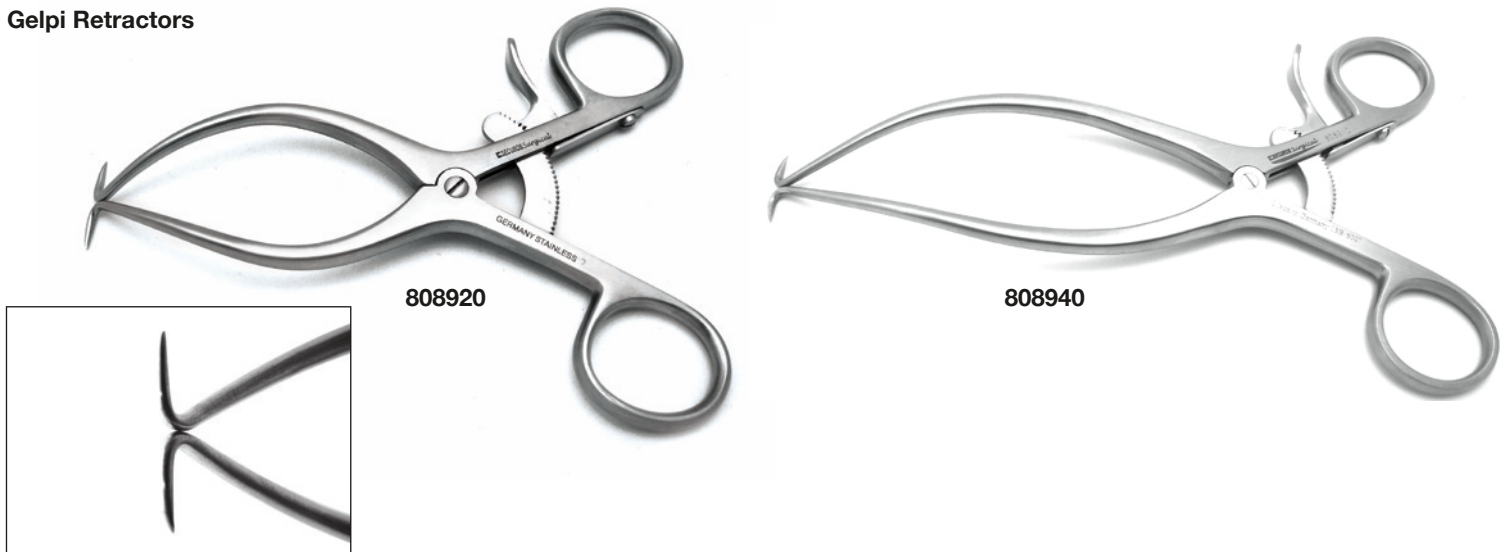

MWI#	SECUROS#	LENGTH (")
035922	840178	3.5
036190	840179	4.5
055012	808920	5.5
039505	808940	7.5

Drill Bits

Jacobs Chuck Coupling (BITE Bit, Titanium Nitride Coated)



MWI#	SECUROS#	DIAMETER (mm)	TOTAL LENGTH (mm)	FLUTE LENGTH (mm)
031129	001358	2.4	143	32
028992	001357	3.2	166	32
031130	001360	4.0	166	32

Quick Coupling (BITE Bit, Titanium Nitride Coated)



MWI#	SECUROS#	DIAMETER (mm)	TOTAL LENGTH (mm)	FLUTE LENGTH (mm)
042090	001361	2.4	140	32
045544	001362	3.2	166	32
045559	000644	4.0	166	32

STERILIZATION CONTAINERS

Sterilization Trays

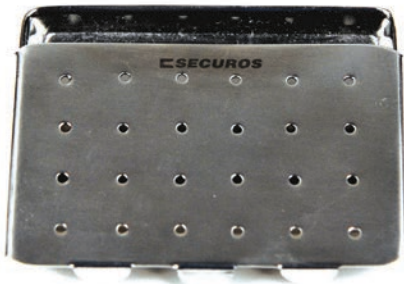

001003

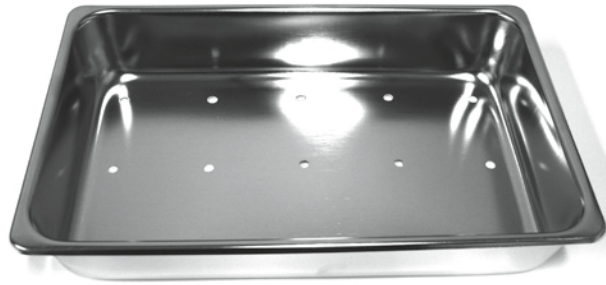

001350

MWI#	SECUROS#	PRODUCT DESCRIPTION	LENGTH (")	WIDTH (")	HEIGHT (")
029096	001003	Preforated Tray	2.7	2	0.4

ACCOMMODATES

Toggle Rods, Crimp Clamps

MWI#	SECUROS#	PRODUCT DESCRIPTION	LENGTH (")	WIDTH (")	HEIGHT (")
045520	001350	Preforated Tray	9	5	2

ACCOMMODATES

Instruments

Organizer Bags



MWI#	SECUROS#	PRODUCT DESCRIPTION
031193	001512	Coxofemoral Luxation Organizer Bag

ACCOMMODATES

Universal Aiming Device, Monofilament Nylon Puller, Toggle Rod Insertion Device, Drill Bits (2), Small Sterilization Tray (1)

REFERENCE MATERIALS



MWI#	SECUROS#	PRODUCT DESCRIPTION
■ 372165	005492	Coxofemoral Luxation Bone Model

■ special order item



SECUROS Femoral Head Osteotomy

Complete line of instruments to accommodate surgeon preference for Femoral Head Osteotomy including:

- Various sizes of **Hatt Spoons** for femoral ligament removal
- Variety of **osteotomes, bone cutting forceps** and sagittal/oscillating power **saw blades** for proper osteotomies
- Mallets, rasps and bone holding forceps

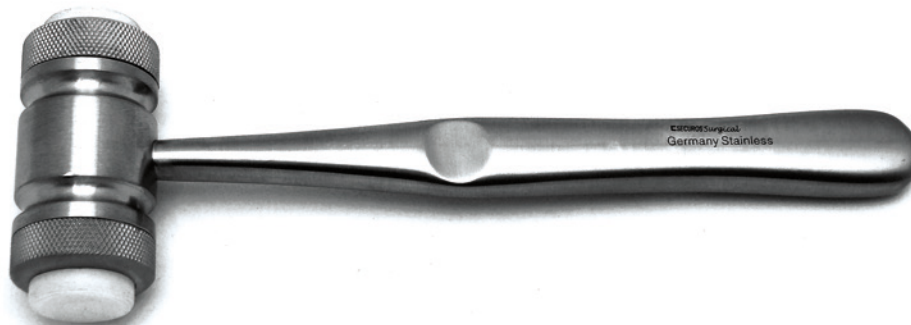

INSTRUMENTS

Femoral Ligament Cutters (Hatt Spoons)



MWI#	SECUROS#	FEATURE	LENGTH (")
■ 372093	840865	10 x 17mm Cup	9
045022	840375	15 x 23mm Cup	9
■ 372094	840866	20 x 34mm Cup	9

Retractors

Meyering Retractor



MWI#	SECUROS#	WIDTH (mm)	BLADE LENGTH (mm)	LENGTH (")
045266	840210	16	52	9
044989	840211	25	75	9
049062	840212	50	89	9

Army Retractor (Set of 2)



MWI#	SECUROS#	WIDTH (mm)	LENGTH (")
045262	840193	16	8.5

Aufranc Cobra Retractor



MWI#	SECUROS#	LENGTH (")
090016	802013	11

Hohmann Retractor



MWI#	SECUROS#	WIDTH (mm)	LENGTH (")
■ 372166	840949	25	10.5

■ special order item

Bone Holding Forceps

Kern Bone Clamps



MWI#	SECUROS#	FEATURE	LENGTH (")
044998	840319	Ratchet	4.5
044999	840321	Ratchet	5.75
045236	816290	Ratchet	8.5
045285	840320	Ratchet	9.5
■ 279525	816411	Without Ratchet	5.75
045019	840322	Without Ratchet	8.5

Clamshell Bone Reduction Forceps



MWI#	SECUROS#	FEATURE	LENGTH (")
049184	840334	Ratchet	5.5
090028	840335	Ratchet	6
045346	840328	Speedlock	6
043916	840329	Speedlock	7
045020	840330	Speedlock	8
■ 370195	840331	Speedlock	9
049653	840332	Speedlock	10.25
049654	840333	Speedlock	11

■ special order item

Osteotomes

Pedifine Lambotte Osteotomes - Straight



MWI#	SECUROS#	WIDTH (mm)	LENGTH (")
042248	840254	4	5
045603	840255	6	5
045076	840257	8	5
045604	840259	10	5
045344	840260	12	5

Hoke Osteotomes - Straight



MWI#	SECUROS#	WIDTH (mm)	LENGTH (")
045277	840247	4	5.5
045074	840248	6	5.5
045366	840684	8	5.5
045084	840685	10	5.5
048271	840926	12	5.5

Mallets



840400



813670

MWI#	SECUROS#	PRODUCT DESCRIPTION	HEAD DIAMETER (")	WEIGHT (g)	LENGTH (")
048375	840400	Lucae Mallet	1	250	7.5
042163	813670	Mead Mallet (Includes Replacement Plastic Facings)	1	320	7.5
049220	840398	Replacement Plastic Facings - Pack of 2	-	-	-

Bone Cutting Forceps



MWI#	SECUROS#	PRODUCT DESCRIPTION	TYPE	LENGTH (")
■ 372092	003979	Molar Splitter	90 Degree Angle	6.5
090023	840218	Liston Bone Cutting Forceps	Angled on Flat	5.5
045272	840219	Liston Bone Cutting Forceps	Angled on Flat	7.5
049063	840220	Liston Bone Cutting Forceps	Angled on Flat	8.75
045341	840217	Ruskin-Liston Cutting Forceps	Angled on Flat	7.5

Rasps



MWI#	SECUROS#	PRODUCT DESCRIPTION	WIDTH (mm)	LENGTH (")
036188	840352	Fomon Rasp	8	8.5
046143	840358	Trochlear Groove Rasp	8	7
090032	840355	Lewis Rasp	8	7
090069	840357	Cottle Rasp	8	8.25
045523	840356	Aufricht Rasp	8.5	8
045347	840353	Putti Bone Rasp - Double Ended Flat Blades	18	10.5
049208	840354	Putti Bone Rasp - Double Ended Round & Flat Blades	10, 15	12

■ special order item

Rongeurs



840221



840222



840223



840224



840228

MWI#	SECUROS#	PRODUCT DESCRIPTION	FEATURE	LENGTH (")
044065	840221	Micro Friedman Rongeur	1.5x5mm Bite Curved	5.5
044055	840222	Lempert Rongeur	3x10mm Bite Straight	6.5
042162	810580	Lempert Rongeur	3x10mm Bite Curved	6.5
■ 370194	840223	Adson Rongeur	8x16mm Bite Straight	8
045273	840224	Dean Rongeur	3x11mm Bite Curved	5.75
044990	840227	Ruskin Rongeur	3x10mm Bite Curved	6
045073	840228	Ruskin Rongeur	4x15mm Bite Straight	7.25
045342	840229	Ruskin Rongeur	4x15mm Bite Curved	7.25



Power Options

Looking for sagittal/oscillating saw blades? Go to page 305 for our offering of saw blades.

■ special order item



Options for Pelvic Osteotomies

- **TPO** plates available in 3.5mm **PAX Locking** (titanium) and non-locking (stainless steel) styles
- DPO plates available in 3.5mm PAX Locking (titanium) style
- **Sagittal/reciprocating** saw blades for osteotomy cuts
- Complete **instrument** line to assist with TPO/DPO procedures

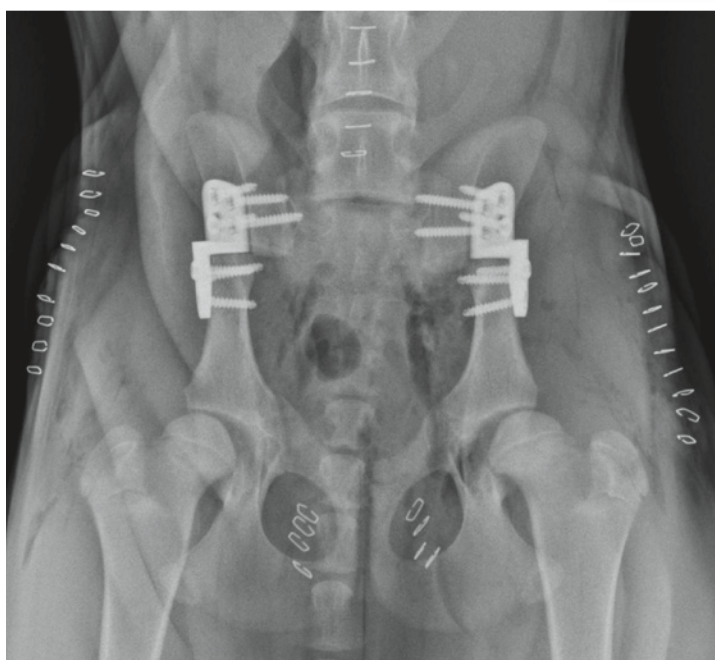

* Radiograph provided by Matthew Barnhart, DVM, MS, DACVS, MedVet Ohio

IMPLANTS

Triple Pelvic Osteotomy Plates

3.5mm Conventional TPO Plates - Stainless Steel (6 holes)



000360

000361

MWI#	SECUROS#	DEGREE ROTATION	DIRECTION
044670	000360	20	Left
045546	000361	20	Right
036185	000358	30	Left
036186	000359	30	Right
055052	004009	40	Left
045182	004010	40	Right

3.5mm PAX Locking TPO Plates - Titanium (Gold, 6 Holes)



007112

007113

MWI #	SECUROS#	DEGREE ROTATION	DIRECTION
044660	007108	20	Left
044661	007109	20	Right
045207	007110	25	Left
045208	007111	25	Right
044662	007112	30	Left
044663	007113	30	Right
045063	007114	40	Left
045209	007115	40	Right

Double Pelvic Osteotomy Plates

3.5mm PAX Locking DPO Plates - Titanium (Gold, 7 holes)



007135

007136

MWI#	SECUROS#	DEGREE ROTATION	DIRECTION
049108	007135	20	Left
049109	007136	20	Right
045570	007139	30	Left
055059	007140	30	Right
049122	007141	40	Left
049123	007142	40	Right

3.5mm PAX Locking DPO Plates - Titanium (Gold, 8 holes)



007146

007147

MWI#	SECUROS#	DEGREE ROTATION	DIRECTION
090009	007146	30	Left
090010	007147	30	Right

3.5mm Cortical Screws

3.5mm Cortical Screw, Self-Tapping, Hexagonal Recess - Stainless Steel



Diameter of Thread: 3.5mm

Diameter of Head: 6.0mm

Drill Bit for Threaded Hole: 2.5mm

For Use with 2.7/3.5/4.0mm Hexagonal Screwdriver

MWI#	SECUROS#	LENGTH (mm)
029200	001885	10
029201	001886	12
029202	001887	14
029203	001888	16
029204	001889	18
029205	001890	20
029207	001891	22
029208	001892	24

MWI#	SECUROS#	LENGTH (mm)
029209	001893	26
029210	001894	28
029211	001895	30
029212	001896	32
029213	001897	34
029214	001898	36
029215	001899	38
029216	002101	40

3.5mm Cortical Screw, Self-Tapping, Hexagonal Recess - Titanium (Gold)



Diameter of Thread: 3.5mm

Diameter of Head: 6.0mm

Drill Bit for Threaded Hole: 2.5mm

For Use with 2.7/3.5/4.0mm Hexagonal Screwdriver

MWI#	SECUROS#	LENGTH (mm)
042080	001075	10
031070	001076	12
031071	001077	14
031072	001078	16
031073	001079	18
031074	001080	20
031075	001081	22
031076	001082	24

MWI#	SECUROS#	LENGTH (mm)
031077	001083	26
031078	001084	28
031079	001085	30
042082	001086	32
042083	001087	34
042084	001088	36
042085	001089	38
042086	001090	40

3.5mm Cortical Screws

3.5mm PAX Locking Screw, Self-Tapping, Star Recess - Titanium (Gold)



Diameter of Thread: 3.5mm

Diameter of Head: 5.0mm

Drill Bit For Threaded Hole: 2.5mm

For Use with T15 Stardrive Screwdriver

MWI#	SECUROS#	LENGTH (mm)
042356	007081	8
042357	007082	10
042359	007083	12
042361	007084	14
042364	007085	16
042366	007086	18
042368	007087	20
042369	007088	22
044659	007089	24

MWI#	SECUROS#	LENGTH (mm)
042100	007090	26
042105	007091	28
042106	007092	30
042107	007093	32
042108	007094	34
042109	007095	36
042111	007096	38
042112	007097	40

INSTRUMENTS

Drill Bits

Jacobs Chuck Coupling (BITE Bit, Titanium Nitride Coated)



MWI#	SECUROS#	DIAMETER (mm)	TOTAL LENGTH (mm)	FLUTE LENGTH (mm)	RECOMMENDED SCREWS (mm)
028996	002037	2.5	96	50	3.5

Quick Coupling (BITE Bit, Titanium Nitride Coated)



MWI#	SECUROS#	DIAMETER (mm)	TOTAL LENGTH (mm)	FLUTE LENGTH (mm)	RECOMMENDED SCREWS (mm)
029011	001019	2.5	110	32	3.5

Drill Guides

Double Drill Guides



MWI#	SECUROS#	PRODUCT DESCRIPTION
030970	002067	1.5/2.0mm Double Drill Guide
031195	001022	2.0/2.7mm Double Drill Guide
030996	001023	2.5/3.5mm Double Drill Guide

Compressional Drill Guides



MWI#	SECUROS#	PRODUCT DESCRIPTION
029018	001904	3.5mm Compressional Drill Guide

Drill Guides

Universal Drill Guides



MWI#	SECUROS#	PRODUCT DESCRIPTION
042267	002279	3.5mm Universal Drill Guide

PAX Drill Guide



MWI#	SECUROS#	PRODUCT DESCRIPTION
051989	007178	3.5mm PAX Neutral/Load (Compressional) Drill Guide

Depth Gauges

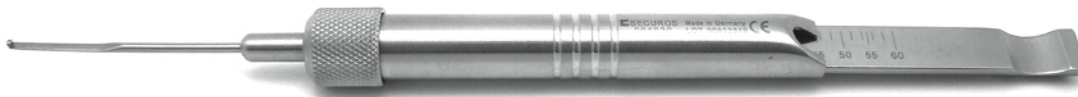

MWI#	SECUROS#	PRODUCT DESCRIPTION	MEASURES UP TO (mm)	MEASUREMENT INCREMENTS (mm)
029098	001020	2.7/3.5/4.0mm Depth Gauge	60	2 & 5
090001	005329	2.7/3.5/4.0mm Depth Gauge	60	1



MWI#	SECUROS#	PRODUCT DESCRIPTION	MEASURES UP TO (mm)	MEASUREMENT INCREMENTS (mm)
042355	007066	2.7/3.5mm PAX Depth Gauge	80	1

Screwdrivers, Handles & Shafts

Screwdriver (Includes holding sleeve)

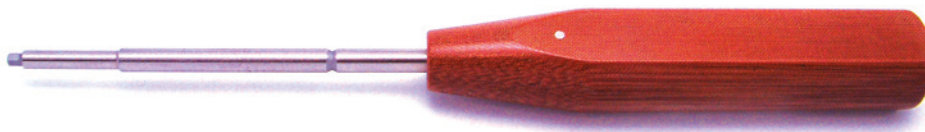

MWI#	SECUROS#	PRODUCT DESCRIPTION	LENGTH (")
029524	001024	2.7/3.5/4.0mm Hexagonal Screwdriver	7.75

Screwdrivers, Handles & Shafts

Screwdriver Shafts (Quick Coupling, Includes Holding Sleeve)

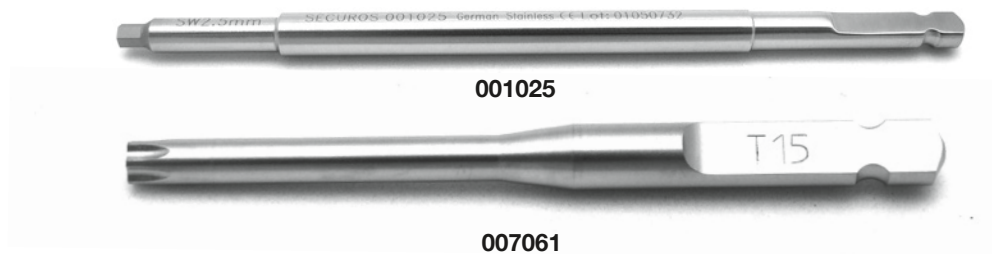

MWI#	SECUROS#	PRODUCT DESCRIPTION	FOR USE WITH	LENGTH (")
029525	001025	2.7/3.5/4.0mm Hexagonal Screwdriver Shaft	Small, Large, Silicone QC Handle	4
042353	007061	2.7/3.5mm Stardrive Screwdriver Shaft (T15)	Small, Large, Silicone QC Handle	2.25

Screwdriver Handles (Quick Coupling)



MWI#	SECUROS#	PRODUCT DESCRIPTION	ACCOMMODATES	LENGTH (")
029529	007003	Small Handle	2.7/3.5/4.0mm and T15 Shafts	4.5



MWI#	SECUROS#	PRODUCT DESCRIPTION	ACCOMMODATES	LENGTH (")
029528	001916	Large Handle	2.7/3.5/4.0mm and T15 Shafts	6



MWI#	SECUROS#	PRODUCT DESCRIPTION	ACCOMMODATES	LENGTH (")
052748	007180	Silicone Handle	2.7/3.5/4.0mm and T15 Shafts	5.5

Screwdriver Holding Sleeves



MWI#	SECUROS#	PRODUCT DESCRIPTION
043904	002190	2.7/3.5/4.0mm Standard Hexagonal Screwdriver Holding Sleeve

Retractors

Meyering Retractors



MWI#	SECUROS#	WIDTH (mm)	BLADE LENGTH (mm)	LENGTH (")
045266	840210	16	52	9
044989	840211	25	75	9
049062	840212	50	89	9

Army Retractor (Set of 2)



MWI#	SECUROS#	WIDTH (mm)	LENGTH (")
045262	840193	16	8.5

Aufranc Cobra Retractor



MWI#	SECUROS#	LENGTH (")
090016	802013	11

Hohmann Retractor



MWI#	SECUROS#	WIDTH (mm)	LENGTH (")
■ 372166	840949	25	10.5

Volkman Bone Hook



MWI#	SECUROS#	LENGTH (")
■ 372095	807780	8.75

■ special order item

Bone Holding Forceps

Kern Bone Clamps



840321

MWI#	SECUROS#	FEATURE	LENGTH (")
044998	840319	Ratchet	4.5
044999	840321	Ratchet	5.75
045236	816290	Ratchet	8.5
045285	840320	Ratchet	9.5

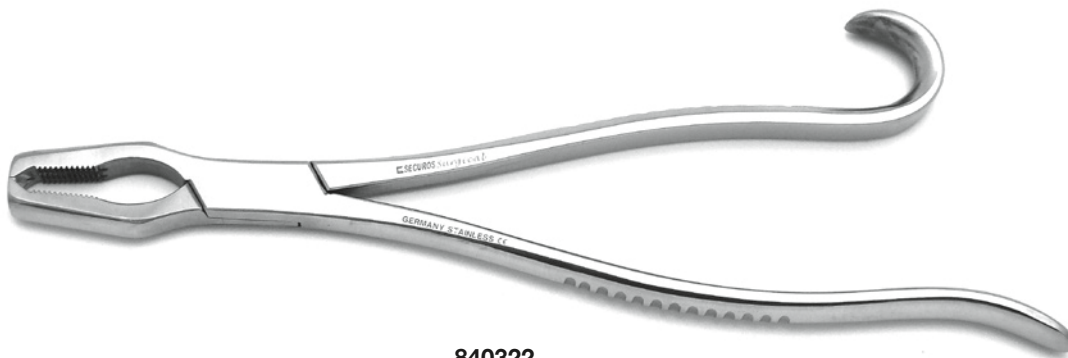

840322

MWI#	SECUROS#	FEATURE	LENGTH (")
■ 279525	816411	Without Ratchet	5.75
045019	840322	Without Ratchet	8.5

■ special order item

Bone Holding Forceps

Clamshell Bone Reduction Forceps



MWI#	SECUROS#	FEATURE	LENGTH (")
045346	840328	Speedlock	6
043916	840329	Speedlock	7
045020	840330	Speedlock	8
■ 370195	840331	Speedlock	9
049653	840332	Speedlock	10.25
049654	840333	Speedlock	11

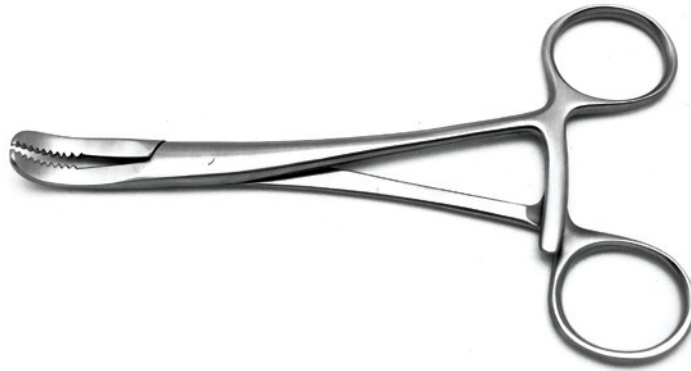

MWI#	SECUROS#	FEATURE	LENGTH (")
049184	840334	Ratchet	5.5
090028	840335	Ratchet	6

Sterilization Containers

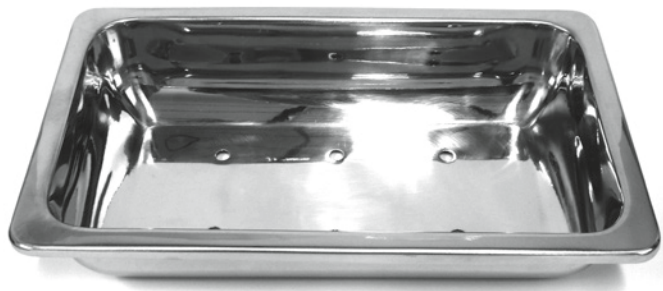

MWI#	SECUROS#	PRODUCT DESCRIPTION	LENGTH (")	WIDTH (")	HEIGHT (")
045520	001350	Perforated Tray	9	5	2
ACCOMMODATES					
Instruments					

■ special order item

Carpus & Tarsus



Arthrodesis Clinical Cases

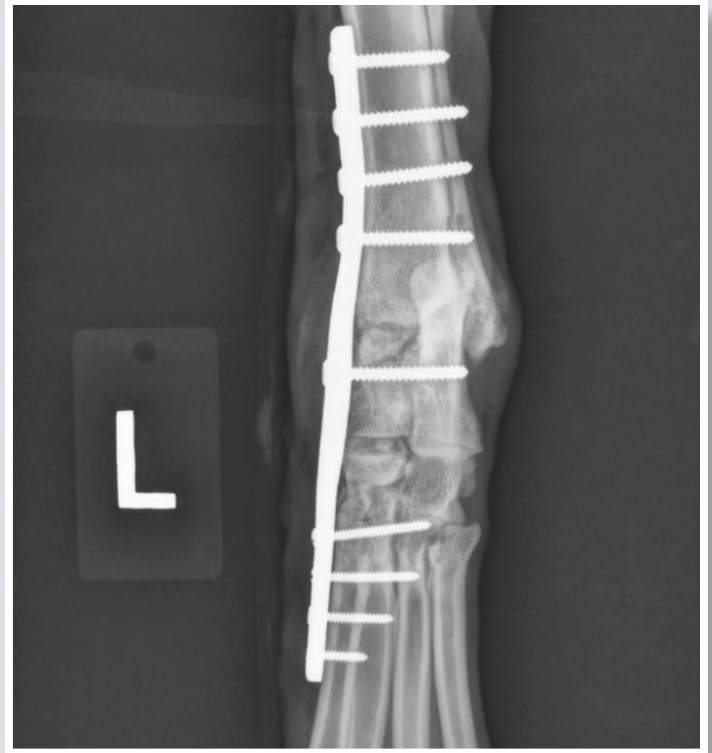
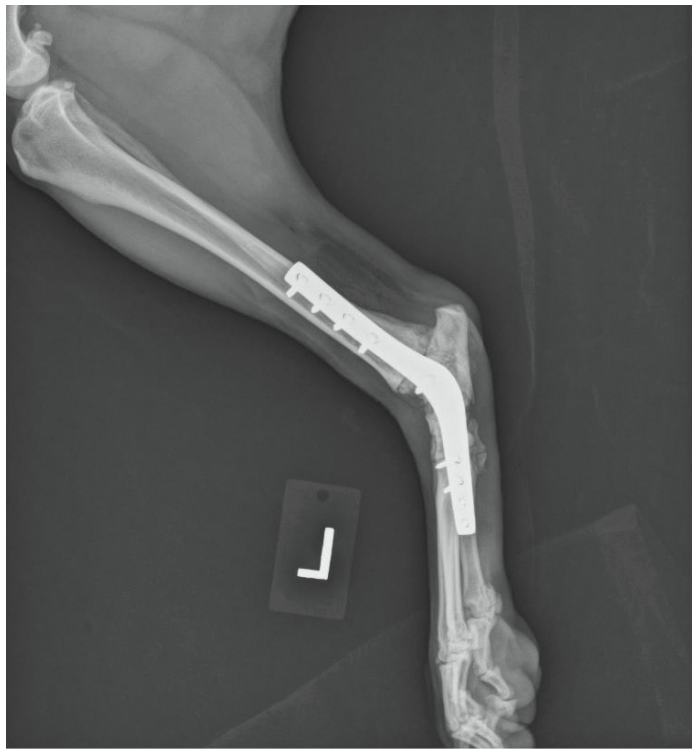

* Radiographs provided by Veterinary Specialty Hospital, San Diego , CA



IMPLANTS

Pancarpal Arthrodesis Plates - Stainless Steel



Round



Compression

MWI#	SECUIROS#	DISTAL/PROXIMAL HOLE SIZE (mm)	# OF HOLES	LENGTH (mm)	HOLE TYPE
042225	001824	1.5/2.0	9	53	Compression
029111	001825	2.0/2.0	9	57	Compression
029112	001826	2.0/2.7	9	75.5	Round
042226	001827	2.0/2.7	9	75.5	Compression
029116	001830	2.7/3.5	9	102	Round
029117	001831	2.7/3.5	9	102	Compression
046125	001828	2.7/3.5 - Long	9	119	Round
042227	001829	2.7/3.5 - Long	9	119	Compression
048537	001833	3.5/3.5	10	140	Round
029120	001834	3.5/3.5	10	140	Compression
046126	001832	3.5/3.5 - Long	11	152	Compression

Pantarsal Arthrodesis Plates - Stainless Steel



MWI#	SECUROS#	DISTAL/PROXIMAL HOLE SIZE (mm)	APPLICATION	# OF HOLES	OVERALL SPAN (mm)	ANGLE
044618	003528	2.7/2.0	Left Medial/Right Lateral	9	74.5	120°
055046	003527	2.7/2.0	Right Medial/Left Lateral	9	74.5	120°
044619	000601	2.7/2.0	Left Medial/Right Lateral	9	106	137°
044620	000602	2.7/2.0	Right Medial/Left Lateral	9	106	137°
044621	000603	3.5/2.7	Left Medial/Right Lateral	9	146	136°
042051	000604	3.5/2.7	Right Medial/Left Lateral	9	146	136°

1.5mm Cortical Screws

1.5mm Cortical Screw, Self-Tapping, Cruciform Recess - Stainless Steel



Diameter of Thread: 1.5mm

Diameter of Head: 3.0mm

Drill Bit for Threaded Hole: 1.1mm

For Use with 1.5/2.0mm Cruciform Screwdriver

MWI#	SECUROS#	LENGTH (mm)
042141	100026	6
042125	100000	7
042126	100001	8
042127	100002	9
042128	100003	10
042142	100027	11
042129	100004	12
049131	100028	13
042130	100005	14
042131	100006	16
044000	100007	18
044001	100008	20

1.5mm Cortical Screw, Self-Tapping, Hexagonal Recess - Stainless Steel



Diameter of Thread: 1.5mm

Diameter of Head: 3.0mm

Drill Bit for Threaded Hole: 1.1mm

For Use with 1.5/2.0mm Hexagonal Screwdriver

MWI#	SECUROS#	LENGTH (mm)
029121	001835	6
029122	001836	7
029123	001837	8
029124	001839	9
029125	001840	10
031110	002529	11
029126	001841	12
031111	002530	13
029127	001842	14
029128	001843	16
031112	001844	18
031113	001845	20

2.0mm Cortical Screws

2.0mm Cortical Screw, Self-Tapping, Cruciform Recess - Stainless Steel



Diameter of Thread: 2.0mm

Diameter of Head: 4.0mm

Drill Bit for Threaded Hole: 1.5mm

For Use with 1.5/2.0mm Cruciform Screwdriver

MWI#	SECUROS#	LENGTH (mm)
042132	100009	6
042133	100010	8
042134	100011	10
042140	100022	12
■ 370036	100048	13
042135	100012	14
042136	100013	16
042137	100014	18
042138	100016	20

2.0mm Cortical Screw, Self-Tapping, Hexagonal Recess - Stainless Steel



Diameter of Thread: 2.0mm

Diameter of Head: 4.0mm

Drill Bit for Threaded Hole: 1.5mm

For Use with 1.5/2.0mm Hexagonal Screwdriver

MWI#	SECUROS#	LENGTH (mm)
029135	001853	6
029136	001854	8
029137	001855	10
029138	001856	12
■ 370039	005123	13
029139	001857	14
029140	001858	16
029141	001859	18
029142	001860	20



■ special order item

2.7mm Cortical Screws

2.7mm Cortical Screw, Self-Tapping, Hexagonal Recess - Stainless Steel



Diameter of Thread: 2.7mm

Diameter of Head: 5.0mm

Drill Bit for Threaded Hole: 2.0mm

For Use with 2.7/3.5/4.0mm Hexagonal

Screwdriver

MWI#	SECUROS#	LENGTH (mm)	MWI#	SECUROS#	LENGTH (mm)
031116	002540	6	029174	001632	24
029166	001878	8	029175	001633	26
029167	001879	10	029176	001634	28
029168	001880	12	029177	001635	30
029169	001881	14	029178	001636	32
029170	001882	16	031117	002549	34
029171	001883	18	031152	002550	36
029172	001630	20	035974	003554	38
029173	001631	22	042294	002551	40

3.5mm Cortical Screws

3.5mm Cortical Screw, Self-Tapping, Hexagonal Recess - Stainless Steel



Diameter of Thread: 3.5mm

Diameter of Head: 6.0mm

Drill Bit for Threaded Hole: 2.5mm

For Use with 2.7/3.5/4.0mm Hexagonal

Screwdriver

MWI#	SECUROS#	LENGTH (mm)	MWI#	SECUROS#	LENGTH (mm)
029200	001885	10	029209	001893	26
029201	001886	12	029210	001894	28
029202	001887	14	029211	001895	30
029203	001888	16	029212	001896	32
029204	001889	18	029213	001897	34
029205	001890	20	029214	001898	36
029207	001891	22	029215	001899	38
029208	001892	24	029216	002101	40

Velocity Bioactive Synthetic Bone Graft (Sterile)



Particulate



Putty

MWI#	SECUROS#	PRODUCT DESCRIPTION	VOLUME PER BOX
032390	000841	Particulate	Two - 2.5cc
042333	003623	Putty	1.0cc
035245	003756	Putty	2.5cc
032391	000842	Putty	5.0cc

Velocity Bioactive Synthetic Bone Graft is comprised of 100% synthetic bioactive materials that are composed from elements that naturally occur in the body. The carrier is rapidly removed from the site through enzymatic activity leaving behind a bioactive material capable of regenerating new bone from existing bone. Both the Velocity Putty and Particulate are osteostimulative; defined as the active stimulation of osteoblast proliferation and differentiation due to ionic dissolution products released from Velocity during absorption.

INSTRUMENTS Screw & Plate Forceps

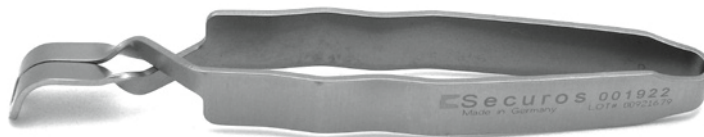

MWI#	SECURO #	PRODUCT DESCRIPTION	LENGTH (")
042243	001922	Self-Holding Screw Forceps	3.5



MWI#	SECURO #	PRODUCT DESCRIPTION	LENGTH (")
043946	001923	Plate Holding Forceps	4.5

INSTRUMENTS

Bone Reduction Forceps



MWI#	SECUROS#	FEATURE	LENGTH (")
035878	840345	Ratchet, Curved, Pointed Tips	5.5



MWI#	SECUROS#	FEATURE	LENGTH (")
045001	840346	Ratchet, Curved, Pointed Tips	8.5

Retractors

SENN Retractor

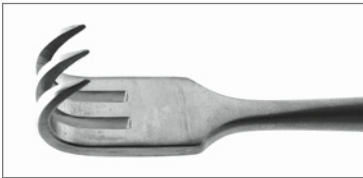

MWI#	SECUROS#	FEATURE	LENGTH (")
030961	815750	3 Prong, Sharp	6.25

Gelpi Retractor

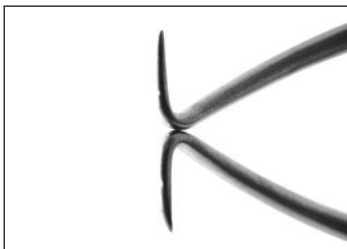

MWI#	SECUROS#	LENGTH (")
035922	840178	3.5
036190	840179	4.5

Burs

MicroAire® Medium-Length Burs (Carbide)

*Use with Medium Bur Guard, Also fits Linvatec® Micro Drills



Round-Cut

MWI#	SECUROS#	HEAD DIAMETER (mm)	HEAD LENGTH (mm)	# OF FLUTES	OVERALL LENGTH (mm)
043931	002923	1	1	6	50.8
043799	002924	1.5	1.5	6	50.8
043902	002925	2	2	6	50.8
043928	002926	2.4	2.4	6	50.8
042310	002927	3	3	8	50.8
043930	002928	4	4	8	48.3
045506	002929	5	5	10	48.3
048144	002933	6.5	6.5	10	48.3



Oval-Cut

MWI#	SECUROS#	HEAD DIAMETER (mm)	HEAD LENGTH (mm)	# OF FLUTES	OVERALL LENGTH (mm)
043912	002941	4	7.9	8	47.8

MicroAire® Long Burs (Carbide)

*Use with Long Bur Guard, Also fits Linvatec® Micro Drills



Round-Cut

MWI#	SECUROS#	HEAD DIAMETER (mm)	HEAD LENGTH (mm)	# OF FLUTES	OVERALL LENGTH (mm)
043900	002934	1	1	6	73.2
048145	002935	1.5	1.5	6	73.2
043929	002936	2	2	6	73.2
042311	002937	3	3	8	73.2
042312	002938	4	4	8	69.9
042313	002939	5	5	10	69.9
055020	002940	6.5	6.5	10	69.9



Oval-Cut

MWI#	SECUROS#	HEAD DIAMETER (mm)	HEAD LENGTH (mm)	# OF FLUTES	OVERALL LENGTH (mm)
043927	002942	4	7.9	8	69.9
045517	000609	5.5	9.9	10	69.9

Oral Surgery Burs (Carbide)

For use with Stryker® Roto Osteotome® and Micro Drills



MWI#	SECUROS#	HEAD DIAMETER (mm)	HEAD LENGTH (mm)	# OF FLUTES	OVERALL LENGTH (mm)
045627	003263	2.3	2.3	6	44.5
045626	003262	3.1			48
044050	003264	4			51

Rasps

For use with MicroAire® Reciprocating Saw



MWI#	SECUROS#	PRODUCT DESCRIPTION	WIDTH (mm)	USABLE LENGTH (mm)
388096	005450	Cross-Serrated	5.3	11



MWI#	SECUROS#	PRODUCT DESCRIPTION	WIDTH (mm)	USABLE LENGTH (mm)
388097	005451	Small Cross-Cut	5.5	9.5



MWI#	SECUROS#	PRODUCT DESCRIPTION	WIDTH (mm)	USABLE LENGTH (mm)
388098	005452	Large Cross-Cut	6.5	1.5

Drill Bits

Jacobs Chuck Coupling (BITE Bit, Titanium Nitride Coated)



MWI#	SECUROS#	DIAMETER (mm)	TOTAL LENGTH (mm)	FLUTE LENGTH (mm)	RECOMMENDED SCREWS (mm)
028993	002034	1.1	46	18	1.5
028994	002035	1.5	70	23	2.0
028995	002036	2.0	86	50	2.7
028996	002037	2.5	96	50	3.5

Quick Coupling (BITE Bit, Titanium Nitride Coated)



MWI#	SECUROS#	DIAMETER (mm)	TOTAL LENGTH (mm)	FLUTE LENGTH (mm)	RECOMMENDED SCREWS (mm)
029008	002043	1.1	60	15	1.5
029009	002044	1.5	85	18	2.0
029010	001018	2.0	100	23	2.7
029011	001019	2.5	110	32	3.5

Drill Guides

Compressional Drill Guides



MWI#	SECUROS#	PRODUCT DESCRIPTION
029016	001902	2.0mm Compressional Drill Guide
042238	001903	2.7mm Compressional Drill Guide
029018	001904	3.5mm Compressional Drill Guide

Universal Drill Guides



MWI#	SECUROS#	PRODUCT DESCRIPTION
042267	002279	3.5mm Universal Drill Guide

Depth Gauges

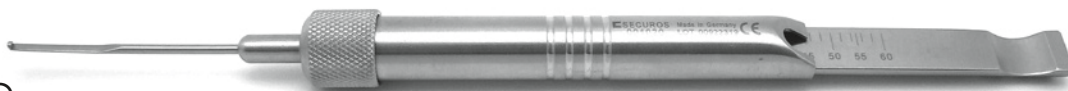

001020

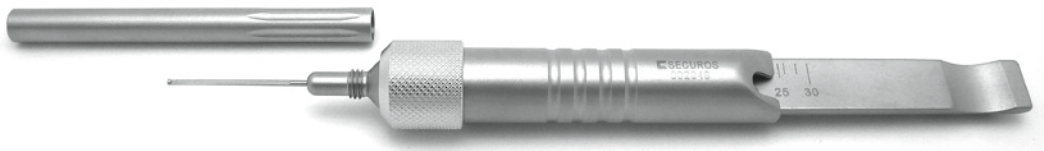

002049

MWI#	SECUROS#	PRODUCT DESCRIPTION	MEASURES UP TO (mm)	MEASUREMENT INCREMENTS (mm)
029097	002049	1.5/2.0/2.4mm Depth Gauge	30	2 & 5
029098	001020	2.7/3.5/4.0mm Depth Gauge	60	2 & 5
090001	005329	2.7/3.5/4.0mm Depth Gauge	60	1

Screwdrivers, Handles, & Shafts

Screwdrivers (Includes holding sleeve)



Cruciform



Hexagonal

MWI#	SECUROS#	PRODUCT DESCRIPTION	LENGTH (")
042292	002504	1.5/2.0mm Hexagonal Screwdriver	6.75
035880	003237	2.4mm Hexagonal Screwdriver	7
042073	001026	1.5/2.0/2.4mm Cruciform Screwdriver	7.75
029524	001024	2.7/3.5/4.0mm Hexagonal Screwdriver	7

Screwdriver Shafts (Quick Coupling, Includes holding sleeve)



004660

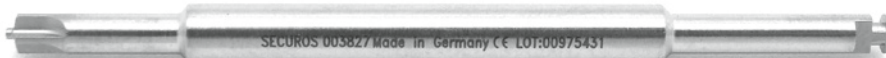

003827



001025

MWI#	SECUROS#	PRODUCT DESCRIPTION	FOR USE WITH	LENGTH (")
055058	004660	1.5/2.0mm Hexagonal Screwdriver Shaft	Mini QC Handle	2
056007	003827	1.5/2.0/2.4mm Cruciform Screwdriver Shaft	Mini QC Handle	2
055102	003904	2.4mm Hexagonal Screwdriver Shaft	Small, Large, Silicone QC Handles	4
029525	001025	2.7/3.5/4.0mm Hexagonal Screwdriver Shaft	Small, Large, Silicone QC Handles	4

Screwdrivers, Handles, & Shafts

Screwdriver Handles (Quick Coupling)



MWI#	SECUROS#	PRODUCT DESCRIPTION	ACCOMMODATES	LENGTH (")
042033	000123	Mini Handle	1.5/2.0mm Hexagonal & 1.5/2.0/2.4mm Cruciform Screwdriver Shafts	4.25



MWI#	SECUROS#	PRODUCT DESCRIPTION	ACCOMMODATES	LENGTH (")
029529	007003	Small Handle	2.7/3.5/4.0mm Hexagonal Screwdriver Shaft	4.5



MWI#	SECUROS#	PRODUCT DESCRIPTION	ACCOMMODATES	LENGTH (")
029528	001916	Large Handle	2.7/3.5/4.0mm Hexagonal Screwdriver Shaft	6



MWI#	SECUROS#	PRODUCT DESCRIPTION	ACCOMMODATES	LENGTH (")
052748	007180	Silicone Handle	2.7/3.5/4.0mm Hexagonal Screwdriver Shaft	5.5

Screwdriver Holding Sleeves



005502



003661

MWI#	SECUROS#	PRODUCT DESCRIPTION
052741	005502	1.5/2.0mm Standard Hexagonal Screwdriver Holding Sleeve
036057	003661	2.4mm Standard Hexagonal Screwdriver Holding Sleeve
043904	002190	2.7/3.5/4.0mm Standard Hexagonal Screwdriver Holding Sleeve

STERILIZATION CONTAINERS

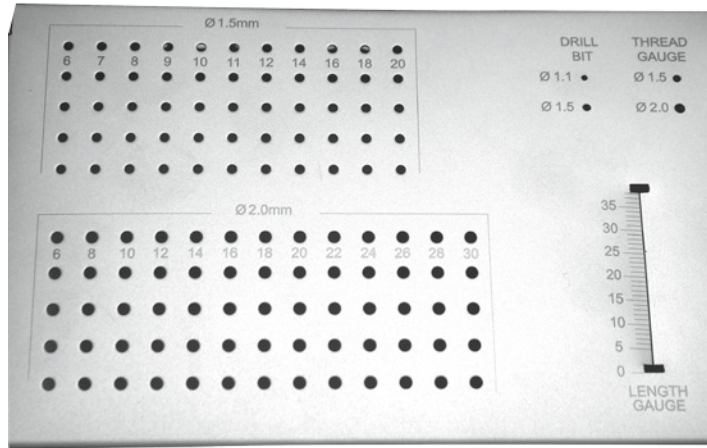

MWI#	SECUROS#	PRODUCT DESCRIPTION	LENGTH (")	WIDTH (")	HEIGHT (")
045549	000882	Screw Rack for 1.5/2.0mm Cortical Screws	6.25	4	2.25
ACCOMMODATES					
1.5mm Screws 5 ea.: 6mm-20mm (Increments of 2mm), 2.0mm Screws 5 ea.: 6mm-30mm (Increments of 2mm)					

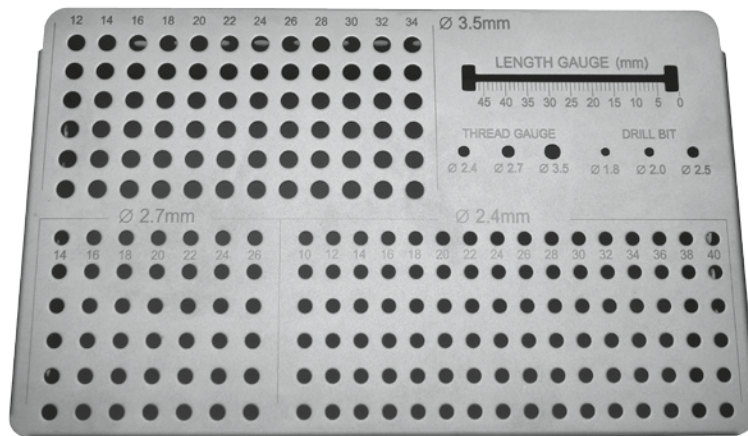

MWI#	SECUROS#	PRODUCT DESCRIPTION	LENGTH (")	WIDTH (")	HEIGHT (")
042069	000883	Screw Rack for 2.4/2.7/3.5mm Cortical Screws	6.25	4	2.25
ACCOMMODATES					
2.4mm Screws 6 ea.: 10mm-40mm (Increments of 2mm), 2.7mm Screws 6 ea.: 14mm-26mm (Increments of 2mm), 3.5mm Screws 6 ea.: 12mm-34mm (Increments of 2mm)					

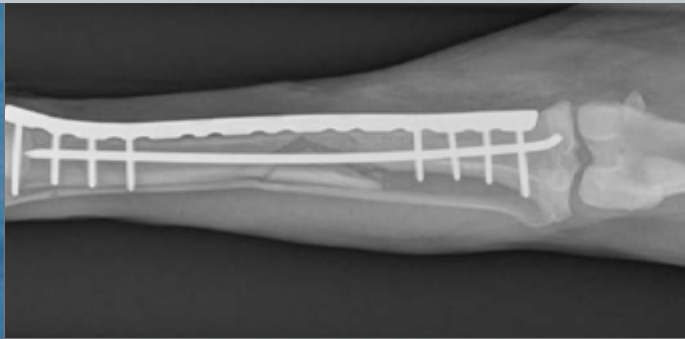

**Radiograph provided by Joshua Jackson, DVM, DACVS Veterinary Specialty Hospital San Diego, CA*

ORTHOPEDIC Trauma

External

Linear ESF System	172
Introduction.....	173
Implants	
ESF Pins.....	174
Instruments.....	176
Instruments for ESF.....	176
Pin Placement Devices.....	176
Drill Sleeves.....	176
Drill Bits.....	177
Clamps.....	178
Unilateral Augmentation System.....	180
Dynamization Bolts.....	181
Wrenches & Nut Drivers.....	181
Rods.....	182
FastFix.....	183
Sterilization Containers.....	184
Reference Materials.....	185

Internal

Introduction.....	186
Pin & Wire Management	188
Introduction.....	188
Implants.....	189
Kirshner Wires (K-wires).....	189
Steinmann/Intramedullary Pins.....	190
Cerclage Wire.....	191
Instruments.....	192
Dual Chucks.....	192
Wire Passers.....	192
Wire Twisters.....	193
Wire Benders.....	197
Pin/Wire Cutters.....	197
Pin Punches.....	200
Sterilization Containers.....	201
Organizer Bags.....	201
Reference Materials.....	201
Conventional Plate Osteosynthesis	202
Introduction.....	202
Implants.....	203
Straight Plates.....	203
Round Hole Plates.....	203
Dynamic Compression Plates.....	203
Limited Contact Dynamic Compression Plates.....	205

Internal

Specialty Plates.....	216
T-Plates.....	216
L-Plates.....	219
Acetabular Plates.....	220
Distal Femur Osteotomy Plates.....	221
Screws.....	222
Washers.....	234
Instruments.....	235
Instruments for Conventional Plating System..	235
Bending Instruments.....	236
Drill Bits.....	239
Taps & Countersinks.....	240
Drill Guides, Sleeves, & Inserts.....	241
Depth Gauges.....	243
Screwdrivers, Handles & Shafts.....	243
Screw Extraction Set.....	246
Sterilization Containers.....	248
Screw Racks & Cases.....	248
Plate Stringers.....	251
Reference Materials.....	251

Polyaxial Locking Plate Osteosynthesis	252
Introduction.....	252
Implants.....	254
Straight Plates.....	254
RP Plates.....	254
SP Plates.....	254
Specialty Plates.....	258
T-Plates.....	258
Butterfly Plates.....	258
Screws.....	259
Instruments.....	261
Instruments for PAX Locked Plating System	261
Plate Holding Forceps.....	261
Bending Instruments.....	261
Drill Bits.....	261
Drill Guides.....	262
Depth Gauges.....	262
Screwdrivers, Handles & Shafts.....	263
Sterilization Containers.....	264
Trays and Covers.....	264
Reference Materials.....	269

External Fixation

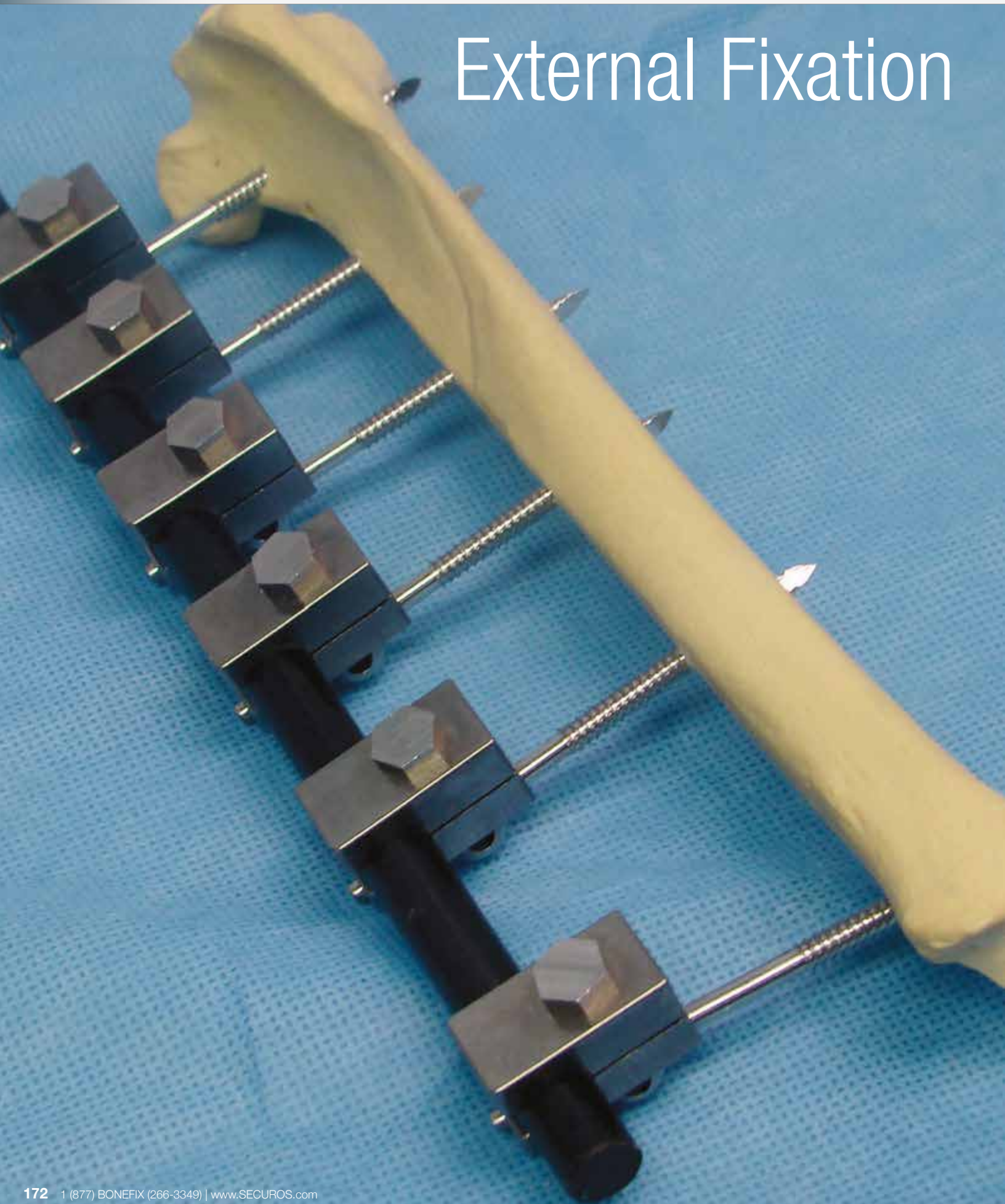

External Skeletal Fixation



TITAN Clamp

External Skeletal Fixation was first introduced in the 1840s. This type of fracture fixation relies on a variety of pins, clamps, and connecting bars to provide the stability that the bone needs to initiate the bone remodeling process. SECUROS has a complete range of external fixation products, available in two different styles to suit the needs of the surgeon; the TITAN system and the U Clamp system. Both systems have the ability to add or remove pins without disrupting the existing construct. The TITAN system is used with Carbon Fiber or Aluminum connecting rods, providing a lighter weight construct. The U clamp system is used with Stainless Steel connecting rods.



U Clamp

ESF Case Study



*Radiographs provided by Karl H. Kraus, DVM, MS, DACVS

IMPLANTS

End-Threaded Positive Profile ESF Pins

Micro ESF Pins - Stainless Steel

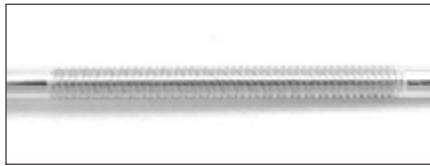

005089

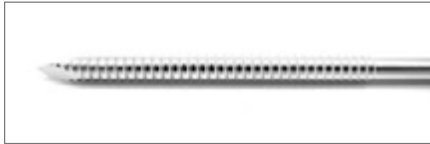

End - Threads



005089



001396



001801



001398



001803

Micro ESF Pins - Stainless Steel

MWI#	SECUROS#	SHANK DIAMETER (")	THREAD DIAMETER (")	THREAD LENGTH (")	ACRYLIC THREAD LENGTH (")	OVERALL LENGTH (")
049503	005089	.045	.055	.6	1.0	3
049504	005090	.062	.071	.6	1.0	3
049505	005091	5/64	.091	.6	1.0	3
049506	005092	3/32	.114	.8	1.0	3

Mini ESF Pins - Stainless Steel

MWI#	SECUROS#	SHANK DIAMETER (")	THREAD DIAMETER (")	THREAD LENGTH (")	OVERALL LENGTH (")	RECOMMENDED DRILL BIT (mm)
028970	001396	1/16	5/64	.5	3.5	1.5

Small ESF Pins - Stainless Steel

MWI#	SECUROS#	SHANK DIAMETER (")	THREAD DIAMETER (")	THREAD LENGTH (")	OVERALL LENGTH (")	RECOMMENDED DRILL BIT (mm)
028974	001801	3/32	.132	1.0	3.5	2.4

Medium ESF Pins - Stainless Steel

MWI#	SECUROS#	SHANK DIAMETER (")	THREAD DIAMETER (")	THREAD LENGTH (")	OVERALL LENGTH (")	RECOMMENDED DRILL BIT (mm)
028972	001398	1/8	.157	1.5	5.0	3.2

Large ESF Pins - Stainless Steel

MWI#	SECUROS#	SHANK DIAMETER (")	THREAD DIAMETER (")	THREAD LENGTH (")	OVERALL LENGTH (")	RECOMMENDED DRILL BIT (mm)
028976	001803	5/32	3/16	2.3	7.0	4.0

Center-Threaded Positive Profile ESF Pins

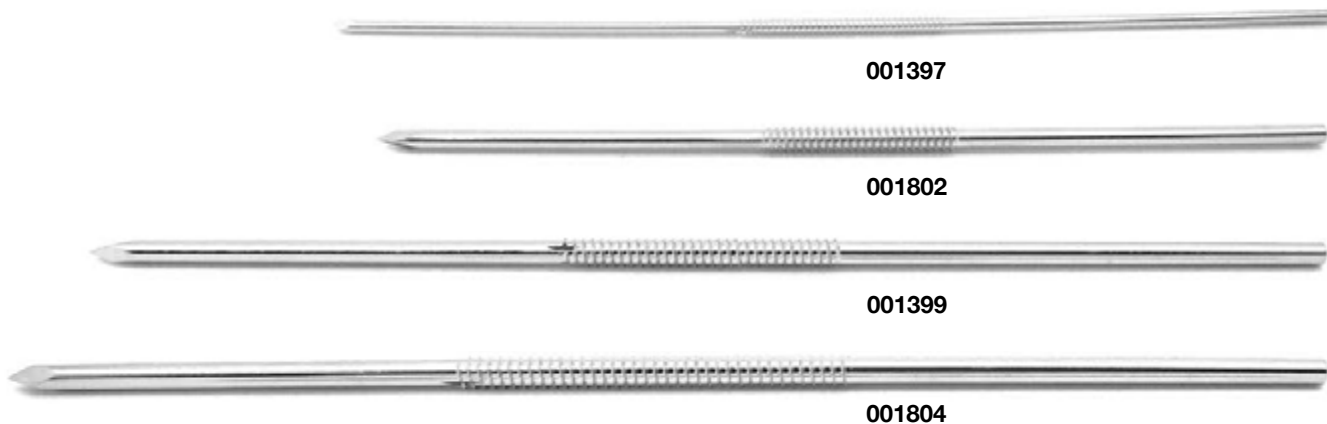

Center - Threads

Mini ESF Pins - Stainless Steel

MWI#	SECUIROS#	SHANK DIAMETER (")	THREAD DIAMETER (")	THREAD LENGTH (")	OVERALL LENGTH (")	RECOMMENDED DRILL BIT (mm)
028971	001397	1/16	5/64	1.0	5.0	1.5

Small ESF Pins - Stainless Steel

MWI#	SECUIROS#	SHANK DIAMETER (")	THREAD DIAMETER (")	THREAD LENGTH (")	OVERALL LENGTH (")	RECOMMENDED DRILL BIT (mm)
028975	001802	3/32	.132	1.0	5.0	2.4

Medium ESF Pins - Stainless Steel

MWI#	SECUIROS#	SHANK DIAMETER (")	THREAD DIAMETER (")	THREAD LENGTH (")	OVERALL LENGTH (")	RECOMMENDED DRILL BIT (mm)
028973	001399	1/8	.157	1.5	7.0	3.2

Large ESF Pins - Stainless Steel

MWI#	SECUIROS#	SHANK DIAMETER (")	THREAD DIAMETER (")	THREAD LENGTH (")	OVERALL LENGTH (")	RECOMMENDED DRILL BIT (mm)
028977	001804	5/32	3/16	2.3	8.0	4.0

INSTRUMENTS Pin Placement Devices

Pin Placement Devices for TITAN System



MWI#	SECUROS#	SIZE	FOR USE WITH PIN SIZE	INCLUDES DRILL SLEEVES (mm)	COLOR
056025	002360	Small	Mini, Small, Medium	1.5, 2.4, 3.2	Green
044056	001365	Large	Medium, Large	3.2, 4.0	Gold

Pin Placement Devices for U System

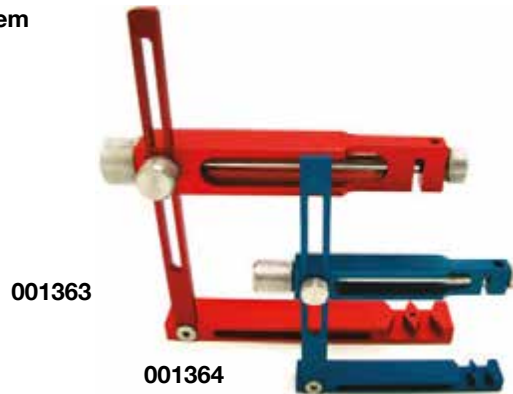

MWI#	SECUROS#	SIZE	FOR USE WITH PIN SIZE	INCLUDES DRILL SLEEVES (mm)	COLOR
031185	001364	Small	Mini, Small, Medium	1.5, 2.4	Blue
031184	001363	Large	Medium, Large	2.4, 3.2	Red

Drill Sleeves



MWI#	SECUROS#	FOR USE WITH DRILL BIT (mm)
055026	002359	1.5
029021	001230	2.4
■	001231	2.4 Extended
029022	001232	3.2
■ 370238	001233	3.2 Extended
048534	001234	4.0

■ special order item

Drill Bits

Jacobs Chuck Coupling (BITE Bit, Titanium Nitride Coated)



MWI#	SECUROS#	DIAMETER (mm)	TOTAL LENGTH (mm)	FLUTE LENGTH (mm)	RECOMMENDED PINS
031128	001359	1.5	140	32	Mini
031129	001358	2.4	140	32	Small
028992	001357	3.2	165	32	Medium
031130	001360	4.0	165	32	Large

Quick Coupling (BITE Bit, Titanium Nitride Coated)



MWI#	SECUROS#	DIAMETER (mm)	TOTAL LENGTH (mm)	FLUTE LENGTH (mm)	RECOMMENDED PINS
042056	000643	1.5	140	32	Mini
042090	001361	2.4	140	32	Small
045544	001362	3.2	165	32	Medium
045559	000644	4.0	165	32	Large

ESF Clamps

TITAN Clamps



MWI#	SECUROS#	PRODUCT DESCRIPTION	RECOMMENDED PINS
031020	002356	TITAN Small Single Clamp	Mini, Small, Medium
031019	001368	TITAN Large Single Clamp	Medium, Large

U Clamps

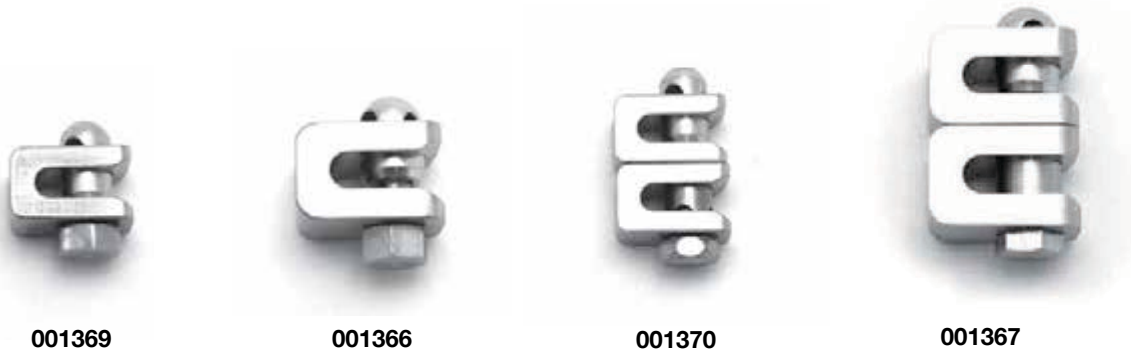

MWI#	SECUROS#	PRODUCT DESCRIPTION	RECOMMENDED PINS
031018	001369	Small Single Clamp	Mini, Small
031016	001366	Large Single Clamp	Medium, Large
031132	001370	Small Double Clamp	Mini, Small
031131	001367	Large Double Clamp	Medium, Large

ESF Clamp Individual Replacement Components

TITAN Clamp Replacement Components

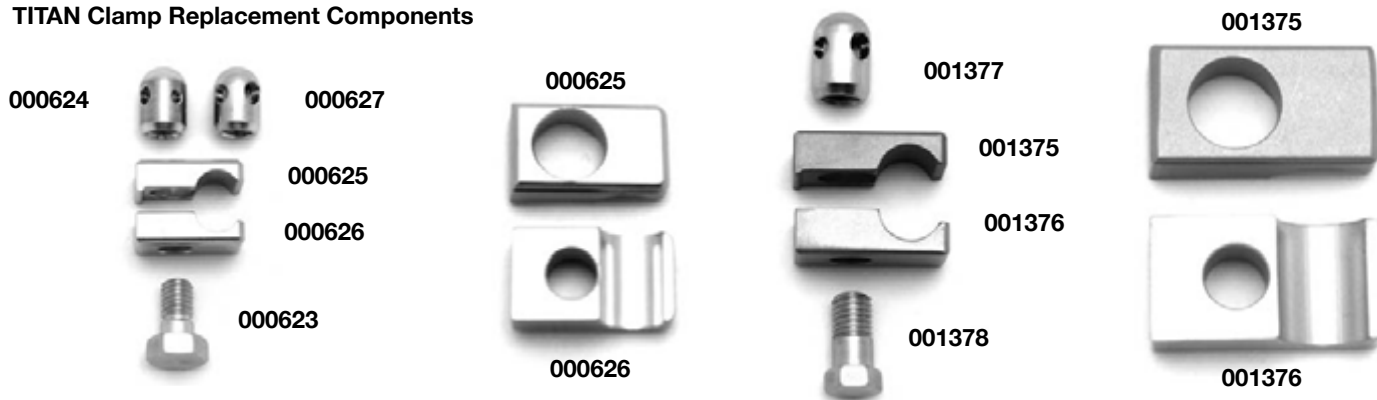

MWI#	SECUROS#	PRODUCT DESCRIPTION
048504	000624	TITAN Small Clamp Mini/Small Head Component
■ 370239	000627	TITAN Small Clamp Small/Medium Head Component
■ 276664	000625	TITAN Small Clamp Top Piece
■ 276665	000626	TITAN Small Clamp Bottom Piece
045533	000623	TITAN Small Clamp Bolt
042092	001377	TITAN Large Clamp Head Component
■ 372096	001375	TITAN Large Clamp Top Piece
■ 372097	001376	TITAN Large Clamp Bottom Piece
042093	001378	TITAN Large Clamp Bolt

U Clamp Replacement Components



MWI#	SECUROS#	PRODUCT DESCRIPTION
049885	001379	Small Pin Head Component
045522	001380	Small Connecting Rod U Component
042094	001381	Small Clamp Bolt
042091	001371	Large Pin Head Component
056011	001372	Large Connecting Rod U Component
056010	001373	Large Clamp Bolt
■ 372098	001382	Small Double Clamp Component
■ 372099	001374	Large Double Clamp Component

■ special order item

Unilateral Augmentation System

Unilateral Augmentation Clamps

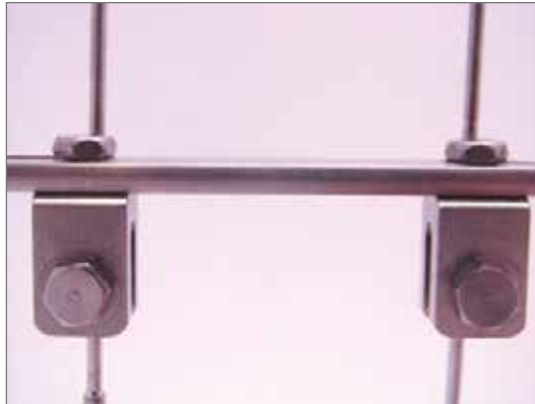

MWI#	SECUROS#	PRODUCT DESCRIPTION
056018	001209	Small Unilateral Augmentation Clamp
045554	001203	Unilateral Augmentation Clamp

Unilateral Augmentation Clamp Replacement Components

MWI#	SECUROS#	PRODUCT DESCRIPTION	HEAD SIZE (")
■ 372100	003887	Small Top Screw	1/4
048146	002963	Large Top Screw	5/16

Augmentation Plates - Stainless Steel



MWI#	SECUROS#	PRODUCT DESCRIPTION	CLAMP SPAN (")
■ 370242	011205	Small	1-2
045432	001206	Small	2-3
048531	001207	Small	3-4
048532	001208	Small	4-5
048529	001201	Small	5-6
048530	001202	Small	6-7
045126	002088	Large	1-2
048548	002089	Large	2-3
045127	002090	Large	3-4
048549	002091	Large	4-5

■ special order item

Dynamization Bolts



001383



MWI#	SECUROS#	PRODUCT DESCRIPTION	HEAD SIZE (")
045576	001384	Small	1/4
036064	001383	Large	5/16

Wrenches & Nut Drivers

For Use With All ESF Systems



001222



001221

MWI#	SECUROS#	PRODUCT DESCRIPTION
031187	001222	Precision Torque Wrench with Socket
■ 372101	000836	Precision Torque Wrench without Socket
■ 276468	001223	Socket for Precision Torque Wrench
029020	001221	1/4" x 5/16" Double Open Ended Wrench

Nut Drivers



001224



001225

MWI#	SECUROS#	PRODUCT DESCRIPTION	SOCKET SIZE (")
■ 372102	001224	Small	1/4
■ 372103	001225	Large	5/16

■ special order item

Connecting Rods

Stainless Steel Connecting Rods



MWI#	SECUROS#	DIAMETER	LENGTH (")
028978	001806	1/8" (3.2mm)	2
028979	001807	1/8" (3.2mm)	3
028980	002178	1/8" (3.2mm)	4
028981	002097	1/8" (3.2mm)	5
028982	002098	1/8" (3.2mm)	6
028983	002099	1/8" (3.2mm)	8
028984	002100	1/8" (3.2mm)	10
028985	002201	3/16" (4.8mm)	4
028986	002202	3/16" (4.8mm)	6
028987	002203	3/16" (4.8mm)	8
028988	002204	3/16" (4.8mm)	10
028989	002205	3/16" (4.8mm)	12
028990	002206	3/16" (4.8mm)	14

Carbon Fiber Connecting Rods



MWI#	SECUROS#	DIAMETER	LENGTH (")
031175	002347	3/16" (4.8mm)	4
031176	002348	3/16" (4.8mm)	6
031177	002349	3/16" (4.8mm)	8
031178	002350	3/16" (4.8mm)	10
031179	002351	1/4" (6.3mm)	2
031180	002352	1/4" (6.3mm)	4
031181	002353	1/4" (6.3mm)	6
031182	002354	1/4" (6.3mm)	8
031183	002355	1/4" (6.3mm)	10
044612	002212	3/8" (9.5mm)	2
030966	002213	3/8" (9.5mm)	4
031125	002214	3/8" (9.5mm)	6
031126	002215	3/8" (9.5mm)	8
030967	002216	3/8" (9.5mm)	10
030968	002217	3/8" (9.5mm)	12
045470	002218	3/8" (9.5mm)	14

■ special order item

Connecting Rods

Aluminum Connecting Rods



MWI#	SECUROS#	DIAMETER	LENGTH (")
044925	002207	3/8" (9.5mm)	4
090012	022208	3/8" (9.5mm)	6
044926	002209	3/8" (9.5mm)	8
044928	002346	3/8" (9.5mm)	10
055093	002210	3/8" (9.5mm)	12
044927	002211	3/8" (9.5mm)	14

FastFix Putty



CUT



KNEAD



APPLY

FastFix is a fast-setting, high-strength polymer compound that enables fast, simple, inexpensive external fixation repairs. The polymer can replace both the connecting bar and the external fixation clamp or solely the external fixation clamp.

Each unit contains pre-measured portions of the activator and base throughout—no measuring or mixing tools are necessary. As the polymer is mixed, the two contrasting colors blend into one color and indicate complete mixing. The consistency (like modeling clay) eliminates drips and runs and allows the material to be shaped and formed as needed before curing begins.

FastFix polymer contains no solvents or VOCs. It is non-flammable and does not release noxious fumes. The unused portion stays fresh for future use when saved in its original package.

- Easy to use and very inexpensive
- Bonds instantly with superior strength
- No mixing tools required
- No odor
- Allows ESF pins to be placed at various angles and locations
- Ideal for mandible fractures
- Gas sterilize only

MWI#	SECUROS#	VOLUME PER TUBE
030031	002219	0.25oz



STERILIZATION CONTAINERS

Sterilization Trays

Plastic Cases (Includes Silicone Mat)

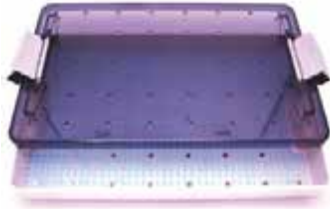

001330



001332



001331

MWI#	SECUROS#	LENGTH (")	WIDTH (")	HEIGHT (")
■ 276469	004176	7	2	.75
043918	001330	11.25	6.75	2
045114	001332	15	10	2.5
045434	001331	20.75	10	2.5

Organizer Bags



MWI#	SECUROS#	PRODUCT DESCRIPTION
031191	002932	Small ESF Organizer Bag
ACCOMMODATES		
Small Pin Placement Device for U System, Connecting Rods 2 ea.: 1/8" x 4", 1/8" x 5", 1/8" x 6", 2.4mm Drill Bit, Center Threaded & End Threaded ESF Pins: 6 ea., Small U Clamps: 20, Double Ended Wrench, 2.4mm Drill Sleeve		

MWI#	SECUROS#	PRODUCT DESCRIPTION
031189	001394	Large ESF Organizer Bag
ACCOMMODATES		
Large Pin Placement Device for U System, Connecting Rods 2 ea.: 3/16" x 6", 3/16" x 8", 3/16" x 10", 3.2mm Drill Bit, Center Threaded & End Threaded ESF Pins: 6 ea., Large U Clamps: 20, Double Ended Wrench, 2.4mm Drill Sleeve, 3.2mm Drill Sleeve		

REFERENCE MATERIALS

External Skeletal Fixation



Clamps				Connecting Rods			
00144	00145	00128	00129	1/2"	5/8"	3/4"	3/4"
Mini End Clamp	Small End Clamp	Large End Clamp	Small End Clamp	(1.27cm)	(1.27cm)	(1.90cm)	(1.90cm)
Pins							
Part Number	Description	Shank Diameter	Thread Diameter	Thread Length	Overall Length	Recommended Drill Bit	
00136	Mini End Threaded EP Pin	5/16" (1.56cm)	3/4" (1.90cm)	1/2" (1.27cm)	4.1" (10.41cm)	1.5mm	
00137	Mini Center Threaded EP Pin	5/16" (1.56cm)	3/4" (1.90cm)	1.0" (2.54cm)	3.0" (7.62cm)	1.5mm	
00138	Small End Threaded EP Pin	5/16" (1.56cm)	1.0" (2.54cm)	1.0" (2.54cm)	3.1" (7.87cm)	2.0mm	
00139	Small Center Threaded EP Pin	5/16" (1.56cm)	1.0" (2.54cm)	1.0" (2.54cm)	3.0" (7.62cm)	2.0mm	

External Skeletal Fixation



Clamps				Connecting Rods			
00136	00137	00128	00129	1/2"	5/8"	3/4"	3/4"
Mini End Clamp	Small End Clamp	Large End Clamp	Small End Clamp	(1.27cm)	(1.27cm)	(1.90cm)	(1.90cm)
Pins							
Part Number	Description	Shank Diameter	Thread Diameter	Thread Length	Overall Length	Recommended Drill Bit	
00136	Medium End Threaded EP Pin	5/8" (1.59cm)	1.0" (2.54cm)	1.5" (3.81cm)	3.0" (7.62cm)	2.0mm	
00139	Medium Center Threaded EP Pin	5/8" (1.59cm)	1.0" (2.54cm)	1.5" (3.81cm)	3.0" (7.62cm)	2.0mm	
00138	Large End Threaded EP Pin	5/8" (1.59cm)	1.5" (3.81cm)	1.0" (2.54cm)	3.0" (7.62cm)	2.0mm	
00139	Large Center Threaded EP Pin	5/8" (1.59cm)	1.5" (3.81cm)	1.0" (2.54cm)	3.0" (7.62cm)	2.0mm	

MWI#	SECUROS#	PRODUCT DESCRIPTION
042095	001386	External Skeletal Fixation Instructional CD-ROM
■ 388998	005494	External Skeletal Fixation Order Reference Guide

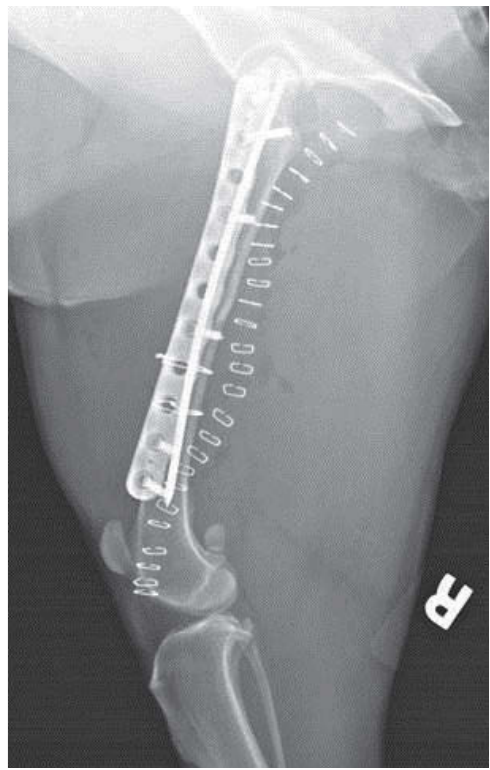
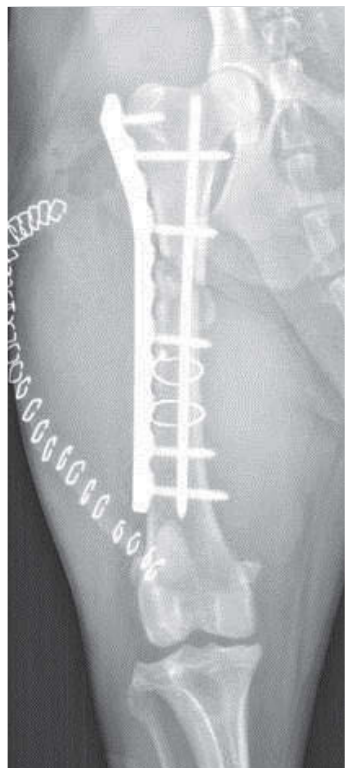
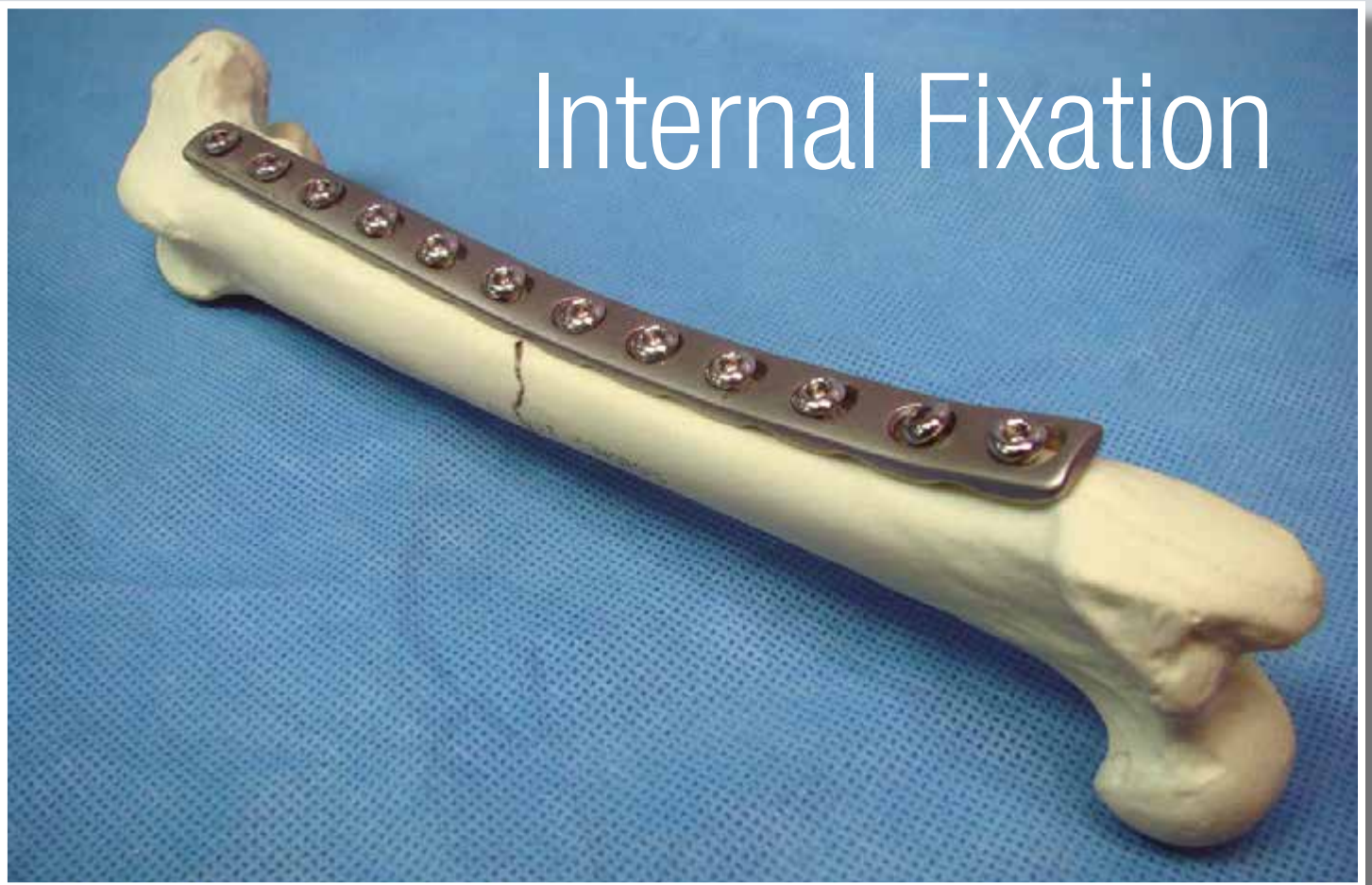

Pin & Wire Management

Pins and wires were some of the earliest forms of internal fixation. Today, pins and wires are often used in conjunction with other forms of internal fixation, however, they can be used alone to treat specific fractures.

SECUROS pins are made using a unique manufacturing process that render the trocar tips concave instead of flat. This creates a sharper cutting edge and 30% reduction in heat generation as compared to traditional pins.



Conventional Plate Osteosynthesis

Conventional plates for internal fixation were first introduced in the 1960s. They act like internal splints that hold broken pieces of bone together. Plates are attached to the bone with screws and rely on friction between the screw and bone for stability. Alternatively, screws alone can be used to hold together specific fractures.

SECUROS is proud to offer conventional plating implants and instrumentation that follow AO/ASIF/ASTM/ISO standards. Our conventional plating offering is manufactured in FDA approved facilities that also serve the human orthopedic industry.

*Radiographs provided by Joshua Jackson, DVM, DACVS Veterinary Specialty Hospital, San Diego, CA.

Polyaxial Locking Plate Osteosynthesis

Locking plates are a newer technology to veterinary medicine, having only been commercially available since the 2000's. Unlike conventional plates and screws, locking plates and screws create fixed angles that do not rely on screw purchase in bone. The threads of the head of the locking screws mate with the holes in the plate to form a rigid, fixed-angle construct.

SECUROS is the first and only veterinary company to offer patented polyaxial locking plate osteosynthesis with the PAX system. Features of the PAX system over traditional locking plate systems include polyaxial locking up to 10 degrees, titanium alloy implants, interchangeable screws between 2.0/2.4mm and 2.7/3.5mm systems, and the ability to remove screws and adjust angulation. Newly introduced in 2014 was our complete SP (Straight Plate) line of PAX implants, instruments, and trays.





SECUROS Pin & Wire Options

Wide **variety** of pin and wire sizes available for any **application**

- **Proprietary** manufacturing process yields more symmetrical trocar cutting edges for **accurate placement**
- Concave trocar tips result in a **sharper** cutting edge
- 30% **reduction** in **heat** generation as compared to traditional pins and wire

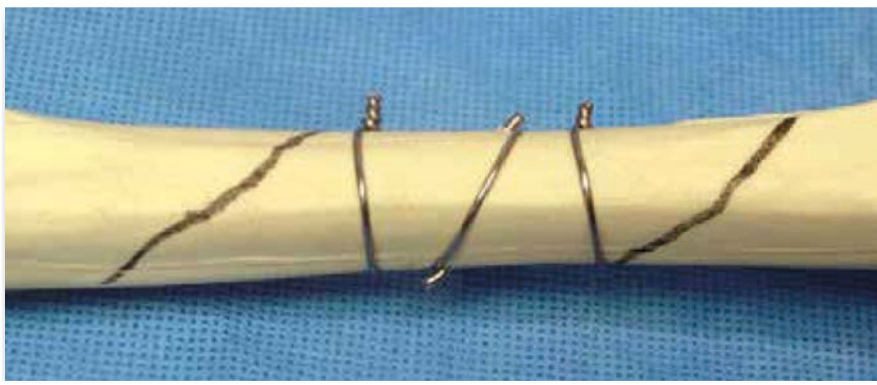

IMPLANTS

Kirschner Wire (K-wire) (Smooth, Trocar/Trocar) - Stainless Steel

**.028"**

MWI#	SECUROS#	UNIT	LENGTH (")
049153	005330	Pack of 10	5
055078	005331	Pack of 6	9

.035"

MWI#	SECUROS#	UNIT	LENGTH (")
055110	004853	Pack of 10	5
029089	001277	Pack of 6	9

.045"

MWI#	SECUROS#	UNIT	LENGTH (")
055111	004854	Pack of 10	5
029090	001278	Pack of 6	9

.054"

MWI#	SECUROS#	UNIT	LENGTH (")
052747	004855	Pack of 10	5
029091	001279	Pack of 6	9

.062"

MWI#	SECUROS#	UNIT	LENGTH (")
055112	004856	Pack of 10	5
029092	001280	Pack of 6	9

.075"

MWI#	SECUROS#	UNIT	LENGTH (")
055113	004857	Pack of 6	9

Steinmann/Intramedullary Pins - Stainless Steel



1/16"

MWI#	SECUROS#	STYLE	LENGTH (")	TROCAR
044962	004270	Smooth	4.5	Single End
029057	001235	Smooth	9	Double End
042426	004271	Partially Threaded	4.5	Single End
029068	001257	Partially Threaded	9	Double End

5/64"

MWI#	SECUROS#	STYLE	LENGTH (")	TROCAR
031011	002986	Smooth	4.5	Single End
029058	001236	Smooth	9	Double End
■ 372086	005485	Partially Threaded	4.5	Single End
029069	001258	Partially Threaded	9	Double End

3/32"

MWI#	SECUROS#	STYLE	LENGTH (")	TROCAR
048256	003587	Smooth	4.5	Single End
029059	001237	Smooth	9	Double End
029066	001244	Smooth	12	Double End
031008	001251	Smooth	14	Double End
035918	003586	Partially Threaded	4.5	Single End
029070	001259	Partially Threaded	9	Double End

7/64"

MWI#	SECUROS#	STYLE	LENGTH (")	TROCAR
■ 372087	005487	Smooth	4.5	Single End
029060	001238	Smooth	9	Double End
031012	001245	Smooth	12	Double End
031013	001252	Smooth	14	Double End
■ 372088	005486	Partially Threaded	4.5	Single End
029071	001260	Partially Threaded	9	Double End

1/8"

MWI#	SECUROS#	STYLE	LENGTH (")	TROCAR
031003	003099	Smooth	4.5	Single End
029061	001239	Smooth	9	Double End
031001	001246	Smooth	12	Double End
031002	001253	Smooth	14	Double End
031005	002985	Partially Threaded	4.5	Single End
029072	002956	Partially Threaded	9	Double End
042412	003963	Partially Threaded	12	Double End

9/64"

MWI#	SECUROS#	STYLE	LENGTH (")	TROCAR
029062	001240	Smooth	9	Double End
031014	001247	Smooth	12	Double End
031015	001254	Smooth	14	Double End
029073	002957	Partially Threaded	9	Double End
044613	003964	Partially Threaded	12	Double End

5/32"

MWI#	SECUROS#	STYLE	LENGTH (")	TROCAR
029063	001241	Smooth	9	Double End
031009	001248	Smooth	12	Double End
031010	001255	Smooth	14	Double End
029074	001261	Partially Threaded	9	Double End
042413	003965	Partially Threaded	12	Double End

3/16"

MWI#	SECUROS#	STYLE	LENGTH (")	TROCAR
029064	001242	Smooth	9	Double End
029067	001249	Smooth	12	Double End
031007	001256	Smooth	14	Double End
029075	001262	Partially Threaded	9	Double End
039177	003966	Partially Threaded	12	Double End

1/4"

MWI#	SECUROS#	STYLE	LENGTH (")	TROCAR
029065	001243	Smooth	12	Double End
029076	001263	Partially Threaded	12	Double End

■ special order item

Orthopedic Wire - Stainless Steel

Orthopedic Wire (1 oz Spool, Autoclavable)



MWI#	SECUROS#	DIAMETER
048241	003720	36 Gauge
048240	003719	34 Gauge
045175	003718	32 Gauge
045493	003717	30 Gauge
045051	003716	28 Gauge
029082	001269	26 Gauge
029081	001268	24 Gauge
029080	001267	22 Gauge
029079	001266	20 Gauge
029078	001265	18 Gauge
029077	001264	16 Gauge

Orthopedic Wire (4 oz Spool, Autoclavable)

MWI#	SECUROS#	DIAMETER
029088	001276	26 Gauge
029087	001275	24 Gauge
029086	001274	22 Gauge
029085	001273	20 Gauge
029084	001272	18 Gauge
029083	001271	16 Gauge

Orthopedic Wire with Loop (Pack of 10)



MWI#	SECUROS#	DIAMETER
031000	002917	22 Gauge
030999	002982	20 Gauge
030998	002981	18 Gauge
030997	002980	16 Gauge

INSTRUMENTS

Dual Chuck Hand Chucks



001480



001479



005015

MWI#	SECUROS#	PRODUCT DESCRIPTION	LENGTH (")
029519	001480	Mini Dual Chuck Hand Chuck	5.75
029517	001479	Dual Chuck Hand Chuck	6.5
049103	004818	Replacement Screwdriver for Hand Chucks	8
029521	001482	Replacement Key for Dual Chuck Hand Chuck	2
■ 370236	002988	Replacement Key for Mini Dual Chuck Hand Chuck	1.75
047958	005015	Jacobs Chuck Key Extension Handle	5.5

Wire Passers



MWI#	SECUROS#	FEATURE	LENGTH (")
045515	840413	Cannulated Double Ended	6



MWI#	SECUROS#	FEATURE	LENGTH (")
049222	840414	Cannulated Single Ended	7



MWI#	SECUROS#	FEATURE	LENGTH (")
045567	000399	Cannulated Single Ended, Phenolic Handle	9.5



MWI#	SECUROS#	FEATURE	LENGTH (")
■ 372104	840416	Hole in tip, Solid Handle	8.75

■ special order item

Wire Twisters

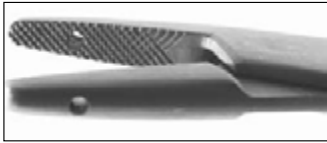

MWI#	SECUROS#	FEATURE	LENGTH (")
045081	840390	Holes in Tip	6.5



MWI#	SECUROS#	FEATURE	LENGTH (")
056034	001461	Blunt, Tungsten Carbide Inserts	7



MWI#	SECUROS#	FEATURE	LENGTH (")
045437	840393	Lateral Jaw, Tungsten Carbide Inserts	6.75



MWI#	SECUROS#	PRODUCT DESCRIPTION	FEATURE	LENGTH (")
049217	840394	Corwin Blunt	Tungsten Carbide Inserts	6

Wire Twisters



MWI#	SECUROS#	FEATURE	LENGTH (")
043938	003542	Double Wire Twister, Wooden Handle	10

Wire Tightener



MWI#	SECUROS#	PRODUCT DESCRIPTION	LENGTH (")
043913	001704	Cerclage Wire Tightener	4.75"

Parallel Pliers



840370



840371

MWI#	SECUROS#	FEATURE	LENGTH (")
090034	840370	—	7
045348	840371	Wire Cutters	7

Wire Twisters

Vise Grip Locking Pliers



MWI#	SECUROS#	LENGTH (")
045287	840372	7
049212	840373	8
049213	840374	9.5

Vise Grip Locking Needle Nose Pliers



MWI#	SECUROS#	LENGTH (")
090071	840367	8.5
049210	840368	10
049211	840369	12

Wire Twisters

Needle Nose Pliers



Delicate



Tapped



Wide Jaw

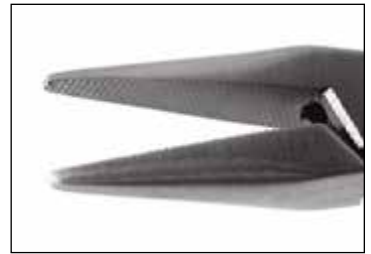

Serrated

MWI#	SECUROS#	FEATURE	LENGTH (")
090036	840377	Delicate	5.5
049214	840378	Tapped	5.5
■ 372105	840379	Wide Jaw	5.5
045023	840380	Serrated	5.5

Flat Nose Pliers



840381



840382



MWI#	SECUROS#	FEATURE	LENGTH (")
049215	840381	2mm Tip	6
■ 372106	840382	2mm Tip, Smooth Jaw	6

■ special order item

Wire Benders



MWI#	SECUROS#	PRODUCT DESCRIPTION	FOR USE WITH
055140	840929	Universal K-wire Bender	.035"/.015"/.054"/.062" K-wires



MWI#	SECUROS#	PRODUCT DESCRIPTION	FOR USE WITH
390152	002062	Double K-wire Bender	0.054"/0.062" K-wires

Pin/Wire Cutters

Side Pin/Wire Cutters



MWI#	SECUROS#	FEATURE	MAXIMUM PIN SIZE (")	LENGTH(")
045293	840403	Single Action	5/64	5.75

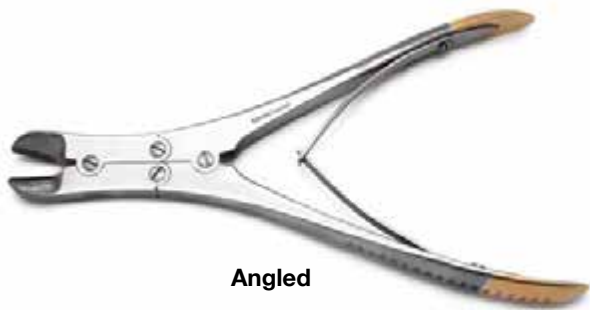

Angled

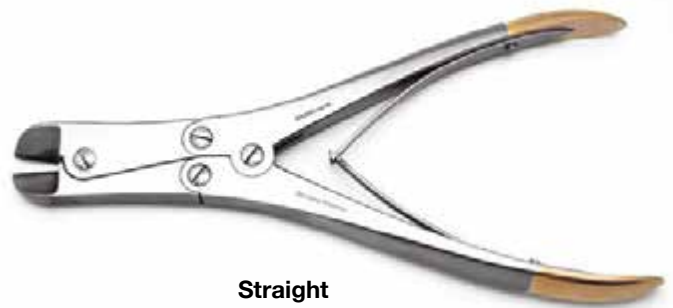

Straight

MWI#	SECUROS#	FEATURE	MAXIMUM PIN SIZE (")	LENGTH(")
042096	840406	Angled	5/64	7
045027	840404	Angled	7/64	8.75
035820	840405	Straight	7/64	9.25

Pin/Wire Cutters

Side Pin/Wire Cutters



MWI#	SECUROS#	PRODUCT DESCRIPTION	MAXIMUM PIN DIAMETER (")	LENGTH (")
048648	840843	"Hercules", Tungsten Carbide Inserts	7/64	9.25



MWI#	SECUROS#	MAXIMUM PIN DIAMETER (")	LENGTH (")
045561	003890	1/8	15



MWI#	SECUROS#	MAXIMUM PIN DIAMETER (")	LENGTH (")
045028	840407	1/4	18.5



MWI#	SECUROS#	PRODUCT DESCRIPTION	MAXIMUM PIN DIAMETER (")	LENGTH (")
036209	001458	Detachable Handles	1/4	18.5

Pin/Wire Cutters

Front/Side Pin/Wire Cutters

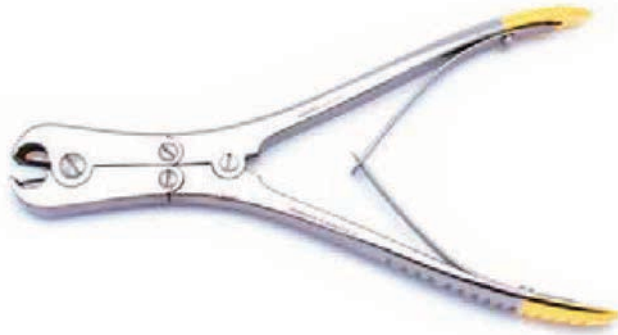

MWI#	SECUROS#	FEATURE	MAXIMUM PIN DIAMETER (")	LENGTH (")
045292	840402	Tungsten Carbide Inserts	1/16	7.5

Front Pin/Wire Cutters



MWI#	SECUROS#	FEATURE	MAXIMUM PIN DIAMETER (")	LENGTH (")
048374	840927	Cannulated	1/16	7.5



MWI#	SECUROS#	FEATURE	MAXIMUM PIN DIAMETER (")	LENGTH (")
045538	001555	Tungsten Carbide Inserts	7/64	8.75



MWI#	SECUROS#	MAXIMUM PIN DIAMETER (")	LENGTH (")
■ 276424	003759	1/8	10

Pin Punches

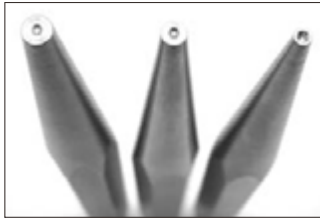

001469 001468 001470



MWI#	SECUROS#	FOR USE WITH PIN SIZE (")	LENGTH (")
043910	001469	3/32	7
044007	001468	1/8	7
044609	001470	5/32	7

IM Pin Starter Kits (Steinmann/Intramedullary)

MWI# 031137, SECUROS# 004021, Smooth IM Pin Starter Kit

MWI#	SECUROS#	PRODUCT DESCRIPTION	QTY
029089	001277	0.035" x 9" K-Wire, Pack of 6	1
029090	001278	0.045" x 9" K-Wire, Pack of 6	1
029092	001280	0.062" x 9" K-Wire, Pack of 6	1
029058	001236	5/64" x 9" Smooth IM Pin, Trocar/Trocar	2
029059	001237	3/32" x 9" Smooth IM Pin, Trocar/Trocar	2
029060	001238	7/64" x 9" Smooth IM Pin, Trocar/Trocar	2
029061	001239	1/8" x 9" Smooth IM Pin, Trocar/Trocar	2
029062	001240	9/64" x 9" Smooth IM Pin, Trocar/Trocar	2
029063	001241	5/32" x 9" Smooth IM Pin, Trocar/Trocar	2
029064	001242	3/16" x 9" Smooth IM Pin, Trocar/Trocar	2
029065	001243	1/4" x 12" Smooth IM Pin, Trocar/Trocar	2
029080	001267	22 Gauge/0.025" Orthopedic Wire, 1 oz. Spool	1
029079	001266	20 Gauge/0.032" Orthopedic Wire, 1 oz. Spool	1
029078	001265	18 Gauge/0.040" Orthopedic Wire, 1 oz. Spool	1
029077	001264	16 Gauge/0.048" Orthopedic Wire, 1 oz. Spool	1
029522	001488	IM Pin Organizer Bag	1
029089	001277	0.035" x 9" K-Wire, Pack of 6	1

MWI# 031136, SECUROS# 003175, Partially Threaded IM Pin Starter Kit

MWI#	SECUROS#	PRODUCT DESCRIPTION	QTY
029090	001278	0.045" x 9" K-Wire, Pack of 6	1
029092	001280	0.062" x 9" K-Wire, Pack of 6	1
029057	001257	1/16" x 9" Partially Threaded IM Pin, Trocar/Trocar	2
029069	001258	5/64" x 9" Partially Threaded IM Pin, Trocar/Trocar	2
029070	001259	3/32" x 9" Partially Threaded IM Pin, Trocar/Trocar	2
029071	001260	7/64" x 9" Partially Threaded IM Pin, Trocar/Trocar	2
029072	002956	1/8" x 9" Partially Threaded IM Pin, Trocar/Trocar	2
029073	002957	9/64" x 9" Partially Threaded IM Pin, Trocar/Trocar	2
029074	001261	5/32" x 9" Partially Threaded IM Pin, Trocar/Trocar	2
029075	001262	3/16" x 9" Partially Threaded IM Pin, Trocar/Trocar	2
029076	001263	1/4" x 12" Partially Threaded IM Pin, Trocar/Trocar	2
029080	001267	22 Gauge/0.025" Orthopedic Wire, 1 oz. Spool	1
029079	001266	20 Gauge/0.032" Orthopedic Wire, 1 oz. Spool	1
029078	001265	18 Gauge/0.040" Orthopedic Wire, 1 oz. Spool	1
029077	001264	16 Gauge/0.048" Orthopedic Wire, 1 oz. Spool	1
029522	001488	IM Pin Organizer Bag	1

STERILIZATION CONTAINERS

Organizer Bags



MWI#	SECUROS#	PRODUCT DESCRIPTION
031190	001487	Pin Punch Organizer Bag
ACCOMODATES		
3/32" Pin Punch, 1/8" Pin Punch, 5/32" Pin Punch, Mallet		

MWI#	SECUROS#	PRODUCT DESCRIPTION
043926	001492	Bone Wire Organizer Bag
ACCOMODATES		
Needle Nose Pliers, Cerclage Wire Passer, Vice Grip Pliers, Parallel Pliers, Large Needle Drivers, Front Pin Cutter, (4) K-wire packs of 6, (4) Spools of 1oz wire.		

MWI#	SECUROS#	PRODUCT DESCRIPTION
029522	001488	IM Pin Organizer Bag
ACCOMODATES		
(18) Smooth or Partially Threaded IM Pins, (4) K-wire Packs of 6, (4) Spools of 1oz wire.		

REFERENCE MATERIALS

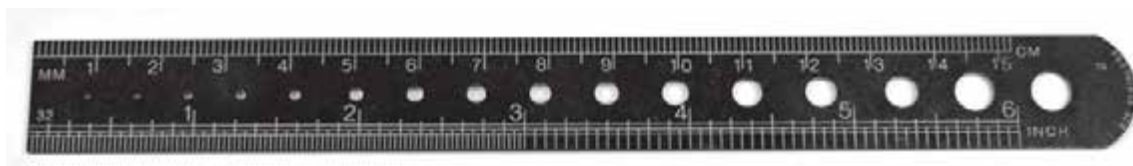

MWI#	SECUROS#	PRODUCT DESCRIPTION
031135	840415	Pin & K-Wire Gauge/Ruler



SECUROS

Anything but Conventional

Complete offering of straight & specialty plates, screws, washers, instruments and sterilization containers

- **Manufactured** according to ASTM, ISO and FDA **standards**
- **Available** in sizes as small as 1.5mm and as large as 6.5mm
- Fully **compatible with AO** implants and instruments



IMPLANTS

1.5mm Conventional Straight Plates

1.5mm Round Hole Cut-to-Length Plate - Stainless Steel



Width: 3.8mm

Thickness: 0.8mm

Distance Between Center of Holes: 5.0mm

MWI#	SECUROS#	# OF HOLES	LENGTH (mm)
042231	001852	20	100

1.5mm Dynamic Compression Plates - Stainless Steel



Width: 3.8mm

Distance Between Center of Holes: 5.0mm

Distance Between Central Holes: 7.0mm

MWI#	SECUROS#	# OF HOLES	LENGTH (mm)	THICKNESS (mm)
042228	001849	4	23	1.0
042229	001850	5	28	1.0
029133	001851	6	33	1.0
042406	003804	7	38	1.5
042407	003805	8	43	1.5
044005	003806	9	48	1.5
044004	003807	10	53	1.5

2.0mm Conventional Straight Plates

2.0mm Round Hole Cut-to-Length Plate - Stainless Steel



Width: 5.0mm

Thickness: 1.2mm

Distance Between Center of Holes: 5.0mm

MWI#	SECUROS#	# OF HOLES	LENGTH (mm)
029206	002480	20	100

2.0/2.4/2.7mm Round Hole Semi-Tubular Cut-to-Length Plate - Stainless Steel



Width: 7.0mm

Thickness: 1.5mm

Distance Between Center of Holes: 6.0mm

MWI#	SECUROS#	# OF HOLES	LENGTH (mm)
042331	003475	50	300

2.0mm Round Hole Reconstruction Plate - Stainless Steel



Width: 5.4mm

Thickness: 1.0mm

Distance Between Center of Holes: 5.0mm

MWI#	SECUROS#	# OF HOLES	LENGTH (mm)
042316	003103	20	100

2.0mm Conventional Straight Plates

2.0mm Round Hole Lengthening Plates - Stainless Steel

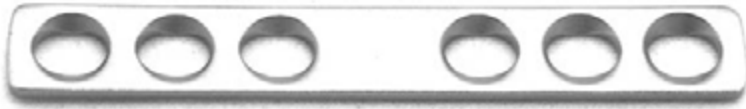

Width: 5.0mm

Thickness: 1.0mm

Distance Between Center of Holes: 5.0mm

Distance Between Central Holes: 10.0mm

MWI#	SECUROS#	# OF HOLES	LENGTH (mm)
044936	004078	5	31
044016	004079	6	36

2.0mm Dynamic Compression Plate - Stainless Steel



Width: 5.0mm

Distance Between Center of Holes: 5.0mm

Distance Between Central Holes: 7.0mm

MWI#	SECUROS#	# OF HOLES	LENGTH (mm)	THICKNESS (mm)
042321	003407	4	22	1.0
042322	003408	5	27	1.0
042323	003409	6	32	1.5
042326	003461	7	37	1.5
036202	003462	8	42	1.5

2.0mm Limited Contact Dynamic Compression Plate - Stainless Steel



Width: 6.5mm

Distance Between Center of Holes: 6.0mm

MWI#	SECUROS#	# OF HOLES	LENGTH (mm)	THICKNESS (mm)
046850	003951	4	28	1.5
046870	003952	5	34	1.5
044015	003953	6	40	1.5
044017	003954	7	46	2.0
044018	003955	8	52	2.0
045052	003956	9	58	2.0
044013	003957	10	64	2.0

2.4mm Conventional Straight Plates

2.0/2.4/2.7mm Round Hole Semi-Tubular Cut-to-Length Plate - Stainless Steel



Width: 7.0mm

Thickness: 1.5mm

Distance Between Center of Holes: 6.0mm

MWI#	SECUROS#	# OF HOLES	LENGTH (mm)
042331	003475	50	300

2.4mm Dynamic Compression Plate - Stainless Steel



Width: 6.5mm

Thickness: 2.0mm

Distance Between Center of Holes: 7.0mm

Distance Between Central Holes: 10.0mm

MWI#	SECUROS#	# OF HOLES	LENGTH (mm)
049088	004978	4	31
049089	004979	5	38
049090	004980	6	45
049091	004981	7	52
049092	004982	8	59
049093	004983	9	66
049094	004984	10	73
049095	004985	11	80
049096	004986	12	87
049097	004987	13	94
049098	004988	14	101

2.4mm Limited Contact Dynamic Compression Plate - Stainless Steel



Width: 6.5mm

Thickness: 1.5mm

Distance Between Center of Holes: 8.0mm

MWI#	SECUROS#	# OF HOLES	LENGTH (mm)
044021	003627	4	36
042334	003628	5	44
042335	003629	6	52
044022	003630	7	60
044023	003631	8	68
044024	003819	9	76

Implants: 2.7mm Conventional Straight Plates

2.0/2.4/2.7mm Round Hole Semi-Tubular Cut-to-Length Plate - Stainless Steel



Width: 7.0mm

Thickness: 1.5mm

Distance Between Center of Holes: 6.0mm

MWl#	SECUROS#	# OF HOLES	LENGTH (mm)
042331	003475	50	300

2.7mm Round Hole Reconstruction Plates - Stainless Steel



Width: 8.0mm

Thickness: 2.5mm

Distance Between Center of Holes: 8.0mm

MWl#	SECUROS#	# OF HOLES	LENGTH (mm)
055042	003470	6	48
055043	003471	8	64
390150	003472	10	80
044025	003473	12	96
042317	003104	20	160

2.7mm Conventional Straight Plates

2.7mm Short Round Hole Lengthening Plates - Stainless Steel



Width: 8.0mm

Thickness: 2.0mm

Distance Between Center of Holes: 8.0mm

Distance Between Central Holes: 16.0mm

MWI#	SECUROS#	# OF HOLES	LENGTH (mm)
045170	003632	4	41
045171	003634	5	49
044932	003636	6	57
■ 372107	003638	7	65
■ 372108	003640	8	73

2.7mm Long Round Hole Lengthening Plates - Stainless Steel



Width: 8.0mm

Thickness: 2.0mm

Distance Between Center of Holes: 8.0mm

Distance Between Central Holes: 20.0mm

MWI#	SECUROS#	# OF HOLES	LENGTH (mm)
048197	003633	4	45
048198	003635	5	53
044933	003637	6	61
048216	003639	7	69
■ 276574	003641	8	77

■ special order item

2.7mm Conventional Straight Plates

2.7mm Dynamic Compression Plates - Stainless Steel



Width: 8.0mm

Distance Between Center of Holes: 8.0mm

Distance Between Central Holes: 12.0mm

MWl#	SECUROS#	# OF HOLES	LENGTH (mm)	THICKNESS (mm)
029190	001648	4	36	2.0
029191	001649	5	44	2.0
029192	001650	6	52	2.0
029193	001651	7	60	2.5
029194	001652	8	68	2.5
042218	001653	9	76	2.5
042219	001654	10	84	2.5
042276	002450	11	92	2.5
042220	001655	12	100	2.5

2.7mm Limited Contact Dynamic Compression Plates - Stainless Steel



Width: 8.0mm

Thickness: 2.5mm

Distance Between Center of Holes: 9.0mm

MWl#	SECUROS#	# OF HOLES	LENGTH (mm)
042212	001639	4	42
042213	001640	5	51
029183	001641	6	60
029184	001642	7	69
029185	001643	8	78
042214	001644	9	87
042215	001645	10	96
042216	001646	11	105
042217	001647	12	114
042410	003906	14	132

3.5mm Conventional Straight Plates

3.5mm Round Hole Reconstruction Plates - Stainless Steel



Width: 10.0mm

Thickness: 2.8mm

Distance Between Center of Holes: 12.0mm

MWI#	SECUROS#	# OF HOLES	LENGTH (mm)
048190	003477	4	46
048158	003105	5	58
048159	003106	6	70
045623	003107	7	82
045157	003108	8	94
048160	003109	9	106
048161	003110	10	118
■ 372109	003478	11	130
045158	003111	12	142
048191	003479	13	154
045624	003112	14	166
048192	003485	15	178
055032	002701	16	190
055033	002702	18	214
044038	002703	20	238
045141	002704	22	262

3.5mm Curved Round Hole Reconstruction Plates - Stainless Steel



Width: 10.0mm

Thickness: 3.6mm

Distance Between Center of Holes: 12.0mm

MWI#	SECUROS#	# OF HOLES	OVERALL SPAN (mm)
048569	002696	6	70
048570	002697	8	94
048571	002698	10	118
046260	002699	12	142
048156	003100	14	166
048157	003101	16	190
■ 372111	003102	18	214

■ special order item

3.5mm Conventional Straight Plates

3.5mm Narrow Short Round Hole Lengthening Plates - Stainless Steel



Width: 10.0mm

Thickness: 3.2mm

Distance Between Center of Holes: 12.0mm

Distance Between Central Holes: 40.0mm

MWI#	SECUROS#	# OF HOLES	LENGTH (mm)
048103	000378	4	73
048104	000379	5	85
045400	000380	6	97
045401	000381	7	109
045548	000382	8	121
045565	000383	9	133
045086	000384	10	145

3.5mm Narrow Long Round Hole Lengthening Plates - Stainless Steel



Width: 10.0mm

Thickness: 3.2mm

Distance Between Center of Holes: 12.0mm

Distance Between Central Holes: 52.0mm

MWI#	SECUROS#	# OF HOLES	LENGTH (mm)
048228	004082	4	85
045187	004083	5	97
048229	004084	6	109
044937	004085	7	121
045166	003588	8	133
048230	004087	9	145
■ 372112	004088	10	157

3.5mm Conventional Straight Plates

3.5mm Broad Short Round Hole Lengthening Plates - Stainless Steel



Width: 12.0mm

Thickness: 4.0mm

Distance Between Center of Holes: 12.0mm

Distance Between Central Holes: 52.0mm

MWI#	SECUROS#	# OF HOLES	LENGTH (mm)
045481	003493	4	86
048195	003494	5	98
048196	003495	6	110
045490	003496	7	122
045632	003497	8	134
044931	003498	9	146
■ 372113	003499	10	158

3.5mm Broad Long Round Hole Lengthening Plates - Stainless Steel

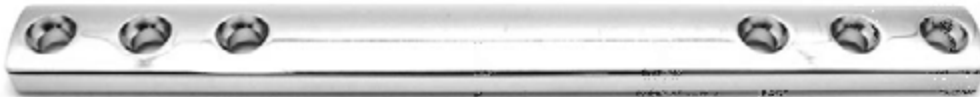

Width: 12.0mm

Thickness: 4.0mm

Distance Between Center of Holes: 12.0mm

Distance Between Central Holes: 64.0mm

MWI#	SECUROS#	# OF HOLES	LENGTH (mm)
■ 372114	003486	4	98
048193	003487	5	110
045164	003488	6	122
045479	003489	7	134
045631	003490	8	146
045480	003491	9	158
048194	003492	10	170

■ special order item

3.5mm Conventional Straight Plates

3.5mm Narrow Dynamic Compression Plates - Stainless Steel



Width: 10.0mm

Thickness: 3.2mm

Distance Between Center of Holes: 12.0mm

Distance Between Central Holes: 16.0mm

MWI#	SECUROS#	# OF HOLES	LENGTH (mm)
042260	002111	4	49
042261	002112	5	61
029228	002113	6	73
029229	002114	7	85
029230	002115	8	97
029231	002119	9	109
029232	002117	10	121
042263	002118	11	133
042262	002116	12	145
042446	004413	13	157
042277	002452	14	169
044036	003555	16	193
044037	003556	18	217

3.5mm Broad Dynamic Compression Plates - Stainless Steel



Width: 12.0mm

Thickness: 4.0mm

Distance Between Center of Holes: 12.0mm

Distance Between Central Holes: 16.0mm

MWI#	SECUROS#	# OF HOLES	LENGTH (mm)
029235	002120	7	85
029236	002121	8	97
029237	002122	9	109
029238	002123	10	121
029239	002124	11	133
042264	002125	12	145
029241	002126	13	157
042265	002127	14	169
029243	002128	16	193
029244	002129	18	217
029245	002130	20	241
029246	002131	22	265

3.5mm Conventional Straight Plates

3.5mm Narrow Limited Contact Dynamic Compression Plates - Stainless Steel



Width: 10.0mm

Thickness: 3.2mm

Distance Between Center of Holes: 13.0mm

MWI#	SECUROS#	# OF HOLES	LENGTH (mm)
042254	002102	4	51
042255	002103	5	64
029219	002104	6	77
029220	002105	7	90
029221	002106	8	103
042256	002107	9	116
042257	002108	10	129
042258	002109	11	142
042259	002110	12	155
052745	005503	13	168
045545	003782	14	181
044035	003781	16	207
049479	003780	18	233
055132	005316	20	259

3.5mm Broad Limited Contact Dynamic Compression Plates - Stainless Steel



Width: 14.5mm

Thickness: 4.5mm

Distance Between Center of Holes: 13.0mm

MWI#	SECUROS#	# OF HOLES	LENGTH (mm)
045172	003643	7	90
046920	003644	8	103
044302	003645	9	116
046790	003646	10	129
048495	003647	11	142
044030	003648	12	155
044032	003649	13	168
044033	003650	14	181
045173	003652	16	207
052746	005504	18	233

4.5mm Conventional Straight Plates

4.5mm Narrow Dynamic Compression Plates - Stainless Steel



Width: 12.0mm

Thickness: 4.0mm

Distance Between Center of Holes: 16.0mm

Distance Between Central Holes: 25.0mm

MWI#	SECUIROS#	# OF HOLES	LENGTH (mm)
029247	002132	2	39
029248	002133	3	55
029249	002134	4	71
029250	002135	5	87
029251	002136	6	103
042266	002137	7	119
029253	002138	8	135
029254	002139	9	151
029255	002140	10	167
029256	002141	11	183
029257	002142	12	199
029258	002143	13	215
029259	002144	14	231
029260	002145	15	247
048551	002146	16	263
048552	002147	18	295
048553	002148	20	327
029265	002150	24	391

4.5mm Broad Dynamic Compression Plates - Stainless Steel



Width: 16.5mm

Thickness: 4.5mm

Distance Between Center of Holes: 16.0mm

Distance Between Central Holes: 25.0mm

MWI#	SECUIROS#	# OF HOLES	LENGTH (mm)
029266	002151	6	103
048554	002152	7	119
029268	002153	8	135
029269	002154	9	151
029270	002155	10	167
029271	002156	12	199
029272	002157	14	231
029273	002158	16	263
029274	002159	18	295
048555	002160	20	327
029277	001522	22	359
029278	001523	24	391
029279	001524	26	423

Conventional T-Plates

1.5/2.0mm T-Plates - Stainless Steel



MWI#	SECUROS#	# HOLES HEAD	# HOLES SHAFT	OVERALL LENGTH (mm)	HEAD WIDTH (mm)	SHAFT WIDTH (mm)	THICKNESS (mm)
036066	002508	2	4	34.5	9	5	1.5
042415	003969	2	5	41.5	9	5	1.5
042414	003968	2	6	48.5	9	5	1.5
044003	003967	2	7	55.5	9	5	1.5
042408	003826	2	8	62.5	9	5	1.5

2.0mm T-Plates - Stainless Steel



001823



002311



006082

MWI#	SECUROS#	# HOLES HEAD	# HOLES SHAFT	OVERALL LENGTH (mm)	HEAD WIDTH (mm)	SHAFT WIDTH (mm)	THICKNESS (mm)
044019	001823	2	2	18	10.5	5	1.0
045129	002311	3	3	26	10	5	1.5
042054	000640	3	8	45	15	5	1.2
045528	006081	3	9	50	15	5	1.2
044900	006082	4	9	50	20	5	1.2

2.7mm T-Plates - Stainless Steel



006083



002312

MWI#	SECUROS#	# HOLES HEAD	# HOLES SHAFT	OVERALL LENGTH (mm)	HEAD WIDTH (mm)	SHAFT WIDTH (mm)	THICKNESS (mm)
044960	006083	2	3	32	13	7	1.2
045615	002312	3	3	39	16	8	2.0

Conventional T-Plates

2.7/3.5mm T-Plates - Stainless Steel



MWI#	SECUROS#	# HOLES HEAD	# HOLES SHAFT	OVERALL LENGTH (mm)	HEAD WIDTH (mm)	SHAFT WIDTH (mm)	THICKNESS (mm)
042297	002612	2	5	65	18	9.5	2.0
045532	000641	2	7	85	18	9.5	2.0
044306	000642	2	9	105	18	9.5	2.0

3.5mm T-Plates - Stainless Steel



MWI#	SECUROS#	# HOLES HEAD	# HOLES SHAFT	OVERALL LENGTH (mm)	HEAD WIDTH (mm)	SHAFT WIDTH (mm)	THICKNESS (mm)
055094	002313	3	3	55	22	10	3.0
055095	002314	3	4	80	24	12	3.0

3.5mm Right Angle T-Plates - Stainless Steel

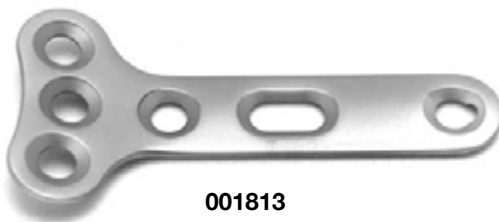

001813

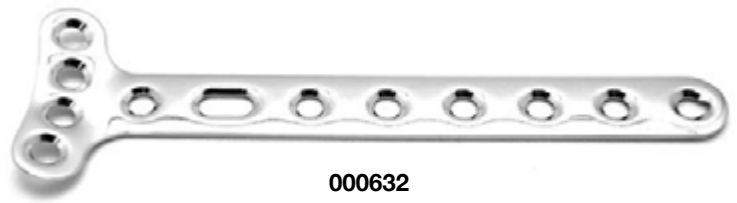

000632

MWI#	SECUROS#	# HOLES HEAD	# HOLES SHAFT	OVERALL LENGTH (mm)	HEAD WIDTH (mm)	SHAFT WIDTH (mm)	THICKNESS (mm)
044303	001813	3	3	50	24	10	1.2
044304	001815	3	5	67	24	10	1.2
■ 372176	001814	4	4	57	31	10	1.2
■ 372177	001816	4	6	79	31	11	1.2
045571	000632	4	8	100	31	11	1.2

■ special order item

Conventional T-Plates

4.5mm T-Plates - Stainless Steel



MWI#	SECUIROS#	# HOLES HEAD	# HOLES SHAFT	OVERALL LENGTH (mm)	HEAD WIDTH (mm)	SHAFT WIDTH (mm)	THICKNESS (mm)
045124	001811	2	5	100	33	17	2.0
■ 372178	001812	2	6	115	33	17	2.0



■ special order item

Conventional L-Plates

2.0mm L-Plates - Stainless Steel



000636, 000637

MWI#	SECUROS#	DIRECTION	# HOLES HEAD	# HOLES SHAFT	OVERALL LENGTH (mm)	HEAD WIDTH (mm)	SHAFT WIDTH (mm)	THICKNESS (mm)
045012	000636	Left	2	2	18	11	5	1.0
045568	000637	Right	2	2	18	11	5	1.0

2.7mm L-Plates - Stainless Steel

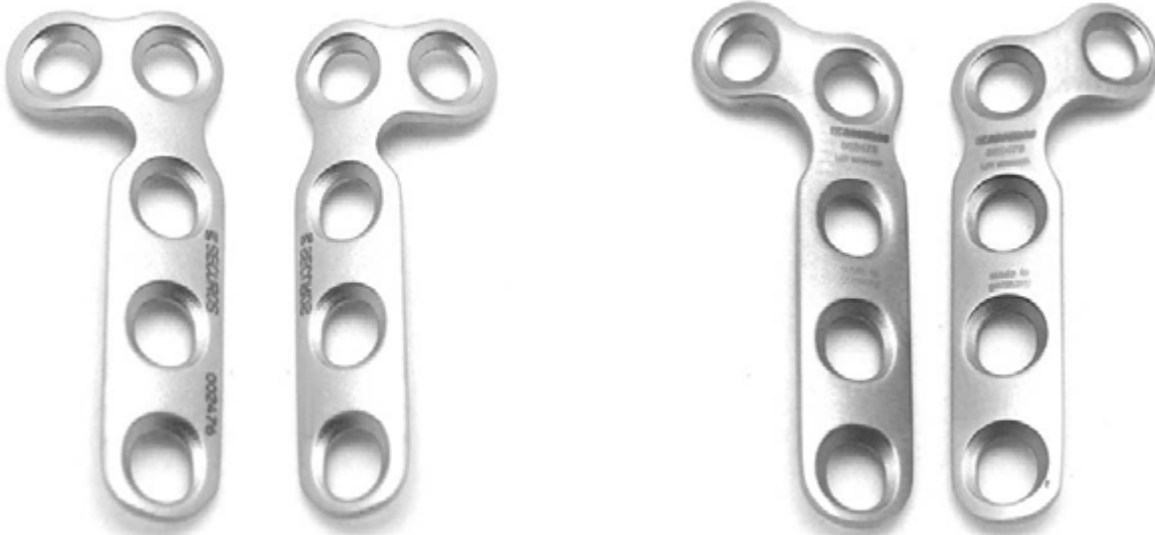

002476, 002477

002478, 002479

MWI#	SECUROS#	DIRECTION	# HOLES HEAD	# HOLES SHAFT	OVERALL LENGTH (mm)	HEAD WIDTH (mm)	SHAFT WIDTH (mm)	THICKNESS (mm)
055096	002476	Left	2	3	32	13	7	1.2
048567	002477	Right	2	3	32	13	7	1.2
048568	002478	Left Oblique	2	3	34	13	7	1.2
045134	002479	Right Oblique	2	3	34	13	7	1.2

Conventional Acetabular Plates

2.0mm Acetabular Plates - Stainless Steel



MWI#	SECUROS#	# OF HOLES	OVERALL SPAN (mm)	WIDTH (mm)	THICKNESS (mm)
045535	002515	4	20	4	1.2
045534	002514	4	24	5	1.2

2.7mm Acetabular Plates - Stainless Steel



MWI#	SECUROS#	# OF HOLES	OVERALL SPAN (mm)	WIDTH (mm)	THICKNESS (mm)
031202	002516	6	32	6	1.5
044616	002520	6	36	6.5	1.2

3.5mm Acetabular Plates - Stainless Steel



MWI#	SECUROS#	# OF HOLES	OVERALL SPAN (mm)	WIDTH (mm)	THICKNESS (mm)
045586	002518	6	42	7	2.2
■ 276479	002519	6	48	8	2.6

■ special order item

Conventional Distal Femur Osteotomy Plates

2.0mm Distal Femur Osteotomy Plates - Stainless Steel

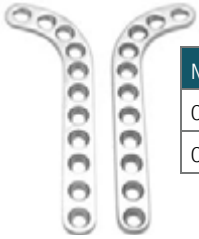

MWI#	SECUROS#	DIRECTION	OVERALL SPAN (mm)	HEAD WIDTH (mm)	SHAFT WIDTH (mm)	THICKNESS (mm)
036192	004071	Left	50	17	5.5	1.5
036203	004070	Right	50	17	5.5	1.5

2.7mm Distal Femur Osteotomy Plates - Stainless Steel

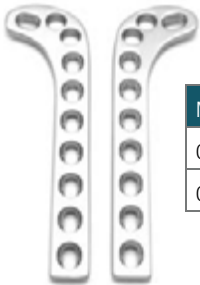

MWI#	SECUROS#	DIRECTION	OVERALL SPAN (mm)	HEAD WIDTH (mm)	SHAFT WIDTH (mm)	THICKNESS (mm)
042302	002694	Left	70	20.5	8	2.5
042303	002695	Right	70	20.5	8	2.5

3.5mm Distal Femur Osteotomy Plates - Stainless Steel

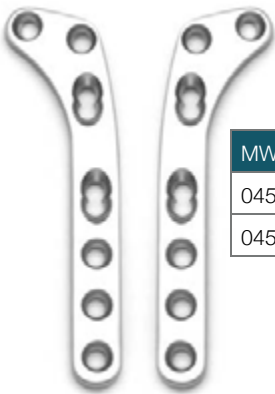

MWI#	SECUROS#	DIRECTION	OVERALL SPAN (mm)	HEAD WIDTH (mm)	SHAFT WIDTH (mm)	THICKNESS (mm)
045536	002692	Left	84	24	10.5	4.0
045555	002693	Right	84	24	10.5	4.0

3.5mm Broad Distal Femur Osteotomy Plates - Stainless Steel

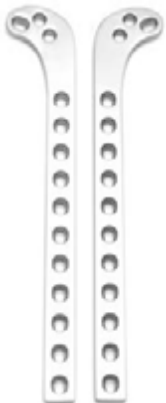

MWI#	SECUROS#	DIRECTION	OVERALL SPAN (mm)	HEAD WIDTH (mm)	SHAFT WIDTH (mm)	THICKNESS (mm)
045562	004073	Left	171.5	30.5	12	4.5
045185	004072	Right	171.5	30.5	12	4.5

1.5mm Cortical Screws

1.5mm Cortical Screw, Self-Tapping, Cruciform Recess - Stainless Steel



Diameter of Thread: 1.5mm

Diameter of Head: 3.0mm

Drill Bit for Threaded Hole: 1.1mm

Drill Bit for Gliding Hole: 1.5mm

For Use With:

1.5/2.0mm Cruciform Screwdriver

Smooth Washer for 1.5mm, 2.0mm Screws

MWI#	SECUROS#	LENGTH (mm)
042141	100026	6
042125	100000	7
042126	100001	8
042127	100002	9
042128	100003	10
042142	100027	11
042129	100004	12
049131	100028	13
042130	100005	14
042131	100006	16
044000	100007	18
044001	100008	20
048127	100029	22
048128	100030	24

1.5mm Cortical Screw, Non Self-Tapping, Cruciform Recess - Stainless Steel



Diameter of Thread: 1.5mm

Diameter of Head: 3.0mm

Drill Bit for Threaded Hole: 1.1mm

Drill Bit for Gliding Hole: 1.5mm

For Use With:

1.5/2.0mm Cruciform Screwdriver

1.5mm Cortical Tap

Smooth Washer for 1.5mm, 2.0mm Screws

MWI#	SECUROS#	LENGTH (mm)
390100	005109	6
390101	005110	7
390102	005111	8
390103	005112	9
390104	005113	10
390105	005114	11
390106	005115	12
390107	005116	13
390108	005117	14
390109	005118	16
390110	005119	18
■ 372115	005120	20
■ 372116	005121	22
■ 372117	005122	24

■ special order item

1.5mm Cortical Screws

1.5mm Cortical Screw, Self-Tapping, Hexagonal Recess - Stainless Steel



Diameter of Thread: 1.5mm

Diameter of Head: 3.0mm

Drill Bit for Threaded Hole: 1.1mm

Drill Bit for Gliding Hole: 1.5mm

For Use With:

1.5mm Hexagonal Screwdriver

Smooth Washer for 1.5mm, 2.0mm Screws

MWI#	SECUROS#	LENGTH (mm)
029121	001835	6
029122	001836	7
029123	001837	8
029124	001839	9
029125	001840	10
031110	002529	11
029126	001841	12
031111	002530	13
029127	001842	14
029128	001843	16
031112	001844	18
031113	001845	20
031114	001846	22
031115	001847	24

1.5mm Cortical Screw, Non Self-Tapping, Hexagonal Recess - Stainless Steel



Diameter of Thread: 1.5mm

Diameter of Head: 3.0mm

Drill Bit for Threaded Hole: 1.1mm

Drill Bit for Gliding Hole: 1.5mm

For Use With:

1.5mm Hexagonal Screwdriver

1.5mm Cortical Tap

Smooth Washer for 1.5mm, 2.0mm Screws



MWI#	SECUROS#	LENGTH (mm)
049359	400040	6
049473	400042	7
■ 372185	400044	8
■ 372186	400046	9
■ 372187	400048	10
049380	400050	11
■ 372191	400052	12
049471	400237	13
■ 372188	400054	14
049383	400056	16
049384	400058	18
049385	400060	20

■ special order item

2.0mm Cortical Screws

2.0mm Cortical Screw, Self-Tapping, Cruciform Recess - Stainless Steel



Diameter of Thread: 2.0mm

Diameter of Head: 4.0mm

Drill Bit for Threaded Hole: 1.5mm

Drill Bit for Gliding Hole: 2.0mm

For Use With:

1.5/2.0mm Cruciform Screwdriver

Smooth Washer for 1.5mm, 2.0mm Screws

Spiked Washer for 2.0mm, 2.4mm Screws

MWI#	SECUROS#	LENGTH (mm)
042132	100009	6
042133	100010	8
042134	100011	10
042140	100022	12
■ 370036	100048	13
042135	100012	14
042136	100013	16
042137	100014	18
042138	100016	20
044009	100017	22
042139	100018	24
055060	100019	26
044010	100020	28
049129	100021	30
045211	100023	32
045214	100024	34
049130	100025	36
■ 370037	100049	38
■ 370038	100050	40

2.0mm Cortical Screw, Non Self-Tapping, Cruciform Recess - Stainless Steel



Diameter of Thread: 2.0mm

Diameter of Head: 4.0mm

Drill Bit for Threaded Hole: 1.5mm

Drill Bit for Gliding Hole: 2.0mm

For Use With:

1.5/2.0mm Cruciform Screwdriver

2.0mm Cortical Tap

Smooth Washer for 1.5mm, 2.0mm Screws

Spiked Washer for 2.0mm, 2.4mm Screws

MWI#	SECUROS#	LENGTH (mm)
390111	100052	8
390112	100053	10
390113	100054	12
390114	100055	13
390115	100056	14
390116	100057	16
390117	100058	18
■ 372118	100059	20
■ 372119	100060	22
■ 372120	100061	24
■ 372121	100062	26
■ 372122	100063	28
■ 372123	100064	30
■ 372124	100065	32
■ 372125	100066	34
■ 372126	100067	36
■ 372127	100068	38
■ 372129	100069	40

■ special order item

2.0mm Cortical Screws

2.0mm Cortical Screw, Self-Tapping, Hexagonal Recess - Stainless Steel



Diameter of Thread: 2.0mm

Diameter of Head: 4.0mm

Drill Bit for Threaded Hole: 1.5mm

Drill Bit for Gliding Hole: 2.0mm

For Use With:

1.5/2.0mm Hexagonal Screwdriver

Smooth Washer for 1.5mm, 2.0mm Screws

Spiked Washer for 2.0mm, 2.4mm Screws

MWI#	SECUROS#	LENGTH (mm)
029135	001853	6
029136	001854	8
029137	001855	10
029138	001856	12
■ 370039	005123	13
029139	001857	14
029140	001858	16
029141	001859	18
029142	001860	20
029143	001861	22
029144	001862	24
029145	001863	26
029146	001864	28
029147	001865	30
029148	001866	32
■ 370040	005124	34
■ 370041	005125	36
■ 370042	005126	38
■ 370043	005127	40

2.0mm Cortical Screw, Non Self-Tapping, Hexagonal Recess - Stainless Steel



Diameter of Thread: 2.0mm

Diameter of Head: 4.0mm

Drill Bit for Threaded Hole: 1.5mm

Drill Bit for Gliding Hole: 2.0mm

For Use With:

1.5/2.0mm Hexagonal Screwdriver

2.0mm Cortical Tap

Smooth Washer for 1.5mm, 2.0mm Screws

Spiked Washer for 2.0mm, 2.4mm Screws

MWI#	SECUROS#	LENGTH (mm)
■ 372189	400062	6
■ 372190	400064	8
049472	400066	10
049388	400068	12
049365	400070	14
049366	400072	16
049367	400074	18
049393	400076	20
049394	400078	22
049395	400080	24
049396	400264	26
049398	400265	28
049400	400266	30
049406	400267	32



■ special order item

2.4mm Cortical Screws

2.4mm Cortical Screw, Self-Tapping, Cruciform Recess - Stainless Steel



Diameter of Thread: 2.4mm

Diameter of Head: 4.0mm

Drill Bit for Threaded Hole: 1.8mm

Drill Bit for Gliding Hole: 2.4mm

For Use With:

1.5/2.0/2.4mm Cruciform Screwdriver

Smooth Washer for 2.4mm, 2.7mm Screws

Spiked Washer for 2.4mm, 2.7mm Screws

MWI#	SECUROS#	LENGTH (mm)
047227	100095	6
047228	100096	7
047229	100097	8
047230	100098	9
047231	100099	10
047232	100100	11
047233	100101	12
047234	100102	13
047235	100103	14
047236	100104	16
047237	100105	18
047238	100106	20
047239	100107	22
047240	100108	24
047241	100109	26
047242	100110	28
047243	100111	30
047244	100112	32
047245	100113	34
047246	100114	36
047247	100115	38
047248	100116	40

2.4mm Cortical Screw, Self-Tapping, Hexagonal Recess - Stainless Steel



Diameter of Thread: 2.4mm

Diameter of Head: 4.0mm

Drill Bit for Threaded Hole: 1.8mm

Drill Bit for Gliding Hole: 2.4mm

For Use With:

2.4mm Hexagonal Screwdriver

Smooth Washer for 2.4mm, 2.7mm Screws

Spiked Washer for 2.4mm, 2.7mm Screws

MWI#	SECUROS#	LENGTH (mm)
■ 370020	005133	7
042299	002614	8
■ 370021	005134	9
030982	001027	10
■ 370022	005135	11
030983	001028	12
■ 370023	005136	13
030984	001029	14
030985	001030	16
030986	001031	18
030987	001032	20
030980	001033	22
030988	001034	24
030989	001035	26
030981	001036	28
030990	001037	30
030991	001038	32
030992	001039	34
030993	001040	36
030994	001041	38
030995	001042	40

■ special order item

2.7mm Cortical Screws

2.7mm Cortical Screw, Self-Tapping, Hexagonal Recess - Stainless Steel



Diameter of Thread: 2.7mm

Diameter of Head: 5.0mm

Drill Bit for Threaded Hole: 2.0mm

Drill Bit for Gliding Hole: 2.7mm

For Use With:

2.7/3.5/4.0mm Hexagonal Screwdriver

Smooth Washer for 2.4mm, 2.7mm Screws

Smooth Washer for 2.7mm, 3.5mm Screws

Spiked Washer for 2.4mm, 2.7mm Screws

Spiked Washer for 2.7mm, 3.5mm Screws

MWI#	SECUROS#	LENGTH (mm)
031116	002540	6
029166	001878	8
029167	001879	10
029168	001880	12
029169	001881	14
029170	001882	16
029171	001883	18
029172	001630	20
029173	001631	22
029174	001632	24
029175	001633	26
029176	001634	28
029177	001635	30

MWI#	SECUROS#	LENGTH (mm)
029178	001636	32
031117	002549	34
031152	002550	36
035974	003554	38
042294	002551	40
048237	004450	42
048238	004451	44
042295	002552	45
048239	004452	46
■ 370044	004453	48
042296	002553	50
■ 370045	005143	55

2.7mm Cortical Screw, Non Self-Tapping, Hexagonal Recess - Stainless Steel



Diameter of Thread: 2.7mm

Diameter of Head: 5.0mm

Drill Bit for Threaded Hole: 2.0mm

Drill Bit for Gliding Hole: 2.7mm

For Use With:

2.7/3.5/4.0mm Hexagonal Screwdriver

2.7mm Cortical Tap

Smooth Washer for 2.4mm, 2.7mm Screws

Smooth Washer for 2.7mm, 3.5mm Screws

Spiked Washer for 2.4mm, 2.7mm Screws

Spiked Washer for 2.7mm, 3.5mm Screws

MWI#	SECUROS#	LENGTH (mm)
046145	004940	6
046146	004941	8
046147	004942	10
046148	004943	12
046149	004944	14
046150	004945	16
046151	004946	18
046152	004947	20
046153	004948	22
046154	004949	24
046155	004950	26
046156	004951	28
046157	004952	30

MWI#	SECUROS#	LENGTH (mm)
046158	004953	32
046159	004954	34
046160	004955	36
046161	004956	38
046162	004957	40
■ 372129	005144	42
■ 372134	005145	44
■ 372135	005150	45
■ 372136	005146	46
■ 372137	005147	48
■ 372138	005148	50
■ 372139	005149	55

■ special order item

3.5mm Cortical Screws

3.5mm Cortical Screw, Self-Tapping, Hexagonal Recess - Stainless Steel



Diameter of Thread: 3.5mm

Diameter of Head: 6.0mm

Drill Bit for Threaded Hole: 2.5mm

Drill Bit for Gliding Hole: 3.5mm

For Use With:

2.7/3.5/4.0mm Hexagonal Screwdriver

Smooth Washer for 2.7mm, 3.5mm Screws

Spiked Washer for 2.7mm, 3.5mm Screws

Spiked Washer for 3.5mm, 4.0mm Screws

MWI#	SECUROS#	LENGTH (mm)
029200	001885	10
029201	001886	12
029202	001887	14
029203	001888	16
029204	001889	18
029205	001890	20
029207	001891	22
029208	001892	24
029209	001893	26
029210	001894	28
029211	001895	30
029212	001896	32
029213	001897	34

MWI#	SECUROS#	LENGTH (mm)
029214	001898	36
029215	001899	38
029216	002101	40
042451	004470	42
042452	004471	44
031119	002593	45
036060	004472	46
042453	004473	48
031120	002592	50
031121	002594	55
036197	002595	60
042382	006068	65
042384	006069	70

3.5mm Cortical Screw, Non Self-Tapping, Hexagonal Recess - Stainless Steel



Diameter of Thread: 3.5mm

Diameter of Head: 6.0mm

Drill Bit for Threaded Hole: 2.5mm

Drill Bit for Gliding Hole: 3.5mm

For Use With:

2.7/3.5/4.0mm Hexagonal Screwdriver

3.5mm Cortical Tap

Smooth Washer for 2.7mm, 3.5mm Screws

Spiked Washer for 2.7mm, 3.5mm Screws

Spiked Washer for 3.5mm, 4.0mm Screws

MWI#	SECUROS#	LENGTH (mm)
046163	004958	10
046164	004959	12
046165	004960	14
046166	004961	16
046167	004962	18
046168	004963	20
046169	004964	22
046170	004965	24
046171	004966	26
046172	004967	28
046173	004968	30
046174	004969	32
046175	004970	34

MWI#	SECUROS#	LENGTH (mm)
046176	004971	36
046177	004972	38
046178	004973	40
046184	004989	42
055124	005163	44
046179	004974	45
055125	005164	46
■ 372141	005165	48
046180	004975	50
046181	004976	55
046182	004977	60
■ 372142	005166	65
■ 372143	005167	70

■ special order item

4.0mm Cancellous Screws

4.0mm Cancellous Screw, Fully Threaded, Hexagonal Recess - Stainless Steel



Diameter of Thread: 4.0mm

Diameter of Head: 6.0mm

Drill Bit for Threaded Hole: 2.0mm

For Use With:

2.7/3.5/4.0mm Hexagonal Screwdriver

4.0mm Cancellous Tap

Smooth Washer for 4.0mm, 4.5mm Screws

Spiked Washer for 3.5mm, 4.0mm Screws

MWI#	SECUROS#	LENGTH (mm)
042043	000441	10
048114	000442	12
048500	000443	14
■ 372046	000444	16
■ 372047	000445	18
048501	000446	20
■ 372048	000447	22
046112	000448	24
■ 372049	000449	26
■ 372172	000450	28
■ 372173	000451	30
042045	000452	32
■ 372050	000453	34

MWI#	SECUROS#	LENGTH (mm)
■ 372051	000454	36
■ 372052	000455	38
■ 372174	000456	40
■ 372053	000413	42
■ 372054	000414	44
046113	000474	45
042041	000439	46
■ 372055	000440	48
■ 372056	000458	50
■ 372057	000459	55
048502	000460	60
■ 372059	005171	65
■ 372059	005172	70

4.0mm Cancellous Screw, Fully Threaded, "Fat Neck", Hexagonal Recess - Stainless Steel



Diameter of Thread: 4.0mm

Diameter of Head: 6.0mm

Drill Bit for Threaded Hole: 2.0mm

For Use With:

2.7/3.5/4.0mm Hexagonal Screwdriver

4.0mm Cancellous Tap

Smooth Washer for 4.0mm, 4.5mm Screws

Spiked Washer for 3.5mm, 4.0mm Screws

MWI#	SECUROS#	LENGTH (mm)
029415	001579	10
029416	001580	12
029417	001581	14
029418	001582	16
029419	001583	18
029420	001584	20
029421	001585	22
029422	001586	24
029423	001587	26
029424	001588	28
029425	001589	30
029426	001590	32
029427	001591	34

MWI#	SECUROS#	LENGTH (mm)
029428	001592	36
029429	001593	38
029430	001594	40
035931	004006	42
035975	004007	44
029431	001595	45
045196	004428	46
045197	004429	48
029432	001596	50
029433	001597	55
029434	001598	60

■ special order item

4.0mm Cancellous Screws

4.0mm Cancellous Screw, Partially Threaded, Hexagonal Recess - Stainless Steel



Diameter of Thread: 4.0mm

Diameter of Head: 6.0mm

Drill Bit for Threaded Hole: 2.0mm

For Use with:

2.7/3.5/4.0mm Hexagonal Screwdriver

4.0mm Cancellous Tap

Smooth Washer for 4.0mm, 4.5mm Screws

Spiked Washer for 3.5mm, 4.0mm Screws

MWI#	SECUROS#	LENGTH (mm)	MWI#	SECUROS#	LENGTH (mm)
029398	001562	10	■ 372146	005175	36
029399	001563	12	■ 372147	005176	38
029400	001564	14	029410	001574	40
029401	001565	16	■ 372148	005177	42
029402	001566	18	■ 372149	005178	44
042206	001567	20	029411	001575	45
029404	001568	22	■ 372150	005179	46
029405	001569	24	■ 372151	005180	48
042207	001570	26	029412	001576	50
042208	001571	28	029413	001577	55
042209	001572	30	029414	001578	60
■ 372144	005173	32	■ 372152	005181	65
■ 372145	005174	34	■ 372153	005182	70



■ special order item

4.5mm Cortical Screws

4.5mm Cortical Screw, Self-Tapping, Hexagonal Recess - Stainless Steel



Diameter of Thread: 4.5mm

Diameter of Head: 8.0mm

Drill Bit for Threaded Hole: 3.2mm

Drill Bit for Gliding Hole: 4.5mm

For Use With:

4.5/5.5/6.5mm Hexagonal Screwdriver

Smooth Washer for 4.0mm, 4.5mm Screws

Smooth Washer for 4.5mm, 5.5mm, 6.5mm Screws

Spiked Washer for 4.5mm, 5.5mm, 6.5mm Screws

MWI#	SECUROS#	LENGTH (mm)
042099	001526	14
042200	001527	16
029283	001528	18
029284	001529	20
029285	001530	22
029286	001531	24
029287	001532	26
029288	001533	28
029289	001534	30
029290	001535	32
029291	001536	34
029292	001537	36
029293	001538	38
029294	001539	40
029295	001540	42
042202	001541	44
029297	001542	46
042203	001543	48
042204	001544	50

MWI#	SECUROS#	LENGTH (mm)
042205	001545	52
029384	001546	54
044901	000874	55
029385	001547	56
029386	001548	58
029387	001549	60
055049	003808	62
044934	004001	64
048178	003809	66
048232	004002	68
029389	001551	70
029390	001552	75
029391	001553	80
029392	001556	85
029393	001557	90
029394	001558	95
029395	001559	100

4.5mm Cortical Screw, Non Self-Tapping, Hexagonal Recess - Stainless Steel



Diameter of Thread: 4.5mm

Diameter of Head: 8.0mm

Drill Bit for Threaded Hole: 3.2mm

Drill Bit for Gliding Hole: 4.5mm

For Use With:

4.5/5.5/6.5mm Hexagonal Screwdriver

4.5mm Cortical Tap

Smooth Washer for 4.0mm, 4.5mm Screws

Smooth Washer for 4.5mm, 5.5mm, 6.5mm Screws

Spiked Washer for 4.5mm, 5.5mm, 6.5mm Screws

MWI#	SECUROS#	LENGTH (mm)
049433	005220	14
049434	005221	16
049436	005222	18
049437	005223	20
049438	005224	22
049439	005225	24
049442	005226	26
049443	005227	28
049444	005228	30
049445	005229	32
049446	005230	34
049447	005231	36
049448	005232	38
049449	005233	40
049450	005234	42
049451	005235	44
049452	005236	45
■ 372154	005237	46
049453	005238	48

MWI#	SECUROS#	LENGTH (mm)
049454	005239	50
■ 372155	005240	52
■ 372156	005241	54
■ 372157	005242	55
■ 372158	005243	56
■ 372159	005244	58
■ 372160	005245	60
■ 372161	005246	62
■ 372162	005247	64
■ 372164	005248	66
■ 370052	005249	68
■ 370053	005250	70
■ 370054	005251	75
■ 370055	005252	80
■ 370056	005253	85
■ 370057	005254	90
■ 370058	005255	95
■ 370059	005256	100

■ special order item

5.5mm Cortical Screws

5.5mm Cortical Screw, Hexagonal Recess - Stainless Steel



Diameter of Thread: 5.5mm

Diameter of Head: 8.0mm

Drill Bit for Threaded Hole: 4.0mm

Drill Bit for Gliding Hole: 5.5mm

For Use With:

4.5/5.5/6.5mm Hexagonal Screwdriver

5.5mm Cortical Tap

Smooth Washer for 4.5mm, 5.5mm, 6.5mm Screws

Spiked Washer for 4.5mm, 5.5mm, 6.5mm Screws

MWI#	SECUROS#	LENGTH (mm)	MWI#	SECUROS#	LENGTH (mm)
■ 370060	005257	24	■ 370071	005269	48
■ 370061	005258	26	■ 370072	005270	50
■ 370062	005259	28	049456	005271	52
■ 370063	005260	30	■ 370073	005272	54
049455	005261	32	■ 370074	005273	56
■ 370064	005262	34	■ 370075	005274	58
■ 370065	005263	36	■ 370076	005275	60
■ 370066	005264	38	■ 370077	005276	65
■ 370067	005265	40	■ 370078	005277	70
■ 370068	005266	42	■ 370079	005278	80
■ 370069	005267	44	049457	005279	90
■ 370070	005268	46	048394	005280	100

6.5mm Cancellous Screws

6.5mm Cancellous Screw, Fully Threaded, Hexagonal Recess - Stainless Steel



Diameter of Thread: 6.5mm

Diameter of Head: 8.0mm

Drill Bit for Threaded Hole: 3.2mm

Drill Bit for Gliding Hole: 4.5mm

For Use With:

4.5/5.5/6.5mm Hexagonal Screwdriver

6.5mm Cancellous Tap

Smooth Washer for 4.5mm, 5.5mm, 6.5mm Screws

Spiked Washer for 4.5mm, 5.5mm, 6.5mm Screws

MWI#	SECUROS#	LENGTH (mm)
■ 370080	004144	25
045149	002904	30
045526	002905	35
044610	002906	40
■ 370081	004145	45
045015	000864	50
044611	000865	55
045296	000866	60
■ 370082	004146	65
■ 370541	000867	70
048509	000868	75
■ 370083	004147	80
■ 370084	004148	85
■ 370085	004149	90
■ 370086	004150	95
■ 370087	004151	100

■ special order item

6.5mm Cancellous Screws

6.5mm Cancellous Screw, 16mm Thread Length, Hexagonal Recess - Stainless Steel



Diameter of Thread: 6.5mm

Diameter of Head: 8.0mm

Drill Bit for Threaded Hole: 3.2mm

Drill Bit for Gliding Hole: 4.5mm

For Use With:

4.5/5.5/6.5mm Hexagonal Screwdriver

6.5mm Cancellous Tap

Smooth Washer for 4.5mm, 5.5mm, 6.5mm Screws

Spiked Washer for 4.5mm, 5.5mm, 6.5mm Screws

MWI#	SECUROS#	LENGTH (mm)
■ 370088	005282	35
■ 370089	005283	40
■ 370090	005284	45
■ 370091	005285	50
■ 370092	005286	55
■ 370093	005287	60
■ 370094	005288	65
■ 370095	005289	70
■ 370096	005290	75
■ 370097	005291	80
■ 370098	005292	85
■ 370099	005293	90
■ 370100	005294	95
■ 370101	005295	100

6.5mm Cancellous Screw, 32mm Thread Length, Hexagonal Recess - Stainless Steel



Diameter of Thread: 6.5mm

Diameter of Head: 8.0mm

Drill Bit for Threaded Hole: 3.2mm

Drill Bit for Gliding Hole: 4.5mm

For Use With:

4.5/5.5/6.5mm Hexagonal Screwdriver

6.5mm Cancellous Tap

Smooth Washer for 4.5mm, 5.5mm, 6.5mm Screws

Spiked Washer for 4.5mm, 5.5mm, 6.5mm Screws

MWI#	SECUROS#	LENGTH (mm)
055105	004154	50
■ 370102	004155	55
■ 370103	004156	60
■ 370105	004157	65
■ 370106	004158	70
■ 370170	004159	75
■ 370171	004160	80
■ 370172	004161	85
■ 370173	004162	90
■ 370174	004163	95
■ 370175	004164	100



■ special order item

Washers

Smooth Washers



MWI#	SECUROS#	RECOMMENDED SCREWS (mm)	OUTER DIAMETER (mm)	INNER DIAMETER (mm)	THICKNESS (mm)
036055	002446	1.5/2.0	4.5	2.2	0.5
042271	002444	2.4/2.7	6.5	2.8	1.0
042272	002445	2.7/3.5	7	4	1.0
042336	003655	4.0/4.5	10	5.2	1.0
042338	003656	4.5/5.5/6.5	13	6.8	1.0

Spiked Washers



MWI#	SECUROS#	RECOMMENDED SCREWS (mm)	OUTER DIAMETER (mm)	INNER DIAMETER (mm)	THICKNESS (mm)
042237	001884	2.0/2.4	8	3.2	4.0
045589	002607	2.4/2.7	8	3.8	4.0
042270	002441	2.7/3.5	13	4	4.0
042221	001656	3.5/4.0	11	4.8	3.5
035921	002442	4.5/5.5/6.5	13	6.8	3.5

INSTRUMENTS

Instruments for Conventional Plate Osteosynthesis



MWI#	SECUROS#	PRODUCT DESCRIPTION	LENGTH (")
042243	001922	Self-Holding Screw Forceps	3.5



MWI#	SECUROS#	PRODUCT DESCRIPTION	LENGTH (")
043946	001923	Plate Holding Forceps	4.5



MWI#	SECUROS#	PRODUCT DESCRIPTION	SPAN (mm)	LENGTH (")
■ 370112	001933	Articulated Tensioning Device	20	3.5



MWI#	SECUROS#	PRODUCT DESCRIPTION	FOR USE WITH	LENGTH (")
■ 370113	001934	Combination Wrench	Articulated Tensioning Device	6



MWI #	SECUROS #	PRODUCT DESCRIPTION	LENGTH (")
■ 370114	001935	Sharp Hook	6

■ special order item

Bending Instruments

Bending Templates



MWI#	SECUROS#	PLATE SIZE (mm)	# OF HOLES
045448	002051	3.5	7
045125	002052	3.5	9
045610	002053	4.5	7
045611	002055	4.5	12

Bending Irons



MWI#	SECUROS#	PRODUCT DESCRIPTION
042253	002056	1.5/2.0mm Bending Iron



MWI#	SECUROS#	PRODUCT DESCRIPTION
029100	002057	2.4/2.7/3.5mm Bending Iron Left
029101	002058	2.4/2.7/3.5mm Bending Iron Right



MWI#	SECUROS#	PRODUCT DESCRIPTION
042314	002948	3.5/4.5mm Bending Iron



MWI#	SECUROS#	PRODUCT DESCRIPTION
055011	004326	2.7/3.5mm Reconstruction Plate Bending Iron

Bending Instruments

Bending Pliers



MWI#	SECUROS#	PRODUCT DESCRIPTION
055169	002059	2.0/2.4/2.7mm Small Bending Pliers



MWI#	SECUROS#	PRODUCT DESCRIPTION
045449	002063	2.4/2.7/3.5mm Medium Bending Pliers

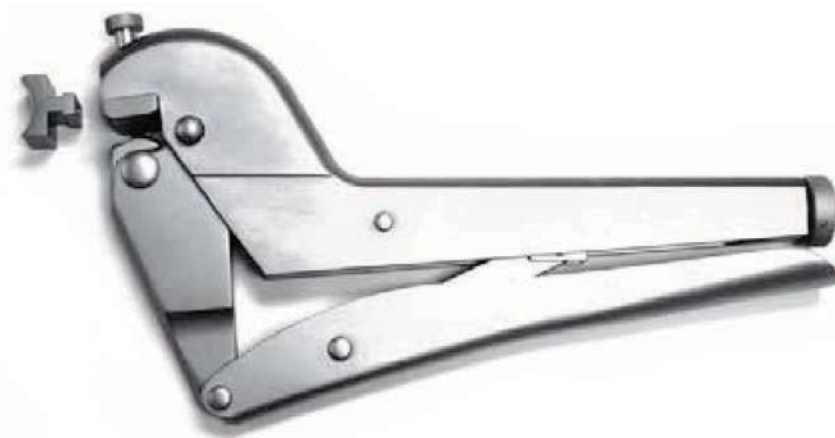

MWI#	SECUROS#	PRODUCT DESCRIPTION
044054	002064	3.5/4.5mm Large Bending Pliers

Bending Instruments

Bending Presses



002065



MWI#	SECUROS#	PRODUCT DESCRIPTION
055117	003891	Small Table Top Bending Press for use with Plates up to 3.5mm Broad
■ 276663	002065	Table Top Bending Press for use with Plates up to 4.5mm Broad

■ special order item

Drill Bits

Jacobs Chuck Coupling (BITE Bit, Titanium Nitride Coated)



MWI#	SECUROS#	DIAMETER (mm)	TOTAL LENGTH (mm)	FLUTE LENGTH (mm)	RECOMMENDED SCREWS (mm)	
					THREADED HOLE	GLIDING HOLE
028993	002034	1.1	45	22	1.5	-
028994	002035	1.5	70	23	2.0	1.5
031139	001017	1.8	131	26	2.4	-
028995	002036	2.0	85	50	2.7/4.0	2.0
031129	001358	2.4	143	32	-	2.4
028996	002037	2.5	95	50	3.5	-
028997	002038	2.7	85	50	-	2.7
028998	002039	3.2	130	40	4.5/6.5	-
029005	002040	3.5	100	43	-	3.5
029006	002041	4.0	130	50	-	4.0
042251	002042	4.5	130	50	-	4.5/6.5

Quick Coupling (BITE Bit, Titanium Nitride Coated)



MWI#	SECUROS#	DIAMETER (mm)	TOTAL LENGTH (mm)	FLUTE LENGTH (mm)	RECOMMENDED SCREWS (mm)	
					THREADED HOLE	GLIDING HOLE
029008	002043	1.1	60	15	1.5	-
029009	002044	1.5	85	18	2.0	1.5
036059	000395	1.8	140	32	2.4	-
029010	001018	2.0	100	22	2.7/4.0	2.0
042090	001361	2.4	140	32	-	2.4
029011	001019	2.5	110	32	3.5	-
029012	002045	2.7	100	29	-	2.7
042252	002046	3.2	145	43	4.5/6.5	-
029014	002047	3.5	100	43	-	3.5
042034	000366	4.0	160	50	-	4.0
029015	002048	4.5	145	50	-	4.5/6.5
048102	000367	5.5	195	50	-	5.5

Taps & Countersinks

Quick Coupling Taps



MWI#	SECUROS#	DIAMETER (mm)	SCREW TYPE	TOTAL LENGTH (mm)	THREAD LENGTH (mm)
042239	001906	1.5	Cortical	50	20
042240	001907	2.0	Cortical	53	24
029104	001908	2.7	Cortical	100	33
029105	001909	3.5	Cortical	110	51
029106	001910	4.5	Cortical	125	70
045135	002500	5.5	Cortical	135	60
042241	001911	4.0	Cancellous	110	45
■ 372182	002503	6.5	Cancellous	200	25

Countersinks



MWI#	SECUROS#	DIAMETER (mm)	FEATURE	LENGTH (")
043934	001912	1.5/2.0	Quick Coupling	2.25
043906	001913	2.7	Quick Coupling	2.25
043909	001914	3.5	Quick Coupling	2.75



MWI#	SECUROS#	DIAMETER (mm)	FEATURE	LENGTH (")
045212	001915	4.5	Handle	7

■ special order item

Drill Guides & Sleeves

Double Drill Guides



MWI#	SECUROS#	PRODUCT DESCRIPTION
030971	002066	1.1/1.5mm Double Drill Guide
030970	002067	1.5/2.0mm Double Drill Guide
055050	003824	1.8/2.4mm Double Drill Guide
031195	001022	2.0/2.7mm Double Drill Guide
030996	001023	2.5/3.5mm Double Drill Guide
031201	002278	3.2/4.5mm Double Drill Guide

Compressional Drill Guides



MWI#	SECUROS#	PRODUCT DESCRIPTION
029016	001902	2.0mm Compressional Drill Guide
042238	001903	2.7mm Compressional Drill Guide
029018	001904	3.5mm Compressional Drill Guide
048538	001905	4.5mm Compressional Drill Guide
048376	004095	3.5mm LC Compressional Drill Guide

Universal Drill Guides



MWI#	SECUROS#	PRODUCT DESCRIPTION
042267	002279	3.5mm Universal Drill Guide
055086	000905	5.5mm Universal Drill Guide

Drill Guides & Sleeves

Drill Sleeves



MWI#	SECUROS#	PRODUCT DESCRIPTION
045109	001901	2.5/3.5mm Insert Drill Sleeve
045099	000904	4.0/5.5mm Insert Drill Sleeve



MWI#	SECUROS#	PRODUCT DESCRIPTION
045392	000368	5.5mm Tap Sleeve



MWI#	SECUROS#	PRODUCT DESCRIPTION
■ 372175	001900	2.0mm Parallel Drill Guide & Drill Sleeve

■ special order item

Depth Gauges



MWI#	SECUROS#	PRODUCT DESCRIPTION	MEASURES UP TO (mm)	MEASUREMENT INCREMENTS (mm)
029097	002049	1.5/2.0/2.4mm Depth Gauge	30	2 & 5
029098	001020	2.7/3.5/4.0mm Depth Gauge	60	2 & 5
090001	005329	2.7/3.5/4.0mm Depth Gauge	60	1
029099	002050	4.5/5.5/6.5mm Depth Gauge	110	2 & 5

Screwdrivers, Handles, & Shafts

Screwdrivers (Includes holding sleeve)

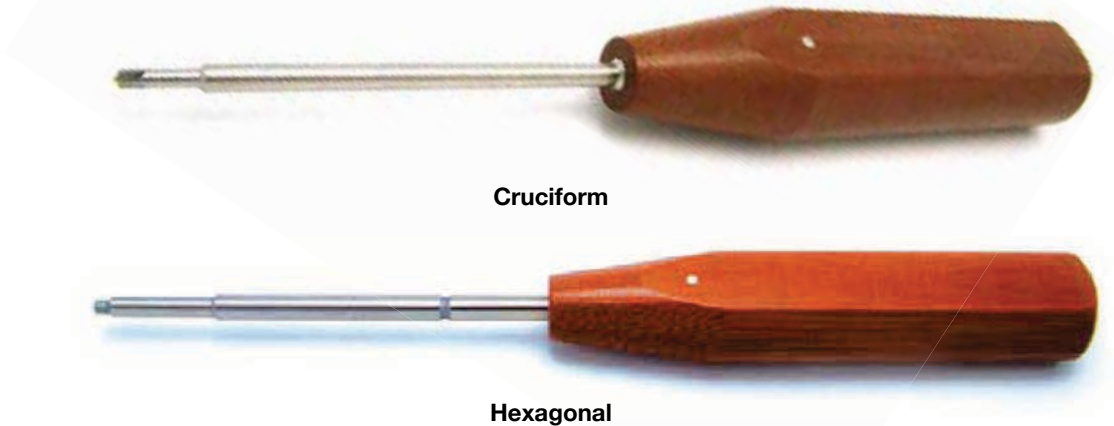

MWI#	SECUROS#	PRODUCT DESCRIPTION	LENGTH (")
042292	002504	1.5/2.0mm Hexagonal Screwdriver	6.75
042073	001026	1.5/2.0/2.4mm Cruciform Screwdriver	7
035880	003237	2.4mm Hexagonal Screwdriver	7
029524	001024	2.7/3.5/4.0mm Hexagonal Screwdriver	7.75
029526	001920	4.5/5.5/6.5mm Hexagonal Screwdriver	9.5

Screwdrivers, Handles, & Shafts

Screwdriver Shafts (Quick Coupling, Includes Holding Sleeve)



004660

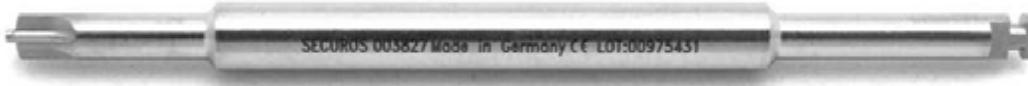

003827



001025

MWI#	SECUROS#	PRODUCT DESCRIPTION	FOR USE WITH	LENGTH (")
055058	004660	1.5/2.0mm Hexagonal Screwdriver Shaft	Mini QC Handle	2
056007	003827	1.5/2.0/2.4mm Cruciform Screwdriver Shaft	Mini QC Handle	2
055102	003904	2.4mm Hexagonal Screwdriver Shaft	Small, Large, Silicone QC Handles	4
029525	001025	2.7/3.5/4.0mm Hexagonal Screwdriver Shaft	Small, Large, Silicone QC Handles	4
029527	001921	4.5/5.5/6.5mm Hexagonal Screwdriver Shaft	Small, Large, Silicone QC Handles	4

Screwdriver Handles (Quick Coupling)



MWI#	SECUROS#	PRODUCT DESCRIPTION	ACCOMMODATES	LENGTH (")
042033	000123	Mini Handle	1.5/2.0mm Hexagonal & 1.5/2.0/2.4mm Cruciform Screwdriver Shafts	4.25



MWI#	SECUROS#	PRODUCT DESCRIPTION	ACCOMMODATES	LENGTH (")
029529	007003	Small Handle	2.7/3.5/4.0mm & 4.5/5.5/6.5mm Hexagonal Screwdriver Shafts	4.5



MWI#	SECUROS#	PRODUCT DESCRIPTION	ACCOMMODATES	LENGTH (")
029528	001916	Large Handle	2.7/3.5/4.0mm & 4.5/5.5/6.5mm Hexagonal Screwdriver Shafts	6

Screwdrivers, Handles, & Shafts

Screwdriver Handles (Quick Coupling)



MWI#	SECUROS#	PRODUCT DESCRIPTION	ACCOMMODATES	LENGTH (")
029530	001918	T-Handle	2.7mm - 6.5mm Taps	3.25



MWI#	SECUROS#	PRODUCT DESCRIPTION	ACCOMMODATES	LENGTH (")
052748	007180	Silicone Handle	2.7/3.5/4.0mm & 4.5/5.5/6.5mm Hexagonal Screwdriver Shafts	5.5

Screwdriver Holding Sleeves



005502



003661



005505

MWI#	SECUROS#	PRODUCT DESCRIPTION
052741	005502	1.5/2.0mm Standard Hexagonal Screwdriver Holding Sleeve
036057	003661	2.4mm Standard Hexagonal Screwdriver Holding Sleeve
043904	002190	2.7/3.5/4.0mm Standard Hexagonal Screwdriver Holding Sleeve
055170	005505	4.5/5.5/6.5mm Spring Loaded Hexagonal Screwdriver Holding sleeve

Screw Extraction



Set

MWI#	SECUROS#	PRODUCT DESCRIPTION
■ 370115	000829	Screw Extraction Set (SOS Set)

Instruments

MWI#	SECUROS#	PRODUCT DESCRIPTION
■ 370116	004491	Large Forceps for Broken Screw Removal
390153	004492	Hollow Gouge 4mm
390154	004493	Hollow Gouge 6mm
390155	004494	Hollow Gouge 10mm
■ 370117	004495	6" QC T-Handle



Extraction Bolts

MWI#	SECUROS#	PRODUCT DESCRIPTION
390156	003899	Extraction Bolt for 1.5mm Screws
048315	003900	Extraction Bolt for 2.0mm Screws
390157	003901	Extraction Bolt for 2.7/3.0mm Screws
390158	003902	Extraction Bolt for 3.5/4.0mm Screws
045165	003548	Extraction Bolt for 4.5/5.0mm Screws
■ 370118	004489	Extraction Bolt for 6.5/7.0mm Screws

Instruments



Reamers

MWI#	SECUROS#	PRODUCT DESCRIPTION
390159	004467	Hollow Reamer for 2.7mm Screws
390160	004468	Hollow Reamer for 3.5/4.0mm Screws
■ 370119	004469	Hollow Reamer for 4.5mm Screws
■ 370510	004478	Hollow Reamer for 6.5mm/7.0mm Screws

Extractors and Handle

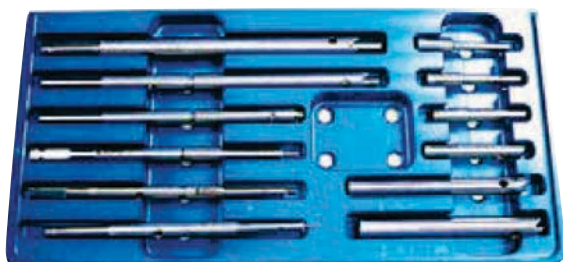

Reamers and Centering Pins

■ special order item

Spare Reamer Tubes

MWI#	SECUROS#	PRODUCT DESCRIPTION
390161	004485	2.7mm Spare Reamer Tube
390162	004486	3.5/4.0mm Spare Reamer Tube
■ 370513	004487	4.5mm Spare Reamer Tube
■ 370514	004488	6.5/7.0mm Spare Reamer Tube

Conical Extraction Screws

MWI#	SECUROS#	PRODUCT DESCRIPTION
390163	003549	Conical Extraction Screws for 2.7mm & 3.5mm Screws
048255	003561	Conical Extraction Screws for Large Screws and 4.9mm Bolts



STERILIZATION CONTAINERS

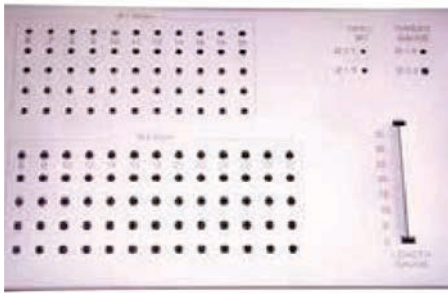

000882

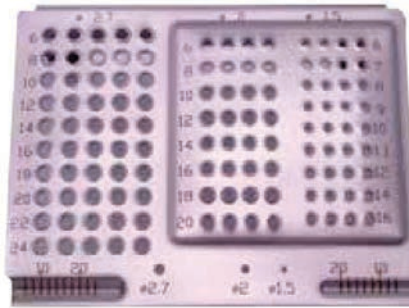

002320

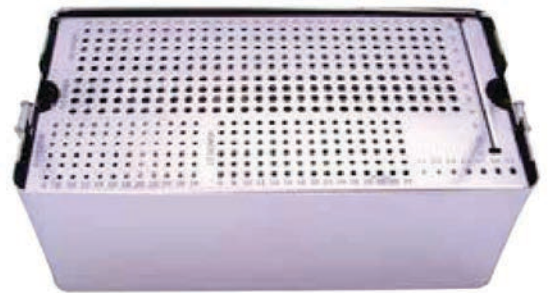

003750

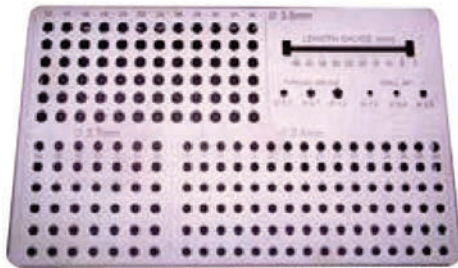

000883

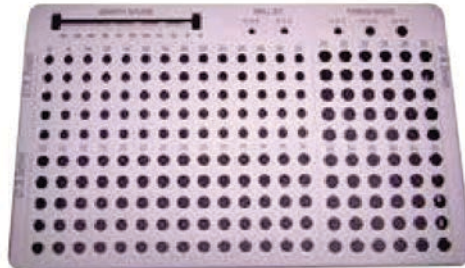

000881

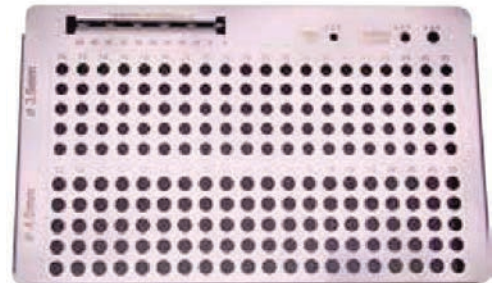

002997

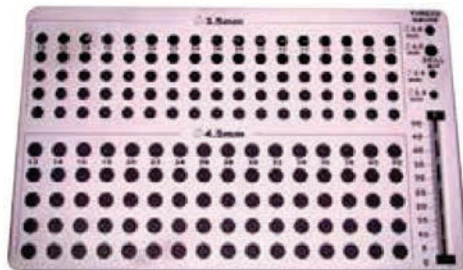

003289

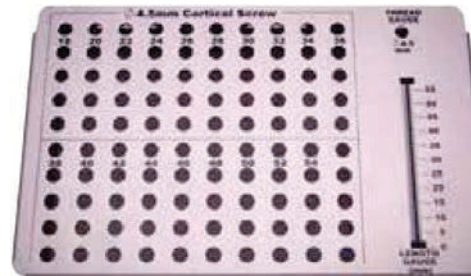

000885



002315



003752

MWI#	SECUROS#	PRODUCT DESCRIPTION	LENGTH (")	WIDTH (")	HEIGHT (")
045549	000882	Screw Rack for 1.5/2.0mm Cortical Screws	6.5	4.25	2.25
ACCOMMODATES					
1.5mm Screws 5 ea.: 6mm-12mm (Increments of 1mm), 14mm-20mm (Increments of 2mm), 2.0mm Screws 5 ea.: 6mm-30mm (Increments of 2mm)					

MWI#	SECUROS#	PRODUCT DESCRIPTION	LENGTH (")	WIDTH (")	HEIGHT (")
044068	002320	Screw Rack for 1.5/2.0/2.7mm Cortical Screws	4.5	3.25	2.25
ACCOMMODATES					
1.5mm Screws 4 ea.: 6-12mm (Increments of 1mm), 14-16mm (Increments of 2mm), 2.0mm Screws 4 ea.: 6-20mm (Increments of 2mm), 2.7mm Screws 5 ea.: 6-24mm (Increments of 2mm)					

MWI#	SECUROS#	PRODUCT DESCRIPTION	LENGTH (")	WIDTH (")	HEIGHT (")
056009	003750	Screw Rack for 2.0/2.7/3.5/4.0mm Cortical Screws	11	5.75	4.25
ACCOMMODATES					
2.0mm Screws 6 ea.: 6mm-28mm (Increments of 2mm), 2.7mm Screws 6 ea.: 6mm-34mm (Increments of 2mm), 3.5mm Screws 5 ea.: 10mm-40mm (Increments of 2mm), 45mm-100mm (Increments of 5mm), 4.0mm Screws 4 ea.: 10mm-40mm (Increments of 2mm), 45mm-100mm (Increments of 5mm)					

MWI#	SECUROS#	PRODUCT DESCRIPTION	LENGTH (")	WIDTH (")	HEIGHT (")
042069	000883	Screw Rack for 2.4/2.7/3.5mm Cortical Screws	6.5	4.25	2.25
ACCOMMODATES					
2.4mm Screws 6 ea.: 10mm-40mm (Increments of 2mm), 2.7mm Screws 6 ea.: 14mm-26mm (Increments of 2mm), 3.5mm Screws 6 ea.: 12mm-34mm (Increments of 2mm)					

MWI#	SECUROS#	PRODUCT DESCRIPTION	LENGTH (")	WIDTH (")	HEIGHT (")
045560	000881	Screw Rack for 2.7/3.5mm Cortical & 4.0mm Cancellous Screws	6.5	4.25	2.25
ACCOMMODATES					
2.7mm Screws 5 ea.: 6mm-32mm (Increments of 2mm), 3.5mm Screws 5 ea.: 12mm-38mm (Increments of 2mm), 4.0mm Screws 5 ea.: 20mm-42mm (Increments of 2mm)					

MWI#	SECUROS#	PRODUCT DESCRIPTION	LENGTH (")	WIDTH (")	HEIGHT (")
045476	002997	Screw Rack for 3.5mm Cortical & 4.0mm Cancellous Screws	6.5	4.25	2.25
ACCOMMODATES					
3.5mm Screws 5 ea.: 10mm-44mm (Increments of 2mm), 45mm, 50mm, 4.0mm Screws 5 ea.: 12mm-44mm (Increments of 2mm), 45mm, 46mm, 50mm					

MWI#	SECUROS #	PRODUCT DESCRIPTION	LENGTH (")	WIDTH (")	HEIGHT (")
045628	003289	Screw Rack for 3.5/4.5mm Cortical Screws	6.5	4.25	2.25
ACCOMMODATES					
3.5mm Screws 5 ea.: 10mm-40mm (Increments of 2mm), 45mm, 4.5mm Screws 5 ea.: 12mm-40mm (Increments of 2mm), 50mm					

MWI#	SECUROS#	PRODUCT DESCRIPTION	LENGTH (")	WIDTH (")	HEIGHT (")
055085	000885	Screw Rack for 4.5mm Cortical Screws	6.5	4.25	2.25
ACCOMMODATES					
4.5mm Screws 5 ea.: 18mm-54mm (Increments of 2mm)					

MWI#	SECUROS#	PRODUCT DESCRIPTION	LENGTH (")	WIDTH (")	HEIGHT (")
048564	002315	Screw Rack for 4.5/6.5mm Cortical Screws	11.5	4.5	2.25
ACCOMMODATES					
4.5mm Screws 7 ea.: 14mm, 8 ea.: 16mm-28mm (Increments of 2mm), 16 ea.: 30mm, 12 ea.: 32mm-40mm (Increments of 2mm), 44mm, 6 ea.: 42mm, 46mm, 48mm, 52mm, 56mm, 60mm, 6.5mm Screws 6 ea.: 25mm-60mm (Increments of 5mm)					

MWI#	SECUROS#	PRODUCT DESCRIPTION	LENGTH (")	WIDTH (")	HEIGHT (")
055101	003752	Screw Rack for 5.5mm Cortical Screws	12.5	5.25	3.75
ACCOMMODATES					
5.5mm Screws 6 ea.: 22mm-100mm (Increments of 2mm)					



MWI#	SECUROS#	PRODUCT DESCRIPTION	LENGTH (")	WIDTH (")	HEIGHT (")
042039	000418	Internal Fixation Organizer Case - Blue Cover w/ Logo	13	6	4.5



MWI#	SECUROS#	PRODUCT DESCRIPTION	LENGTH (")	WIDTH (")	HEIGHT (")
056017	002872	Small Fragment Instrument Case - Aluminum (red)	12	4.75	3

Plate Stringers

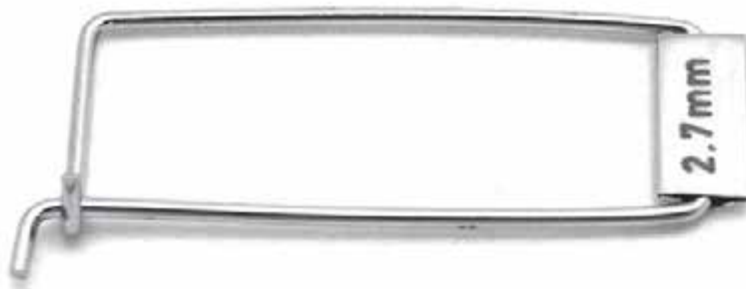

MWI#	SECUROS#	RECOMMENDED PLATES
043901	000402	2.0
043903	000401	2.7
043908	000400	3.5

REFERENCE MATERIALS

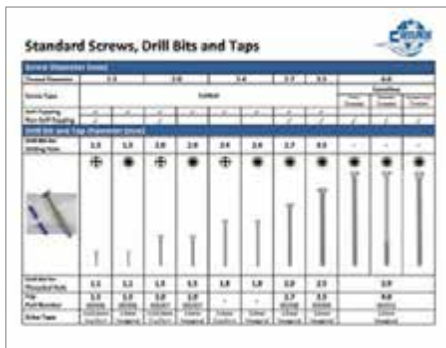

005094

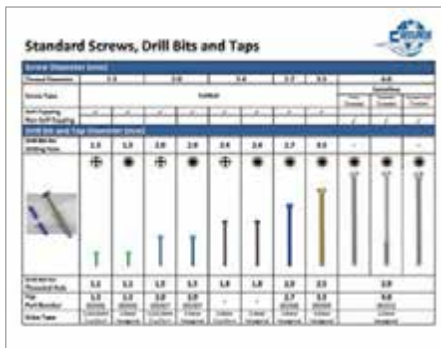

005095



004939

MWI#	SECUROS#	PRODUCT DESCRIPTION
■ 388988	005094	Standard Screw Reference - Stainless Steel
■ 388989	005095	Standard Screw Reference - Titanium
■ 388990	004939	Washer Reference



Top



Bottom

MWI#	SECUROS#	PRODUCT DESCRIPTION
048584	840920	Screw & Drill Bit Gauge

■ special order item

SECUROS Locking Plate Freedom

- **Polyaxial** locking up to 10°
- **Titanium** implants
- **Interchangeable** screws between 2.0/2.4mm & 2.7/3.5mm systems
- Ability to remove screws & adjust **angulation**



Radiograph provided by: Fred Pike, DVM, DACVS
Veterinary Specialty Hospital



Radiograph provided by: David Mason, DVM, MRCVS,
DACVS, DECVS Las Vegas Veterinary Specialty Center



PAX RP



PAX SP

PAX Polyaxial Advanced Locking Veterinary Osteosynthesis System

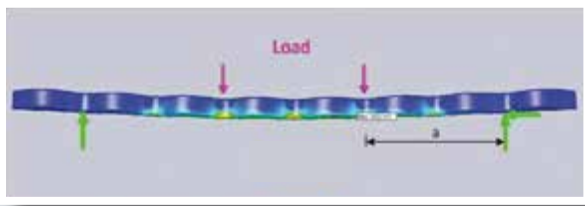

In 2009, SECUROS introduced the PAX System in an effort to combine the advantages of conventional plate systems and locking plate systems to provide the veterinary surgeon the **best of both worlds**. The PAX system is designed for operative fracture treatment, anatomical reconstruction, and re-establishment of lost functionality. The **modern plate geometries** offer the veterinary surgeon a wide range of application from extremities to the spine. The plates and screws present a stable locking system to provide the fundamental conditions for **bone osteosynthesis**. Because it is possible to lock the plates without pressing them onto the bone it reduces damage to the blood supply. The angularly-stable screw-plate locking system offers a **polyaxial insertion** of the screws into the plate at an angle of **+/- 10 degrees**. The stability of the fracture treatment is the result of the **high construct stiffness** and is almost independent of the bone quality, contact pressure, and whether the plate is precisely formed to the bone or not. The loading is transferred directly from the screw to the plate. The **locking mechanism** utilizes plastic deformation of the plate on the screw head thread while inserting the screw and is reliable for repeated insertion of the screw. **Benefits** of the PAX Advanced Locking System include:

- Titanium and titanium alloy for **supreme biocompatibility**
- **Polyaxial** locking up to 10 degrees
- Available in both **contourable RP** (Reconstruction Plate) or **rigid SP** (Straight Plate) styles
- SP plates feature **comparable stiffness** compared to conventional plates ¹
- SP plates are approximately **40% stiffer** than RP plates¹
- **Angle stable** locking without significant screw pushout loss up to 5 degrees and great results up to 10 degrees ²
- Plates **accept both** PAX locking and conventional screws
- **Interchangeable** locking screws between 2.0/2.4mm and 2.7/3.5mm systems
- Biological **internal fixation** design rationale with good **clinical outcomes** ³
- **Patented** locking technology

1. Internal mechanical testing data results available upon request.

2. Bufkin BW, Barnhart MD, Kazanovicz AJ et al. The effect of screw angulation and insertion torque on the push-out strength of polyaxial locking screws and the single cycle to failure in bending of polyaxial locking plates. *Vet Comp Orthop Traumatol* 2013; 26: 186-191.

3. Barnhart MD, Rides CF, Kennedy SC et al. Fracture repair using a polyaxial locking plate system (PAX). *Vet Surg* 2012; 42: 60-66.

*Radiograph provided by Cristóbal Frias Rides, DVM.

IMPLANTS

2.0mm PAX Locking Straight Plates

2.0mm Locking Reconstruction Plates (RP) - Titanium (Light Blue)



Width: 6.0mm

Thickness: 1.5mm

Distance Between Center of Holes: 6.0mm

MWI#	SECUROS#	# OF HOLES	LENGTH (mm)
045529	007010	3	18
042171	007011	4	24
042173	007012	5	30
042174	007013	6	36
042175	007014	7	42
042176	007015	8	48
042178	007016	9	54
044622	007017	10	60

2.0mm Locking Limited Contact Straight Plates (SP) - Titanium (Light Blue)



Width: 6.0mm

Thickness: 1.5mm

Distance Between Center of Holes: 6.0mm

MWI#	SECUROS#	# OF HOLES	LENGTH (mm)
049587	007150	5	34
049588	007151	6	40
049589	007152	7	46
049590	007153	8	52
049591	007154	9	58
049592	007155	10	64
049593	007156	20	124

2.4mm PAX Locking Straight Plates

2.4mm Locking Reconstruction Plates (RP) - Titanium (Copper)



Width: 8.0mm

Thickness: 2.0mm

Distance Between Center of Holes: 7.5mm

MWl#	SECUROS#	# OF HOLES	LENGTH (mm)
044626	007018	4	30
042179	007019	5	37.5
042181	007020	6	45
044627	007021	7	52.5
042182	007022	8	60
042183	007023	9	67.5
044623	007024	10	75
044624	007025	12	90
044625	007026	14	105

2.4mm Locking Limited Contact Straight Plates (SP) - Titanium (Copper)



Width: 8.0mm

Thickness: 2.0mm

Distance Between Center of Holes: 7.5mm

MWl#	SECUROS#	# OF HOLES	LENGTH (mm)
049596	007160	5	42
049597	007161	6	49
049598	007162	7	57
049599	007163	8	64
049600	007164	9	72
049601	007165	10	79
049602	007166	12	94
049603	007167	14	109
049604	007168	20	154

2.7mm PAX Locking Straight Plates

2.7mm Locking Reconstruction Plates (RP) - Titanium (Blue)



Width: 9.5mm

Thickness: 2.5mm

Distance Between Center of Holes: 9.0mm

MWI#	SECUROS#	# OF HOLES	LENGTH (mm)
044638	002804	4	36
044639	002805	5	45
044641	002806	6	54
044642	002807	7	63
042306	002808	8	72
044643	002809	9	81
044634	002810	10	90
044635	002812	12	108
044636	007067	14	126
044637	007068	16	144

2.7mm Locking Limited Contact Straight Plates (SP) - Titanium (Blue)



Width: 8.5mm

Thickness: 2.5mm

Distance Between Center of Holes: 9.0mm

MWI#	SECUROS#	# OF HOLES	LENGTH (mm)
045204	004522	4	39
044944	004523	5	48
044945	004524	6	57
044946	004525	7	66
044947	004526	8	75
044948	004527	9	84
044949	004528	10	93
044899	004529	12	111
044950	004530	14	129
044951	004531	16	147

3.5mm PAX Locking Straight Plates

3.5mm Locking Reconstruction Plates (RP) - Titanium (Gold)



Width: 12.0mm

Thickness: 3.2mm

Distance Between Center of Holes: 11.0mm

MWI#	SECUROS#	# OF HOLES	LENGTH (mm)
042244	001941	4	44
044656	001942	5	55
042245	001943	6	66
044657	001944	7	77
042246	001945	8	88
044658	001946	9	99
042247	001947	10	110
044650	001948	11	121
044651	001949	12	132
044652	007071	14	154
044653	007072	15	165
044654	007073	16	176
044952	007074	18	198
044655	007075	20	220

3.5mm Locking Limited Contact Straight Plates (SP) - Titanium (Gold)



Width: 11.0mm

Thickness: 3.2mm

Distance Between Center of Holes: 12.0mm

MWI#	SECUROS#	# OF HOLES	LENGTH (mm)
045530	004507	4	50
044955	004508	5	62
045531	004509	6	74
044942	004510	7	86
045556	004511	8	98
045199	004512	9	110
045060	004513	10	122
045200	004514	11	134
055056	004515	12	146
048381	004516	13	158
045201	004517	14	170
044943	004518	15	182
048179	004519	16	194
045202	004520	18	218
045203	004521	20	242

PAX Locking T-Plates

2.0mm Locking T-Plates - Titanium (Light Blue)



Head Width: 12.0mm

Shaft Width: 6.0mm

Thickness: 1.5mm

MWI#	SECUROS#	# HOLES HEAD	# HOLES SHAFT	OVERALL LENGTH (mm)
042184	007027	2	2	18
042185	007028	2	3	24
042186	007029	2	4	30
042187	007030	2	5	36
042188	007031	2	6	42
042189	007032	2	7	48

2.4mm Locking T-Plates - Titanium (Copper)



Head Width: 15.0mm

Shaft Width: 8.0mm

Thickness: 2.0mm

MWI#	SECUROS#	# HOLES HEAD	# HOLES SHAFT	OVERALL LENGTH (mm)
044628	007033	2	2	22.5
044629	007034	2	3	30
044630	007035	2	4	37.5
044631	007036	2	5	45
044632	007037	2	6	52.5
044633	007038	2	7	60

2.0mm PAX Locking Butterfly Plates - Titanium (Light Blue)



4 Holes

Width: 11.5mm

Thickness: 2.0mm

MWI#	SECUROS#	LENGTH (mm)
090008	007145	12
090006	007143	14
090007	007144	16

PAX Locking Screws

2.0mm PAX Locking Screw, Self-Tapping, Star Recess - Titanium (Light Blue)



Diameter of Thread: 2.0mm

Diameter of Head: 3.0mm

Drill Bit For Threaded Hole: 1.3mm

For Use With T6 Stardrive Screwdriver

MWI#	SECUROS#	LENGTH (mm)
042190	007039	6
042191	007040	8
042192	007041	10
042193	007042	12
042194	007043	14
042195	007044	16
042196	007045	18
042197	007046	20

2.4mm PAX Locking Screw, Self-Tapping, Star Recess - Titanium (Copper)



Diameter of Thread: 2.4mm

Diameter of Head: 3.0mm

Drill Bit For Threaded Hole: 1.7mm

For Use With T6 Stardrive Screwdriver

MWI#	SECUROS#	LENGTH (mm)
042198	007047	6
042199	007048	8
042337	007049	10
042342	007050	12
042343	007051	14
042344	007052	16
042346	007053	18
042348	007054	20
042349	007055	22
042350	007056	24

PAX Locking Screws

2.7mm PAX Locking Screw, Self-Tapping, Star Recess - Titanium (Blue)



Diameter of Thread: 2.7mm

Diameter of Head: 5.0mm

Drill Bit For Threaded Hole: 2.0mm

For Use With T15 Stardrive Screwdriver

MWI#	SECUROS#	LENGTH (mm)
042279	002485	8
042280	002486	10
042281	002487	12
042282	002488	14
042283	002489	16
042284	002490	18
042285	002491	20
042286	002492	22
042287	002493	24
042288	002494	26

MWI#	SECUROS#	LENGTH (mm)
042289	002495	28
042290	002496	30
042291	002497	32
044644	002498	34
044645	002499	36
044646	007077	38
044647	007078	40
044648	007079	45
044649	007080	50

3.5mm PAX Locking Screw, Self-Tapping, Star Recess - Titanium (Gold)



Diameter of Thread: 3.5mm

Diameter of Head: 5.0mm

Drill Bit For Threaded Hole: 2.5mm

For Use With T15 Stardrive Screwdriver

MWI#	SECUROS#	LENGTH (mm)
042356	007081	8
042357	007082	10
042359	007083	12
042361	007084	14
042364	007085	16
042366	007086	18
042368	007087	20
042369	007088	22
044659	007089	24
042100	007090	26
042105	007091	28
042106	007092	30
042107	007093	32

MWI#	SECUROS#	LENGTH (mm)
042108	007094	34
042109	007095	36
042111	007096	38
042112	007097	40
042113	007098	42
042114	007099	44
042115	007100	46
042116	007101	48
042117	007102	50
042118	007103	52
042119	007104	54
042120	007105	56

INSTRUMENTS

Instruments for PAX Locked Plating System



MWI#	SECUROS#	PRODUCT DESCRIPTION	LENGTH (")
042389	007006	PAX Plate Holding Forceps	5.5

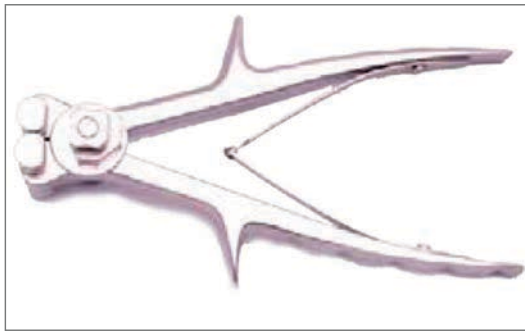

PAX Reconstruction Plate Blending Pliers



Front



Back

MWI#	SECUROS#	PRODUCT DESCRIPTION	ACCOMMODATES	LENGTH (")
■	007185	PAX Reconstruction Plate Bending Pliers	2.0/2.4/2.7/3.5mm RP Plates	7.5

Drill Bits (Quick Coupling, BITE Bit, Titanium Nitride Coated)



MWI#	SECUROS#	DIAMETER (mm)	TOTAL LENGTH (mm)	FLUTE LENGTH (mm)	RECOMMENDED SCREWS (mm)
042390	007007	1.3	80	16	2.0
042391	007008	1.7	90	19	2.4
029010	001018	2.0	100	23	2.7
029011	001019	2.5	110	32	3.5

■ special order item

Drill Guides



MWI#	SECUROS#	PRODUCT DESCRIPTION
042388	007005	2.0/2.4mm PAX Double Drill Guide
042354	007062	2.7/3.5mm PAX Double Drill Guide



MWI#	SECUROS#	PRODUCT DESCRIPTION
051986	007175	2.0mm PAX Neutral/Load (Compressional) Drill Guide
051987	007176	2.4mm PAX Neutral/Load (Compressional) Drill Guide
051988	007177	2.7mm PAX Neutral/Load (Compressional) Drill Guide
051989	007178	3.5mm PAX Neutral/Load (Compressional) Drill Guide

Depth Gauges



MWI	SECUROS#	PRODUCT DESCRIPTION	MEASURES UP TO (mm)	MEASUREMENT INCREMENTS
042392	007009	2.0/2.4mm PAX Locking System Depth Gauge	30	1
042355	007066	2.7/3.5mm PAX Locking System Depth Gauge	60	1

Screwdriver Shafts & Handles

Screwdriver Shafts (Quick Coupling)



MWI#	SECUROS#	PRODUCT DESCRIPTION	LENGTH (")
042387	007004	2.0/2.4mm PAX Stardrive Screwdriver Shaft (T6)	2.2
042353	007061	2.7/3.5mm PAX Stardrive Screwdriver Shaft (T15)	2.2

Screwdriver Handle (Quick Coupling)



MWI#	SECUROS#	PRODUCT DESCRIPTION	ACCOMMODATES	LENGTH (")
029529	007003	Small Handle	2.7/3.5/4.0mm & 4.5/5.5/6.5mm Hexagonal Screwdriver Shafts	4.5



MWI#	SECUROS#	PRODUCT DESCRIPTION	ACCOMMODATES	LENGTH (")
029528	001916	Large Handle	2.7/3.5/4.0mm & 4.5/5.5/6.5mm Hexagonal Screwdriver Shafts	6



MWI#	SECUROS#	PRODUCT DESCRIPTION	ACCOMMODATES	LENGTH (")
052748	007361	Silicone Handle	2.7/3.5/4.0mm & 4.5/5.5/6.5mm Hexagonal Screwdriver Shafts	5.5

STERILIZATION CONTAINERS

PAX 2.0/2.4mm Trays & Covers



007001

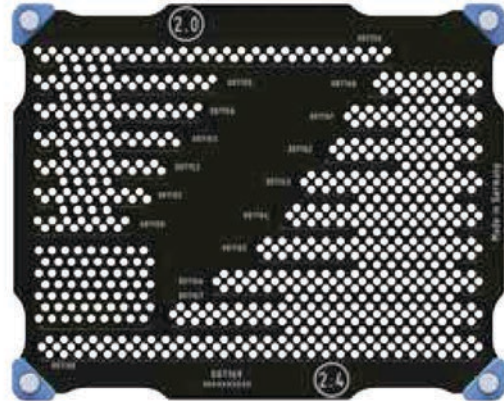

007169

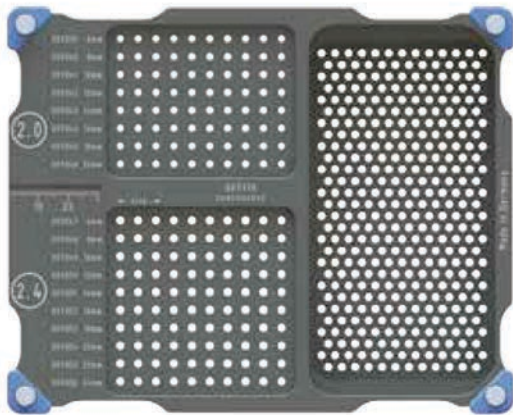

007170

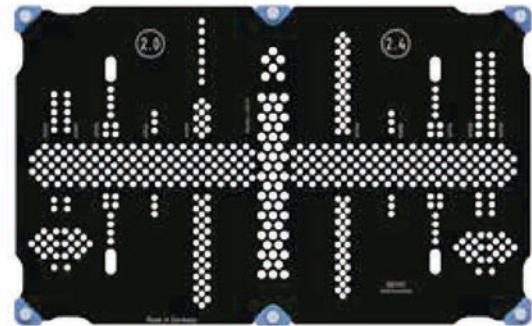

007171

* Order Quantity 2

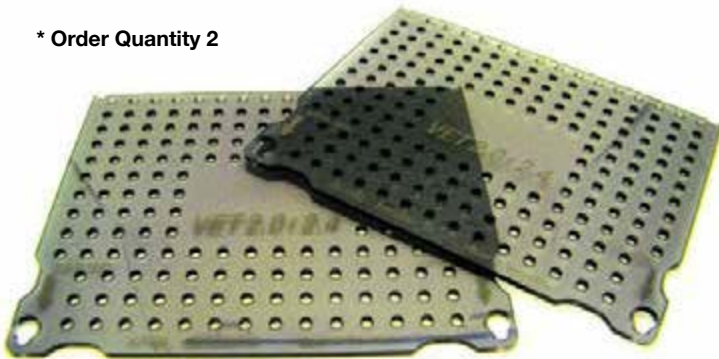

007002



007183

MWI#	SECUROS#	PRODUCT DESCRIPTION	LENGTH (")	WIDTH (")	HEIGHT (")
042385	007001	2.0/2.4mm PAX RP Tray	10.75	6.75	1.5
ACCOMMODATES					
2.0mm Plates 2 ea.: 3-10 hole (Increments of 1), 2.4mm Plates 2 ea.: 4-10 hole (Increments of 1), 12 hole, 14 hole, 2.0mm T-Plates 2 ea.: 2 hole head x 2-7 hole shaft (Increments of 1), 2.4mm T-Plates 2 ea.: 2 hole head x 2-7 hole shaft (Increments of 1), 2.0mm Screws 10 ea.: 6-12mm (Increments of 2mm), 6 ea.: 14-16mm (Increments of 2mm), 4 ea.: 18-20mm (Increments of 2mm), 2.4mm Screws 10 ea.: 6-14mm (Increments of 2mm), 6 ea.: 16-20mm (Increments of 2mm), 4 ea.: 22-24mm (Increments of 2mm), 1.3mm Drill Bit, 1.7mm Drill Bit, 1.3mm/1.7mm Double Drill Guide, T6 Stardrive Screwdriver Shaft: 2, 2.0/2.4mm PAX Depth Gauge, Small Handle, PAX Plate Holding Forceps					

MWI#	SECUROS#	PRODUCT DESCRIPTION	LENGTH (")	WIDTH (")	HEIGHT (")
051703	007169	2.0/2.4mm PAX SP Tray	6.75	5.5	1.5
ACCOMMODATES					
2.0mm Plates 2 ea.: 5-10 Hole (Increments of 1), 20 Hole, 2.4mm Plates 2 ea.: 5-12 Hole (Increments of 1), 20 Hole					

MWI#	SECUROS#	PRODUCT DESCRIPTION	LENGTH (")	WIDTH (")	HEIGHT (")
041701	007170	2.0/2.4mm PAX Screw Rack	6.75	5.5	1.5
ACCOMMODATES					
2.0mm Screws 10 ea.: 6-20mm (Increments of 2mm), 2.4mm Screws 10 ea.: 6-24mm (Increments of 2mm)					

MWI#	SECUROS#	PRODUCT DESCRIPTION	LENGTH (")	WIDTH (")	HEIGHT (")
051706	007171	2.0/2.4mm PAX Instrument Tray	10.75	6.75	1.5
ACCOMMODATES					
1.3mm Drill Bit: 2, 1.7mm Drill Bit: 2, 1.3mm Compressional Drill Guide, 1.7mm Compressional Drill Guide, T6 Stardrive Screwdriver Shaft: 2, 2.0/2.4mm Depth Gauge, Small Handle, PAX Plate Holding Forceps					

MWI#	SECUROS#	PRODUCT DESCRIPTION	LENGTH (")	WIDTH (")	
042386	007002	2.0/2.4mm PAX Full Tray Cover * Order QTY 2	6.65	5.35	
FOR USE WITH					
007001, 007171					

MWI#	SECUROS#	PRODUCT DESCRIPTION	LENGTH (")	WIDTH (")	
051707	007183	2.0/2.4mm PAX Half Tray Cover	6.65	5.35	
FOR USE WITH					
007169, 007170					

PAX 2.7/3.5mm Trays & Covers



007058

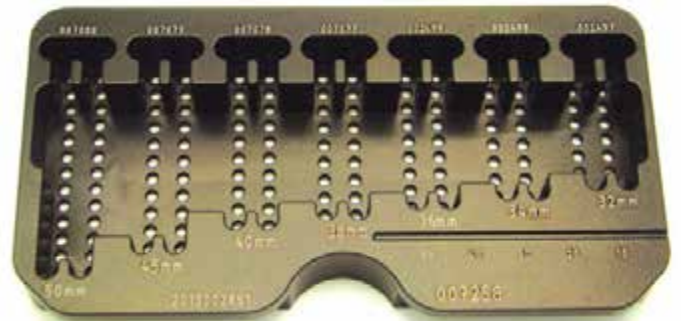

007258



007158

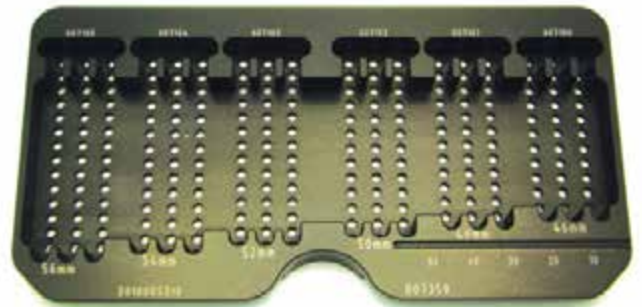

007358



007173

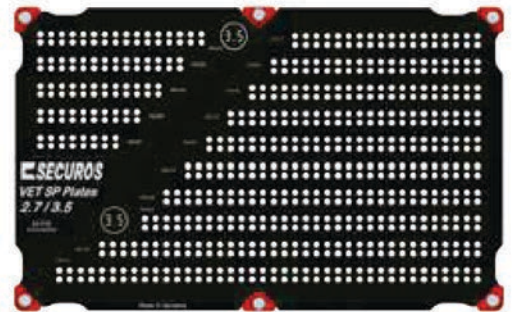

007172



007360

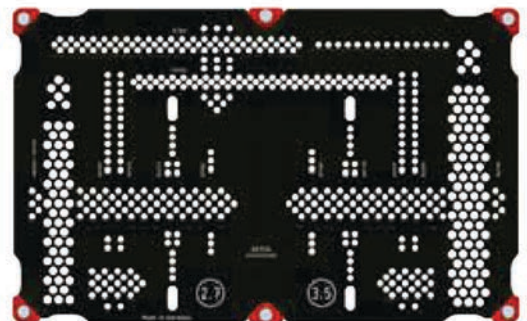

007174

MWI#	SECUROS#	PRODUCT DESCRIPTION	LENGTH (")	WIDTH (")	HEIGHT (")
042351	007058	2.7mm PAX RP Tray	10.75	6.75	1.5
ACCOMMODATES					
2.7mm Plates 2 ea.: 4-10 Hole (Increments of 1), 12-16 Hole (Increments of 2), 2.7mm Screws 5 ea.: 8-26mm (Increments of 2mm), 4 ea.: 28-30mm (Increments of 2mm), 2.0mm Drill Bit, 2.0/2.5mm Double Drill Guide, T15 Stardrive Screwdriver: 2, 2.7/3.5mm PAX Depth Gauge, Small Handle, Silicone Handle, PAX Plate Holding Forceps					

MWI#	SECUROS#	PRODUCT DESCRIPTION	LENGTH (")	WIDTH (")	HEIGHT (")
042122	007258	2.7mm PAX RP Tray Screw Insert *for 007058*	5.25	2.75	0.75
ACCOMMODATES					
2.7mm Screws 4 ea.: 32-40mm (Increments of 2mm), 45mm, 50mm					

MWI#	SECUROS#	PRODUCT DESCRIPTION	LENGTH (")	WIDTH (")	HEIGHT (")
042121	007158	3.5mm PAX RP Tray	10.75	6.75	1.5
ACCOMMODATES					
3.5mm Plates 2 ea.: 4-12 Hole (Increments of 1), 14-20 Hole (Increments of 2), 3.5mm Screws 5 ea.: 8-26mm (Increments of 2mm), 4 ea.: 28-30mm (Increments of 2mm), 2.5mm Drill Bit					

MWI#	SECUROS#	PRODUCT DESCRIPTION	LENGTH (")	WIDTH (")	HEIGHT (")
042123	007358	3.5mm PAX RP Tray Screw Insert *for 007158*	6	3.25	0.5
ACCOMMODATES					
3.5mm Screws 4 ea.: 46-56mm (Increments of 2mm)					

MWI#	SECUROS#	PRODUCT DESCRIPTION	LENGTH (")	WIDTH (")	HEIGHT (")
051704	007173	2.7mm PAX SP Tray Insert *for 007172*	10	6	0.5
ACCOMMODATES					
2.7mm Plates 2 ea.: 4-10 Hole (Increments of 1), 12-16 Hole (Increments of 2)					

MWI #	SECUROS #	PRODUCT DESCRIPTION	LENGTH (")	WIDTH (")	HEIGHT (")
051705	007172	3.5mm PAX SP Tray	10.75	6.75	1.5
ACCOMMODATES					
3.5mm Plates 2 ea.: 4-16 Hole (Increments of 1), 18 Hole, 20 Hole					

MWI#	SECUROS#	PRODUCT DESCRIPTION	LENGTH (")	WIDTH (")	HEIGHT (")
090011	007360	2.7/3.5mm PAX Screw Rack	6.75	5.5	2.75
ACCOMMODATES					
2.7mm Screws 8 ea.: 8-40mm (Increments of 2mm), 45mm, 50mm, 3.5mm Screws 8 ea.: 8-56mm (Increments of 2mm)					

MWI#	SECUROS#	PRODUCT DESCRIPTION	LENGTH (")	WIDTH (")	HEIGHT (")
	007174	2.7/3.5mm PAX Instrument Tray	10.75	6.75	1.5
ACCOMMODATES					
2.0mm Drill Bit: 2, 2.5mm Drill Bit: 2, 2.0mm Compressional Drill Guide, 2.5mm Compressional Drill Guide, T15 Stardrive Screwdriver Shaft: 2, 2.7/3.5mm PAX Depth Gauge, Small Handle, Silicone Handle, PAX Plate Holding Forceps					

PAX 2.7/3.5mm Trays and Covers

* Order Quantity 2



007059



004903

MWI#	SECUROS#	PRODUCT DESCRIPTION	LENGTH (")	WIDTH (")	
042352	007059	2.7/3.5mm PAX Full Tray Cover *Order QTY 2	6.65	5.35	
FOR USE WITH					
007058, 007158, 007172, 007174					

MWI#	SECUROS#	PRODUCT DESCRIPTION	LENGTH (")	WIDTH (")	
051948	004903	2.7/3.5mm PAX Half Tray Cover	6.65	5.35	
FOR USE WITH					
007360					



REFERENCE MATERIALS

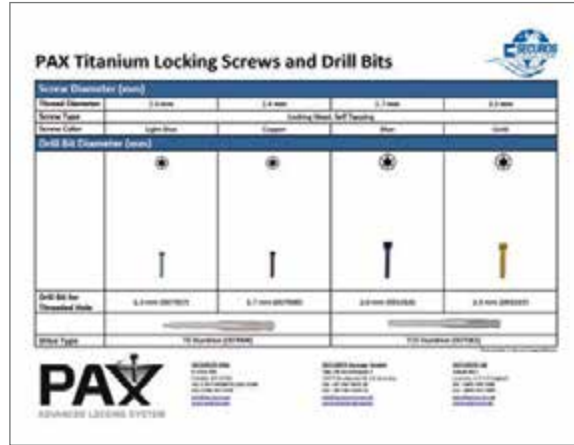

MWI#	SECUROS#	PRODUCT DESCRIPTION
■ 388991	004934	PAX Locking System Screw Reference



Top



Bottom

MWI#	SECUROS#	PRODUCT DESCRIPTION
048584	840920	Screw & Drill Bit Gauge

■ special order item



ORTHOPEDIC Biomaterials

Bone Graft.....	272
Velocity.....	273
Bone Cement.....	274
Veterinary Bone Cement.....	275



SECUROS Bioactive Synthetic Bone Graft

- **Osteostimulative** to accelerate natural bone healing
- **Osteoconductive** to induce rapid bone regeneration
- Immediate **ion release** to create ideal cellular environment
- Fully **resorbable** after 12 months
- Fully **synthetic** and available in **particulate** or **putty**



Within Minutes Exchange of Na ⁺ and H ⁺	1 Hour Loss of Na ⁺ initiates the release of soluble silica and the formation of surface silanol groups (Si-OH), which repolymerize into a silica-rich layer	6 Hours Precipitation of a layer of amorphous calcium phosphate	10 Hours Crystallization of a layer of hydroxyl carbonate apatite and growth from 1 to 10 days	20 Hours Absorption of biological compounds	24 Hours Action of macrophages	50 Hours Fixation of the stem cells	100 Hours Differentiation of the stem cells
---------------------------------------------------------------------	----------------------------------------------------------------------------------------------------------------------------------------------------------------------------------------	--------------------------------------------------------------------------	------------------------------------------------------------------------------------------------------------	------------------------------------------------------	--------------------------------------	-------------------------------------------	------------------------------------------------------

Velocity Ortho Particulate
(control) at 6 weeks

Velocity Ortho Putty
at 6 weeks

Velocity Ortho Particulate
(control) at 12 weeks

Velocity Ortho Putty
at 12 weeks



B = Formation of New Bone
V = Residual Velocity

Orthopedic Bioactive Synthetic Bone Graft (Sterile)

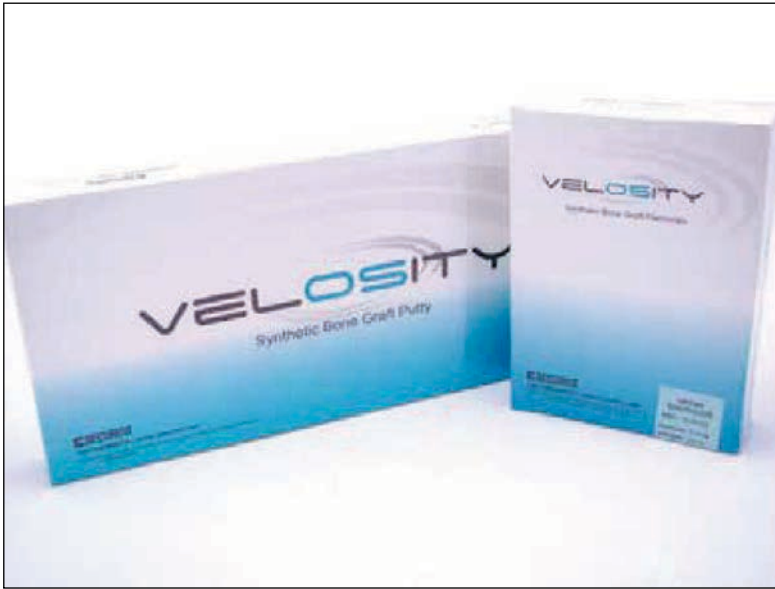

Putty Rolled in Hand



Applied to Bone

MWI#	SECUROS#	PRODUCT DESCRIPTION	VOLUME/BOX
035245	003756	Putty	2.5cc
032391	000842	Putty	5.0cc
032390	000841	Particulate	Two 2.5cc

Dental Bioactive Synthetic Bone Graft (Sterile)



Particulate

MWI#	SECUROS#	PRODUCT DESCRIPTION	VOLUME/BOX
042333	003623	Putty	1.0cc
032389	000840	Particulate	Two 2.5cc

20g
SECUROS G
Veterinary bone cement
with gentamicin

20g
SECUROS
Veterinary bone cement

Veterinary Bone Cement

- **Radiopaque** surgical bone cement available with or without **gentamicin**
- **Low viscosity** polymethyl methacrylate (PMMA)
- **Hardening** Time 8 –9 minutes
- For **applications** in Total Joint Replacement, Fracture Fixation and Cranioplasty



Veterinary Bone Cement



MWI#	SECUROS#	PRODUCT DESCRIPTION	VOLUME/BOX
046478	004882	Veterinary Bone Cement	20g
046479	004883	Veterinary Bone Cement with Gentamicin	20g

Instruments for Veterinary Bone Cement



MWI#	SECUROS#	PRODUCT DESCRIPTION
047218	005093	Mixing Bowl and Spatula



ORTHOPEDIC Specialty Instruments

Osteotomes	278
Chisels	279
Elevators	279
Smillie Cartilage Knives	281
Bone Holding Forceps	281
Patella Forceps	286
Bone Cutting Forceps	286
Mallets	289
Bone Tamps	290
Rasps	291
Rongeurs	292
Curettes	300
Gigli Saws	301
Michele Trephines	301
Dual Chuck Hand Chucks	302
Cast Spreaders	303
Sterilization Containers	303
Saw Blades	305

INSTRUMENTS

Osteotomes

MWI#	SECUROS#	WIDTH (mm)	LENGTH (")
Hoke Osteotomes - Straight			
			
045083	840683	3	5.5
045277	840247	4	5.5
045074	840248	6	5.5
045366	840684	8	5.5
045084	840685	10	5.5
048271	840926	12	5.5
045602	840249	13	5.5
049072	840250	16	5.5
049073	840251	19	5.5

MWI#	SECUROS#	WIDTH (mm)	LENGTH (")
Pedifine Lambotte Osteotomes - Straight			
			
045075	840252	2	5
045278	840253	3	5
042248	840254	4	5
045603	840255	6	5
049074	840256	7	5
045076	840257	8	5
049075	840258	9	5
045604	840259	10	5
045344	840260	12	5
049076	840261	15	5
049077	840262	19	5

MWI#	SECUROS#	WIDTH (mm)	LENGTH (")
Junior Lambotte Osteotomes - Straight			
			
045513	840263	4	7.25
045279	840264	5	7.25
045605	840265	6	7.25
055071	840266	7	7.25
045077	840267	9	7.25
045514	840268	10	7.25
048898	840269	12	7.25
048899	840270	16	7.25
048262	840271	19	7.25
049078	840272	22	7.25
049079	840273	25	7.25

MWI#	SECUROS#	WIDTH (mm)	LENGTH (")
Lambotte Osteotomes - Straight			
			
049080	840274	6	9
049081	840275	13	9
049082	840276	19	9
049083	840277	25	9
049084	840278	31	9
049085	840279	38	9

MWI#	SECUROS#	WIDTH (mm)	LENGTH (")
Lambotte Osteotomes - Curved			
			
049086	840280	6	9
049154	840281	13	9
049155	840282	19	9
049156	840283	25	9
049157	840284	31	9
049158	840285	38	9

Chisels

Hibbs Chisels - Straight



MWI#	SECUROS#	WIDTH (mm)	LENGTH (")
■ 370515	840836	6	9.5
048563	002309	12	9.5
045104	001683	25	9.5

Elevators

Freer Periosteal Elevators



MWI#	SECUROS#	FEATURE	LENGTH (")
042165	816520	Double Ended Sharp/Blunt	7.5

Key Periosteal Elevators - Sharp, Light Curve



MWI#	SECUROS#	WIDTH (mm)	LENGTH (")
■ 279527	840297	6	7.5
■ 276475	840298	13	7.5
■ 279258	840299	19	7.5
049180	840300	25	7.5

Adson Periosteal Elevators



840302

MWI#	SECUROS#	FEATURE	LENGTH (")
049181	840301	Blunt/Straight	6.75
045108	840302	Blunt/Curved	6.75
090027	840304	Semi-Sharp/Straight	6.75
090026	840303	Semi-Sharp/Curved	6.75

■ special order item

Elevators

AO Periosteal Elevators



840305

MWI#	SECUROS#	WIDTH (mm)	FEATURE	LENGTH (")
055009	001931	3	Straight, Flat Edge	7
055010	001932	6	Straight, Flat Edge	7
044993	840307	6	Curved, Round Edge	7.25
044895	840305	14	Straight, Round Edge	7.5
045280	840306	14	Curved, Round Edge	7.5
■ 279523	003764	19	Straight, Round Edge	7.5

Lane Periosteal Elevators



MWI#	SECUROS#	WIDTH (mm)	FEATURE	LENGTH (")
045335	840293	6	Narrow	6.5
049177	840294	10	Broad	6.5

Langenbeck Periosteal Elevators - Blunt Tip



MWI#	SECUROS#	WIDTH (mm)	FEATURE	LENGTH (")
049178	840295	7	Narrow	7
049179	840296	17	Broad	7

■ special order item

Smillie Cartilage Knives



840386



840388



MWI#	SECUROS#	FEATURE	LENGTH (")
045289	840386	Straight	6.5
045024	840388	Curved	6.5

Bone Holding Forceps

Raleigh Bone Clamp



MWI#	SECUROS#	FEATURE	LENGTH (")
045162	003273	Serrated Jaws	5.5

Lewin Bone Clamp



MWI#	SECUROS#	FEATURE	LENGTH (")
045080	840348	Serrated Jaws	7

Bone Holding Forceps

Lane Bone Clamps



MWI#	SECUROS#	FEATURE	LENGTH (")
049623	840323	Ratchet	13
■ 370196	840324	Ratchet	17

Kern Bone Clamps



With Ratchet

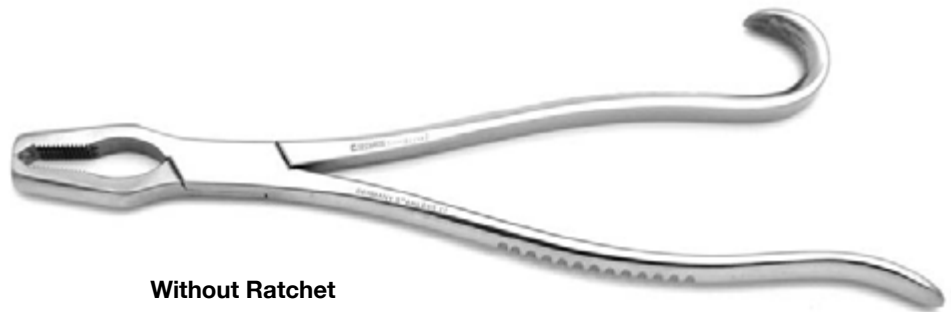

Without Ratchet

MWI#	SECUROS#	FEATURE	LENGTH (")
044998	840319	Ratchet	4.5
044999	840321	Ratchet	5.75
045236	816290	Ratchet	8.5
045285	840320	Ratchet	9.5
■ 279525	816411	Without Ratchet	5.75
045019	840322	Without Ratchet	8.5

■ special order item

Bone Holding Forceps

Verbrugge Bone Holding Forceps



MWI#	SECUROS#	FEATURE	LENGTH (")
049960	840336	Curved/Speedlock	5.5
049947	840337	Curved/Speedlock	6
090029	840338	Curved/Speedlock	7.5
049185	840339	Curved/Speedlock	9.5

Lambotte Bone Holding Forceps



MWI#	SECUROS#	FEATURE	LENGTH (")
049186	840340	Adjustable Jaws	8.75
049187	840341	Adjustable Jaws	10.5

Bone Holding Forceps

Lowman Bone Holding Forceps



MWI#	SECUROS#	FEATURE	LENGTH (")
045524	840325	1x2 Prong Jaw	5
049182	840326	1x2 Prong Jaw	7
039524	840327	1x2 Prong Jaw	8

Clamshell Bone Reduction Forceps

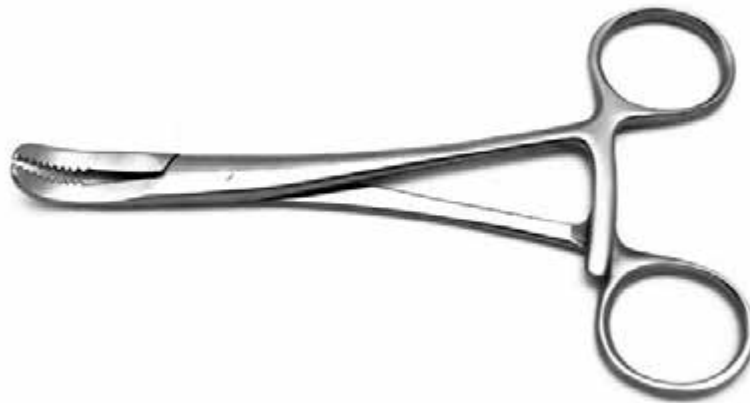

Curved Tips Ratchet Style



Clamshell with Speed Lock

MWI#	SECUROS#	FEATURE	LENGTH (")
049184	840334	Ratchet	5.5
090028	840335	Ratchet	6
045346	840328	Speedlock	6
043916	840329	Speedlock	7
045020	840330	Speedlock	8
■ 370195	840331	Speedlock	9
049653	840332	Speedlock	10.25
049654	840333	Speedlock	11

■ special order item

Bone Holding Forceps

Point-to-Point Bone Reduction Forceps

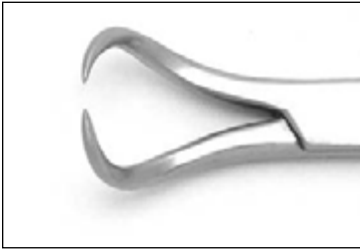

003277



840345



840346



MWI#	SECUROS#	FEATURE	LENGTH (")
055098	003277	Ratchet	3.5
035878	840345	Ratchet	5.5
045001	840346	Ratchet	8.5

Point-to-Point Bone Reduction Forceps with .035" Wire Guide



MWI#	SECUROS#	FEATURE	LENGTH (")
090030	840343	Curved	5
049207	840344	Curved	6.25

Patella Forceps



002163



840342



MWI#	SECUROS#	FEATURE	LENGTH (")
■ 370516	002163	Ratchet	5.75
049206	840342	2x2 Teeth/Speedlock	6.25

Bone Cutting Forceps

Liston Bone Cutting Forceps



Straight



Angled



MWI#	SECUROS#	FEATURE	LENGTH (")
045265	840213	Straight	5.5
090021	840214	Straight	7.5
090022	840215	Straight	8.75
090023	840218	Angled	5.5
045272	840219	Angled	7.5
049063	840220	Angled	8.75

■ special order item

Bone Cutting Forceps

Ruskin-Liston Bone Cutting Forceps

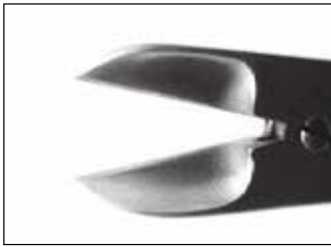

Straight



840216



Angled



840217

MWI#	SECUROS#	FEATURE	LENGTH (")
045267	840216	Straight	7.5
045341	840217	Angled	7.5

Bohler Bone Cutting Forceps



MWI#	SECUROS#	FEATURE	LENGTH (")
045174	003677	Straight	5.75

Bone Cutting Forceps

Cleveland Bone Cutting Forceps

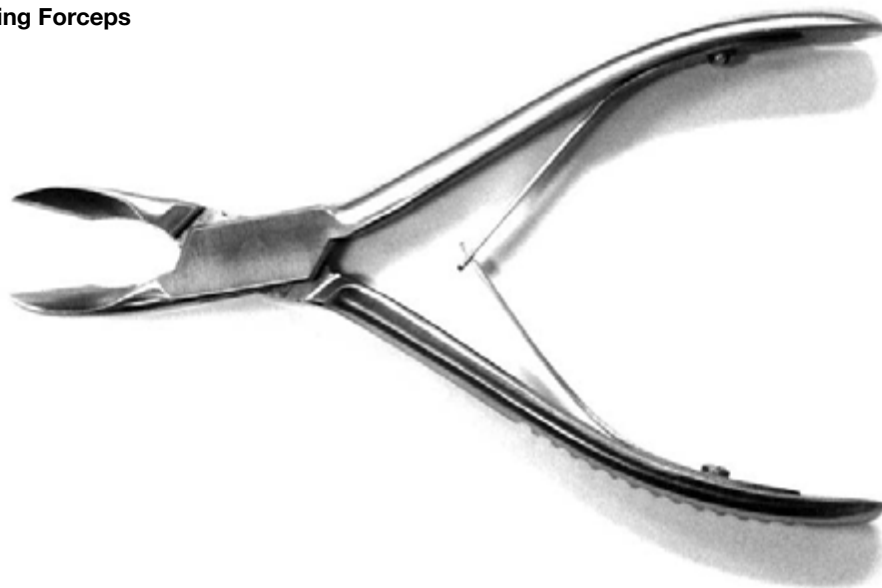

MWI#	SECUROS#	FEATURE	LENGTH (")
■ 370197	003676	Curved	6

Stille-Liston Bone Cutting Forceps



MWI#	SECUROS#	FEATURE	LENGTH (")
■ 370198	003678	Straight	10.5

■ special order item

Mallets



840400



813670



840399



840401

MWI#	SECUROS#	PRODUCT DESCRIPTION	HEAD DIAMETER (")	WEIGHT (g)	LENGTH (")
048375	840400	Lucae Mallet	1	250	7.5
042163	813670	Mead Mallet (Includes Replacement Plastic Facings)	1	320	7.5
049220	840398	Replacement Plastic Facings for Mead Mallet (2 Pack)	-	-	-
045003	840399	Gerzog Hammer - Lead Filled	1	230	7.5
049221	840401	Combo Mallet	1	230	7.5

Bone Tamps



MWI#	SECUROS#	DIAMETER (mm)	LENGTH (")
090033	840363	3	6.25
045021	840364	5	6.25
049209	840365	7	6.25
090070	840366	9	6.25

Rasps



840352

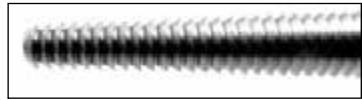

840358



840355



840356



840357



003029



840353



840354

MWI#	SECUROS#	PRODUCT DESCRIPTION	WIDTH (mm)	LENGTH (")
036188	840352	Fomon Rasp	8	8.5
046143	840358	Trochlear Groove Rasp	8	7
090032	840355	Lewis Rasp	8	7
045523	840356	Aufricht Rasp	8.5	8
090069	840357	Cottle Rasp	8	8.25
048155	003029	Maltz Cottle Nasal Rasp - Down Cutting	7	7
045347	840353	Putti Bone Rasp - Double Ended Flat Blades	18	10.5
049208	840354	Putti Bone Rasp - Double Ended Round & Flat Blades	10, 15	12

Rongeurs

Micro Friedman Rongeur



MWI#	SECUROS#	SIZE	LENGTH (")
044065	840221	1.3x10mm Bite/Curved	5.5

Lempert Rongeurs



Straight



Curved

MWI#	SECUROS#	SIZE	LENGTH (")
044055	840222	2.5x10mm Bite/Straight	6.5
042162	810580	2.5x10mm Bite/Curved	6.5

Adson Rongeur



MWI#	SECUROS#	SIZE	LENGTH (")
■ 370194	840223	8x16mm Bite/Straight	8

■ special order item

Rongeurs

Dean Rongeur



MWI#	SECUROS#	SIZE	LENGTH (")
045273	840224	3x11mm Bite/Curved	5.75

Luer Rongeurs

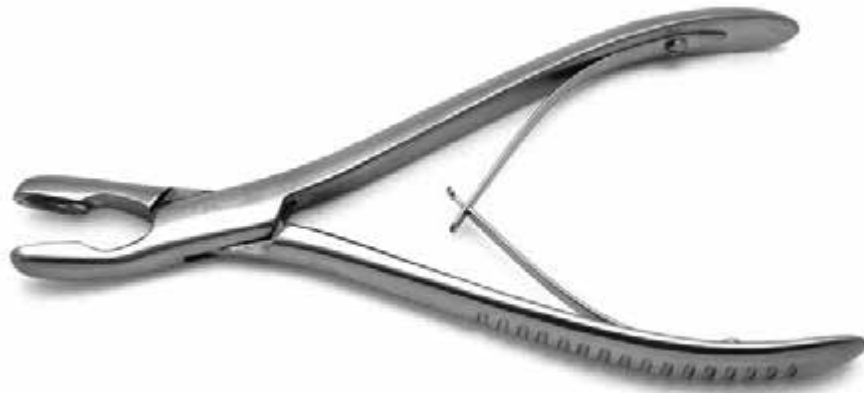

Curved

MWI#	SECUROS#	SIZE	LENGTH (")
■ 370226	840225	8x10mm Bite/Straight	7
045274	840226	8x10mm Bite/Curved	7

Rongeurs

Ruskin Rongeurs



Straight

MWI#	SECUROS#	SIZE	LENGTH (")
044990	840227	3x10mm Bite/Curved	6
045073	840228	4x15mm Bite/Straight	7.25
045342	840229	4x15mm Bite/Curved	7.25

Beyer-Stille Rongeur



MWI#	SECUROS#	SIZE	LENGTH (")
055019	840230	4x15mm Bite/Curved	7

Rongeurs

Echlin Rongeurs



MWI#	SECUROS#	SIZE	LENGTH (")
049064	840231	2x15mm Bite/Angular (Duckbill)	9
049065	840232	3x15mm Bite/Angular (Duckbill)	9
049066	840233	4x15mm Bite/Angular (Duckbill)	9

Leksell Rongeurs



MWI#	SECUROS#	SIZE	LENGTH (")
049067	840235	4x16mm Bite/Angled	9
045343	840234	7x16mm Bite/Angled	9

Rongeurs

Stille-Luer Rongeurs



Curved



MWI#	SECUROS#	SIZE	LENGTH (")
■ 370234	840236	9x15mm Bite/Straight	8.5
049068	840237	9x15mm Bite/Curved	8.5

Rongeurs

Kerrison Rongeurs



Up-Angle



Up-Bite



Down-Bite



MWI#	SECUROS#	WIDTH (mm)	FEATURE	LENGTH (")
045601	840240	1	40 Degree Up-Angle	7
■ 370517	840937	2	40 Degree Up-Angle	7
044992	840241	3	40 Degree Up-Angle	7
■ 370518	840938	4	40 Degree Up-Angle	7
■ 370519	840939	5	40 Degree Up-Angle	7
■ 370520	840940	6	40 Degree Up-Angle	7
045275	840238	1	Up-Bite	7
044991	840239	2	Up-Bite	7
■ 276422	003047	3	Up-Bite	7
■ 370521	840941	4	Up-Bite	7
■ 370522	840942	5	Up-Bite	7
■ 370523	840943	6	Up-Bite	7
■ 370524	840944	2	Down-Bite	7
■ 370525	840945	3	Down-Bite	7
■ 370526	840946	4	Down-Bite	7
■ 370527	840947	5	Down-Bite	7
■ 370528	840948	6	Down-Bite	7

■ special order item

Rongeurs

Ferris-Smith Rongeurs



Straight



Up-Angle



Down-Angle



MWI#	SECUROS#	SIZE	LENGTH (")
■ 370235	840242	2x10mm Bite, Straight	7
■ 279526	840243	3x10mm Bite, Straight	7
045276	840244	2x10mm Bite, Up-Angle	7
049069	840245	3x10mm Bite, Up-Angle	7
049070	840246	2x10mm Bite, Down-Angle	7

Wilde Ethmoid Rongeur



MWI#	SECUROS#	SIZE	LENGTH (")
045498	004228	4mm Fenestrated Jaw, Straight	5.5

■ special order item

Rongeurs

Peapod Rongeurs



MWI#	SECUROS#	SIZE	LENGTH (")
■ 370534	004226	3x6mm Bite, Up-Angle	5.5
■ 370534	004227	3x6mm Bite, Straight	4.75

Schlesinger Rongeurs

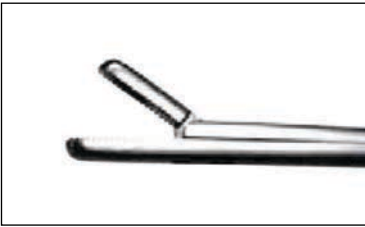

MWI#	SECUROS#	SIZE	LENGTH (")
■ 370535	004230	3x10mm Serrated Bite, Straight	5.5
■ 370536	004231	4x10mm Serrated Bite, Straight	5.5

Takahashi Rongeur

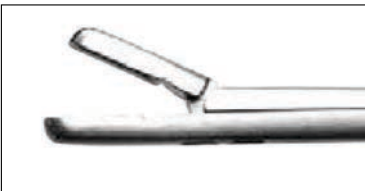

MWI#	SECUROS#	SIZE	LENGTH (")
■ 370537	004229	2.5x10mm Bite, Straight	4.75

■ special order item

Rongeurs

Caspar Rongeur



MWI#	SECUROS#	PRODUCT DESCRIPTION	LENGTH (")
■ 370546	005507	2x10mm Bite, Straight	6.25

Curettes

Bruns Curettes



MWI#	SECUROS#	SIZE	FEATURE	LENGTH (")
045336	840308	00000	Oval Cup	7
045337	840309	0000	Oval Cup	7
044994	840310	000	Oval Cup	7
044997	840311	00	Oval Cup	7
045079	840312	0	Oval Cup	7
045338	840313	1	Oval Cup	7
045282	840314	2	Oval Cup	7
044996	840315	3	Oval Cup	7
045339	840316	4	Oval Cup	7
045340	840317	5	Oval Cup	7
045345	840318	6	Oval Cup	7

■ special order item

Gigli Saws

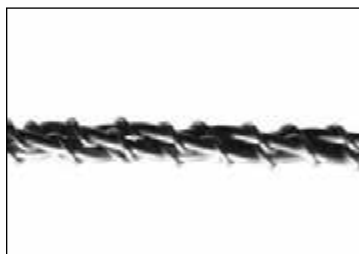

MWI#	SECUROS#	PRODUCT DESCRIPTION	LENGTH (")
045002	840349	Gigli Wire	12
036661	840350	Gigli Wire	20
045286	840351	Gigli Saw Handles, Set of 2	-

Michele Trephines

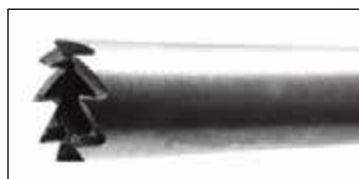

MWI#	SECUROS#	OUTER DIAMETER (mm)	LENGTH (")
049218	840395	5	6.25
049219	840396	6	6.25
045439	840397	8	6.25

Dual Chuck Hand Chucks



001480



001479

MWI#	SECUROS#	PRODUCT DESCRIPTION	MAXIMUM PIN DIAMETER (")	LENGTH (")
029519	001480	Mini Dual Chuck Hand Chuck	5/32	5.75
029517	001479	Dual Chuck Hand Chuck	1/4	6.5

Dual Chuck Hand Chuck Keys & Extension Handle



002988



001482



005015

MWI#	SECUROS#	PRODUCT DESCRIPTION	LENGTH (")
■ 370236	002988	Replacement Key for Mini Dual Chuck Hand Chuck	1.75
029521	001482	Replacement Key for Dual Chuck Hand Chuck	2
047958	005015	Jacobs Chuck Key Extension Handle	5.5

■ special order item

Cast Spreaders



003013



003012

MWI#	SECUROS#	PRODUCT DESCRIPTION	LENGTH (")
■ 370237	003013	Beeson Cast Spreader	12
031782	003012	Hermann Cast Spreader	19

STERILIZATION CONTAINERS

Stainless Steel Cases



003749



002751



840870

MWI#	SECUROS#	PRODUCT DESCRIPTION	LENGTH (")	WIDTH (")	HEIGHT (")
■ 370529	004421	Stainless Steel Case	6.5	5.5	0.5
044048	003749	Stainless Steel Case with Silicone Mat	15	8.5	1.25
045620	002751	Stainless Steel Case with Silicone Mat	8	4.75	1.25
048843	840870	Universal Dental Tray Stainless Steel, Includes Rubber Holders	11.5	7	1.5

■ special order item

STERILIZATION CONTAINERS

Plastic Cases (Includes Silicone Mat)



840770

001330

001332

001331

MWI#	SECUROS#	LENGTH (")	WIDTH (")	HEIGHT (")
■ 276469	004176	7	2	.75
048833	840770	7.75	4.25	1
043918	001330	11.25	6.75	2
045114	001332	15	10	2.5
045434	001331	20.75	10	2.5

Stainless Steel Perforated Trays



MWI#	SECUROS#	LENGTH (")	WIDTH (")	HEIGHT (")
031093	001005	12.25	7.75	2.25
042046	000513	10	6.5	2
045520	001350	9	5	2

Silicone Mat

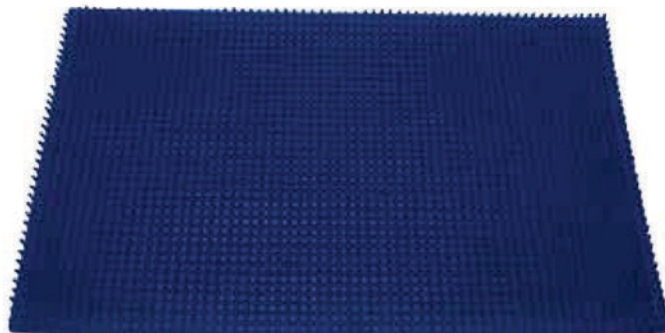

MWI#	SECUROS#	PRODUCT DESCRIPTION	LENGTH (")	WIDTH (")
044060	003760	Silicone Mat Cut to Size	15.5	9.25

■ special order item

SAW BLADES

Oscillating Saw Blades



MicroAire Oscillating/Sagittal Saw Blades-Also fits Stryker Command 2 & TPS

MWI#	SECUROS#	WIDTH (mm)	USABLE LENGTH (mm)	MATERIAL THICKNESS (mm)
048503	000615	5.5	18.0	0.38
045011	000616	6.6	18.5	0.38
045096	000611	7.0	15.0	0.38
045179	003813	7.0	29.5	0.40
045095	000606	9.0	10.0	0.38
055005	000613	9.1	18.5	0.38
055083	000614	13.0	34.5	0.38
048180	003241	13.0	39.0	0.40
042052	000612	16.5	34.5	0.38
055006	000610	16.8	18.5	0.38

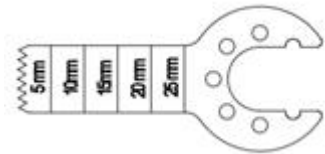

AO/Synthes Oscillating/Sagittal Saw Blades

MWI#	SECUROS#	WIDTH (mm)	USABLE LENGTH (mm)	MATERIAL THICKNESS (mm)
055023	003454	6.0	30.0	0.40
042324	003455	10.0	26.0	0.40
045629	003458	13.0	95.0	0.89
055022	003457	14.0	52.0	0.40



3M Mini Driver Sagittal Saw Blade

MWI#	SECUROS#	WIDTH (mm)	USABLE LENGTH (mm)	MATERIAL THICKNESS (mm)
055048	003659	9.5	30.0	0.64
■ 276666	003660	10.0	10.0	0.68
045552	003622	15.5	10.0	0.68

■ special order item



SURGICAL Instrument Care

Warranty Information	308
Cleaning & Sterilization	310
Troubleshooting	311
Repair Information	314
ColorDot®	316
Detailed Instrument Inspection.....	317
Cleaners.....	320

Prolonging the life of your SECUROS Surgical Instrument

Implementing a preventative maintenance program for your surgical instruments has never been easier. SECUROS Surgical is proud to offer **FREE Sharpening Repair Service on all SECUROS Surgical Instruments.*** Preventative maintenance of your surgical instruments will not only allow you to perform better surgery, but will also extend the life of your surgical instruments.

*SECUROS Surgical's instrument repair services include inspection, scissor sharpening, orthopedic instrument sharpening, alignment of jaws and tips, complete instrument refurbishing, lubrication, and re-taping. Does not include TC jaw replacement. The FREE services apply to the entire SECUROS Surgical Instrument line.

The instruments will be serviced at SECUROS' National Repair Center by our German-trained instrument technicians. Our advanced repair center has the ability to fully service all of your instrument repair and servicing needs.

Please contact a SECUROS Surgical sales specialist at (877) 266-3349 to find out more about this exciting service.



Warranty Information

SECUROS guarantees that any surgical instrument will be free of defects in materials and workmanship, when used under normal conditions for its intended surgical purpose. In the event that an instrument is defective, SECUROS will at its sole option either repair or replace the instrument.

Many of the instruments manufactured by SECUROS are hand-finished by skilled craftsmen. Consequently, there may be slight variations in the dimensions of an instrument from those given in the listed specifications.

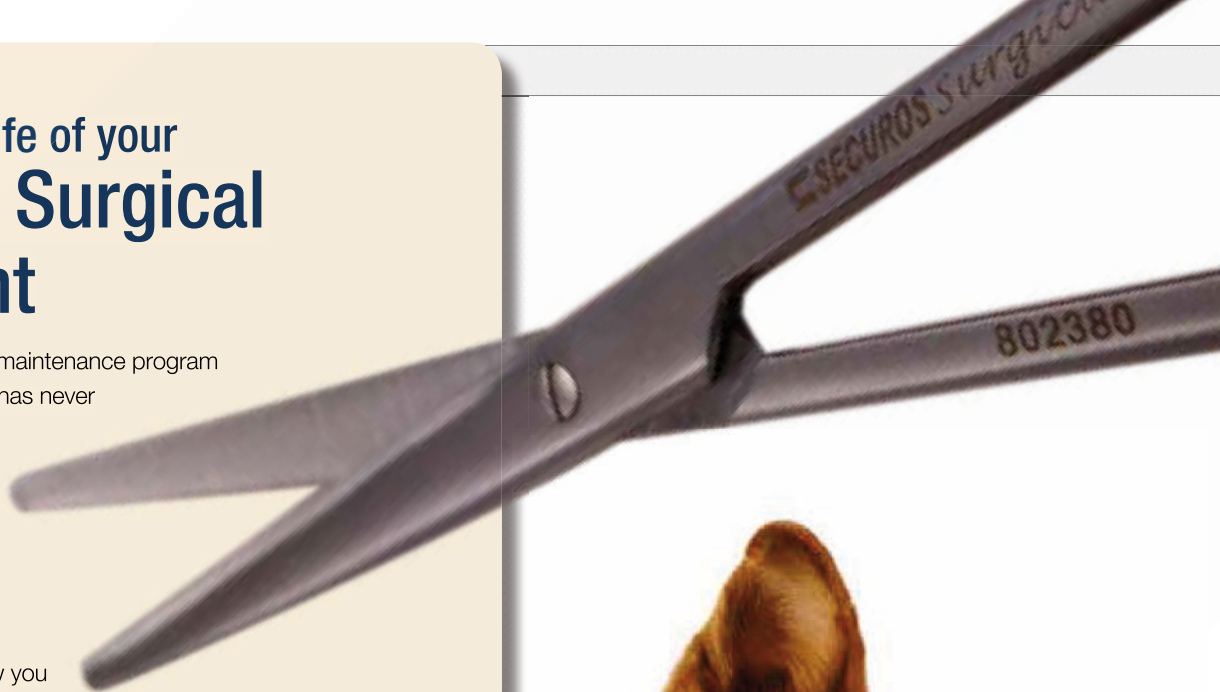

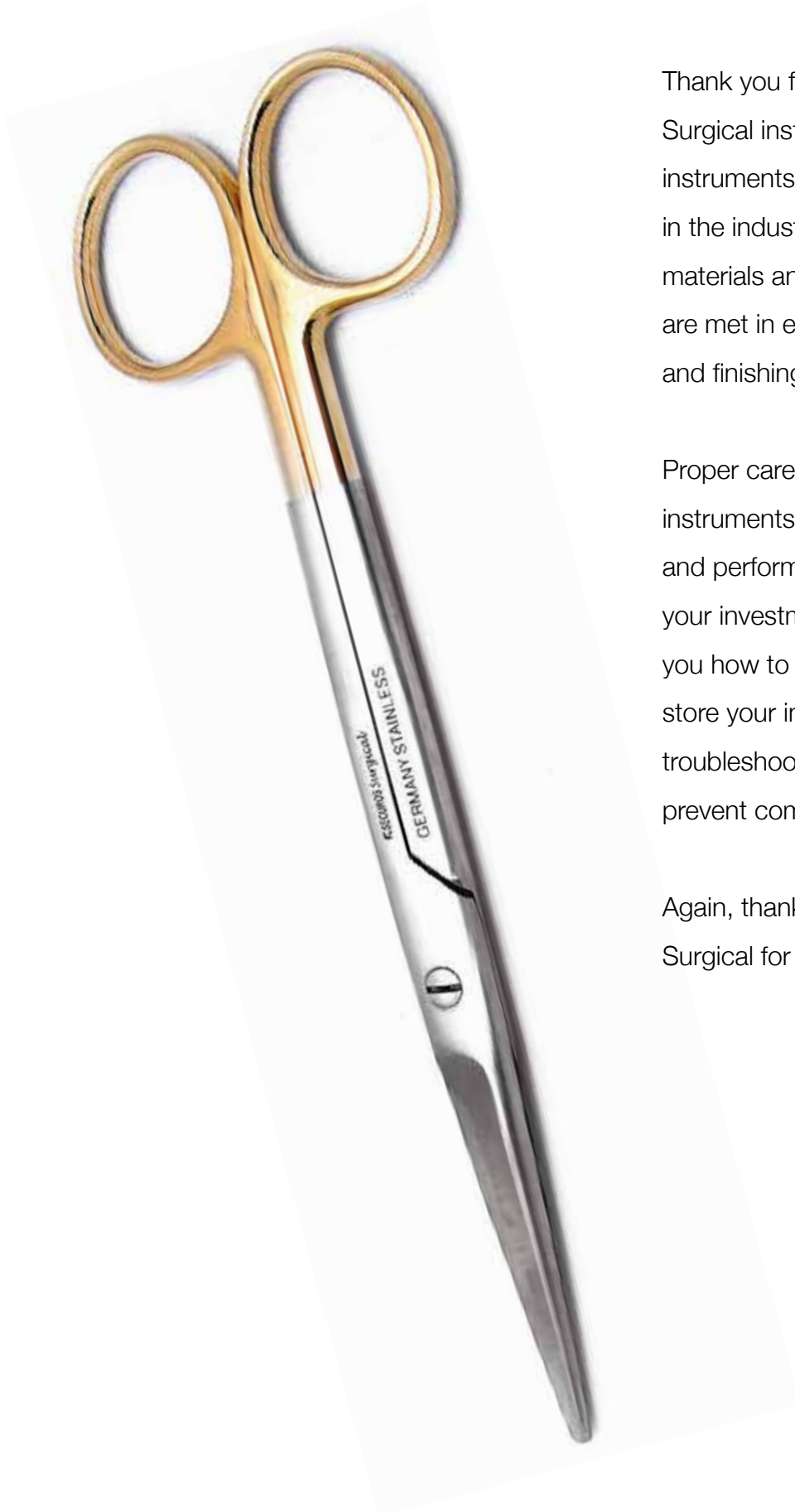

Thank you for your purchase of SECUROS Surgical instruments. We believe that our instruments are the highest quality available in the industry. We start with the best raw materials and ensure that precise standards are met in every step of the manufacturing and finishing process.

Proper care and handling of your instruments will make them last longer and perform better, thus maximizing your investment. This guide will show you how to properly clean, sterilize and store your instruments, as well as provide troubleshooting tips to help you identify and prevent common instrument stains.

Again, thank you for choosing SECUROS Surgical for your instrument needs.

Manual Cleaning

These are the key steps for manual cleaning:

- Immediately after use, soak instruments in warm water and rinse off all visible bio-burden (blood, tissue, etc.)
- After rinsing, place instruments in Manual & Ultrasonic Instrument Cleaner. Use fresh cleaning solution for each new batch of instruments.
- If rinsing is not immediately available, spray on SECUROS Enzymatic Foam Instrument Cleaner. This will keep the instruments moist and break down bio-burden until they can be cleaned.
- Use a soft nylon brush to scrub delicate instruments.
- After disinfecting, rinse the instruments again: first with tap water then with distilled water.
- Dry all instruments immediately after rinsing and place them on a dry surgical towel.

Recommended product: Manual & Ultrasonic Instrument Cleaner, 1 gallon. Enzymatic Foam Instrument Cleaner, 32 oz.

Lubrication

These are the key steps for instrument lubrication:

- Lubricate all instruments with a box lock (i.e., hinged) with Instrument Spray Lubricant.
- Spray lubricant onto clean surgical instruments.
- Wipe excess lube, then place in a pouch or wrap for sterilization.

Recommended product: Instrument Spray Lubricant, 8 fl. oz.

Sterilization

These are the key steps for sterilizing instruments in an autoclave:

- Lubricate all instruments with a box lock (i.e., hinged) with Instrument Spray Lubricant.
- Do not stack instruments on top of one another or overload the sterilizer, because this will cause excessive condensation and possible spotting on the instruments.
- Place each instrument in its own pouch, with the ratchet in the open position, and lean the pouches against the chamber wall.

Recommended product: Instrument Spray Lubricant, 8 fl. oz.

Ultrasonic Cleaning (if applicable)

These are the key steps for processing instruments in an ultrasonic cleaner:

- Immediately after use, soak instruments in warm water and rinse off all visible bio-burden. Then place instruments into the cleaner.
- Place each hinged instrument in the cleaner with the ratchet in the open position. This will result in a cleaner instrument and preserve the integrity of the box lock.
- Fully submerge all instruments, but do not overload the cleaner.
- Place only like metal instruments together in the cleaner (e.g. do not put chrome-plated instrument in with stainless steel instruments).
- When the cleaning cycle is complete, immediately remove the instruments, and rinse them with distilled water.
- Dry all instruments immediately after rinsing and place them on a dry surgical towel.

Recommended product: Manual & Ultrasonic Instrument Cleaner, 1 gallon

Inspection

- Visually inspect all surfaces of the instruments for stains, cracks, or chips.
- Test sharps on gauze or latex material for proper cutting action.
- Needle holders and hemostats should engage properly and meet correctly at the tips.

Storage

- Store instruments in a climate-controlled area.
- Do not store instruments near chemicals that may emit a vapor.
- Ensure that all instruments are completely dry before storing them.

Troubleshooting

A variety of stains or spotting might appear on your instruments after the cleaning and sterilization processes are completed. Most likely, these are not rust, but rather an indication of improper cleaning or sterilizing procedures. The following chart can help you identify and prevent or remove many of stains that typically show up on instruments.

STAIN/SPOT COLOR	POSSIBLE CAUSES	SOLUTIONS
Brown/Orange	Bio-burden (tissue, blood, etc.) left on instrument	Use an eraser to rub off stain
	Detergent pH is too high (>8)	Choose a cleaning solution with a neutral pH
	Soap/detergent residue on drapes/towels used in wrapping	Review laundry protocol to improve soap-free rinse
Rust	Mixing instruments made of different metals in the same cleaning or sterilizing cycle	Separate instruments by metal type for cleaning and sterilization
	Tap water has high mineral content	Use distilled water and thoroughly dry instruments after rinsing
Black/Brown, with pitting	Cold soaking of instruments	Eliminate cold soaking and potential exposure to chemicals during that process
	Detergent pH is too low (<6)	Choose a cleaning solution with a neutral pH
Blue/Black	Mixing instruments made of different metals in the same cleaning or sterilizing cycle	Separate instruments by metal type for cleaning and sterilization
Blue/Gray	Improper cold sterilization	Check solution instructions and follow recommended temperature and soak times
	Chemical or mineral residue	Use distilled water and thoroughly dry instruments after rinsing
Spotting	Slow or improper drying of instruments	Review autoclave manufacturer's instructions
	Mineral residue	Use distilled water and thoroughly dry instruments after rinsing
Multi-Color	Excessive heat during sterilizing cycle*	Review autoclave instructions

*CAUTION: Instrument may be permanently compromised due to loss of tensile strength.

Brown/Orange Staining



Rust



Appearance

- Brown or orange stains

Causes

- Long interval between instrument use and processing, allowing bio-burden to dry
- Unsuitable instrument disinfectant (pH is too high)
- Contaminated towels/drapes
- Overloading autoclave

Treatment

- Use an eraser to rub off the stain, or use SECUROS Stain Remover
- Targeted manual recleaning

Prevention

- Remove bio-burden from instruments immediately after use, process within 15 minutes after surgery
- Soak and clean instruments with Manual & Ultrasonic Instrument Cleaner
- Use a longer rinse cycle for towels/drapes to remove laundry soap residue
- Avoid overloading autoclave which could result in excess condensation

Appearance

- Brown spots or streaks
- Possible pitting under the discoloration

Causes

- Mixing different metals in the same cleaning or sterilizing cycle
- Using water with a high mineral content in the cleaning process

Treatment

- Use a brush and instrument stain remover with distilled water to scrub away spots

Prevention

- Separate instruments by metal type
- Use distilled water throughout the cleaning/sterilizing process
- Avoid overloading autoclave which could result in excess condensation

Pitting With Discoloration



Appearance

- Pinprick-like holes in stainless steel, frequently surrounded by microscopic sparkling, reddish brown or multi-color corrosion spots
- Minor-quality instrument steels might contain material-specific cavities or foreign-matter inclusions—these may resemble pitting, but they are not caused by the cleaning process

Causes

- Exposure to halide ions, especially chlorides that break through the passive layer of instrument steel
- Exposure to liquids with a high chloride content (i.e. bleach or high chloride levels in the final rinse water)
- Exposure to saline solutions
- Contact corrosion might occur when different metals are mixed, (titanium and stainless steel)

Treatment

- SECUROS can clean the instrument with an acid-based cleaner
- SECUROS might be able to treat corrosion holes mechanically

Prevention

- Use distilled water throughout the cleaning/sterilizing process
- Minimize instrument exposure to other liquids containing chlorides
- Separate instruments by metal type

Spotting

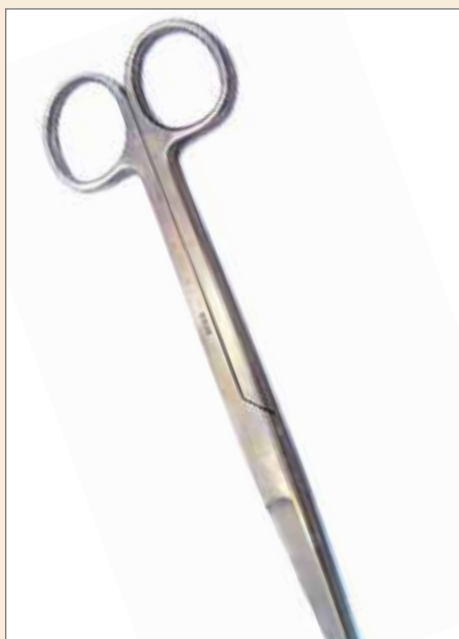

Appearance

- Milky white to gray stains
- The stains may extend across a large surface area or be irregular, sharply defined spots

Cause

- Using water with a high lime or mineral content in the cleaning process
- Stacking instruments on top of each other in autoclave
- Overloading autoclave

Treatment

- Wipe off with a soft cloth
- SECUROS can clean the instruments with an acid-based cleaner

Prevention

- Use distilled water for the final rinse, manual cleaning, and ultrasonic cleaning
- Review autoclave manufacturer's instructions
- Avoid overloading autoclave which could result in excess condensation

Sharpening & Resurfacing

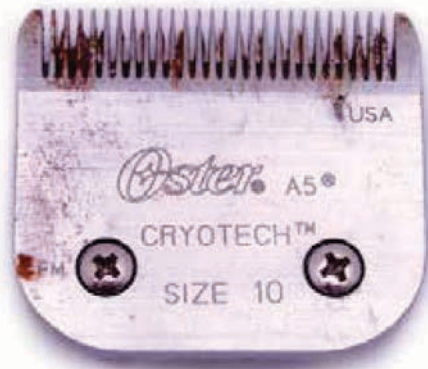

Before



After

Clipper Blade Sharpening

Clipper blades can be sent to SECUROS for sharpening.

1. Clean all blades prior to shipping.
2. Wrap the blades with extra padding to cover the tips, and carefully pack them in a box to prevent damage in shipping.
3. Fill out the [SECUROS Instrument Work Order](#) form online or fax it to SECUROS Customer Service for a Return Authorization #.
4. Include a copy of the completed [SECUROS Instrument Work Order](#), with the return authorization number, in the shipping box.

*The sharpened blades will be returned to you within 5 – 7 business days (upon receipt).

*Blades that arrive at SECUROS with broken teeth will not be repaired. SECUROS is not responsible for any damages that occur during shipping.



Repair Information

- SECUROS repairs all brands, all makes and all models of surgical instruments.
- If sending in multiple instruments, label each instrument for the desired service.
- Any non-warranty instrument repairs are subject to the service charges.
- Instruments damaged beyond normal wear and tear may have additional repair costs. A SECUROS Representative will call you to discuss these options if necessary.
- Upon receipt at SECUROS, expect 5-7 days turnaround time, unless otherwise specified.

Non-Warranty Repairs

Instrument Description
Sharpening: Scissors All Sizes
Sharpening: Dental Elevators
Sharpening: Clipper Blades
Sharpening: Osteotome/Chisel
Sharpening: Rongeur
Realignment
Refinishing
Replacement Inserts: Needle Holder
Replacement Screw
ColorDot (color-coded permanent plugs)**
Other (To be determined)

* Turnaround time, upon receipt at SECUROS is 5-7 business days

** Please designate color choice on tag: white/red/orange/yellow/green/blue/purple/brown/black/pink/light blue

Express services available for additional charge. Contact repairs at securos.com for additional information.

For repair service charges please go to:

www.securos.com/repairservice.aspx, call 1-877-266-3349 or email repairs@securos.com.



Instrument Shipping Requirements

1. Clean and sterilize all instruments prior to shipping. (OSHA regulations require all instruments be shipping in sterilized pouches).
2. Wrap any sharp instruments with extra padding to prevent damage in shipping.
3. Individually wrap all clipper blades to ensure they don't break during shipping.
4. Fill out the [SECUROS Instrument Work Order](#) form online or fax it to SECUROS Customer Service for a Return Authorization #.
5. Include a copy of the completed [SECUROS Instrument Work Order](#) form, with the return authorization number, in the shipping box.

The instruments will be returned to you within 5-7 business days (upon receipt).



ColorDot®

Instrument Marking System

The SECUROS ColorDot® surgical instrument color marking system is a breakthrough technology that provides permanent and safe marking of surgical instrument packs. The ColorDot® marking plugs are manufactured from a composite ceramic material and are available exclusively through SECUROS Surgical. The SECUROS ColorDot® Instrument Marking System replaces the need for instrument tape and traditional instrument color coding or dipping. While instrument tape fades or comes off after time, and traditional color coding systems crack and breakdown after repeated autoclaving, the SECUROS ColorDot® Instrument Marking System is guaranteed to last for the entire life of the instrument.

The ColorDot® color dots are implanted using a specialty press and have proven to be a great method for identifying surgical packs. The SECUROS ColorDot® Instrument Marking System is available in 11 colors providing customers with many choices and color combinations to mark their instrument packs.

The colors available include:

- White
- Red
- Orange
- Yellow
- Green
- Blue
- Purple
- Brown
- Black
- Pink
- Light Blue

The SECUROS ColorDot® Instrument Marking System can be placed in all makes and models of instruments for a minimal charge. To utilize the service, send your packs to SECUROS Surgical's National Repair Center located at:

SECUROS REPAIR CENTER

443 Main St.

P.O. Box 950

Fiskdale, MA 01518

Please use the Instrument Work Order Form online and request a return authorization # prior to sending.

When purchasing new packs or instruments directly from SECUROS or MWI, be sure to request the SECUROS ColorDot® Instrument Marking System be implemented on all of your new instruments.



Detailed Instrument Inspection

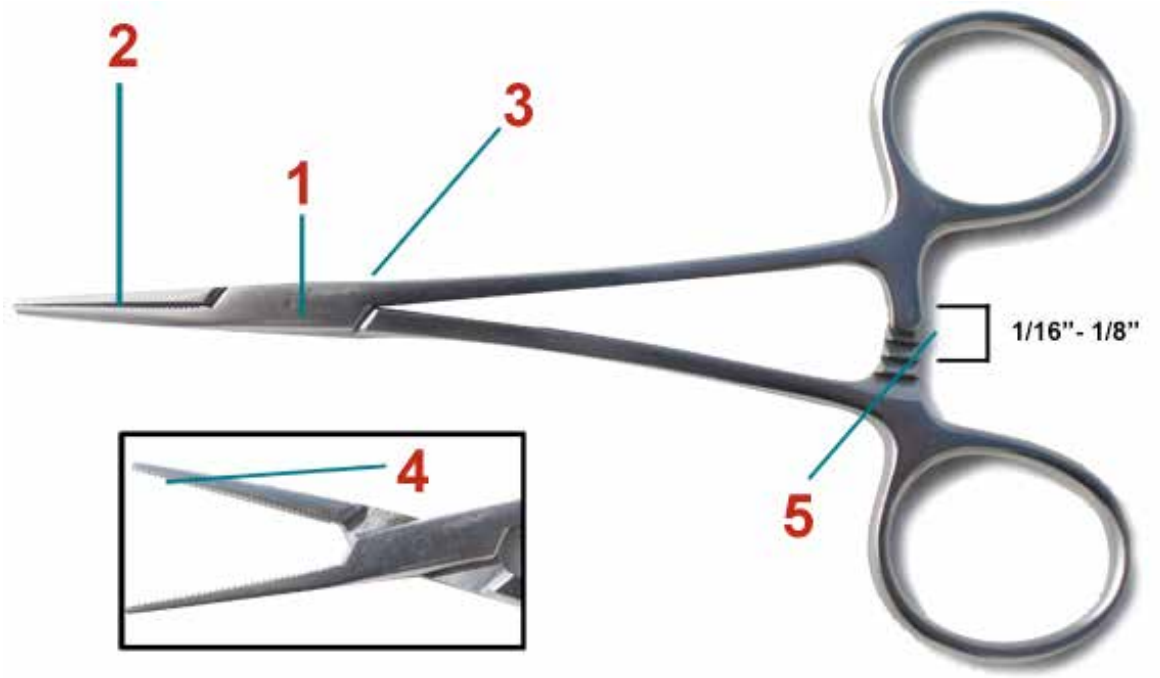

Forceps

1) Cracked Box Lock

- Inspect box lock closely for cracks. Cracks reduce the integrity of the instrument.
- Visible cracks cannot be repaired.

2) Jaw Alignment

- Standard or hemostat forceps: Securely close the instrument and inspect the jaw alignment.
- Forceps with teeth: open and close the instrument to feel if the teeth are engaging each other.
- Misaligned jaws can be repaired.

3) Loose Box Lock

- Open the instrument and hold one ring handle in each hand. Gently move one handle up and down; there should be minor movement in the box lock, but it should not be loose.
- A loose box lock can be repaired.

4) Worn Serrations or Broken Teeth

- Inspect the jaws for worn serrations or broken teeth.
- Forceps with worn serrations or broken teeth cannot be repaired.

5) Ratchet Fit

- The instrument should stay tightly locked and properly aligned in the first ratchet position. Closed jaws should have $1/16''$ to $1/8''$ of space between the ratchets to maintain proper tension.
- Misaligned ratchets can be repaired.

For best results, send damaged and malfunctioning instruments to SECUROS as soon as possible. Please call or fax the Instrument Work Order Form for return authorization, or use the online form.

Detailed Instrument Inspection

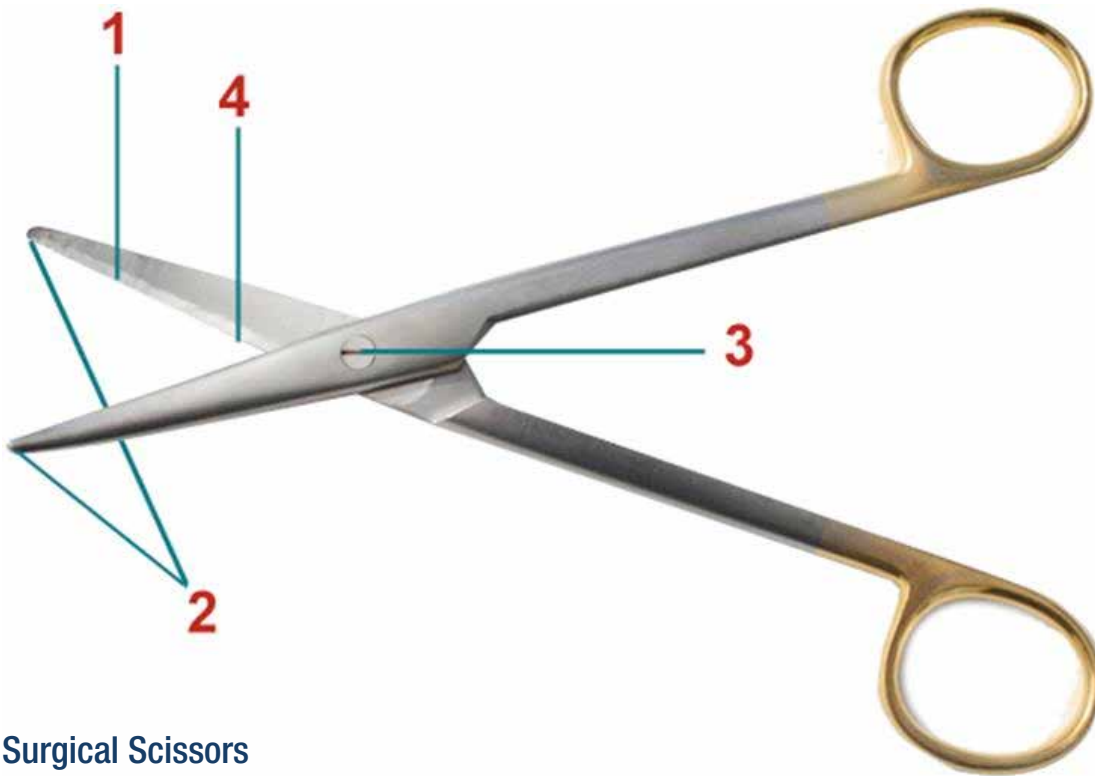

Surgical Scissors

1) Chips, Pitting or Cracks

- Inspect the scissors' cutting edge for any nicks or "holes" from pitting.
- Scissors with these defects cannot be repaired.
- Scissors with vertical cracks through the cutting edge cannot be repaired.

2) Bent or Broken Tips

- Open and close the instrument. Bent tips will rub noticeably at the tip.
- Bent tips can be repaired.
- Broken tips cannot be repaired.

3) Loose or Worn Screw

- A loose or worn screw will make the scissors feel "sloppy" and the cutting edges will not pass together properly.
- A small crack could develop close to the screw.
- A cracked, loose, or worn screw can be repaired.

4) Dull Cutting Edge

- Cut one layer of gauze or latex material with the front 1/3 of the blades.
- Scissors should be sharpened if they require force to cut the material or the tips get caught.

For best results, send damaged and malfunctioning instruments to SECUROS as soon as possible.

Please call or fax the Instrument Work Order Form for return authorization, or use the online form.

Detailed Instrument Inspection

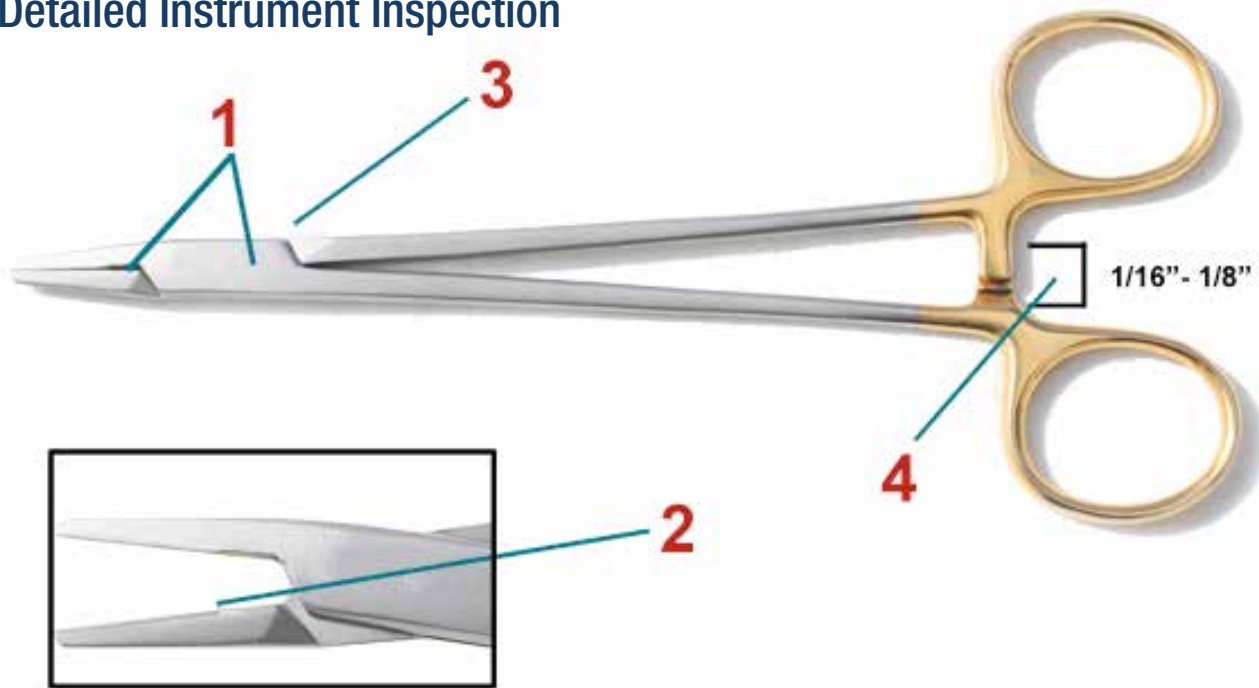

Tungsten Carbide Needle Holder

1) Cracked Box Lock

- Inspect box lock closely for cracks. Cracks reduce the integrity of the instrument.
- Visible cracks cannot be repaired.

2) Cracked Jaws/Cracked or Worn Inserts

- A crack in the jaw appears with a distinct bend with a clear break behind the insert.
- Cracked jaws can be repaired.
- Close the instrument and hold it up to a light. If light is passing between the insert, the instrument needs to be repaired.
- A cracked or worn insert can be replaced.



Signs of wear of the tungsten carbide insert necessitating repair.

3) Loose Box Lock

- Open the instrument and hold one ring handle in each hand. Gently move one handle up and down; there should be minor movement in the box lock, but it should not be loose.
- A loose box lock can be repaired.

4) Ratchet Fit

- The instrument should stay tightly locked and properly aligned in the first ratchet position. Closed jaws should have 1/16" to 1/8" of space between the ratchets to maintain proper tension.
- Misaligned ratchets can be repaired.

For best results, send damaged and malfunctioning instruments to SECUROS as soon as possible. Please call or fax the Instrument Work Order Form for return authorization, or use the online form.

SECUROS Surgical Instrument Care

Clean, rinse and sterilize every new instrument before its first use. Immediately after use, rinse and manually clean instruments using SECUROS Manual & Ultrasonic Instrument Cleaner (#003425). Whenever possible, use distilled water to prevent biological materials from drying on the surface.

Manual Cleaning

- Always use Manual & Ultrasonic Instrument Cleaner. This solution has a neutral pH to prevent staining on instruments.
- Use distilled water for final rinsing.

Lubrication

- Lubricate all instruments with a box lock.
- Spray lubricant onto clean surgical instruments.
- Wipe excess lube from surfaces.

Ultrasonic Cleaning

- Clean instruments in the open position.
- Avoid overloading the chamber and piling instruments on top of one another.

Sterilizing

- Ensure that instruments have been properly cleaned before sterilization.
- Lubricate moving parts of each instrument with Instrument Spray Lubricant.
- Autoclave instruments in the open position.

Inspection

- Visually inspect all surfaces of the instruments for stains, cracks, or chips.
- Test scissors using a latex scissor test material for proper cutting action.
- Needle holders and hemostats should engage properly and meet correctly at the tips.

Storage

- Store instruments in a climate-controlled area.
- Do not store instruments near chemicals that may emit a vapor.
- Ensure that all instruments are completely dry before storing them.

Lubricants



MWI#	SECUROS#	PRODUCT	UNIT
030294	003418	Instrument Spray Lubricant	8 oz.
034255	003423	Instrument Lubricant Milk	1 Gallon

Stain Removers



MWI#	SECUROS#	PRODUCT	UNIT
003419	003419	Instrument Stain Removing Powder	8 oz.

**Cleaner samples are available.
Please call a sales representative for information.**

Cleaners



MWI#	SECUROS#	PRODUCT	UNIT	FORM
033415	003420	Enzymatic Foam Instrument Cleaner	32 oz.	Liquid
033416	003421	Multi-Enzyme Cleaner Packets	32 1/2 oz. Packets	Liquid
055000	003424	Multi-Enzyme Cleaner	1 Gallon	Liquid
043933	003422	Instrument Cleaner and Lubricant	1 Gallon	Liquid
030293	003417	Manual and Ultrasonic Cleaner	8 oz.	Liquid
035674	003425	Manual and Ultrasonic Cleaner	1 Gallon	Liquid
035410	003975	Manual and Ultrasonic Cleaner	3.5 lbs.	Powder
035675	003426	Autoclave Foam Cleaner <i>*Hazmat - must ship UPS Ground Only</i>	22 oz.	Liquid

SURGICAL INSTRUMENTS

Scalpel Handles & Blades

Scalpel Handles 323

Sterile Surgical Blades 324



Scalpel Handles



Microsurgical (Beaver®)



No. 3



No. 3 Graduated



No. 3 Long



No. 4



No. 4 Long



No. 7

MWI#	SECUROS#	PRODUCT
031033	001310	Microsurgical (Beaver®) Blade Handle 4" Length
048033	840005	Microsurgical (Beaver®) Blade Handle 5" Length
042167	830026	Scalpel Handle No. 3
039125	816600	Scalpel Handle No. 3 Graduated
049162	840000	Scalpel Handle No. 3 Long
039508	840001	Scalpel Handle No. 4
049163	840002	Scalpel Handle No. 4 Long
045243	840003	Scalpel Handle No. 7

Stainless Steel Sterile Surgical Blades



MWI#	SECUROS#	PRODUCT
033870	003299	Sterile Scalpel Blade No. 10 100/Box
033872	003301	Sterile Scalpel Blade No. 11 100/Box
033873	003302	Sterile Scalpel Blade No. 12 100/Box
033871	003303	Sterile Scalpel Blade No. 15 100/Box
033874	003304	Sterile Scalpel Blade No. 20 100/Box

Stainless Steel Sterile Surgical Blades

	MWI#	SECUROS#	PRODUCT
	033875	003305	Sterile Scalpel Blade No. 21 100/Box
	033876	003307	Sterile Scalpel Blade No. 22 100/Box
	■ 276420	840730	Sterile Scalpel Blade Beaver® Style 61 12/Box
	■ 276421	840731	Sterile Scalpel Blade Beaver® Style 62 12/Box
	031036	001311	Sterile Scalpel Blade Beaver® Style 64 12/Box
	045394	840732	Sterile Scalpel Blade Beaver® Style 67 12/Box
	031138	001312	Sterile Scalpel Blade Beaver® Style 67MIS 12/Box

SURGICAL INSTRUMENTS

Scissors

Overview.....	327	Iris.....	337
Operating.....	328	Tenotomy.....	337
Mayo Dissecting.....	330	Strabismus.....	338
Metzenbaum.....	332	Martin Cartilage.....	338
Potts-Smith.....	333	Vannas.....	338
Bandage.....	334	Tungsten-Carbide Edge.....	339
Utility.....	335	SuperCut.....	339
Wire Cutting.....	335		
Stitch.....	336		



Scissors

Standard Model Scissors

SECUROS Surgical's Standard Model scissors are hand-crafted in Germany using the finest quality German steel. SECUROS' Standard Model scissors are sharpened using the latest manufacturing techniques, have a rich satin finish, and provide unsurpassed value and quality. SECUROS' Standard Model scissors are backed by the best warranty in the industry, which includes FREE sharpening throughout the life of the scissor.

Tungsten Carbide-Gold Handled Scissors

SECUROS Surgical's Tungsten Carbide Scissors are hand-crafted in Germany using the finest quality German steel. SECUROS' Tungsten Carbide Scissors are identified with gold rings and have welded Tungsten Carbide inserts within the blades. The Tungsten Carbide inserts provide an ultimate hardness and provide improved sharpness over standard model scissors. SECUROS' Tungsten Carbide Scissors are sharpened using the latest manufacturing techniques, have a rich satin finish and provide unsurpassed quality. SECUROS' Tungsten Carbide Scissors are backed by the best warranty in the industry, which includes FREE sharpening throughout the life of the scissor.

SuperCut-Black Handled Scissors

SECUROS Surgical's SuperCut Scissors are hand-crafted in Germany using the finest quality German steel. SECUROS' SuperCut Scissors are identified by a shiny, mirror finish and black chromed handles. SECUROS Surgical's SuperCut Scissors are the sharpest scissors offered, as they have one razor sharp blade and a second serrated blade that provides for traction when cutting. SECUROS' SuperCut Scissors are backed by the best warranty in the industry, which includes FREE sharpening throughout the life of the scissor.



Scissors: Operating



Straight Blunt-Blunt (TC)



Straight Blunt-Blunt



Straight Sharp-Blunt (TC)



Straight Sharp-Blunt



Straight Sharp-Sharp (TC)



Straight Sharp-Sharp

MWI#	SECUROS#	PRODUCT	FEATURE	SIZE
048656	800340	Operating Scissors	Straight Blunt-Blunt	4.5" (11.5cm)
048467	840617	Operating Scissors	Curved Blunt-Blunt	4.5" (11.5cm)
048657	800550	Operating Scissors	Straight Sharp-Blunt	4.5" (11.5cm)
048468	840618	Operating Scissors	Straight Sharp-Sharp	4.5" (11.5cm)
045217	800870	Operating Scissors	Curved Sharp-Sharp	4.5" (11.5cm)
048469	840619	Operating Scissors	Curved Sharp-Blunt	4.5" (11.5cm)
045039	840620	Operating Scissors	Straight Sharp-Blunt	5" (12.7cm)
046192	840621	Operating Scissors	Straight Sharp-Sharp	5" (12.7cm)
046193	840622	Operating Scissors	Straight Blunt-Blunt	5" (12.7cm)
048470	840623	Operating Scissors	Straight Blunt-Blunt	5.5" (14cm)
042166	830025	Opearting Scissors	Straight Sharp-Blunt	5.5" (14cm)

Scissors: Operating



Curved Blunt-Blunt



Curved Sharp-Blunt



Curved Sharp-Sharp

MWI#	SECUROS#	PRODUCT	FEATURE	SIZE
033402	800810	Operating Scissors	Straight Sharp-Sharp	5.5" (14cm)
048471	840624	Operating Scissors	Curved Blunt-Blunt	5.5" (14cm)
048472	840625	Operating Scissors	Curved Sharp-Blunt	5.5" (14cm)
049164	840006	Operating Scissors	Curved Sharp-Sharp	5.5" (14cm)
048473	840626	Operating Scissors	Straight Blunt-Blunt	6.5" (16.5cm)
045361	840627	Operating Scissors	Straight Sharp-Blunt	6.5" (16.5cm)
048474	840628	Operating Scissors	Straight Sharp-Sharp	6.5" (16.5cm)
048476	840629	Operating Scissors	Curved Blunt-Blunt	6.5" (16.5cm)
048477	840630	Operating Scissors	Curved Sharp-Blunt	6.5" (16.5cm)
049165	840007	Operating Scissors	Curved Sharp-Sharp	6.5" (16.5cm)

Scissors: Mayo Dissecting



5.5" Straight (TC)



5.5" Straight



5.5" Curved (TC)



5.5" Curved



6.75" Straight (TC)



6.75" Straight



6.75" Straight (SuperCut)

Scissors: Mayo Dissecting



6.75" Curved (TC)



6.75" Curved (SuperCut)



6.75" Curved



9" Straight



9" curved

MWI#	SECUROS#	PRODUCT	FEATURE	SIZE
033441	801190	Mayo Dissecting Scissors	Straight	5.5" (14cm)
039501	801260	Mayo Dissecting Scissors	Curved	5.5" (14cm)
033439	801210	Mayo Dissecting Scissors	Straight	6.75" (17.1cm)
039502	801280	Mayo Dissecting Scissors	Curved	6.75" (17.1cm)
049029	801240	Mayo Dissecting Scissors	Straight	9" (22.9cm)
049036	801310	Mayo Dissecting Scissors	Curved	9" (22.9cm)

Scissors: Metzenbaum



Lahey: Straight (TC)



Lahey: Straight



Lahey: Curved (TC)



Lahey: Curved

MWI#	SECUROS#	PRODUCT	FEATURE	SIZE
049071	840631	Metzenbaum Scissors (Lahey) Pedifine	Straight	4.5" (11.5cm)
047522	840632	Metzenbaum Scissors (Lahey) Pedifine	Curved	4.5" (11.5cm)
056000	802381	Metzenbaum Scissors (Lahey)	Straight	5.75" (14.6cm)
039015	802382	Metzenbaum Scissors (Lahey)	Curved	5.75" (14.6cm)

Scissors: Metzenbaum



Nelson: Straight

Nelson: Straight (TC)



Nelson: Curved

Nelson: Curved (TC)

MWI#	SECUROS#	PRODUCT	FEATURE	SIZE
045395	840734	Metzenbaum Scissors (Nelson)	Straight	7" (17.8cm)
033388	802230	Metzenbaum Scissors (Nelson)	Curved	7" (17.8cm)
049573	840634	Metzenbaum Scissors (Nelson)	Straight	8" (20.3cm)
048574	840635	Metzenbaum Scissors (Nelson)	Curved	8" (20.3cm)
048575	840636	Metzenbaum Scissors (Nelson)	Straight	9" (22.9cm)
048478	840637	Metzenbaum Scissors (Nelson)	Curved	9" (22.9cm)
048577	840638	Metzenbaum Scissors (Nelson)	Straight	10" (25.4cm)
045040	840639	Metzenbaum Scissors (Nelson)	Curved	10" (25.4cm)
048479	840640	Metzenbaum Scissors (Nelson)	Straight	11" (27.9cm)
048580	840641	Metzenbaum Scissors (Nelson)	Curved	11" (27.9cm)

Scissors: Potts-Smith



MWI#	SECUROS#	PRODUCT	FEATURE	SIZE
■ 370530	003049	Potts-Smith Scissors	25 Degree	7.5" (19.1cm)
■ 370531	003050	Potts-Smith Scissors	40 Degree	7.5" (19.1cm)
■ 370532	003051	Potts-Smith Scissors	60 Degree	7.5" (19.1cm)

■ special order item

Scissors: Bandage

Lister



Hi-Level



Knowles: Angled



Feline



Knowles: Straight



MWI#	SECUROS#	PRODUCT	FEATURE	SIZE
033396	802930	Lister Bandage Scissors		3.5" (8.9cm)
045485	840642	Lister Bandage Scissors		4.5" (11.5cm)
035920	840643	Lister Bandage Scissors		5.5" (14cm)
045362	840644	Lister Bandage Scissors		7.25" (18.4cm)
045399	803010	Lister Bandage Scissors		8" (20.3cm)
042147	840614	Hi-Level Bandage Scissors	Serrated	5.5" (14cm)
033393	814420	Knowles Bandage Scissors	Straight	5.5" (14cm)
039509	840008	Knowles Bandage Scissors	Angled	5.5" (14cm)
049169	840020	Feline Bandage Scissors		7" (17.8cm)

Scissors: Utility



Economy Utility 5.5"



Economy Utility 7.5"

MWI#	SECUROS#	PRODUCT	FEATURE	SIZE
039510	840009	Economy Utility Scissors	Serrated	5.5" (14cm)
033383	803100	Economy Utility Scissors	Serrated	7.5" (19.1cm)

Scissors: Wire Cutting



Roger Wire Cutting: Angular



Wire Cutting: Straight

MWI#	SECUROS#	PRODUCT	FEATURE	SIZE
056004	814380	Roger Wire Cutting Scissors	Serrated Angular	4.75" (12.1cm)
045245	840011	Wire Cutting Scissors	Straight	4.25" (10.8cm)

Scissors: Stitch



Spencer: Delicate



Spencer



Littauer



Northbent: Delicate, Curved Sideways



Northbent: Curved Sideways

MWI#	SECUROS#	PRODUCT	FEATURE	SIZE
033404	816450	Spencer Stitch Scissors	Delicate	3.5" (8.9cm)
033403	816470	Spencer Stitch Scissors		4.75" (12.1cm)
039507	816320	Littauer Stitch Scissors		5.5" (14cm)
047037	840013	Northbent Stitch Scissors	Delicate Curved Sideways	3.5" (8.9cm)
049166	840014	Northbent Stitch Scissors	Curved Sideways	4.75" (12.1cm)

Scissors: Iris



Tungsten Carbide



Iris Straight



Iris Curved

SuperCut

MWI#	SECUROS#	PRODUCT	FEATURE	SIZE
045067	801810	Iris Scissors	Straight	3.5" (8.9cm)
049167	840015	Iris Scissors	Curved	3.5" (8.9cm)
039503	801710	Iris Scissors	Straight	4.5" (11.5cm)
044049	801720	Iris Scissors	Curved	4.5" (11.5cm)

Scissors: Tenotomy

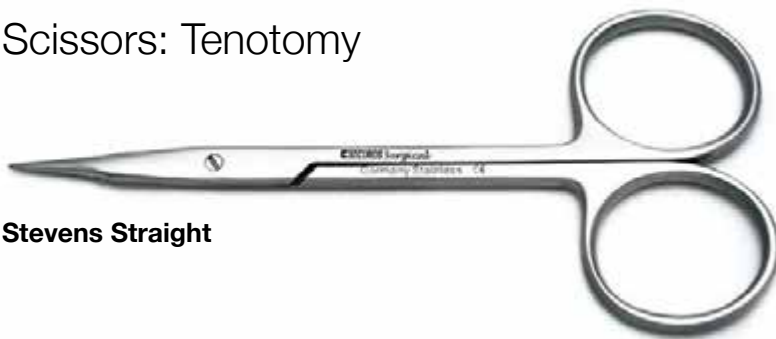

Stevens Straight



Stevens Curved

MWI#	SECUROS#	PRODUCT	FEATURE	SIZE
056005	802790	Stevens Tenotomy Scissors	Straight	4.25" (10.8cm)
045071	840016	Stevens Tenotomy Scissors	Curved	4.25" (10.8cm)

Scissors: Strabismus



Straight



Curved



MWI#	SECUROS#	PRODUCT	FEATURE	SIZE
044981	840017	Strabismus Scissors	Straight	4.5" (11.5cm)
049168	840018	Strabismus Scissors	Curved	4.5" (11.5cm)

Scissors: Martin Cartilage



Scissors



MWI#	SECUROS#	PRODUCT	FEATURE	SIZE
049216	840383	Martin Cartilage Scissors	Serrated Blades, Curved	7.75" (19.7cm)

Scissors: Vannas



MWI#	SECUROS#	PRODUCT	FEATURE	SIZE
045247	840019	Vannas Scissors	Angled on Flat	3" (7.6cm)



Scissors: Tungsten-Carbide Edge

MWI#	SECUROS#	PRODUCT	FEATURE	SIZE
048658	840645	Iris Scissors	Straight Carbide Edge	4.5" (11.5cm)
048480	840646	Iris Scissors	Curved Carbide Edge	4.5" (11.5cm)
045248	840021	Roger Wire Cutting Scissors	Serrated Angular Carbide Edge	4.75" (12.1cm)
045486	840647	Metzenbaum Scissors (Lahey)	Straight Delicate Carbide Edge	5.5" (14cm)
048481	840648	Metzenbaum Scissors (Lahey)	Straight Standard Carbide Edge	5.5" (14cm)
049170	840022	Metzenbaum Scissors (Lahey)	Straight Sharp-Sharp Carbide Edge	5.5" (14cm)
045487	840649	Metzenbaum Scissors (Lahey)	Curved Delicate Carbide Edge	5.5" (14cm)
033409	802380	Metzenbaum Scissors (Lahey)	Curved Standard Carbide Edge	5.5" (14cm)
049171	840023	Metzenbaum Scissors (Lahey)	Curved Sharp-Sharp Carbide Edge	5.5" (14cm)
048659	840687	Metzenbaum Scissors (Nelson)	Straight Standard Carbide Edge	7" (17.8cm)
048606	840657	Metzenbaum Scissors (Nelson)	Straight Delicate Carbide Edge	7" (17.8cm)
056001	830022	Metzenbaum Scissors (Nelson)	Curved Standard Carbide Edge	7" (17.8cm)
045393	840703	Metzenbaum Scissors (Nelson)	Curved Delicate Carbide Edge	7" (17.8cm)
048600	840650	Metzenbaum Scissors (Nelson)	Straight Standard Carbide Edge	9" (22.9cm)
048601	840651	Metzenbaum Scissors (Nelson)	Curved Standard Carbide Edge	9" (22.9cm)
048602	840652	Metzenbaum Scissors (Nelson)	Straight Delicate Carbide Edge	9" (22.9cm)
048603	840653	Metzenbaum Scissors (Nelson)	Curved Delicate Carbide Edge	9" (22.9cm)
045488	840654	Operating Scissors	Straight Sharp-Blunt Carbide Edge	5.5" (14cm)
048604	840655	Operating Scissors	Straight Sharp-Sharp Carbide Edge	5.5" (14cm)
048605	840656	Operating Scissors	Straight Blunt-Blunt Carbide Edge	5.5" (14cm)
055063	801340	Mayo Dissecting Scissors	Straight Carbide Edge	5.5" (14cm)
045240	801360	Mayo Dissecting Scissors	Curved Carbide Edge	5.5" (14cm)
044979	830024	Mayo Dissecting Scissors	Straight Carbide Edge	6.75" (17.1cm)
044970	801370	Mayo Dissecting Scissors	Curved Carbide Edge	6.75" (17.1cm)



Scissors: SuperCut

MWI#	SECUROS#	PRODUCT	FEATURE	SIZE
049172	840027	SuperCut Baby Metzenbaum Scissors	Straight	4.5" (11.5cm)
049173	840028	SuperCut Baby Metzenbaum Scissors	Curved	4.5" (11.5cm)
039511	840025	SuperCut Metzenbaum Scissors	Straight	5.5" (14cm)
045246	840026	SuperCut Metzenbaum Scissors	Curved	5.5" (14cm)
045244	840024	SuperCut Metzenbaum Scissors	Straight	7" (17.8cm)
045070	830023	SuperCut Metzenbaum Scissors	Curved	7" (17.8cm)
045249	840029	SuperCut Mayo Dissecting Scissors	Straight	6.75" (17.1cm)
045251	840030	SuperCut Mayo Dissecting Scissors	Curved	6.75" (17.1cm)
049175	840032	SuperCut Iris Scissors	Straight	4.5" (11.5cm)
049174	840031	SuperCut Iris Scissors	Curved	4.5" (11.5cm)

SURGICAL INSTRUMENTS

Forceps

Adson	341	Jeweler's Tweezers	345
Thumb	343	Beasley Babcock.....	345
Russian.....	344	Potts-Smith.....	346
DeBakey Tissue.....	344	Bonney	347
Carmalt	344	Ferris Smith.....	347
Plain.....	345		



Forceps: Adson Tissue



1x2 Teeth Standard



1x2 Teeth Delicate



2x3 Teeth Delicate



1x2 Teeth Delicate with Suture Platform



Cross Serrated Atraumatic Carbide Grip



1x2 with Carbide Suture Platform



MWI#	SECUROS#	PRODUCT	FEATURE	SIZE
033401	804910	Adson Tissue Forceps	1x2 Teeth Standard	4.75" (12.1cm)
049176	840035	Adson Tissue Forceps	1x2 Teeth Delicate	4.75" (12.1cm)
049188	840036	Adson Tissue Forceps	2x3 Teeth Delicate	4.75" (12.1cm)
044982	840037	Adson Tissue Forceps	1x2 Teeth Delicate with Suture Platform	4.75" (12.1cm)
049189	840038	Adson Tissue Forcep	Cross Serrated Atraumatic Carbide Grip	4.75" (12.1cm)
049190	840039	Adson Tissue Forcep	1x2 with Carbide Suture Platform	4.75" (12.1cm)

Forceps: Adson-Brown



7x7 Teeth, Side Grasp



9x9 Teeth, Side Grasp



MWI#	SECUROS#	PRODUCT	FEATURE	SIZE
033384	804930	Adson-Brown Forcep	7x7 Teeth, Side Grasp	4.75" (12.1cm)
039512	840033	Adson-Brown Forcep	9x9 Teeth, Side Grasp	4.75" (12.1cm)

Forceps: Adson Dressing



Standard



Delicate



MWI#	SECUROS#	PRODUCT	FEATURE	SIZE
033400	804850	Adson Dressing Forceps	Standard, Serrated Jaws	4.75" (12.1cm)
039513	840034	Adson Dressing Forceps	Delicate, Serrated Jaws	4.75" (12.1cm)

Forceps: Thumb Dressing



Serrated Jaws

MWI#	SECUROS#	PRODUCT	FEATURE	SIZE
049191	840040	Thumb Dressing Forceps	Serrated Handle, Serrated Jaws	4.5" (11.5cm)
045253	840041	Thumb Dressing Forceps	Serrated Handle, Serrated Jaws	5" (12.7cm)
039514	840042	Thumb Dressing Forceps	Serrated Handle, Serrated Jaws	5.5" (14cm)
049192	840043	Thumb Dressing Forceps	Serrated Handle, Serrated Jaws	6" (15.2cm)
049193	840044	Thumb Dressing Forceps	Serrated Handle, Serrated Jaws	8" (20.3cm)
049194	840045	Thumb Dressing Forceps	Serrated Handle, Serrated Jaws	10" (25.4cm)
049195	840046	Thumb Dressing Forceps	Serrated Handle, Serrated Jaws	12" (30.5cm)

Forceps: Thumb Tissue



1x2 Teeth



2x3 Teeth

MWI#	SECUROS#	PRODUCT	FEATURE	SIZE
044983	840047	Thumb Tissue Forceps	1x2 Teeth	4.5" (11.5cm)
045300	840048	Thumb Tissue Forceps	1x2 Teeth	5" (12.7cm)
039515	840049	Thumb Tissue Forceps	1x2 Teeth	5.5" (14cm)
049196	840050	Thumb Tissue Forceps	1x2 Teeth	6" (15.2cm)
046483	840051	Thumb Tissue Forceps	1x2 Teeth	8" (20.3cm)
049197	840052	Thumb Tissue Forceps	1x2 Teeth	10" (25.4cm)
049198	840053	Thumb Tissue Forceps	1x2 Teeth	12" (30.5cm)
039516	840054	Thumb Tissue Forceps	2x3 Teeth	5" (12.7cm)
049199	840055	Thumb Tissue Forceps	2x3 Teeth	5.5" (14cm)
049200	840056	Thumb Tissue Forceps	2x3 Teeth	6" (15.2cm)
045301	840057	Thumb Tissue Forceps	2x3 Teeth	8" (20.3cm)
049201	840058	Thumb Tissue Forceps	3x4 Teeth	5" (12.7cm)
049202	840059	Thumb Tissue Forceps	3x4 Teeth	5.5" (14cm)
049203	840060	Thumb Tissue Forceps	3x4 Teeth	6" (15.2cm)

Forceps: Russian



MWI#	SECUROS#	PRODUCT	SIZE
049204	840061	Russian Forcep	6" (15.2cm)
049205	840062	Russian Forcep	8" (20.3cm)
049000	840063	Russian Forcep	10" (25.4cm)

Forceps: DeBakey Tissue



MWI#	SECUROS#	PRODUCT	SIZE
042169	840064	DeBakey Tissue Forceps	1.5mm 6.25" (15.8cm)
045072	840065	DeBakey Tissue Forceps	2.0mm 6.25" (15.8cm)
049001	840066	DeBakey Tissue Forceps	3.5mm 6.25" (15.8cm)
049002	840067	DeBakey Tissue Forceps	1.5mm 7.75" (19.7cm)
044984	840068	DeBakey Tissue Forceps	2.0mm 7.75" (19.7cm)
049003	840069	DeBakey Tissue Forceps	3.5mm 7.75" (19.7cm)
055051	840070	DeBakey Tissue Forceps	2.0mm 9.5" (24.1cm)
049005	840071	DeBakey Tissue Forceps	3.5mm 9.5" (24.1cm)

Forceps: Carmalt (Splinter)



STRAIGHT

MWI#	SECUROS#	PRODUCT	FEATURE	SIZE
049006	840072	Carmalt (Splinter) Forceps	Straight	4.75" (12.1cm)
055066	840073	Carmalt (Splinter) Forceps	Curved	4.75" (12.1cm)

Forceps: Plain (Splinter)



MWI#	SECUROS#	PRODUCT	SIZE
049008	840075	Plain (Splinter) Forcep	3.5" (8.9cm)
049007	840074	Plain (Splinter) Forcep	4.5" (11.5cm)

Forceps: Jeweler's Tweezers



MWI#	SECUROS#	PRODUCT	FEATURE	SIZE
049009	840076	Jeweler's Tweezers	#5 Superfine Point	4.5" (11.5cm)

Forceps: Beasley Babcock Tissue



MWI#	SECUROS#	PRODUCT	FEATURE	SIZE
044985	840077	Beasley Babcock Tissue Forceps	Cross Points	4.75" (12.1cm)

Forceps: Potts-Smith Dressing

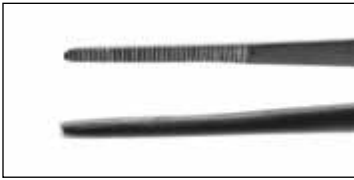

MWI#	SECUROS#	PRODUCT	FEATURE	SIZE
049010	840078	Potts-Smith Dressing Forceps	Serrated Jaw	6" (15.2cm)
049011	840079	Potts-Smith Dressing Forceps	Serrated Jaw	7" (17.8cm)
049012	840080	Potts-Smith Dressing Forceps	Serrated Jaw	8.25" (20.9cm)
049013	840081	Potts-Smith Dressing Forceps	Serrated Jaw	9.5" (24.1cm)

Forceps: Potts-Smith Tissue



MWI#	SECUROS#	PRODUCT	FEATURE	SIZE
049014	840082	Potts-Smith Tissue Forceps	1x2 Teeth	6" (15.2cm)
049015	840083	Potts-Smith Tissue Forceps	1x2 Teeth	7" (17.8cm)
049016	840084	Potts-Smith Tissue Forceps	1x2 Teeth	8.25" (20.9cm)
049017	840085	Potts-Smith Tissue Forceps	1x2 Teeth	9.5" (24.1cm)

Forceps: Bonney Tissue



MWI#	SECUROS#	PRODUCT	FEATURE	SIZE
045250	840086	Bonney Tissue Forceps	1x2 Teeth	7" (17.8cm)
049018	840087	Bonney Tissue Forceps	2x3 Teeth	7" (17.8cm)

Forceps: Ferris Smith Tissue



MWI#	SECUROS#	PRODUCT	FEATURE	SIZE
049019	840088	Ferris Smith Tissue Forceps	2x3 Teeth	6.75" (17.1cm)

SURGICAL INSTRUMENTS

Hemostats

Hartmann Mosquito.....	349	Gemini-Mixer	355
Halsted Mosquito	349	Adson	356
Micro Mosquito.....	350	Ferguson Angiotribe	356
Kelly.....	350	Meeker Kantrowitz.....	356
Kelly-Rankin.....	351	Lahey Vulsellum	357
Crile.....	351	Foerster Sponge.....	357
Crile-Rankin	352	Allis	358
Rochester-Pean.....	352	Babcock	359
Rochester-Ochsner	353	Intestinal Forceps.....	359
Rochester Carmalt.....	354		



Hemostats: Hartmann Mosquito



Straight



Curved



Straight 1 X 2 Teeth



Curved 1 X 2 Teeth

MWI#	SECUROS#	PRODUCT	FEATURE	SIZE
033440	816200	Hartmann-Mosquito Forceps	Straight Standard Pattern	3.5" (8.9cm)
033398	816440	Hartmann-Mosquito Forceps	Curved Standard Pattern	3.5" (8.9cm)
048660	840863	Hartmann-Mosquito Forceps	Straight 1x2	3.5" (8.9cm)
048661	840864	Hartmann-Mosquito Forceps	Curved 1x2	3.5" (8.9cm)

Hemostats: Halsted Mosquito



Straight



Curved



Straight 1x2 teeth



Curved 1x2 teeth



MWI#	SECUROS#	PRODUCT	FEATURE	SIZE
033387	805530	Halsted Mosquito Forceps	Straight	5" (12.7cm)
033382	805570	Halsted Mosquito Forceps	Curved	5" (12.7cm)
040399	840658	Halsted Mosquito Forceps	Straight 1x2 Teeth	5" (12.7cm)
040400	840659	Halsted Mosquito Forceps	Curved 1x2 Teeth	5" (12.7cm)

Hemostats: Micro Mosquito

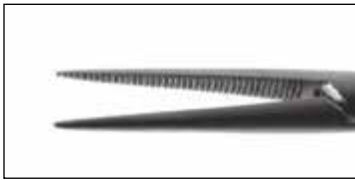

Straight



Curved



MWI#	SECUROS#	PRODUCT	FEATURE	SIZE
055067	840089	Micro Mosquito Forceps	Straight Very Delicate Pattern	4.75" (12.1cm)
044066	840090	Micro Mosquito Forceps	Curved Very Delicate Pattern	4.75" (12.1cm)

Hemostats: Kelly



Straight



Curved



MWI#	SECUROS#	PRODUCT	FEATURE	SIZE
033397	805760	Kelly Forceps	Straight	5.5" (14cm)
033391	805780	Kelly Forceps	Curved	5.5" (14cm)

Hemostats: Kelly-Rankin

**Straight****Curved**

MWI#	SECUROS#	PRODUCT	FEATURE	SIZE
045489	840660	Kelly-Rankin Forceps	Straight	6.25" (15.8cm)
045363	840661	Kelly-Rankin Forceps	Curved	6.25" (15.8cm)

Hemostats: Crile

**Straight****Curved**

MWI#	SECUROS#	PRODUCT	FEATURE	SIZE
045510	805840	Crile Forceps	Straight	5.5" (14cm)
033438	805860	Crile Forceps	Curved	5.5" (14cm)

Hemostats: Crile-Rankin



Straight



Curved



MWI#	SECUROS#	PRODUCT	FEATURE	SIZE
045302	840091	Crile-Rankin Forceps	Straight	6.25" (15.8cm)
045500	840662	Crile-Rankin Forceps	Curved	6.25" (15.8cm)

Hemostats: Rochester-Pean



Straight



Curved



MWI#	SECUROS#	PRODUCT	FEATURE	SIZE
039525	840663	Rochester-Pean Forceps	Straight	6.25" (15.8cm)
045242	806040	Rochester-Pean Forceps	Curved	6.25" (15.8cm)
048607	840664	Rochester-Pean Forceps	Straight	7.25" (18.4cm)
048662	840665	Rochester-Pean Forceps	Curved	7.25" (18.4cm)
048663	805970	Rochester-Pean Forceps	Straight	8" (20.3cm)
048608	840666	Rochester-Pean Forceps	Curved	8" (20.3cm)
048609	840667	Rochester-Pean Forceps	Straight	9" (22.9cm)
048610	840668	Rochester-Pean Forceps	Curved	9" (22.9cm)
048611	840669	Rochester-Pean Forceps	Straight	10" (25.4cm)
048612	840670	Rochester-Pean Forceps	Curved	10" (25.4cm)
048295	840896	Rochester-Pean Forceps	Straight	12" (30.5cm)
048296	840897	Rochester-Pean Forceps	Curved	12" (30.5cm)
048297	840898	Rochester-Pean Forceps	Straight	14" (35.6cm)
048298	840899	Rochester-Pean Forceps	Curved	14" (35.6cm)

Hemostats: Rochester-Ochsner (Kocher)



Straight



Curved



MWI#	SECUROS#	PRODUCT	FEATURE	SIZE
045364	840671	Rochester-Ochsner (Kocher) Forceps	Straight	5.5" (14cm)
048664	840672	Rochester-Ochsner (Kocher) Forceps	Curved	5.5" (14cm)
045502	840673	Rochester-Ochsner (Kocher) Forceps	Straight	6.25" (15.8cm)
045501	840674	Rochester-Ochsner (Kocher) Forceps	Curved	6.25" (15.8cm)
048613	840675	Rochester-Ochsner (Kocher) Forceps	Straight	7.25" (18.4cm)
048614	840676	Rochester-Ochsner (Kocher) Forceps	Curved	7.25" (18.4cm)
048615	840677	Rochester-Ochsner (Kocher) Forceps	Straight	8" (20.3cm)
045222	840678	Rochester-Ochsner (Kocher) Forceps	Curved	8" (20.3cm)
049020	840092	Rochester-Ochsner (Kocher) Forceps	Straight	9" (22.9cm)
090048	840679	Rochester-Ochsner (Kocher) Forceps	Curved	9" (22.9cm)
048826	840093	Rochester-Ochsner (Kocher) Forceps	Straight	10" (25.4cm)
048616	840680	Rochester-Ochsner (Kocher) Forceps	Curved	10" (25.4cm)
048290	840892	Rochester-Ochsner (Kocher) Forceps	Straight	12" (30.5cm)
048291	840893	Rochester-Ochsner (Kocher) Forceps	Curved	12" (30.5cm)
048293	840894	Rochester-Ochsner (Kocher) Forceps	Straight	14" (35.6cm)
048294	840895	Rochester-Ochsner (Kocher) Forceps	Curved	14" (35.6cm)

Hemostats: Rochester Carmalt



6.25" Straight



6.25" Curved

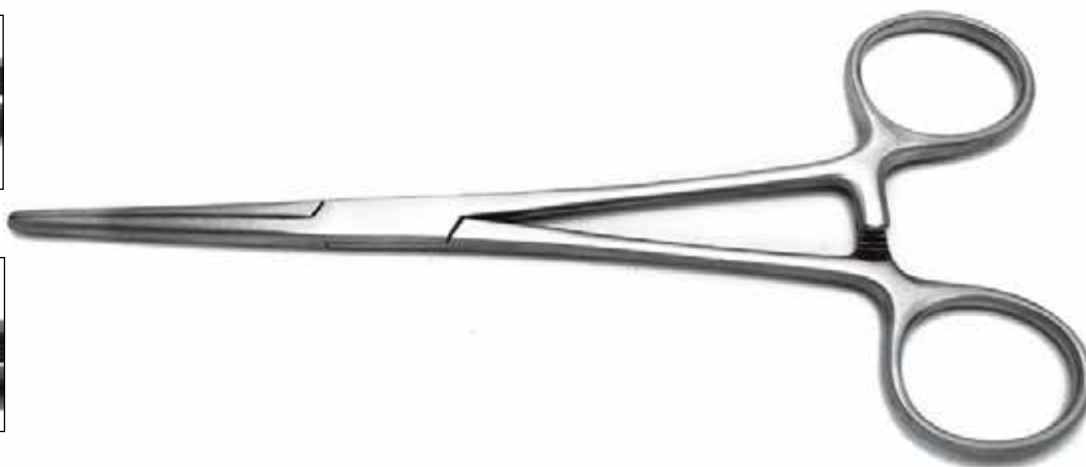

8" Straight



8" Curved



MWI#	SECUROS#	PRODUCT	FEATURE	SIZE
033399	806450	Rochester Carmalt Forceps	Straight	6.25" (15.8cm)
033389	806470	Rochester Carmalt Forceps	Curved	6.25" (15.8cm)
033442	806460	Rochester Carmalt Forceps	Straight	8" (20.3cm)
033408	816480	Rochester Carmalt Forceps	Curved	8" (20.3cm)
■	840884	Rochester Carmalt Forceps	Straight	10" (25.4cm)
■	840885	Rochester Carmalt Forceps	Curved	10" (25.4cm)
049580	840921	Rochester Carmalt Forceps	Straight	12" (30.5cm)
048644	840838	Rochester Carmalt Forceps	Curved	12" (30.5cm)
049582	840923	Rochester Carmalt Forceps	Straight	14" (35.6cm)
049581	840922	Rochester Carmalt Forceps	Curved	14" (35.6cm)

■ special order item

Hemostats: Gemini-Mixer



MWI#	SECUROS#	PRODUCT	FEATURE	SIZE
045256	840114	Gemini-Mixer Forceps	Delicate, Full Curved Jaws	5.5" (14cm)
045257	840115	Gemini-Mixer Forceps	Delicate, Full Curved Jaws	7" (17.8cm)
049026	840116	Gemini-Mixer Forceps	Delicate, Full Curved Jaws	8" (20.3cm)
049027	840117	Gemini-Mixer Forceps	Delicate, Full Curved Jaws	9" (22.9cm)
048300	840901	Gemini-Mixer Forceps	Delicate, Full Curved Jaws	11" (27.9cm)

Hemostats: Adson



MWI#	SECUROS#	PRODUCT	FEATURE	SIZE
049028	840118	Adson Forceps	Curved	7.25" (18.4cm)
048134	840119	Adson Forceps	Straight	7.25" (18.4cm)

Hemostats: Ferguson Angiotribe



Straight



Curved



MWI#	SECUROS#	PRODUCT	FEATURE	SIZE
049030	840120	Ferguson Angiotribe Forceps	Straight	6.5" (16.5cm)
045223	807460	Ferguson Angiotribe Forceps	Curved	6.5" (16.5cm)
045224	807470	Ferguson Angiotribe Forceps	Straight	7.5" (19.7cm)
049031	840123	Ferguson Angiotribe Forceps	Curved	7.5" (19.7cm)

Hemostats: Meeker Kantrowitz



MWI#	SECUROS#	PRODUCT	FEATURE	SIZE
047123	840124	Meeker Kantrowitz Forceps	Full Curved Jaws	7.75" (19.7cm)
048302	840889	Meeker Kantrowitz Forceps		12" (30.5cm)
048303	840890	Meeker Kantrowitz Forceps		14" (35.6cm)

Hemostats: Lahey Vulsellum



MWI#	SECUROS#	PRODUCT	FEATURE	SIZE
045311	840125	Lahey Vulsellum Forceps	3x3 Teeth	6.25" (15.8cm)
048304	840891	Lahey Vulsellum Forceps	3x3 Teeth	8" (20.3cm)

Forceps: Foerster Sponge

**Straight****Curved**

MWI#	SECUROS#	PRODUCT	FEATURE	SIZE
049021	840097	Foerster Sponge Forceps	Serrated Jaws Straight	7" (17.8cm)
045305	840098	Foerster Sponge Forceps	Serrated Jaws Curved	7" (17.8cm)
049022	840099	Foerster Sponge Forceps	Serrated Jaws Straight	9.5" (24.1cm)
045306	840100	Foerster Sponge Forceps	Serrated Jaws Curved	9.5" (24.1cm)

Tissue Forceps: Allis



Pedifine Allis



Thoms-Allis



Allis Adair



Allis



MWI#	SECUROS#	PRODUCT	FEATURE	SIZE
055008	840101	Pedifine Allis Forceps	4x5 Teeth	4.75" (12.1cm)
045252	840102	Pedifine Allis Forceps	4x5 Teeth	5.75" (14.6cm)
045307	840103	Allis Forceps	3x4 Teeth	6" (15.2cm)
046216	840104	Thomas-Allis Forceps	6x7 Teeth	8" (20.3cm)
046217	840105	Allis Adair Forceps	9x10 Teeth	6" (15.2cm)
039504	803380	Allis Forceps	4x5 Teeth	6" (15.2cm)
049023	840106	Allis Forceps	5x6 Teeth	6" (15.2cm)
043920	840107	Allis Forceps	5x6 Teeth	7.5" (19.1cm)
049024	840108	Allis-Willauer Forceps	5x6 Teeth	10" (25.4cm)
048299	840900	Allis Forceps	5x6 Teeth	14" (35.6cm)

Abdominal Forceps: Babcock



MWI#	SECUROS#	PRODUCT	SIZE
045254	840109	Babcock Forceps	6.25" (15.8cm)
090019	840110	Babcock Forceps	8" (20.3cm)
049025	840111	Babcock Forceps	9.5" (24.1cm)
048305	840886	Babcock Forceps	12" (30.48cm)
048306	840887	Babcock Forceps	14" (35.56cm)
048307	840888	Babcock Forceps	18" (45.72cm)

Intestinal Forceps (Atraumatic)



MWI#	SECUROS#	PRODUCT	FEATURE	SIZE
045255	840112	Doyen Forceps	Straight	9" (22.9cm)
045310	840113	Doyen Forceps	Curved	9" (22.9cm)



MWI#	SECUROS#	PRODUCT	FEATURE	SIZE
048388	840903	Mayo-Robson Forceps	Straight	9" (22.9cm)
048389	840904	Mayo-Robson Forceps	Curved	9" (22.9cm)

SURGICAL INSTRUMENTS

Towel Clamps

Backhaus.....	361
Jones.....	362
Lorna Edna.....	362
Peers	363



Towel Clamps: Backhaus



3.5"



5.25"



5.25" With Ball Stops



MWI#	SECUROS#	PRODUCT	SIZE
033392	815920	Backhaus Towel Clamp	3.5" (8.9cm)
039506	815940	Backhaus Towel Clamp	5.25" (13.3cm)
048301	840902	Backhaus Roeder Towel Clamp with Ball Stops	5.25" (13.3cm)

Towel Clamps: Jones

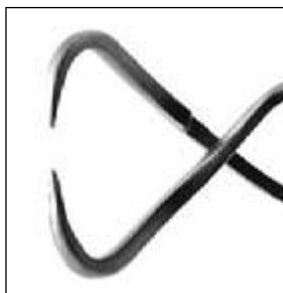

MWI#	SECUROS#	PRODUCT	SIZE
044051	840094	Jones Towel Clamp	3" (7.6cm)

Towel Clamps: Lorna Edna



4"



5.25"



MWI#	SECUROS#	PRODUCT	FEATURE	SIZE
042168	830027	Lorna Edna Towel Clamp	Non-Perforating	4" (10.2cm)
045303	840095	Lorna Edna Towel Clamp	Non-Perforating	5.25" (13.3cm)

Towel Clamps: Peers



MWI#	SECUROS#	PRODUCT	FEATURE	SIZE
045304	840096	Peers Towel Clamp	Non-Perforating	5.5" (14cm)

SURGICAL INSTRUMENTS

Needle Holders

Halsey.....	365	Ryder (French Eye)	369
Derf.....	365	Mathieu.....	369
Webster	366	Castroviejo	370
Olsen-Hegar	366	Barraquer.....	370
Mayo-Hegar.....	368	Heaney	371
Crile-Wood.....	368	Cruciate	371



Needle Holders: Halsey



Smooth Standard Jaw



Smooth TC Jaw



Standard

Tungsten Carbide

MWI#	SECUROS#	PRODUCT	FEATURE	SIZE
049032	840126	Halsey Needle Holder	Smooth Jaws	5" (12.7cm)
045312	840127	Halsey Needle Holder	Serrated Jaws	5" (12.7cm)
049033	840128	Halsey Needle Holder	Tungsten Carbide, Smooth Jaw	5" (12.7cm)
045313	840129	Halsey Needle Holder	Tungsten Carbide, Serrated Jaw	5" (12.7cm)

Needle Holders: Derf



Serrated Jaw



TC Jaw



Standard

Tungsten Carbide

MWI#	SECUROS#	PRODUCT	FEATURE	SIZE
045314	840130	Derf Needle Holder	Stainless Steel Serrated Jaws	4.75" (12.1cm)
055068	840131	Derf Needle Holder	Tungsten Carbide Jaws	4.75" (12.1cm)

Needle Holders: Webster



Smooth Jaw



MWI#	SECUROS#	PRODUCT	FEATURE	SIZE
049034	840132	Webster Needle Holder	Smooth Jaws	5" (12.7cm)

Needle Holders: Baby Olsen-Hegar



Standard



Tungsten Carbide



MWI#	SECUROS#	PRODUCT	SIZE
045315	840133	Baby Olsen-Hegar Needle Holder	4.5" (11.5cm)
045258	840136	Baby Olsen-Hegar Needle Holder Tungsten Carbide Jaws	4.5" (11.5cm)

Needle Holders: Olsen-Hegar



5.5" Olsen-Hegar



6.5" Olsen-Hegar



7.5" Olsen-Hegar



6.5" European Pattern Tungsten Carbide



5.5" Standard



5.5" Tungsten Carbide



6.5" Standard



6.5" Tungsten Carbide



7.5" Standard



7.5" Tungsten Carbide



6.5" European Pattern Tungsten Carbide

MWI#	SECUROS#	PRODUCT	FEATURE	SIZE
033394	809960	Olsen-Hegar Needle Holder	Stainless Jaws	5.5" (14cm)
033390	840134	Olsen-Hegar Needle Holder	Stainless Jaws	6.5" (16.5cm)
045120	840135	Olsen-Hegar Needle Holder	Stainless Jaws	7.5" (19.1cm)
033386	809970	Olsen-Hegar Needle Holder	Tungsten Carbide Jaws	5.5" (14cm)
033385	810010	Olsen-Hegar Needle Holder	Tungsten Carbide Jaws	6.5" (16.5cm)
033395	809990	Olsen-Hegar Needle Holder	Tungsten Carbide Jaws	7.5" (19.1cm)
045317	840137	Olsen-Hegar Needle Holder	European Pattern	6.5" (16.5cm)

Needle Holders: Mayo-Hegar



Standard



Tungsten Carbide



Standard

Tungsten Carbide

MWI#	SECUROS#	PRODUCT	FEATURE	SIZE
055069	840138	Mayo-Hegar Needle Holder	Standard	5.25" (13.3cm)
045318	840139	Mayo-Hegar Needle Holder	Standard	6" (15.2cm)
045319	840140	Mayo-Hegar Needle Holder	Standard	7" (17.8cm)
049329	840141	Mayo-Hegar Needle Holder	Standard	8" (20.3cm)
045320	840142	Mayo-Hegar Needle Holder	Tungsten Carbide Jaws	5.25" (13.3cm)
033405	809380	Mayo-Hegar Needle Holder	Tungsten Carbide Jaws	6" (15.2cm)
044063	840143	Mayo-Hegar Needle Holder	Tungsten Carbide Jaws	7" (17.8cm)
045321	840144	Mayo-Hegar Needle Holder	Tungsten Carbide Jaws	8" (20.3cm)
049035	840145	Mayo-Hegar Needle Holder	Tungsten Carbide Jaws	10.5" (26.7cm)
049037	840146	Mayo-Hegar Needle Holder	Tungsten Carbide Jaws	12" (30.5cm)

Needle Holders: Crile-Wood



Standard



Tungsten Carbide



Standard

Tungsten Carbide

MWI#	SECUROS#	PRODUCT	FEATURE	SIZE
049038	840147	Crile-Wood Needle Holder	Narrow Jaws	6" (15.2cm)
045322	840148	Crile-Wood Needle Holder	Tungsten Carbide Jaws	6" (15.2cm)
049039	840149	Crile-Wood Needle Holder	Tungsten Carbide Jaws	7" (17.8cm)
■	840150	Crile-Wood Needle Holder	Tungsten Carbide Jaws	8" (20.3cm)
049040	840151	Crile-Wood Needle Holder	Tungsten Carbide Jaws	9" (22.9cm)
■	840152	Crile-Wood Needle Holder	Tungsten Carbide Jaws	10" (25.4cm)
■	840153	Crile-Wood Needle Holder	Tungsten Carbide Jaws	12" (30.5cm)

■ special order item

Needle Holders: Ryder (French Eye)



Tungsten Carbide



MWI#	SECUROS#	PRODUCT	FEATURE	SIZE
090020	840154	Ryder (French Eye) Needle Holder	Tungsten Carbide Jaws	5" (12.7cm)
049041	840155	Ryder (French Eye) Needle Holder	Tungsten Carbide Jaws	6" (15.2cm)
049042	840156	Ryder (French Eye) Needle Holder	Tungsten Carbide Jaws	7" (17.8cm)
049043	840157	Ryder (French Eye) Needle Holder	Tungsten Carbide Jaws	8" (20.3cm)
049044	840158	Ryder (French Eye) Needle Holder	Tungsten Carbide Jaws	9" (22.9cm)

Needle Holders: Mathieu



Standard



Standard



Tungsten Carbide



Tungsten Carbide

MWI#	SECUROS#	PRODUCT	FEATURE	SIZE
045323	840159	Mathieu Needle Holder	Standard	5.5" (14cm)
045324	840160	Mathieu Needle Holder	Standard	6.5" (16.5cm)
045325	840161	Mathieu Needle Holder	Tungsten Carbide Jaws	5.5" (14cm)
045326	840162	Mathieu Needle Holder	Tungsten Carbide Jaws	6.5" (16.5cm)

Needle Holders: Castroviejo



Standard

Standard



Tungsten Carbide

Tungsten Carbide

MWI#	SECUROS#	PRODUCT	FEATURE	SIZE
055070	840163	Castroviejo Needle Holder	Straight, Smooth with Lock	5.5" (14cm)
044986	840164	Castroviejo Needle Holder	Straight, Smooth with Lock Tungsten Carbide Jaws	5.5" (14cm)

Needle Holders: Barraquer



Straight Smooth



Curved Smooth

MWI#	SECUROS#	PRODUCT	FEATURE	SIZE
048827	816420	Barraquer Needle Holder	Straight, Smooth Jaws with Lock	5.5" (14cm)
■ 276428	816400	Barraquer Needle Holder	Curved, Smooth Jaws with Lock	5.5" (14cm)

■ special order item

Needle Holders: Heaney



Tungsten Carbide



MWI#	SECUROS#	PRODUCT	FEATURE	SIZE
049045	840166	Heaney Needle Holder	Tungsten Carbide Jaws Curved	8.25" (20.9cm)
049046	840167	Heaney Needle Holder	Tungsten Carbide Jaws Curved	10" (25.4cm)

Needle Holders: Cruciate



MWI#	SECUROS#	PRODUCT	FEATURE	SIZE
043935	840168	Cruciate Needle Holder	Tungsten Carbide Jaws	7" (17.8cm)

SURGICAL INSTRUMENTS

Retractors

Senn	373	Balfour	378
Ragnell.....	373	Gossett Abdominal.....	379
Lahey.....	373	Inge.....	379
Alm	374	U.S. Army	380
Holzheimer.....	374	Hohmann.....	380
Gelpi	375	Ribbon.....	381
Weitlaner.....	376	Meyerding.....	382
Stifle.....	377		
Wallace Knee.....	378		



Retractors: Senn



Sharp

MWI#	SECUROS#	PRODUCT	FEATURE	SIZE
030961	815750	Senn Retractor	3 Prongs Sharp	6.25" (15.8cm)
056013	840169	Senn Retractor	3 Prongs Blunt	6.25" (15.8cm)

Retractors: Ragnell



MWI#	SECUROS#	PRODUCT	FEATURE	SIZE
■	840170	Ragnell Retractor	Double Ended	6" (15.2cm)

Retractors: Lahey

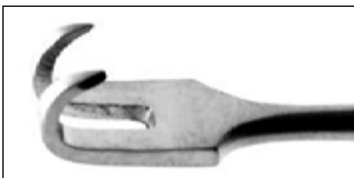

MWI#	SECUROS#	PRODUCT	FEATURE	SIZE
049047	840171	Lahey Retractor	1 Prong Sharp	4.75" (12.1cm)
■	840172	Lahey Retractor	2 Prongs Sharp	4.75" (12.1cm)
049049	840173	Lahey Retractor	3 Prongs Sharp	4.75" (12.1cm)

■ special order item

Retractors: Alm



MWI#	SECUROS#	PRODUCT	FEATURE	SIZE
■	840174	Alm Retractor	4x4 Prongs	2.75" (7cm)
049051	840175	Alm Retractor	4x4 Prongs	4" (10.2cm)

Retractors: Holzheimer

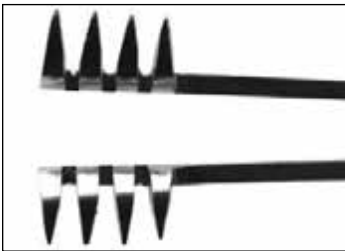

MWI#	SECUROS#	PRODUCT	FEATURE	SIZE
049052	840176	Holzheimer Retractor	Sharp 4x4 Prongs	4" (10.2cm)
049053	840177	Holzheimer Retractor	Blunt 4x4 Prongs	4" (10.2cm)

■ special order item

Retractors: Gelpi



MWI#	SECUROS#	PRODUCT	SIZE
035922	840178	Gelpi Retractor	3.5" (8.9cm)
036190	840179	Gelpi Retractor	4.5" (11.5cm)
055012	808920	Gelpi Retractor	5.5" (14cm)



MWI#	SECUROS#	PRODUCT	SIZE
039505	808940	Gelpi Retractor	7.5" (19.1cm)



MWI#	SECUROS#	PRODUCT	FEATURE	SIZE
045178	003778	Gelpi Retractor	Stop Ball Tips	7.5" (19.1cm)



MWI#	SECUROS#	PRODUCT	FEATURE	SIZE
045168	840835	Gelpi Retractor	90 Degree	7.5" (19.1cm)

Retractors: Weitlaner



Baby Weitlaner



Weitlaner

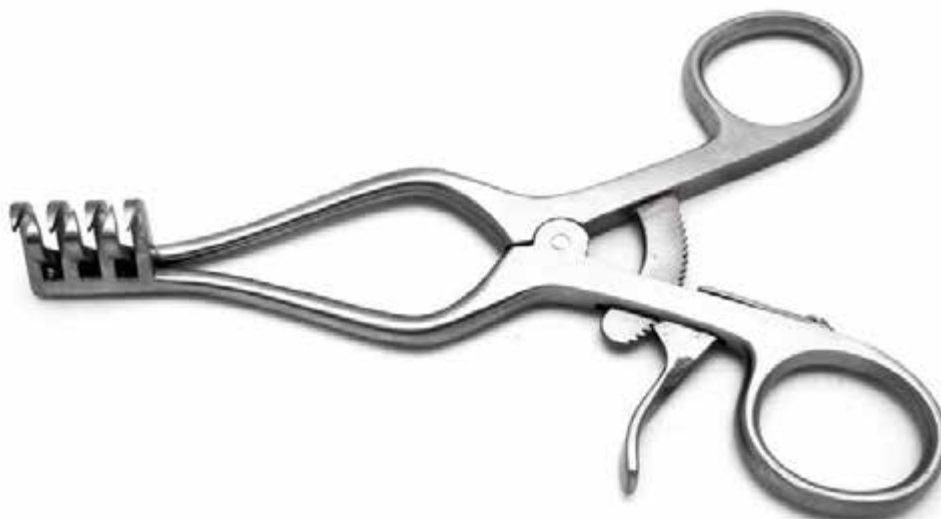

MWI#	SECUROS#	PRODUCT	FEATURE	SIZE
045327	840180	Baby Weitlaner Retractor	Sharp 2x3 Prongs	4" (10.2cm)
049054	840181	Baby Weitlaner Retractor	Blunt 2x3 Prongs	4" (10.2cm)
044987	840182	Weitlaner Retractor	Sharp 3x4 Prongs	5.5" (14cm)
045503	840681	Weitlaner Retractor	Blunt 3x4 Prongs	5.5" (14cm)
044973	808710	Weitlaner Retractor	Sharp 3x4 Prongs	6.5" (16.5cm)
045328	840183	Weitlaner Retractor	Blunt 3x4 Prongs	6.5" (16.5cm)
045329	840184	Weitlaner Retractor	Sharp 3x4 Prongs	8" (20.3cm)
049055	840185	Weitlaner Retractor	Blunt 3x4 Prongs	8" (20.3cm)
■	840186	Weitlaner Retractor	Sharp 3x4 Prongs	9.5" (24.1cm)
■	840187	Weitlaner Retractor	Blunt 3x4 Prongs	9.5" (24.1cm)

■ special order item

Retractors: Stifle



Small Stifle



With Speed Lock



MWI#	SECUROS#	PRODUCT	FEATURE	SIZE
048828	840188	Small Stifle Retractor	With Speed Lock, Cross-Action Tips	5" (12.7cm)
042170	840190	Stifle Retractor	With Speed Lock, Cross-Action Tips	7" (17.8cm)

Retractors: Wallace Knee



MWI#	SECUROS#	PRODUCT	SIZE
030964	840189	Wallace Knee Retractor	5" (12.7cm)

Retractors: Balfour

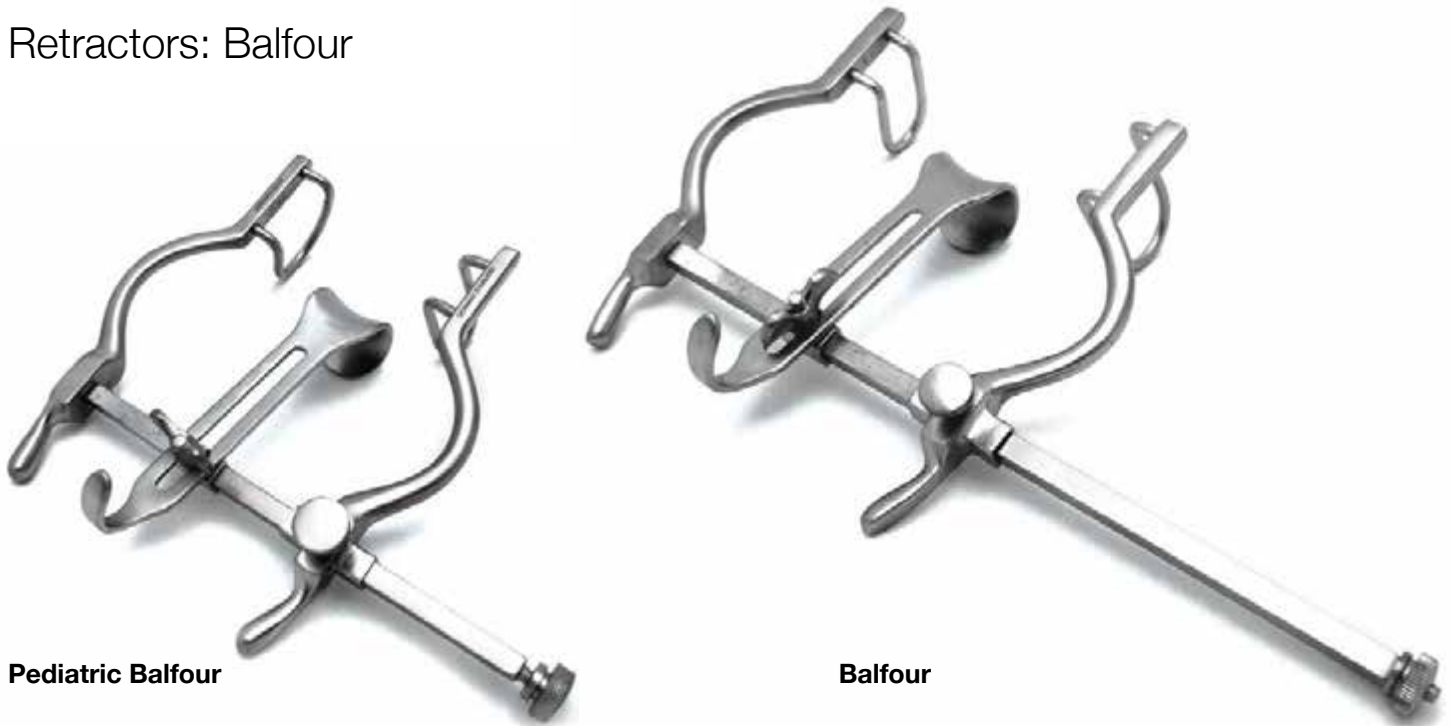

Pediatric Balfour

Balfour

MWI#	SECUROS#	PRODUCT	SIZE
045511	808900	Pediatric Balfour Retractor	3.5" (8.9cm) Spread
045365	840682	Balfour Retractor	7" (17.8cm) Spread

Retractors: Gossett Abdominal



MWI#	SECUROS#	PRODUCT	SIZE
044988	840192	Gossett Abdominal Retractor	5.5" (14cm)

Retractors: Inge



6.5" Inge



11" Inge



MWI#	SECUROS#	PRODUCT	SIZE
049056	840194	Inge Retractor	6.5" (16.5cm)
049057	840195	Inge Retractor	11" (27.9cm)

Retractors: U.S. Army



MWI#	SECUROS#	PRODUCT	FEATURE	SIZE
045262	840193	U.S. Army Retractor	0.625" Wide (1.6cm) - Set of 2	8.5" (21.6cm)

Retractors: Hohmann



Mini Hohmann 6mm Width



Mini Hohmann 8mm Width



Hohmann 12mm Width



Hohmann 18mm Width



Hohmann 10mm Width 90 Degree Angle

MWI#	SECUROS#	PRODUCT	FEATURE	SIZE
030962	840196	Mini Hohmann Retractor	6mm Width	6.5" (16.5cm)
055014	813880	Mini Hohmann Retractor	8mm Width	6.5" (16.5cm)
030963	813780	Hohmann Retractor	8mm Width	8.5" (21.6cm)
045558	840197	Hohmann Retractor	12mm Width	8" (20.3cm)
043804	840198	Hohmann Retractor	18mm Width	9" (22.9cm)
045113	001307	Hohmann Retractor	10mm Width	8" (20.3cm) 90 Degree Angle

Retractors: Ribbon

**Baby Ribbon****13" Ribbon**

MWI#	SECUROS#	PRODUCT	FEATURE	SIZE
049058	840200	Baby Ribbon Retractor	Malleable .25" (.6cm)	7" (17.8cm)
■ 370241	840201	Baby Ribbon Retractor	Malleable .5" (1.3cm)	7" (17.8cm)
049059	840202	Baby Ribbon Retractor	Malleable .75" (1.9cm)	7" (17.8cm)
048829	840199	Baby Ribbon Retractor	Malleable 1.0" (2.5cm)	7" (17.8cm)
045263	840203	Ribbon Retractor	Malleable .75" (1.9cm)	13" (33cm)
048830	840204	Ribbon Retractor	Malleable 1.0" (2.5cm)	13" (33cm)
045600	840205	Ribbon Retractor	Malleable 1.25" (3.1cm)	13" (33cm)
049060	840206	Ribbon Retractor	Malleable 1.5" (3.8cm)	13" (33cm)
■ 276572	840207	Ribbon Retractor	Malleable 2.0" (5.1cm)	13" (33cm)
■	840208	Ribbon Retractor	Malleable 2.5" (6.4cm)	13" (33cm)
049061	840209	Ribbon Retractor	Malleable 3.0" (7.6cm)	13" (33cm)
■	004131	Ribbon Retractor	Malleable 5.0" (12.7cm)	13" (33cm)

Retractors: Meyerding

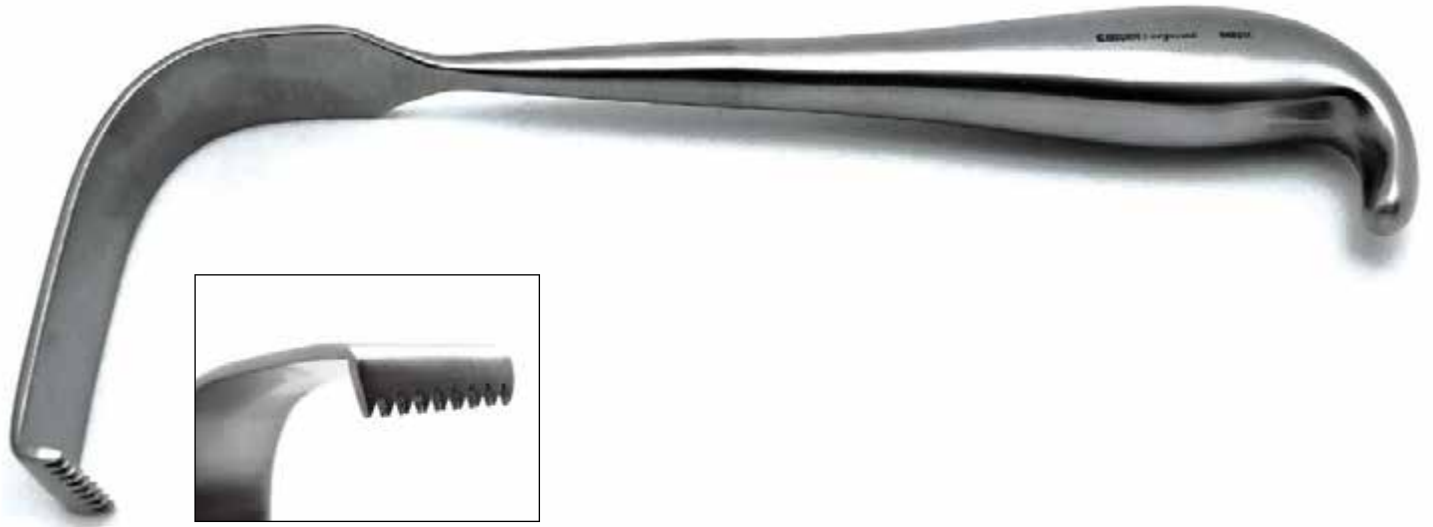

MWI#	SECUROS#	PRODUCT	FEATURE	SIZE
045266	840210	Meyerding Retractor	52mm x 16mm Blade, Small	9" (22.9cm)
044989	840211	Meyerding Retractor	75mm x 25mm Blade, Medium	9" (22.9cm)
049062	840212	Meyerding Retractor	89mm x 50mm Blade, Large	9" (22.9cm)



SURGICAL INSTRUMENTS

Miscellaneous

Suction Tubes.....	385	Finger Ring Cutters.....	390
Hooks.....	386	Cutaneous Punches.....	390
Nail Clippers.....	387	Ear Loops.....	391
Percussion Hammers.....	387	Ear Curettes.....	391
Young Tongue Forceps.....	387	Forceps.....	392
Directors.....	387	Clamps.....	393
Probes.....	388	Instrument Stringers.....	393
Scoops.....	388		
Speculums.....	389		
Mouth Gags.....	389		
Tourniquets.....	390		



Suction Tubes

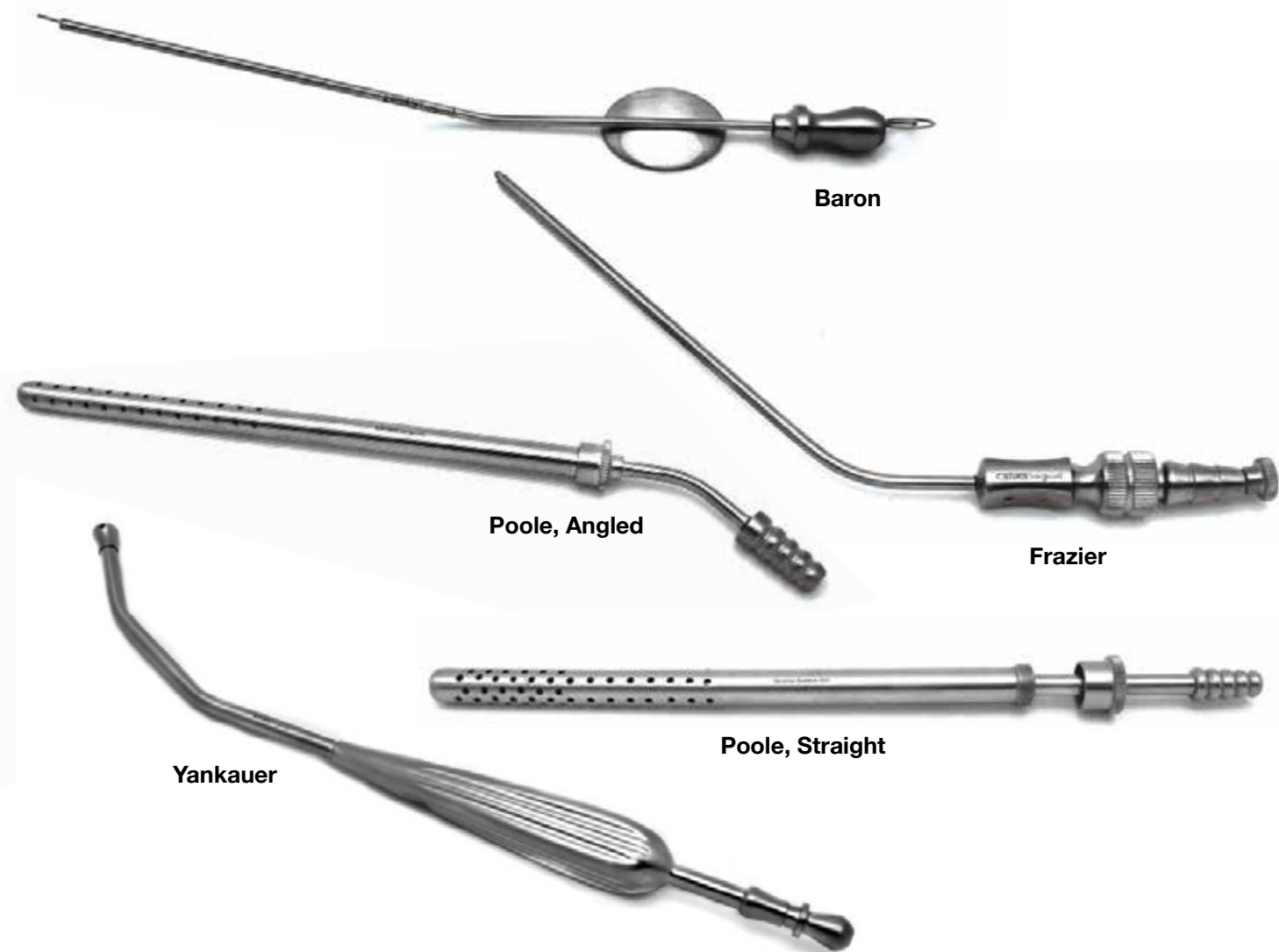

MWI#	SECUROS#	PRODUCT	FRENCH	SIZE
045029	840417	Baron Suction Tube	Size 3 French	7.5" (19.1cm)
049223	840418	Baron Suction Tube	Size 5 French	7.5" (19.1cm)
049224	840419	Baron Suction Tube	Size 7 French	7.5" (19.1cm)
045030	840420	Frazier Suction Tube	Angled Size 6 French	7.25" (18.4cm)
045294	840421	Frazier Suction Tube	Angled Size 7 French	7.25" (18.4cm)
045295	840422	Frazier Suction Tube	Angled Size 8 French	7.25" (18.4cm)
045349	840423	Frazier Suction Tube	Angled Size 9 French	7.25" (18.4cm)
045375	840424	Frazier Suction Tube	Angled Size 10 French	7.25" (18.4cm)
045385	840425	Frazier Suction Tube	Angled Size 11 French	7.25" (18.4cm)
045386	840426	Frazier Suction Tube	Angled Size 12 French	7.25" (18.4cm)
045387	840427	Frazier Suction Tube	Angled Size 14 French	7.25" (18.4cm)
045031	840428	Poole Suction Tube	Angled Size 23 French	8.75" (22.2cm)
045082	840429	Poole Suction Tube	Angled Size 30 French	8.75" (22.2cm)
045032	840430	Yankauer Suction Tube	With Removable Tip	11.75" (30cm)

Hooks



Snook



Covault Ovariectomy



Gillies



Joseph, Sharp Single Prong



Joseph, Double Prong



MWI#	SECUROS#	PRODUCT	FEATURE	SIZE
042164	816370	Snook Hook	Blunt	8" (20.3cm)
045388	840431	Covault Ovariectomy Hook	Blunt	8" (20.3cm)
049225	840433	Gillies Hook	Small	7.25" (18.4cm)
049226	840434	Gillies Hook	Large	7.25" (18.4cm)
049227	840435	Joseph Hook	Sharp Single Prong	6" (15.2cm)
045297	840436	Joseph Hook	Double Prong - 2mm Wide	6" (15.2cm)
049228	840437	Joseph Hook	Double Prong - 5mm Wide	6" (15.2cm)

Nail Clippers



MWI#	SECUROS#	PRODUCT	SIZE
■	840432	White Toe Nail Clippers	4.5" (11.5cm)

Percussion Hammers



MWI#	SECUROS#	PRODUCT	SIZE
049660	840438	Taylor Percussion Hammer	6.5" (16.5cm)
049229	840439	Taylor Percussion Hammer	7.5" (19.1cm)

Young Tongue Forceps



Young Tongue

MWI#	SECUROS#	PRODUCT	SIZE
049230	840440	Young Tongue Forceps	6.25" (15.8cm)

Directors



MWI#	SECUROS#	PRODUCT	SIZE
049231	840441	Grooved Director	4.5" (11.5cm)
045298	840442	Grooved Director	5" (12.7cm)
049232	840443	Grooved Director	5.5" (14cm)
■	840444	Grooved Director	6" (15.2cm)

Probes



MWI#	SECUROS#	PRODUCT	SIZE
■	840445	Probe with Eye	4.5" (11.5cm)
■ 370240	840446	Probe with Eye	5" (12.7cm)
049234	840447	Probe with Eye	5.5" (14cm)
048831	840448	Probe with Eye	6" (15.2cm)
■	840449	Probe with Eye	8" (20.3cm)
049235	840450	Probe with Eye	10" (25.4cm)

Scoops



Ferguson Gall Stone



Mayo Common Duct

MWI#	SECUROS#	PRODUCT	FEATURE	SIZE
045004	840452	Ferguson Gall Stone Scoop	Double Ended, 8.5x10.5mm	9.5" (24.1cm) Small
045299	840453	Ferguson Gall Stone Scoop	Double Ended, 11.5x12.5mm	9.5" (24.1cm) Medium
045033	840454	Ferguson Gall Stone Scoop	Double Ended, 12.5x13mm	9.5" (24.1cm) Large
049236	840455	Mayo Common Duct Scoop	Malleable	10.5" (26.7cm) Small
049237	840456	Mayo Common Duct Scoop	Malleable	10.5" (26.7cm) Medium
049238	840457	Mayo Common Duct Scoop	Malleable	10.5" (26.7cm) Large

Speculums



Killian



Vienna

MWI#	SECUROS#	PRODUCT	FEATURE	SIZE
048402	840461	Killian Speculum	51mm	5" (12.7cm)
048404	840462	Killian Speculum	76mm	5" (12.7cm)
■	840463	Killian Speculum	89mm	5" (12.7cm)
■	840458	Vienna Speculum	Small, 25mm	5.75" (14.6cm)
048400	840459	Vienna Speculum	Medium, 30mm	5.75" (14.6cm)
048401	840460	Vienna Speculum	Large, 35mm	5.75" (14.6cm)

Mouth Gags



3.0"



4.5"



5.75"



6.75"

MWI#	SECUROS#	PRODUCT	FEATURE	SIZE
045350	840464	Canine Spring Action Mouth Gag	Small, Lightweight	3.0" (7.6cm)
045005	840465	Canine Spring Action Mouth Gag	Medium	4.5" (11.5cm)
045006	840466	Canine Spring Action Mouth Gag	Large	5.75" (14.6cm)
045389	840467	Canine Spring Action Mouth Gag	X-Large	6.75" (17.1cm)

■ special order item

Tourniquets



MWI#	SECUROS#	PRODUCT
039518	840468	Nye Quick-Lock Tourniquet

Finger Ring Cutters



MWI#	SECUROS#	PRODUCT	FEATURE
048403	840469	Finger Ring Cutter with Blade	Chrome Plated
048405	840470	Finger Ring Cutter Blade	Chrome Plated

Cutaneous Punches



Keys Cutaneous

MWI#	SECUROS#	PRODUCT	FEATURE	SIZE
■	840472	Keys Cutaneous Punch	2mm Tip	4" (10.2cm)
048407	840473	Keys Cutaneous Punch	3mm Tip	4" (10.2cm)
048408	840474	Keys Cutaneous Punch	4mm Tip	4" (10.2cm)
048406	840471	Keys Cutaneous Punch	6mm Tip	4" (10.2cm)
048409	840475	Keys Cutaneous Punch	8mm Tip	4" (10.2cm)

■ special order item

Billeau Ear Loops



MWI#	SECUROS#	PRODUCT	FEATURE	SIZE
044976	814650	Billeau Ear Loop	Small Flexible	6" (15.2cm)
039519	840476	Billeau Ear Loop	Medium Flexible	6" (15.2cm)
048410	840477	Billeau Ear Loop	Large Flexible	6" (15.2cm)

Buck Ear Currettes



Blunt



Sharp

MWI#	SECUROS#	PRODUCT	FEATURE	SIZE
048411	840478	Buck Ear Curette Straight Blunt	Size 00	6.5" (16.5cm)
045351	840479	Buck Ear Curette Straight Blunt	Size 0	6.5" (16.5cm)
048412	840480	Buck Ear Curette Straight Blunt	Size 1	6.5" (16.5cm)
045352	840481	Buck Ear Curette Straight Blunt	Size 2	6.5" (16.5cm)
045353	840482	Buck Ear Curette Straight Blunt	Size 3	6.5" (16.5cm)
048413	840483	Buck Ear Curette Straight Sharp	Size 00	6.5" (16.5cm)
045354	840484	Buck Ear Curette Straight Sharp	Size 0	6.5" (16.5cm)
048414	840485	Buck Ear Curette Straight Sharp	Size 1	6.5" (16.5cm)
045034	840486	Buck Ear Curette Straight Sharp	Size 2	6.5" (16.5cm)
045355	840487	Buck Ear Curette Straight Sharp	Size 3	6.5" (16.5cm)

Forceps



Bunt Forceps Holder



Hartmann Alligator, Serrated



Hartmann Alligator, Round Cup Jaws



Hartmann Alligator, 1x2 Teeth



Jansen Bayonet



Lucae

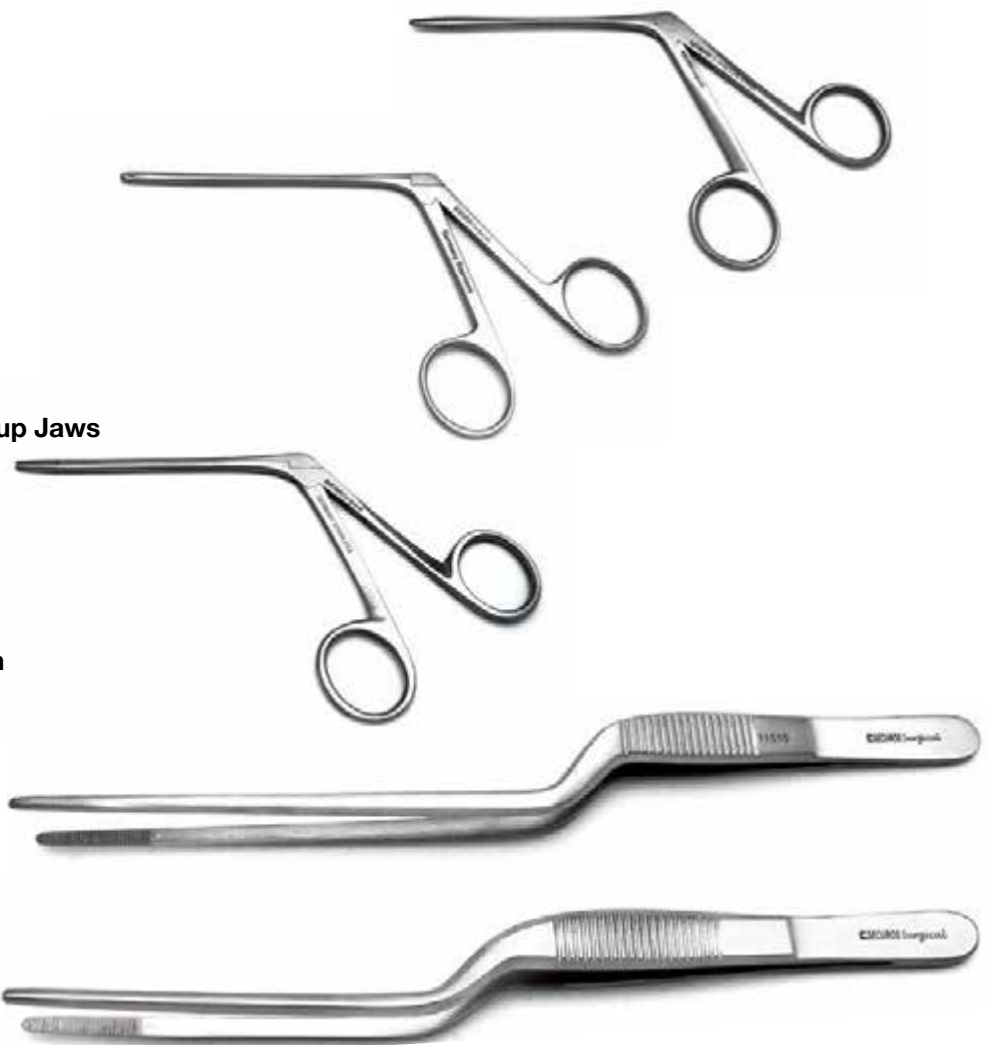

MWI#	SECUROS#	PRODUCT	FEATURE	SIZE
045035	840505	Bunt Forceps Holder	6/pkg.	
048417	840490	Hartmann Alligator Forceps	Serrated Jaw	3.5" (8.9cm)
047168	840491	Hartmann Alligator Forceps	Serrated Jaw	5.5" (14cm)
045356	840492	Hartmann Alligator Forceps	Serrated Jaw	6.5" (16.5cm)
048118	840493	Hartmann Alligator Forceps	2mm cup	3.5" (8.9cm)
048832	840494	Hartmann Alligator Forceps	1x2 Teeth	3.5" (8.9cm)
048416	840489	Jansen Bayonet Forceps	Serrated Jaw	6.5" (16.5cm)
048415	840488	Lucae Forceps	Serrated Jaw	5.75" (14.6cm)

Clamps

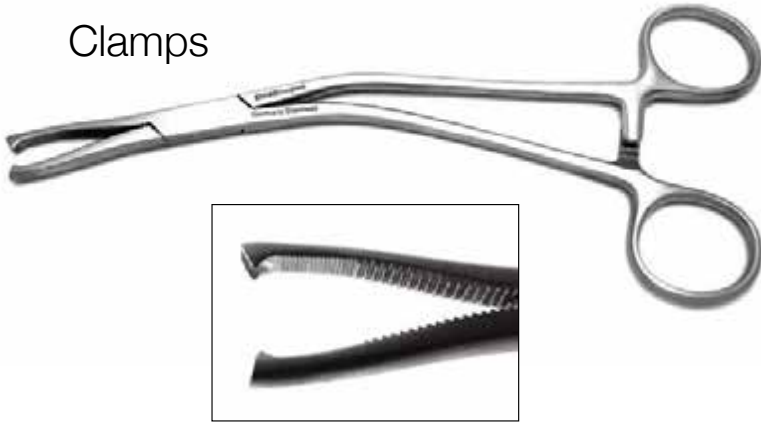

Dingman Cartilage and Bone Clamp



Martin Cartilage Clamp

MWI#	SECUROS#	PRODUCT	SIZE
045288	840385	Martin Cartilage Clamp	8"
090031	840347	Dingman Cartilage and Bone Clamp 2 x 2	7.5"



Satinsky Clamp, Straight



Satinsky Clamp, Curved, Atraumatic

MWI#	SECUROS#	PRODUCT	FEATURE	SIZE
055021	003927	Satinsky Clamp	Straight	6"
048317	003391	Satinsky Clamp	Curved, Atraumatic	8"

Instrument Stringers

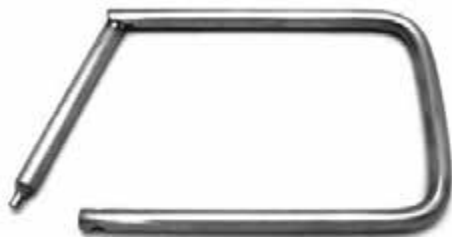

End-Gate

MWI#	SECUROS#	PRODUCT	SIZE
048419	840503	T-Shaped Stringer	6"
■	840504	End-Gate Stringers	2.5" x 4"
■	840720	End-Gate Stringers	2.5" x 6"
045367	840721	End-Gate Stringers	2.5" x 8"
382632	840722	End-Gate Stringers	2.5" x 10"
048624	840723	End-Gate Stringers	2.5" x 12"



T-Shaped

MWI#	SECUROS#	PRODUCT	SIZE
048625	840724	End-Gate Stringers	2.5" x 14"
048626	840725	End-Gate Stringers	2.5" x 16"
048627	840726	End-Gate Stringers	2.5" x 18"
048628	840727	End-Gate Stringers	2.5" x 20"
048629	840278	End-Gate Stringers	2.5" x 18"
048630	840729	End-Gate Stringers	2.5" x 20"

■ special order item

SURGICAL INSTRUMENTS

Ophthalmic

Eye Packs.....	395
Forceps.....	396
Needle Holders.....	398
Speculums.....	398
Retractors.....	399
Eye Dressing Forceps.....	399
Iris Tissue Forceps.....	400
Jeweler's Forceps.....	401
Desmarres Chalazion Forceps.....	401



Eye Packs



STARTER EYE PACK

German Starter Eye Pack
MWI# 048906, SECUROS #840690

Includes:

MWI#	SECUROS#	PRODUCT
045314	840130	(1) Derf Needle Holder 4.75"
045007	840513	(1) Bishop-Harmon Forceps 3.25", 1X2 Teeth Delicate
043923	840522	(1) Barraquer Wire Eye Speculum 1.5", Blades 10.5mm
045071	840016	(1) Stevens Tenotomy Scissors, Curved 4.25"



ADVANCED EYE PACK

German Advanced Eye Pack
MWI# 055135, SECUROS #840693

Includes:

MWI#	SECUROS#	PRODUCT
031033	001310	Micro Blade Handle
045007	840513	Bishop Harmon Forceps, 1X2 Teeth, 3.25", Delicate
045359	840534	Desmarres Chalazion Forceps, 20mm Wide, 3.5"
045071	840016	Stevens Tenotomy Scissor, Curved, 4.25"
043923	840522	Barraquer Wire Eye Speculum 1.5", Blades 10.5mm
055070	840163	Castroviejo Needleholder with Lock Smooth Jaw, 5.5"
031138	001312	Microbeaver Blade, Size 6700, Box of 12
045314	840130	Derf Needle Holder, 4.75"



German Starter Eye Pack with Case
MWI# 049687, SECUROS #840907

Includes:

MWI#	SECUROS#	PRODUCT
045314	840130	(1) Derf Needle Holder, 4.75"
045007	840513	(1) Bishop-Harmon Forceps, 3.25", 1X2 Teeth Delicate
043923	840522	(1) Barraquer Wire Eye Speculum, 1.5", Blades 10.5mm
045071	840016	(1) Stevens Tenotomy Scissors, Curved, 4.25"
048833	840770	(1) Sterilization Case w/Mat



German Advanced Eye Pack with Case
MWI# 049686, SECUROS #840908

Includes:

MWI#	SECUROS#	PRODUCT
031033	001310	(1) Micro Blade Handle
045007	840513	(1) Bishop Harmon Forceps, 1X2, Teeth 3.25" Delicate
045359	840534	(1) Desmarres Chalazion Forceps, 20mm Wide, 3.5"
045071	840016	(1) Stevens Tenotomy Scissor, Curved, 4.25"
043923	840522	(1) Barraquer Wire Eye Speculum, 1.5", Blades 10.5mm
055070	840163	(1) Castroviejo Needleholder with Lock Smooth Jaw, 5.5"
031138	001312	(1) Microbeaver Blade, Size 6700, Box of 12
045314	840130	(1) Derf Needle Holder, 4.75"
048833	840770	(1) Sterilization Case w/Mat

Forceps



Troutman-Barraquer



Graefe Fixation



Graefe Fixation with Catch



Bishop-Harmon Extra Delicate



Bishop-Harmon delicate



MWI#	SECUROS#	PRODUCT	FEATURE	SIZE
048421	840507	Troutman-Barraquer Colibri Corneal Forceps	1x2, 0.4mm Teeth with Tying Platform	3" (7.6cm)
045357	840508	Troutman-Barraquer Colibri Corneal Forceps	1x2, 12mm Teeth with Tying Platform	3" (7.6cm)
048422	840509	Graefe Fixation Forceps	4.5mm wide, fine teeth	4.25" (10.8cm)
045036	840510	Graefe Fixation Forceps	4.5mm wide, fine teeth, with catch	4.25" (10.8cm)
045037	840511	Bishop-Harmon Forceps	Extra Delicate Serrated Jaws	3.5" (8.9cm)
044042	840512	Bishop-Harmon Forceps	Delicate Serrated Jaws	3.5" (8.9cm)
045007	840513	Bishop-Harmon Forceps	1x2 Teeth Delicate	3.25" (8.2cm)

Forceps

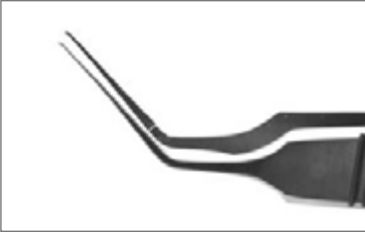

Utrata Capsulorhexis Forceps 3.25"

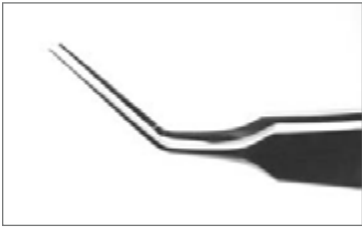

Utrata Capsulorhexis Forceps 4.25"

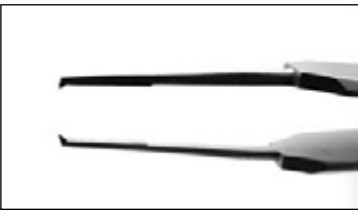

Castroviejo Suturing, Straight



Castroviejo Suturing, Curved



MWI#	SECURUS#	PRODUCT	FEATURE	SIZE
049150	830034	Utrata Capsulorhexis Forceps	Delicate Angled Tip	3.25" (8.2cm)
045374	840789	Utrata Capsulorhexis Forceps	Delicate Angled Tip	4.25" (10.8cm)
048423	840514	Castroviejo Suturing Forceps	Straight, 0.6mm tip with tying platform	4.125" (10.5cm)
048424	840515	Castroviejo Suturing Forceps	Curved, 0.6mm tip with tying platform	4.125" (10.5cm)

Needle Holders



Castroviejo Needle Holder, Standard

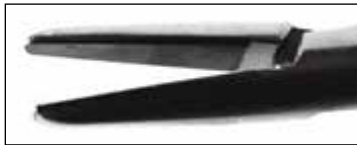

Castroviejo Needle Holder, Straight, TC



Barraquer Needle Holder, Curved



MWI#	SECUROS#	PRODUCT	FEATURE	SIZE
055070	840163	Castroviejo Needle Holder	Straight, Smooth Jaws with Lock	5.5" (14cm)
044986	840164	Castroviejo Needle Holder	Straight, Smooth Tungsten Carbide Jaws with Lock	5.5" (14cm)
048827	816420	Barraquer Needle Holder	Straight, Smooth Jaws with Lock	5.5" (14cm)
■ 276428	816400	Barraquer Needle Holder	Curved, Smooth Jaws with Lock	5.5" (14cm)

Speculums

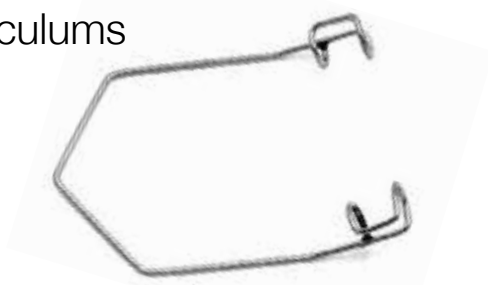

Barraquer



Castroviejo

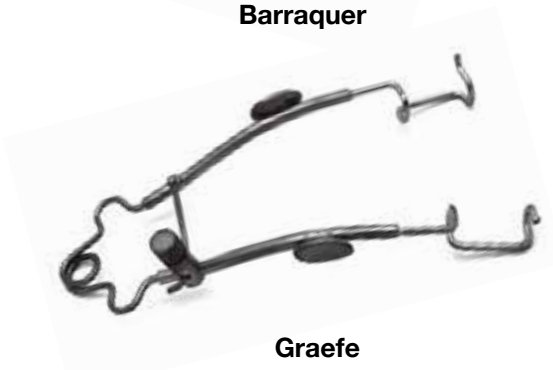

Graefe



Lancaster

MWI#	SECUROS#	PRODUCT	SIZE
043923	840522	Barraquer Eye Speculum (Colibri)	1.25" (3.1cm) Blades 10.5mm
045358	840523	Barraquer Eye Speculum (Colibri)	1.5" (3.8cm) Blades 13.0mm
048427	840521	Castroviejo Eye Speculum	3.25" (8.2cm)
048426	840520	Graefe Eye Speculum	3.5" (8.9cm) Adult
048425	840519	Lancaster Eye Speculum	2.75" (7cm)

■ special order item

Retractors

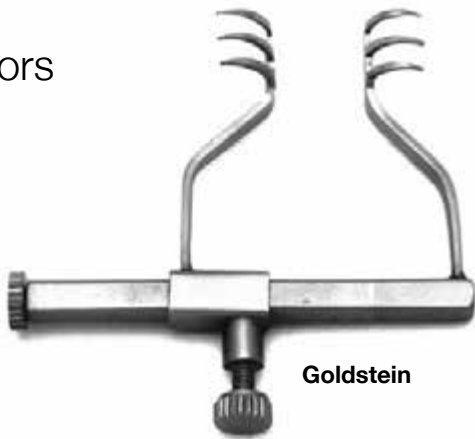

Goldstein



Desmarres

MWI#	SECUROS#	PRODUCT	SIZE
048428	840524	Goldstein Eye Retractor	1.25" (3.1cm)
045050	840801	Desmarres Eyelid Retractor	5.25" (13.3cm)

Eye Dressing Forceps



Straight



Half Curved



Full Curved



MWI#	SECUROS#	PRODUCT	FEATURE	SIZE
048429	840525	Eye Dressing Forceps	Straight, Serrated Tips	4" (10.2cm)
048430	840526	Eye Dressing Forceps	Half Curved, Serrated Tips	4" (10.2cm)
048431	840527	Eye Dressing Forceps	Full Curved, Serrated Tips	4" (10.2cm)

Iris Tissue Forceps

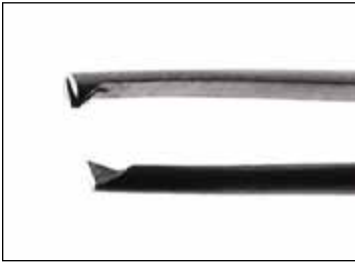

Straight



Half Curved



Full Curved



MWI#	SECUROS#	PRODUCT	FEATURE	SIZE
048432	840528	Iris Tissue Forceps	Straight 1x2 Teeth	4" (10.2cm)
048433	840529	Iris Tissue Forceps	Half Curved 1x2 Teeth	4" (10.2cm)
048434	840530	Iris Tissue Forceps	Full Curved 1x2 Teeth	4" (10.2cm)

Jeweler's Forceps



Fine Points, Angled Pick-up



Sharp Points, Curved



MWI#	SECUIROS#	PRODUCT	FEATURE	SIZE
048435	840531	Jeweler's Forceps #5 Swiss Style	Fine Points, Angled Pick-Up	4.5" (11.5cm)
045412	840532	Jeweler's Forceps #7 Swiss Style	Sharp Points, Curved	4.75" (12.1 cm)

Desmarres Chalazion Forceps



MWI#	SECUIROS#	PRODUCT	FEATURE	SIZE
048436	840533	Desmarres Chalazion Forceps	16mm Wide	3.5" (8.9cm)
045359	840534	Desmarres Chalazion Forceps	26mm Wide	3.5" (8.9cm)
045360	840535	Desmarres Chalazion Forceps	30mm Wide	3.5" (8.9cm)

SURGICAL INSTRUMENTS

Dental

Probes & Explorers	403	Elevators & Picks	408
Scalers.....	403	Extracting Forceps.....	409
Curettes.....	404	Chisels	411
Mirrors.....	406	Files.....	411
Elevators	407	Dental Instrument Packs.....	412



Probes & Explorers

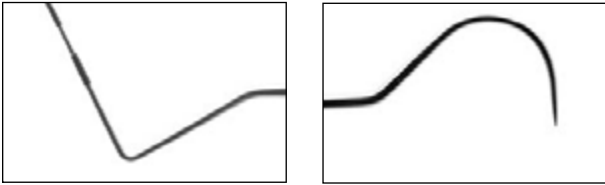

Probe/Explorer Handle

MWI#	SECUROS#	PRODUCT
045413	840536	Probe/Explorer Double Ended 3, 6, 9, 12mm markings

Scalers

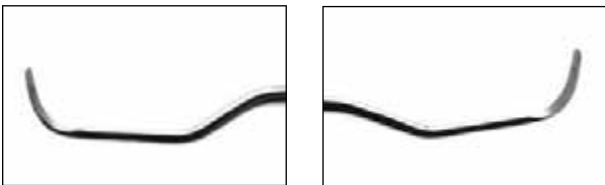

Scaler H 6/7

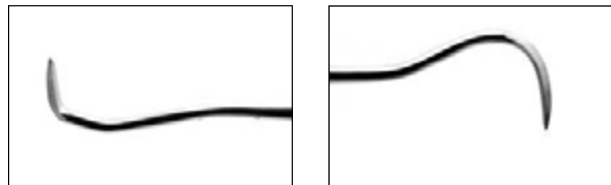

Jacquette Scaler 33/U15

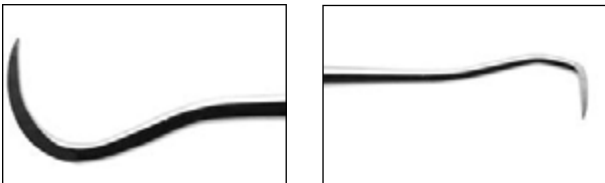

Jacquette Scaler 33/H5

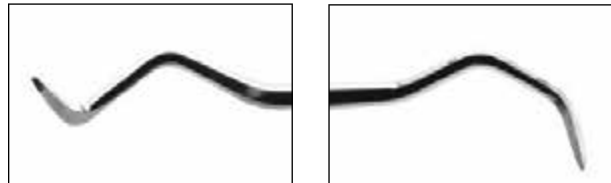

Jacquette Scaler 2S/3S



Jacquette Scaler 2/3

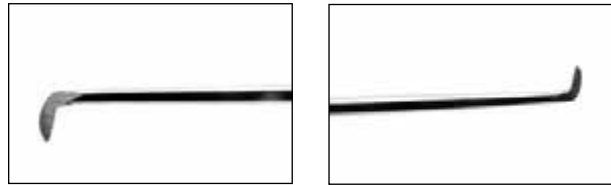

Morse Scaler 0-00



Jacquette Scaler 20/33



Scaler Handle

MWI#	SECUROS#	PRODUCT
048438	840539	Scaler H 6/7
045414	840537	Jacquette Scaler 33/H5
039520	840540	Jacquette Scaler 2/3
045415	840541	Jacquette Scaler 20/33
045416	840542	Jacquette Scaler 33/U15
045417	840543	Jacquette Scaler 2S/3S
048437	840538	Morse Scaler 0-00



Curettes

MWI#	SECUROS#	PRODUCT
045418	840544	Gracey Curette 1/2
045419	840545	Gracey Curette 3/4
045420	840546	Gracey Curette 5/6
045421	840547	Gracey Curette 7/8
045422	840548	Gracey Curette 9/10
045423	840549	Gracey Curette 11/12
045424	840550	Gracey Curette 13/14
045425	840551	Gracey Curette 15/16
045426	840552	Gracey Curette 17/18
045427	840553	Gracey Curette 11/14
045428	840554	Gracey Curette 12/13
045429	840555	Columbia Curette 13/14
045038	840556	McCalls Curette 11/12
045450	840557	McCalls Curette 13/14
045451	840558	McCalls Curette 17/18
048835	840559	Hirschfeld File 3-7
048439	840560	Hirschfeld File 5-11
048440	840561	Hirschfeld File 9-10
048455	840598	Lucas Curette No. 85 Angular, Small
048456	840599	Lucas Curette No. 86 Angular, Medium
048457	840600	Lucas Curette No. 87 Angular, Large

Curette Handle

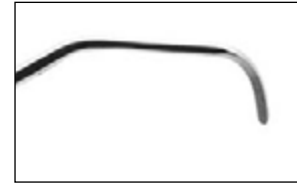
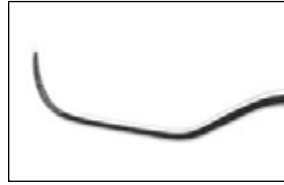

Gracey 1/2

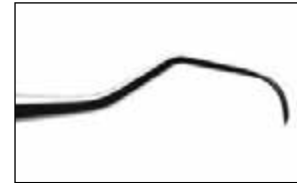

Gracey 3/4

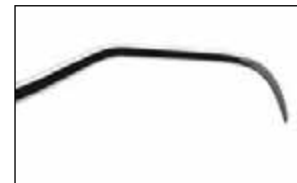

Gracey 5/6

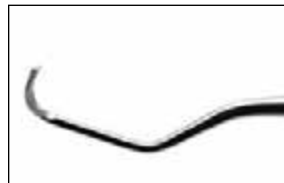

Gracey 7/8

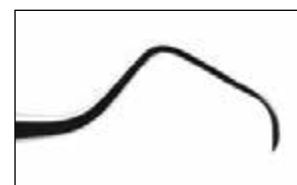
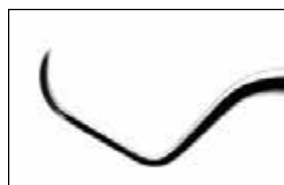

Gracey 9/10

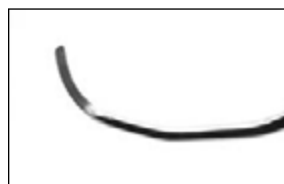

Gracey 11/12

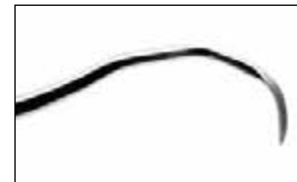
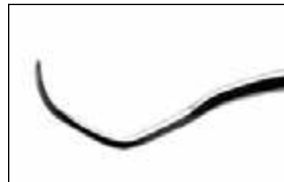

Gracey 13/14

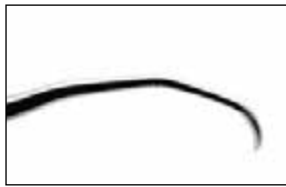
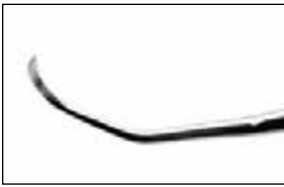

Gracey 15/16

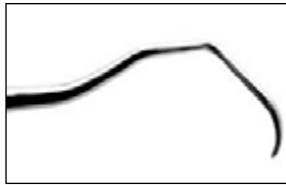

Gracey 17/18

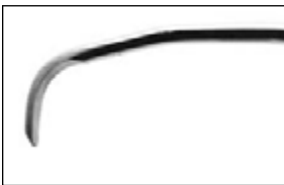

Gracey 11/14



Gracey 12/13

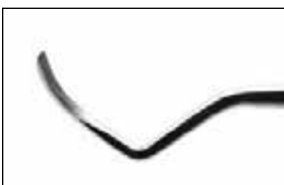

Columbia Curette 13/14

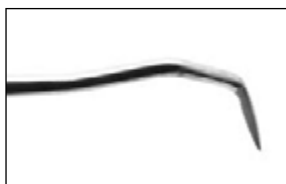

Mccalls 11/12

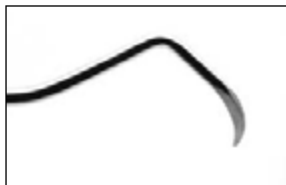
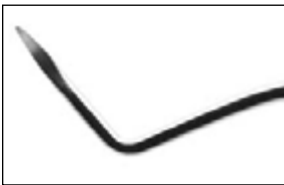

Mccalls 13/14



Mccalls 17/18

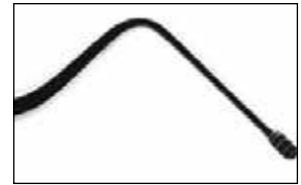

Hirschfeld 3-7

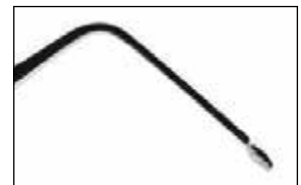
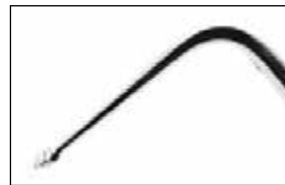

Hirschfeld 5-11



Hirschfeld 9-10

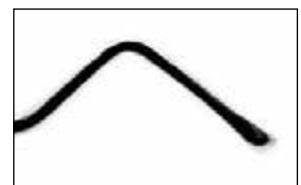

Lucas no. 85

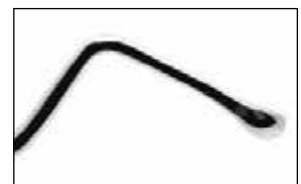

Lucas no. 86



Lucas no. 87

Mirrors



MWI#	SECUROS#	PRODUCT	FEATURE
■	840562	Dental Laryngeal Mirror	Size 0, 12mm
048443	840563	Dental Laryngeal Mirror	Size 1, 16mm
048836	840564	Dental Laryngeal Mirror	Size 2, 18mm
048837	840565	Dental Laryngeal Mirror	Size 3, 20mm
048838	840566	Dental Laryngeal Mirror	Size 4, 22mm
048444	840567	Dental Laryngeal Mirror	Size 5, 24mm
048445	840568	Dental Laryngeal Mirror	Size 6, 26mm



SIZE 0



SIZE 1



SIZE 2



SIZE 3



SIZE 4



SIZE 5



SIZE 6

■ special order item

Elevators



Luxating, Curved

Luxating, Straight



Winged Tip



Apical 301



Apical 302



Apical 303



34S Elevator



Molt #9 Periosteal

MWI#	SECUROS#	PRODUCT	SIZE
045452	840569	Luxating Elevator Curved Tip 2mm	5.75"
045453	840570	Luxating Elevator Curved Tip 3mm	5.75"
045454	840571	Luxating Elevator Curved Tip 4mm	5.75"
045455	840572	Luxating Elevator Curved Tip 5mm	5.75"
045456	840573	Luxating Elevator Straight Tip 2mm	5.75"
045457	840574	Luxating Elevator Straight Tip 3mm	5.75"
045458	840575	Luxating Elevator Straight Tip 4mm	5.75"
045459	840576	Luxating Elevator Straight Tip 5mm	5.75"
045460	840577	Winged Tip Elevator 2mm	4.75"
045461	840578	Winged Tip Elevator 3mm	4.75"
054462	840579	Winged Tip Elevator 4mm	4.75"
045463	840580	Winged Tip Elevator 5mm	4.75"

MWI#	SECUROS#	PRODUCT	SIZE
045464	840581	Winged Tip Elevator 6mm	4.75"
045465	840582	Winged Tip Elevator 7mm	4.75"
045466	840583	Winged Tip Elevator 8mm	4.75"
045467	840584	301 Apical Elevator - Straight	5.75"
045468	840585	302 Apical Elevator - Left Angle	5.75"
045469	840586	303 Apical Elevator - Right Angle	5.75"
045482	840587	34 Elevator 4.5mm Tip	6"
039521	840588	34S Elevator 3.5 mm Tip	6"
039522	840589	46 Elevator 3.0mm Tip	5.75"
048454	840597	Molt #9 Periosteal Elevator	5.75"

Elevators & Picks



78 Root Tip, Straight



79 Root Tip, Curved Right



80 Root Tip, Curved Left



Heidbrink Root, Straight



Heidbrink Root, Left



Heidbrink Root, Double Ended



Heidbrink Root, Right

MWI#	SECUROS#	PRODUCT	SIZE
039523	840590	78 Root Tip Elevator	6.0"
048446	840591	79 Root Tip Elevator Curved Right	5.5"
048447	840592	80 Root Tip Elevator Curved Left	5.5"
048450	840593	Heidbrink Root Tip Pick Delicate, Straight	5.25"
048451	840594	Heidbrink Root Tip Pick Delicate, Left	5.25"
048452	840595	Heidbrink Root Tip Pick Delicate, Double Ended	7.75"
048453	840596	Heidbrink Root Tip Pick Delicate, Right	5.25"

Extracting Forceps



Universal 17S



Universal 150S



Universal 151S



Tarter Removing Forceps

MWI#	SECUROS#	PRODUCT	FEATURE	SIZE
048458	840601	Universal Extracting Forceps	17S	4.5" (11.4cm)
046546	840602	Universal Extracting Forceps	150S	6" (15.2cm)
045119	840603	Universal Extracting Forceps	151S	5.75" (14.6cm)
090055	840880	Tarter Removing Forceps		4.75" (12.1cm)

Extracting Forceps



Standard #1



Standard #62



Standard #150



Standard #151

MWI#	SECUROS#	PRODUCT	FEATURE	SIZE
048459	840604	Standard Extracting Forceps	#1	6.5" (16.5cm)
048460	840605	Standard Extracting Forceps	#62	6.5" (16.5cm)
048461	840606	Standard Extracting Forceps	#150	6.5" (16.5cm)
048462	840607	Standard Extracting Forceps	#151	6.5" (16.5cm)

Chisels

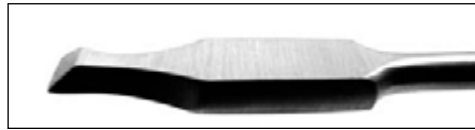

Ochsenbein Chisel #1

Ochsenbein Chisel #2

MWI#	SECUROS#	PRODUCT	SIZE
048840	840613	Ochsenbein Chisel #1	6.75" (17.1cm)
048841	840616	Ochsenbein Chisel #2	6.75" (17.1cm)

Files



Bone File Handle



Bone File #10

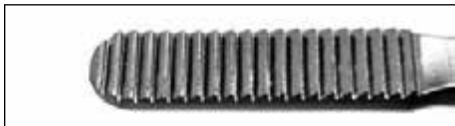

Bone File #33

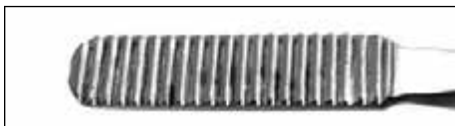

Bone File #64



Bone File #45



Bone File #12

MWI#	SECUROS#	PRODUCT	FEATURE	SIZE
048463	840608	Bone File No. 10	Double Ended	7" (17.8cm)
048464	840609	Bone File No. 33	Double Ended	7" (17.8cm)
048465	840610	Bone File No. 64	Double Ended	7" (17.8cm)
048466	840611	Bone File No. 45	Double Ended	7" (17.8cm)
045525	840612	Bone File No. 12	Double Ended	7" (17.8cm)

Instrument Packs



Periodontal Instrument Pack MWI# 033444, SECUROS #810002

Includes:

MWI#	SECUROS#	PRODUCT
048838	840566	Dental Laryngeal Mirror Size 4#, 22mm
048837	840565	Dental Laryngeal Mirror Size 4#, 20mm
045413	840536	Periodontal Explorer Double Ended
045414	840537	Jacquette Scaler #33-H5
048437	840538	Morse Scaler #0-00
045429	840555	Columbia Curette #13/14
045418	840544	Gracey Curette #1/2
090057	840913	Test Stick 75mm
048254	003733	Sharpening Stone #299
049500	003732	Sharpening Stone Arkansas
045620	002751	Cleaning/Storage Cassette, with Mat

Prophylaxis Pack MWI# 382850, SECUROS #840875

Includes:

MWI#	SECUROS#	PRODUCT
048838	840566	Dental Laryngeal Mirror Size 4, 22mm
045450	840557	McCall Scaler 13s/14s
045413	840536	Probe/Explorer
039520	840540	Jacquette Scaler
045416	840542	Jacquette Scaler
045620	002751	Cleaning/Storage Cassette with Mat



Prophylaxis Pack without Case MWI# 382851, SECUROS #840876

Includes:

MWI#	SECUROS#	PRODUCT
048838	840566	Dental Laryngeal Mirror Size 4, 22mm
045450	840557	McCall Scaler 13s/14s
045413	840536	Probe/Explorer
039520	840540	Jacquette Scaler
045416	840542	Jacquette Scaler

Winged Tip Elevator Pack MWI# 055136, SECUROS #840873

Includes:

MWI#	SECUROS#	PRODUCT
045460	840577	Winged Tip Elevator 2mm
045461	840578	Winged Tip Elevator 3mm
048383	840579	Winged Tip Elevator 4mm
045463	840580	Winged Tip Elevator 5mm
045464	840581	Winged Tip Elevator 6mm
045465	840582	Winged Tip Elevator 7mm
045466	840583	Winged Tip Elevator 8mm
048843	840870	Universal Dental Tray - 11.5" x 7" x 1.4" Stainless Steel, Rubber Handles

Instrument Packs



Winged Tip Elevator Pack without Case
MWI# 382849, SECUROS #840874

Includes:

MWI#	SECUROS#	PRODUCT
045460	840577	Winged Tip Elevator 2mm
045461	840578	Winged Tip Elevator 3mm
048383	840579	Winged Tip Elevator 4mm
045463	840580	Winged Tip Elevator 5mm
045464	840581	Winged Tip Elevator 6mm
045465	840582	Winged Tip Elevator 7mm
045466	840583	Winged Tip Elevator 8mm



Luxating Tip Elevator Pack Straight
MWI# ■, SECUROS #840911

Includes:

MWI#	SECUROS#	PRODUCT
045456	840573	Luxating Elevator Straight Tip 2mm
045457	840574	Luxating Elevator Straight Tip 3mm
045458	840575	Luxating Elevator Straight Tip 4mm
045459	840576	Luxating Elevator Straight Tip 5mm
045620	002751	Instrument Case - 8" x 4.75", Stainless Steel Case, Silicone Mat



Luxating Tip Elevator Pack Curved
MWI# ■, SECUROS #840910

Includes:

MWI#	SECUROS#	PRODUCT
045452	840569	Luxating Elevator Curved Tip 2mm
045453	840570	Luxating Elevator Curved Tip 3mm
045454	840571	Luxating Elevator Curved Tip 4mm
045455	840572	Luxating Elevator Curved Tip 5mm
045620	002751	Instrument Case - 8" x 4.75", Stainless Steel Case, Silicone Mat



Luxating Tip Combo Pack
MWI# ■, SECUROS #840912

Includes:

MWI#	SECUROS#	PRODUCT
045456	840573	Luxating Elevator Straight Tip 2mm
045457	840574	Luxating Elevator Straight Tip 3mm
045458	840575	Luxating Elevator Straight Tip 4mm
045459	840576	Luxating Elevator Straight Tip 5mm
045452	840569	Luxating Elevator Curved Tip 2mm
045453	840570	Luxating Elevator Curved Tip 3mm
045454	840571	Luxating Elevator Curved Tip 4mm
045455	840572	Luxating Elevator Curved Tip 5mm
048843	840870	Universal Dental Tray - 11.5" x 7" x 1.4", Stainless Steel, Rubber Holders

■ special order item

SURGICAL INSTRUMENTS

Instrument Packs & Storage

Orthopedic Instrument Pack..... 415

Spay Packs 416

General Surgery Pack..... 415

Storage..... 417



Orthopedic Instrument Pack



Orthopedic Instrument Pack MWI# 033448, SECUROS #810006

Includes:

MWI#	SECUROS#	PRODUCT
030961	815750	(2) SENN Retractors Sharp, 6.25"
044987	840182	(1) Weitlaner Retractor Sharp ,5.5"
045286	840351	(1) GIGLI Saw Handles Pair
045002	840349	(1) GIGLI Wire Saw, 12"
044999	840321	(1) Kern Bone Holding Forceps, 6"
045019	840322	(1) Kern Bone Holding Forceps, 8"
042163	813670	(1) Mead Mallet, 7.5"
043936	002745	(1) Bone Curette Volkman Double Ended, 6.5" 2mm
029089	001277	(1).035" K-Wire 6 Pack
029090	001278	(1).045" K-Wire 6 Pack
029068	001257	(2) 1/16" Partially Threaded Pins
029073	002957	(2) 9/64" Partially Threaded Pins
029071	001260	(2) 7/64" Partially Threaded Pins
029074	001261	(2) 5/32" Partially Threaded Pins
029070	001259	(2) 3/32" Partially Threaded Pins
029069	001258	(2) 5/64" Partially Threaded Pins
045076	840257	(1) Osteotome Pedifine, 5" 8mm
029522	001488	(1) IM Pin Organizer Bag
029517	001479	(1) Dual Chuck Hand Chuck
045245	840011	(1) Roger Wire Cutting Scissor, 4.75"
045292	840402	(1) Cannulated Pin Cutter, 7.5"
045025	840391	(1) Wire Twister w/Holes, 6.5"
045273	840224	(1) DEAN Rongeur Single Action, 5.75"
029079	001266	(1) 20 gauge Orthopedic Wire, 1oz. Spool
029080	001267	(1) 22 gauge Orthopedic Wire, 1oz. Spool
036188	840352	(1) Fomon Rasp and File, 8.5"
045078	840292	(1) Freer Periosteal Elevator, 7.5" 5mm

General Surgery Pack



General Surgery Pack MWI# 033446, SECUROS #810004

Includes:

MWI#	SECUROS#	PRODUCT
042167	830026	(1) Scalpel Blade Handle #3
033439	801210	(1) Mayo Scissors, 6.75" Straight
033388	802230	(1) Metzenbaum Scissors, 7" Curved
033384	804930	(1) Adson Brown Forceps, 4.75" 7 x 7 Teeth
033382	805570	(3) Halsted Mosquito Forceps, 5" Curved
033389	806470	(4) Rochester Carmalt Forceps, 6.25" Curved
042164	816370	(1) Snook Hook
033397	805760	(2) Kelly Forcep Straight, 5.5"
039506	815940	(4) Backhaus Towel Clamp, 5.25"
033385	810010	(1) Olsen Hegar Needleholder, 6.5" TC
044048	003749	(1) Instrument Case 380 x 212 x 30mm
044060	003760	(1) Silicone 9.25" x 15.5" Mat

Canine Spay Pack



Canine Spay Pack MWI# 033443, SECUROS #810001

Includes:

MWI#	SECUROS#	PRODUCT
042167	830026	(1) Scalpel Handle No. 3
033439	801210	(1) Mayo Scissors 6.75" Straight
033388	802230	(1) Metzenbaum Scissors 7" Curved
033384	804930	(1) Adson-Brown Forceps 7x7 Teeth 4.75"
033382	805570	(4) Halsted Mosquito Forceps 5" Curved
033389	806470	(2) Rochester Carmalt Forceps 6.25" Curved
042164	816370	(1) Snook Hook
033392	815920	(4) Backhaus Towel Clamp 3.5"
055008	840101	(1) Allis Tissue Forceps 4x5 teeth 4.75"
039515	840049	(1) Thumb Tissue Forceps Narrow 1x2 Teeth 5.5"
033397	805780	(2) Kelly Forceps 5.5" Straight
033385	810010	(1) Olsen-Hegar Needle Holder TC 6.5"
044048	003749	(1) Instrument Tray 380mm x 212mm x 30mm
044060	003760	(1) Silicone 9.25" x 15.5" Mat

Feline Spay Pack



Feline Spay Pack MWI# 033445, SECUROS #810003

Includes:

MWI#	SECUROS#	PRODUCT
042167	830026	(1) Scalpel Handle No. 3
033439	801210	(1) Mayo Scissors 6.75" straight
033388	802230	(1) Metzenbaum Scissors 7" curved
033384	804930	(1) Adson Brown Forceps 4.75" 7 x 7 Teeth
033382	805570	(2) Halsted Mosquito Forceps 5" curved
033389	806470	(2) Rochester Carmalt Forceps 6.25" curved
042164	816370	(1) Snook Hook
033392	815920	(4) Backhaus Towel Clamp 3.5"
039504	803380	(1) Allis Tissue Forcep 4x5 teeth 6"
039515	840049	(1) Thumb Tissue Forceps 1x2 teeth 5.5"
033397	805760	(2) Kelly Forceps 5.5" straight
033386	809970	(1) Olsen-Hegar Needle Holder TC 5.5"
044048	003749	(1) Instrument Tray 380mm x 212mm x 30mm
044060	003760	(1) Silicone 9.25" x 15.5" Mat

Sterilization Trays

Stainless Steel Trays



003749



001003



001005

MWI#	SECUROS#	PRODUCT	LENGTH (")	WIDTH (")	HEIGHT (")
044048	003749	Instrument Case	1.5	8.4	1.2
045620	002751	Instrument Case	8	4.75	1.25
048843	840870	Universal Dental Tray, Rubber Holders	11.5	7	1.4
031093	001005	Perforated Tray	12.25	7.75	2.25
042046	000513	Perforated Tray	10	6.5	2
045520	001350	Perforated Tray	9	5	2
029096	001003	Small Sterilization Tray	1.75	2.75	3/8
044060	003760	Silicone Mat	9.25	15.5	-

Plastic Cases (Includes Silicone Mat)



840770



001330



001332



001331

MWI#	SECUROS#	LENGTH (")	WIDTH (")	HEIGHT (")
■ 276469	004176	7	2	.75
048833	840770	7.75	4.25	1
043918	001330	11.25	6.75	2
045114	001332	15	10	2.5
045434	001331	20.75	10	2.5

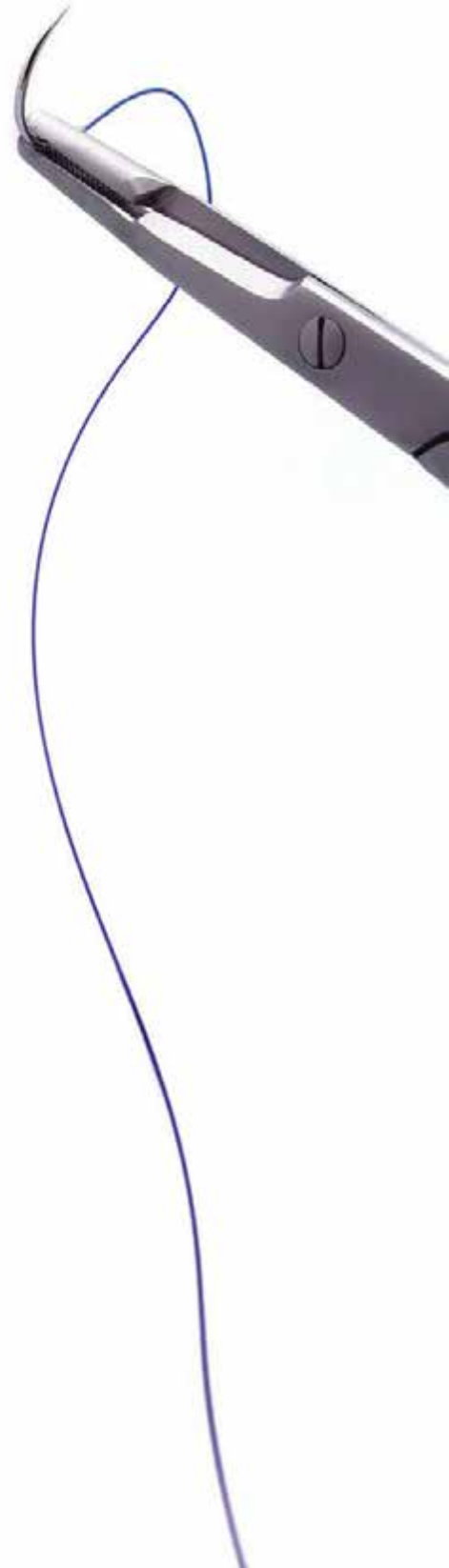

SURGICAL Sutures

SECUROALLOY™ 300 Series Needles	420
Absorbable & Nonabsorbable Sutures	421
Swaged-on Suture Products	423
Ophthalmic Codes	424
Specialty Products.....	424
Cassettes.....	425
Needles.....	427

VISIPRO™

Fluorescent Monofilament Polypropylene Suture

See the difference under black light?

2/0 VISIPRO

2/0 Nylon

- **Fluoresces** under black light.
- **Bright** magenta color.
- **Polypropylene** for smooth tissue passage and excellent knot security.
- Great for dark-coated animals.
- Available in **Swaged-on**—packaged in SECUROTRAC™ for less memory—or **Cassette**.



SECUROALLOY™ 300 Series Needles

3/8 Circle Reverse Cutting ▾	
	FS-2 19mm
	FS-1 24mm
	FS 26mm
	FSL 30mm
	FSLX 40mm

1/2 Circle Reverse Cutting ▾	
	X-1 22mm
	CP-2 26mm
	CP-1 37mm
	CP 40mm

3/8 Circle Premium Reverse Cutting ▾	
	P-1 11mm
	P-3 13mm
	PS-2 19mm
	PS-1 24mm

1/2 Circle Taper Point ○	
	RB-1 17mm
	SH-1 22mm
	SH 26mm
	MO-6 26mm
	CT-2 27mm
	CT-1 36mm

Spatula ▾	
	CS160-8 5.5mm 1/2 Circle
	S-29 8.0mm 1/4 Circle
	TG140-8 6.5mm 3/8 Circle

1/2 Circle Premium Taper ○	
	V-34 36mm

Straight Reverse Cutting ▾	
	KS 60mm

Additional Needles Include LR, TP-1 and CCS-1

Absorbable Suture Characteristics

SECURODOX™ (Violet Monofilament PDO)

Advantages

- Monofilament
- Minimal Tissue Drag
- Predictable Absorption
- Prolonged Strength

Tensile Strength

- 80% at 14 days
- 70% at 28 days
- 60% at 42 days
- Complete Absorption at 180 days plus

SECUROCRYL™ (Violet Monofilament PGCL)

Advantages

- Monofilament
- Smooth Tissue Passage
- Excellent Handling
- Superb Knot Security
- Predictable Absorption

Tensile Strength

- 50-60% at 7 days
- 30-40% at 14 days
- Complete Absorption at 90 days plus

SECUROSORB™ (Coated Braided PGLA)

Advantages

- Coated Braided
- Predictable Absorption
- Excellent Handling
- Tolerated in Clean & Contaminated Wounds

Tensile Strength

- 70% at 14 days
- 50% at 21 days
- 25% at 28 days
- Complete Absorption at 60 to 85 days

CHROMIC GUT (Chromic Treated Natural Gut)

Advantages

- Treated Chromic Salt • Predictable Strength
- Smooth Surface For Knot Run Down & Strength

Tensile Strength

- 21-28 days
- Absorption Process Varies

Absorption Chart

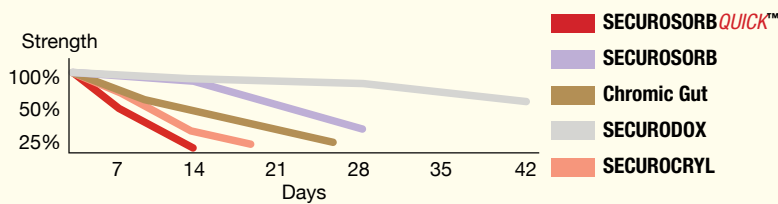

Ductile Strength

40% Increase in ductility. When needle bends it is less likely to break when reshaping.

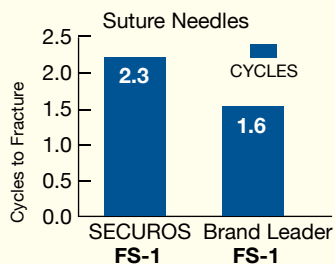

Sharper Needle

20% Increase in penetration. Less force, less trauma.

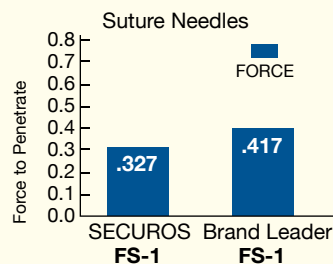

Absorbable Sutures

Premium Sutures

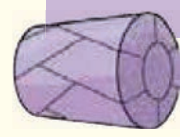

SECUROSORB™ SECUROSORB QUICK™
Coated Braided Violet Polyglactin 910 Synthetic Absorbable Suture Fast Absorbing

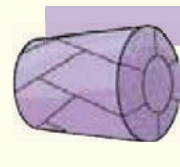

SECUROSORB PLUS™
Coated Braided Violet *antibacterial* Polyglactin 910 Synthetic Absorbable Suture



CHROMIC GUT
Chromic Treated Natural Absorbable Suture

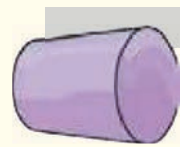

SECURODOX™
Violet Monofilament Polydioxanone Synthetic Absorbable Suture

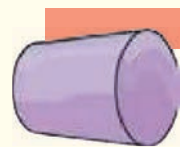

SECUROCRYL™
Violet Monofilament POLY(glycolide-co-caprolactone) Synthetic Absorbable Suture

Nonabsorbable Sutures

Premium Sutures

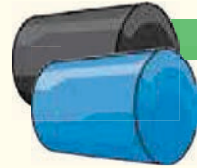

SECUROLON™
Blue or Black Nylon Monofilament Synthetic Non-Absorbable Suture

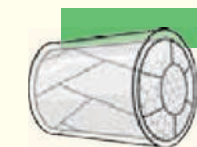

SECUROMID™
Cabled Braided Nylon Synthetic Non-Absorbable Suture

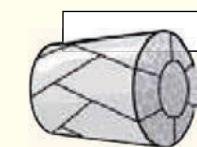

ORTHO FIBER™
Itra High Molecular Weight Polyethylene Synthetic Non-Absorbable Suture



SECUROPRO™
Blue Monofilament Polypropylene Synthetic Non-Absorbable Suture



VISIPRO™
Pink Monofilament Fluorescent Polypropylene Synthetic Non-Absorbable Suture

SECUROS Surgical



SECUROTRAC™ Design

Less Memory
Easy Handling
Stronger Suture



Single Unit Pouch

Easy Open Design



Dozen Box Packaging

30" Suture Lengths

More value per unit

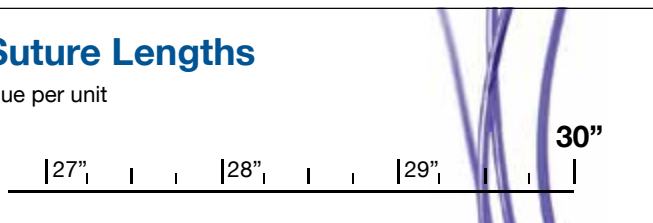

MADE IN THE USA

Hand attached needles with 100% in line needle pull tested.





Swaged-on Suture Products

Premium SECUROTRAC™ design delivers low suture memory

SECURODOX™ Violet Monofilament PDO					
ITEM CODE	NEEDLE	SIZE		LENGTH	
		USP	EP	USA	EURO
D195	CP	2	5	30"	75cm
D304	RB-1	4-0	1.5	30"	75cm
D305	RB-1	3-0	2	30"	75cm
D310	SH-1	4-0	1.5	30"	75cm
D311	SH-1	3-0	2	30"	75cm
D315	SH	4-0	1.5	30"	75cm
D316	SH	3-0	2	30"	75cm
D317	SH	2-0	3	30"	75cm
D332	CT-2	3-0	2	30"	75cm
D333	CT-2	2-0	3	30"	75cm
D334	CT-2	0	3.5	30"	75cm
D338	CT-1	3-0	2	30"	75cm
D339	CT-1	2-0	3	30"	75cm
D340	CT-1	0	3.5	30"	75cm
D341	CT-1	1	4	30"	75cm
D397	FS-2	4-0	1.5	30"	75cm
D398	FS-2	3-0	2	30"	75cm
D451	FS-1	2-0	3	30"	75cm
D452	FS-1	3-0	2	30"	75cm
D463	P3	5-0	1	18"	45cm
D466	CP-1	2-0	3	30"	75cm
D467	CP-1	0	3.5	30"	75cm
D468	CP-1	1	4	30"	75cm
D968	CP-2	3-0	2	30"	75cm
D969	CP-2	2-0	3	30"	75cm
D970	CP-2	0	3.5	30"	75cm

SECUROCRYL™ Violet Monofilament PGCL					
ITEM CODE	NEEDLE	SIZE		LENGTH	
		USP	EP	USA	EURO
Q315	SH	4-0	1.5	30"	75cm
Q316	SH	3-0	2	30"	75cm
Q317	SH	2-0	3	30"	75cm
Q344	CT-1	3-0	2	36"	90cm
Q345	CT-1	2-0	3	36"	90cm
Q346	CT-1	0	3.5	36"	90cm
Q347	CT-1	1	4	36"	90cm
Q463	P-3	5-0	1	18"	45cm
Q464	P-3	4-0	1.5	18"	45cm
Q732	SH	2-0	3	36"	45cm
Q762	CT-2	2-0	3	36"	90cm
Q922	FS-2	4-0	1.5	36"	90cm
Q923	FS-2	3-0	2	36"	90cm
Q942	FS-1	3-0	2	36"	90cm
Q943	FS-1	2-0	3	36"	90cm
Q967	CP1	0	3.5	36"	90cm
Q987	FSL	0	3.5	36"	90cm

SECUROSORB™ Coated Braided PGLA					
(for Antibacterial sutures, please contact SECUROS)					
ITEM CODE	NEEDLE	SIZE		LENGTH	
		USP	EP	USA	EURO
V195	CP	2	5	30"	75cm
V310	SH-1	4-0	1.5	30"	75cm
V311	SH-1	3-0	2	30"	75cm
V316	SH	3-0	2	30"	75cm
V317	SH	2-0	3	30"	75cm
V327	CT-3	3-0	2	30"	75cm
V332	CT-2	3-0	2	30"	75cm
V333	CT-2	2-0	3	30"	75cm
V334	CT-2	0	3.5	30"	75cm
V338	CT-1	3-0	2	30"	75cm
V339	CT-1	2-0	3	30"	75cm
V340	CT-1	0	3.5	30"	75cm
V341	CT-1	1	4	30"	75cm
V345	CT-1	2-0	3	36"	90cm
V397	FS-2	4-0	1.5	30"	75cm
V398	FS-2	3-0	2	30"	75cm
V451	FS-1	4-0	1.5	30"	75cm
V452	FS-1	3-0	2	30"	75cm
V453	FS-1	2-0	3	30"	75cm
V460	X-1	3-0	2	30"	75cm
V461	X-1	2-0	3	30"	75cm
V466	CP-1	2-0	3	30"	75cm
V467	CP-1	0	3.5	30"	75cm
V468	CP-1	1	4	30"	75cm
V586	FSL	2-0	3	30"	75cm
V587	FSL	0	3.5	30"	75cm
V808	CCS-1	3	6	30"	75cm
V880	TP-1	2	5	54"	135mm

SECUROPRO™ Blue Monofilament Polypropylene					
ITEM CODE	NEEDLE	SIZE		LENGTH	
		USP	EP	USA	EURO
P8411	CT-2	2-0	3	30"	75cm
P8424	CT-1	0	3.5	30"	75cm
P8444	V-34	0	3.5	30"	75cm
P8665	FS-2	3-0	2	18"	45cm
P8683	FS-2	4-0	1.5	18"	45cm
P8684	FS-1	3-0	3	18"	45cm
P8685	FS	2-0	3.5	18"	45cm
P8690	FSLX	0	2	30"	75cm
P8825	TP-1	2	5	60"	150cm
P8832	SH	3-0	3	30"	75cm
P8872	RB-1	3-0	3	30"	75cm

Cross reference available on request.

Manufacturer Shelf Life (before opening) Swaged-on Sutures: SECUROCRYL – 2 years. All other Swaged-on Sutures – 3 years.

Ophthalmic Codes

SECUROPRO™ 
Blue Monofilament Polypropylene

ITEM CODE	NEEDLE	SIZE		LENGTH	
		USP	EP	USA	EURO
P8661	FS-2	5-0	1	18"	45cm
P8665	FS-2	3-0	2	18"	45cm
P8683	FS-2	4-0	1.5	18"	45cm
P8697	P-1	6-0	0.7	18"	45cm
P8698	P-3	5-0	1	18"	45cm

SILK™ 
Black Braided Silk (available upon request)

ITEM CODE	NEEDLE	SIZE		LENGTH	
		USP	EP	USA	EURO
S639	P-1	6-0	0.7	18"	45cm
S640	P-3	5-0	1	18"	45cm
S683	FS-2	4-0	1.5	18"	45cm
S684	FS-1	3-0	2	18"	45cm

SECUROSORB™ 
Coated Braided PGLA & PGA

ITEM CODE	COLOR	NEEDLE	SIZE		LENGTH	
			USP	EP	USA	EURO
V449	Violet	2x CS160-8	9-0	0.3	12"	30cm
V463	Violet	P-3	5-0	1	18"	45cm
V488	Undyed	P-1	7-0	0.5	18"	45cm
V489	Undyed	P-1	6-0	0.7	18"	45cm
V490	Undyed	P-1	5-0	1	18"	45cm
V493	Undyed	P-3	5-0	1	18"	45cm
V546	Violet	2x TG140-8	7-0	0.5	18"	45cm
V548	Violet	2x TG140-8	8-0	0.4	12"	30cm
V555	Violet	2x S-29	6-0	0.7	18"	30cm

Specialty Products

OrthoFiber™ 
High Strength Ultra High Molecular Weight Polyethylene

ITEM CODE	COLOR	NEEDLE	SIZE		LENGTH	
			USP	EP	USA	EURO
000370	White	Sm Cruciate/Straight	5	7	36"	90cm
000371	White	Med Cruciate/Straight	5	7	36"	90cm
001104	White	None	5	7	36"	90cm
004767	Blue & White	2 - Straight	2	5	36"	90cm

SECUROLON™ 
BLUE Monofilament Nylon

ITEM CODE	NEEDLE	SIZE		LENGTH	
		USP	EP	USA	EURO
460BL	LR	2-0	3	20"	50cm
628BL	KS	2-0	3	30"	75cm
662BL	FS-2	4-0	1.5	30"	75cm
663BL	FS-1	3-0	2	30"	75cm
664BL	FS	2-0	3	30"	75cm
665BL	FSL	0	3.5	30"	75cm
1674BL	FSLX	2-0	3	30"	75cm

SECUROLON™ 
BLACK Monofilament Nylon

ITEM CODE	NEEDLE	SIZE		LENGTH	
		USP	EP	USA	EURO
661BK	FS-2	5-0	1	18"	45cm
662BK	FS-2	4-0	1.5	18"	45cm
663BK	FS-1	3-0	2	18"	45cm
664BK	FS	2-0	3	18"	45cm

CHROMIC GUT™ 
Chromic Treated Natural Gut

ITEM CODE	NEEDLE	SIZE		LENGTH	
		USP	EP	USA	EURO
CG117	Non-needled	3	7	54"	135cm
CG122	SH	3-0	3	30"	75cm
CG123	SH	2-0	3.5	30"	75cm
CG181	SH-1	4-0	2	30"	75cm
CG635	FS-2	4-0	2	30"	75cm
CG636	FS-2	3-0	3	30"	75cm
CG637	FS-1	2-0	3.5	30"	75cm
CG812	CT-1	0	4	30"	75cm
CG813	CT-1	1	5	30"	75cm
CG882	CT-2	3-0	3	30"	75cm
CG883	CT-2	2-0	3.5	30"	75cm
CG884	CT-2	0	4	30"	75cm

VISIPRO™ 
Pink Monofilament Fluorescent Polypropylene

ITEM CODE	NEEDLE	SIZE		LENGTH	
		USP	EP	USA	EURO
F8665	FS-2	3-0	2	30"	75cm
F8683	FS-2	4-0	1.5	30"	75cm
F8684	FS-1	3-0	2	30"	75cm
F8685	FS	2-0	3	30"	75cm
F8689	FSLX	2-0	3	30"	75cm
F8690	FSLX	0	3.5	30"	75cm

Manufacturer Shelf Life (before opening) Swaged-on Sutures: SECUROCRYL – 2 years. All other Swaged-on Sutures – 3 years.

Cassettes



VISIPRO™
Pink Monofilament Fluorescent Polypropylene (Non-Absorbable)

ITEM CODE	SIZE	LENGTH
MCF-0	0	85m
MCF-2/0	2-0	110m
MCF-3/0	3-0	110m
MCF-4/0	4-0	110m



SECUIROSORB/ SECUIROSORB PLUS™
Coated Braided Violet Polyglactin 910 (Absorbable)

ITEM CODE	PLUS ITEM CODE	SIZE	LENGTH
MCV-3		3	25m
MCV-2	MCVP-2	2	25m
MCV-1	MCVP-1	1	25m
MCV-0	MCVP-0	0	25m
MCV-2/0	MCVP-2/0	2-0	25m
MCV-3/0	MCVP-3/0	3-0	25m
MCV-4/0	MCVP-4/0	4-0	25m



SECUIROCRYL™
Violet Monofilament Poliglecaprone 25 (Absorbable)

ITEM CODE	SIZE	LENGTH
MCQ-1	1	25m
MCQ-2	2	25m
MCQ-0	0	25m
MCQ-2/0	2-0	25m
MCQ-3/0	3-0	25m
MCQ-4/0	4-0	25m



SECUIROMID™
Braided Cabled Nylon (Non-Absorbable)

ITEM CODE	SIZE	LENGTH
MCS-4	4	25m
MCS-3	3	50m
MCS-2	2	50m
MCS-1	1	75m
MCS-0	0	75m
MCS-2/0	2-0	100m
MCS-3/0	3-0	100m
MCS-4/0	4-0	100m



SECUIRODOX™
Violet Monofilament Polydioxanone (Absorbable)

ITEM CODE	SIZE	LENGTH
MCD-2	2	25m
MCD-1	1	25m
MCD-0	0	25m
MCD-2/0	2-0	25m
MCD-3/0	3-0	25m
MCD-4/0	4-0	25m



CHROMIC GUT
Chromic Treated Natural Gut (Absorbable)

ITEM CODE	SIZE	LENGTH
MCG-4	4	25m
MCG-3	3	40m
MCG-2	2	45m
MCG-1	1	50m
MCG-0	0	50m
MCG-2/0	2-0	50m
MCG-3/0	3-0	50m
MCG-4/0	4-0	50m



CASSETTE RACK
Holds 5 Cassettes

ITEM CODE
MCR-100

Manufacturer Shelf Life (before opening) Cassettes:
SECUIRODOX, SECUIROCRYL, SECUIROSORB/SECUIROSORB PLUS – 2 years | Chromic Gut, SECUIROMID, VISIPRO – 5 years

Suture Micro Cassette

Eco-Friendly

50% Less Plastic

Aseptic

Flip Top

Convenient

Pocket Size

Efficient

Built-In Cutter

Consistent Spin

Brakeless Design

Less Memory

New Reel Design

Stronger Suture

Exceeds USP



(actual size)



Stainless Steel CASSETTE RACK

“for all your suture needs”

MADE IN USA
patent pending

SURGICAL Needles



Surgical Needle 3/8 Circle Reverse Cutting Edge, Sleeve of 12



Needle Tip Shape

MWI#	SECUROS#	DESCRIPTION
034338	003332	Surgical Needle 3/8 Circle #1
034335	003395	Surgical Needle 3/8 Circle #2
034341	003330	Surgical Needle 3/8 Circle #4
034331	003328	Surgical Needle 3/8 Circle #6
034324	003326	Surgical Needle 3/8 Circle #8
034547	003325	Surgical Needle 3/8 Circle #9
034320	003324	Surgical Needle 3/8 Circle #10
034333	003323	Surgical Needle 3/8 Circle #11
034318	003322	Surgical Needle 3/8 Circle #12
034327	003321	Surgical Needle 3/8 Circle #13
034317	003320	Surgical Needle 3/8 Circle #14
034322	003319	Surgical Needle 3/8 Circle #15
034307	003318	Surgical Needle 3/8 Circle #16
034329	003317	Surgical Needle 3/8 Circle #17
034319	003316	Surgical Needle 3/8 Circle #18
034334	003315	Surgical Needle 3/8 Circle #19
034321	003314	Surgical Needle 3/8 Circle #20

Surgical Needle 3/8 Circle Taper Point, Sleeve of 12



Needle Tip Shape

MWI#	SECUROS#	DESCRIPTION
034554	003385	Surgical Needle 3/8 Circle #1
034553	003384	Surgical Needle 3/8 Circle #2
034552	003370	Surgical Needle 3/8 Circle #10
034551	003379	Surgical Needle 3/8 Circle #12
034550	003378	Surgical Needle 3/8 Circle #14
034548	003376	Surgical Needle 3/8 Circle #16
034549	003374	Surgical Needle 3/8 Circle #18
034558	003372	Surgical Needle 3/8 Circle #20

Surgical Needle 1/2 Circle Cutting Edge, Sleeve of 12

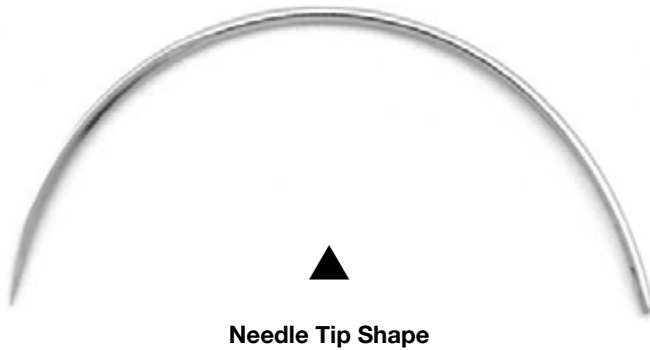

MWI#	SECUROS#	DESCRIPTION
034346	003368	Surgical Needle 1/2 Circle #1
034340	003366	Surgical Needle 1/2 Circle #6
034342	003357	Surgical Needle 1/2 Circle #8
034330	003356	Surgical Needle 1/2 Circle #10
034343	003396	Surgical Needle 1/2 Circle #11
034326	003355	Surgical Needle 1/2 Circle #12
034336	003364	Surgical Needle 1/2 Circle #13
034323	003363	Surgical Needle 1/2 Circle #14
034332	003362	Surgical Needle 1/2 Circle #15
034325	003359	Surgical Needle 1/2 Circle #16
034339	003361	Surgical Needle 1/2 Circle #17
034328	003353	Surgical Needle 1/2 Circle #18
034345	003352	Surgical Needle 1/2 Circle #20

Surgical Needle 1/2 Circle Taper Point, Sleeve of 12

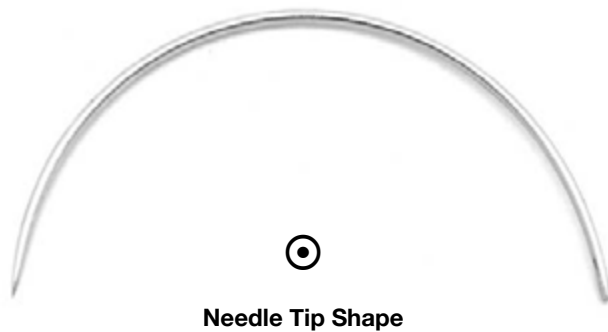

MWI#	SECUROS#	DESCRIPTION
034555	003350	Surgical Needle 1/2 Circle #1
034560	003349	Surgical Needle 1/2 Circle #2
034561	003342	Surgical Needle 1/2 Circle #10
034556	003344	Surgical Needle 1/2 Circle #12
034557	003343	Surgical Needle 1/2 Circle #14
034559	003340	Surgical Needle 1/2 Circle #16

Surgical Needle 1/2 Curved Cutting Edge, Sleeve of 12

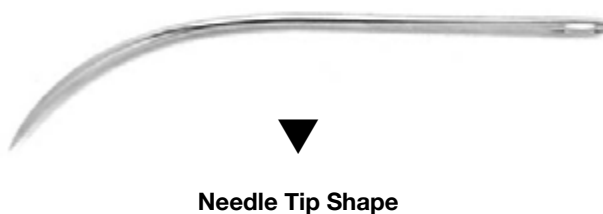

MWI#	SECUROS#	DESCRIPTION
034337	003388	Surgical Needle 1/2 Curved #7
034344	003389	Surgical Needle 1/2 Curved #9
048187	003313	Surgical Needle 1/2 Curved #10

A-Z Product Index

A

Aiming Guide - Universal, Coxofemoral Luxation Management 136

B

Bending Instruments, Conventional Plating236-238

Bending Instruments, Tibial Plateau Leveling Osteotomy102-103

Bone Anchors61-62

Bone Cement 275

Bone Cutting Forceps, Femoral Head Osteotomy 144

Bone Cutting Forceps, Orthopedic Specialty Instruments286-288

Bone Cutting Forceps, Patellar Luxation 128

Bone Holding Forceps, Femoral Head Osteotomy 142

Bone Holding Forceps, Complete Offering280-285

Bone Holding Forceps, Pelvic Osteotomy154-155

Bone Reduction Forceps, Arthrodesis 164

Bone Reduction Forceps, Tibial Tuberosity Advancement 90

Bone Tamps 290

Burs (Disposable) 165

C

Cast Spreaders303

Chisels 279

ColorDot®, Surgical 316

Connecting Rods182-183

Countersinks 240

Crimp Clamps 60

Crimping Device, PowerX 63

Curettes 300

D

Dental, Surgical402-413

Depth Gauges, Arthrodesis 167

Depth Gauges, Conventional Plating 243

Depth Gauges, PAX Locked Plating 262

Depth Gauges, Pelvic Osteotomy 151

Depth Gauges, Tibial Plateau Leveling Osteotomy 105

Depth Gauges, Tibial Tuberosity Advancement 88

Drill Bits, Arthrodesis 166

Drill Bits, Conventional Plating 239

Drill Bits, Coxofemoral Luxation Management 138

Drill Bits, External Skeletal Fixation 177

Drill Bits, Extracapsular Stabilization 64

Drill Bits, PAX Locked Plating 261

Drill Bits, Pelvic Osteotomy 150

Drill Bits, Tibial Plateau Leveling Osteotomy 104

Drill Bits, Tibial Tuberosity Advancement 87

Drill Guides & Sleeves, Conventional Plating241-242

Drill Guides, Arthrodesis 167

Drill Guides, PAX Locked Plating 262

Drill Guides, Pelvic Osteotomy150-151

Drill Guides, Tibial Plateau Leveling Osteotomy 104

Drill Guides, Tibial Tuberosity Advancement 87

Drill Sleeves, External Skeletal Fixation 176

Drills, Battery Powered 65

Dynamization Bolts 181

E

Elevators279-280

External Skeletal Fixation Augmentation Clamps 180

External Skeletal Fixation Augmentation Plates 180

External Skeletal Fixation Clamps178-179

External Skeletal Fixation Pin Placement Devices 176

External Skeletal Fixation Positive Profile Pins174-175

F

Fastfix 183

Forceps, Meniscal Management122-123

Forceps, Surgical340-347

G

Gigli Saws 301

H

Hand Chuck Keys & Extension Handle302

Hand Chucks 64,129,192,302

Hatt Spoon 136,141

Hemostats, Surgical348-359

I

Instrument Care308-321

Instrument Packs, Surgical414-416

Instrument, Cleaners320-321

Instrument, Cleaning & Sterilization 310

Instrument, ColorDot® 316

Instrument, Detailed Inspection317-319

Instrument, Repair314-315

Instrument, Troubleshooting311-313

Instrument, Warranty 308

Instruments, Arthrodesis 163

Instruments, Conventional Plating System 235

Instruments, Coxofemoral Luxation Management 136

Instruments, External Skeletal Fixation 176

Instruments, Extracapsular Stabilization 63

Instruments, Femoral Head Osteotomy 141

Instruments, Meniscal Management 119

Instruments, PAX Locked Plating 261

Instruments, Standard TTA Plates.....	91
Instruments, Tibial Tuberosity Advancement	86

K

Kits, Conventional Plate Osteosynthesis - 2.4mm	36-37
Kits, Conventional Plate Osteosynthesis - 4.5mm	42-43
Kits, Conventional Plate Osteosynthesis - 5.5mm	44-45
Kits, Conventional Plate Osteosynthesis - Mini Fragment	32-35
Kits, Conventional Plate Osteosynthesis - Small Fragment	38-41
Kits, Coxofemoral Luxation Management.....	22-23
Kits, Extracapsular Stabilization	9-10
Kits, Femoral Head Osteotomy	24
Kits, IM Pin Starter.....	200
Kits, Linear External Skeletal Fixation	26-29
Kits, Locked Plate Osteosynthesis - Mini Fragment	46-47
Kits, Locked Plate Osteosynthesis - Small Fragment	48-49
Kits, Meniscal Management.....	20
Kits, Patellar Management Luxation	21
Kits, Pin & Wire Management	30-31
Kits, Tibial Plateau Leveling Osteotomy	16-19
Kits, Tibial Tuberosity Advancement	10-15
Kirschner Wires, Patellar Luxation.....	125
Kirschner Wires, Pin & Wire Management.....	189

M

Mallets, Tibial Tuberosity Advancement.....	91
Mallets, Femoral Head Osteotomy.....	143
Mallets, Complete Offering.....	289
Mallets, Patellar Luxation	127
Mallets, Tibial Plateau Leveling Osteotomy	110
Michele Trephines.....	301
Micro Beaver Blade Handle & Blades.....	119
Miscellaneous, Surgical	384-393
Monofilament Nylon Puller	136
Monofilament Nylon Suture & Crimp Clamp Packs	60

N

Needle Holder, Cruciate.....	63,371
Needle Holders, Surgical	364-371
Needles, Cruciate	59
Needles, Suture	428-429
Nut Drivers, External Skeletal Fixation	181

O

Ophthalmic, Surgical	394-401
Organizer Bags, Coxofemoral Luxation Management	139
Organizer Bags, Extracapsular Stabilization	66
Organizer Bags, Pin & Wire Management	201
Osteotomes , Complete Offering	278
Osteotomes, Femoral Head Osteotomy.....	143
Osteotomes, Patellar Luxation	126

Osteotomes, Tibial Plateau Leveling Osteotomy	110
-----------------------------------------------------	-----

P

Patella Forceps.....	286
Patellar Luxation Spacers	85
Patellar Luxation Saw & Accessories	126
Pin Punches	200
Pins, Steinmann/Intramedullary, Extracapsular Stabilization	64
Pins, Steinmann/Intramedullary, Patellar Luxation	125
Pins, Steinmann/Intramedullary, Pin & Wire Management.....	190
Pin/Wire Cutters, Patellar Luxation.....	130-131
Pin/Wire Cutters, Complete Offering.....	197-199
Pin/Wire Cutters, Tibial Plateau Leveling Osteotomy	109
Plate Forceps	163,235
Plate Stringers	251
Plates, Acetabular, Conventional Plating	220
Plates, Arthrodesis (Pancarpal)	158
Plates, Arthrodesis (Pantarsal)	159
Plates, Butterfly, PAX Locking Plating.....	258
Plates, Distal Femur Osteotomy, Conventional Plating	221
Plates, Double Pelvic Osteotomy	148
Plates, L-Plates, Conventional Plating.....	219
Plates, Specialty, Conventional Plating.....	216-221
Plates, Specialty, PAX Locking	258
Plates, Straight, Conventional Plating.....	203-215
Plates, Straight, PAX Locking.....	254-257
Plates, T-Plates, Conventional Plating	216-218
Plates, T-Plates, PAX Locking Plating.....	258
Plates, Triple Pelvic Osteotomy	147
Pneumatic Saws & Accessories, Tibial Plateau Leveling Osteotomy	112-113
Probes & Hooks	122

R

Rasps, Femoral Head Osteotomy.....	144
Rasps, Complete Offering.....	291
Rasps, Patellar Luxation	127
Rasps, Reciprocating	165
Reference Materials, Conventional Plating	251
Reference Materials, Coxofemoral Luxation Management.....	139
Reference Materials, External Skeletal Fixation	185
Reference Materials, Extracapsular Stabilization	67
Reference Materials, PAX Locked Plating.....	269
Reference Materials, Pin & Wire.....	201
Reference Materials, Tibial Plateau Leveling Osteotomy.....	117
Reference Materials, Tibial Tuberosity Advancement.....	93
Retractors, Arthrodesis.....	164
Retractors, Coxofemoral Luxation Management	137
Retractors, Femoral Head Osteotomy.....	141
Retractors, Meniscal Management	119-121
Retractors, Pelvic Osteotomy	153
Retractors, Surgical	372-383

Rongeurs, Femoral Head Osteotomy.....	145
Rongeurs, Meniscal Management.....	123
Rongeurs, Complete Offering	292-300
Rongeurs, Patellar Luxation	128

S

Saw Blades, Oscillating (Disposable).....	305
Saw Blades, Tibial Plateau Leveling Osteotomy	114-115
Scalpel Blades, Surgical	324-325
Scalpel Handles, Surgical	323
Scissors, Surgical	326-339
Screw Extraction Instruments	246
Screw Forceps	163,235
Screwdriver Handles, Arthrodesis	168
Screwdriver Handles, Conventional Plating	244-245
Screwdriver Handles, PAX Locked Plating	263
Screwdriver Handles, Pelvic Osteotomy.....	152
Screwdriver Handles, Tibial Plateau Leveling Osteotomy	106-107
Screwdriver Handles, Tibial Tuberosity Advancement	89
Screwdriver Holding Sleeves, Arthrodesis.....	168
Screwdriver Holding Sleeves, Conventional Plating.....	245
Screwdriver Holding Sleeves, Pelvic Osteotomy	152
Screwdriver Holding Sleeves, Tibial Plateau Leveling Osteotomy	107
Screwdriver Holding Sleeves, Tibial Tuberosity Advancement	89
Screwdriver Shafts, Arthrodesis.....	167
Screwdriver Shafts, Conventional Plating.....	244
Screwdriver Shafts, PAX Locked Plating.....	263
Screwdriver Shafts, Pelvic Osteotomy	152
Screwdriver Shafts, Tibial Plateau Leveling Osteotomy	106
Screwdriver Shafts, Tibial Tuberosity Advancement	88
Screwdrivers, Arthrodesis.....	167
Screwdrivers, Conventional Plating.....	243
Screwdrivers, Pelvic Osteotomy	151
Screwdrivers, Tibial Plateau Leveling Osteotomy	105
Screwdrivers, Tibial Tuberosity Advancement	88
Screws, Arthrodesis.....	160-162
Screws, Conventional Plating	223
Screws, Pelvic Osteotomy	149
Screws, PAX Locking.....	259-260
Screws, Tibial Plateau Leveling Osteotomy	98-101
Screws, Triple Pelvic Osteotomy	149-150
Screws, Tibial Tuberosity Advancement.....	81-84
Silicone Mat.....	304
Smillie Cartilage Knives.....	280
Sterilization Trays, Arthrodesis	169
Sterilization Trays, Conventional Plating	248, 250
Sterilization Trays, Coxofemoral Luxation Management.....	139
Sterilization Trays, External Skeletal Fixation	185
Sterilization Trays, Extracapsular Stabilization	65
Sterilization Trays, Meniscal Management.....	123
Sterilization Trays, Orthopedic Specialty.....	303-304

Sterilization Trays, Patellar Luxation	131
Sterilization Trays, PAX Locked Plating.....	264-268
Sterilization Trays, Pelvic Osteotomy.....	155
Sterilization Trays, Surgical.....	417
Sterilization Trays, Tibial Plateau Leveling Osteotomy.....	116
Sterilization Trays, Tibial Tuberosity Advancement.....	92
Suture, Cassettes - Surgical Suture	425
Suture, Swaged-on Monofilament Nylon	56-57
Suture, Swaged-on OrthoFiber.....	58, 135
Suture, Swaged-on Surgical Suture.....	423-424
Suture, Spools - Monofilament Nylon.....	59, 135

T

Taps , Conventional Plating.....	240
Taps, Tibial Plateau Leveling Osteotomy	107
Tensioning Device, Universal.....	63
Toggle Rod Insertion Device	136
Toggle Rods	135
Towel Clamps, Surgical	360-363
Tibial Plateau Leveling Osteotomy JIG & Pins	108
Tibial Plateau Leveling Osteotomy Plates.....	96
Tibial Tuberosity Advancement Cage Cutter.....	74, 90
Tibial Tuberosity Advancement Cages	70-74
Tibial Tuberosity Advancement Fork Drill Guide.....	91
Tibial Tuberosity Advancement Fork Inserter	91
Tibial Tuberosity Advancement Forks.....	80
Tibial Tuberosity Advancement Plate Bender	86
Tibial Tuberosity Advancement Plates.....	75-79
Tibial Tuberosity Advancement Posts	91
Tibial Tuberosity Advancement T-Handle.....	86
Tibial Tuberosity Advancement T-Handle Spacers.....	86

V

Velocity Bone Graft	85,163,273
---------------------------	------------

W

Washers	234
Wire Benders.....	130,197
Wire, Orthopedic with Loop (Cerclage)	191
Wire, Orthopedic, Patellar Luxation.....	125
Wire, Orthopedic, Pin & Wire Management.....	191
Wire Passers	192
Wire Twisters	193-196
Wrenches	181



SECUROS USA
Tel: (877) BONEFIX (266-3349)
Email: info@securos.com
www.securos.com

SECUROS Europe GmbH
Take Off Gewerbepark 4
78579 Neuhausen Ob Eck Germany
Tel.: +49 7467 9476 50
Fax: +49 7467 9476 52
Email: info@securos-europe.eu
www.securos-europe.eu

SECUROS UK
Centaur House
Torbay Road
Castle Cary
BA7 7EU
Tel: +0845 070 2498
Fax: +0845 070 2499
Email: sales@securos.co.uk
www.securos.co.uk