



*Empowering Veterinarians to deliver the
highest standards of patient care*

2025 Product Catalogue





Veterinary
Instrumentation

General Orthopaedics

Joint Surgery

Internal Fixation

External Fixation

Surgical Power Tools

Spinal Surgery

General Surgical

Soft Tissue

Ophthalmic

Dental

General Clinical

Patient Warming and Monitoring

Rehabilitation

Plate Profiles

Index

Veterinary Instrumentation Partnership Programme

Generate Measurable Rewards To Innovate Your Practice



Vi are continuously looking at ways to innovate and evolve our service delivery.

Through discussions with a number of veterinary professionals, many wanted to be part of a loyalty scheme but their providers did not facilitate one. Our solution? The introduction of the Vi Partnership Programme (ViPP).

Practices, through a partnership approach, are rewarded for every investment made in Vi branded products and services, with bespoke benefits delivered throughout the programme.

What are the benefits to joining the Veterinary Instrumentation Partnership Programme?



Additional discounts across the entire Vi branded range



Annual **credit rebates**



Business support meetings with your dedicated Territory Account Manager to assist in making your practice as profitable as possible



Free **exhibition & conference** passes



Access to **training resources**, including access to our **E-Learning** platform & **Surgery Guides**

What Next?

To discuss how the Veterinary Instrumentation Partnership Programme could benefit you and your Practice, please [email info@vetinst.com](mailto:info@vetinst.com)



Training & Education Support Programmes

E-Learning Platform



The Vi e-learning platform delivers a variety of veterinary educational material in an engaging and interactive format.

Whether you are a Veterinary Surgeon, a Veterinary Nurse, a Student VN or an Animal Care Auxiliary, you should find modules and content that are clinically relevant to you. With CPD certificates available, our e-learning content can help you to fulfil your annual CPD requirements, at the click of a button and from the comfort and convenience of your home or workplace. The e-learning platform also allows access to recordings of all Vi webinars, and new content is added periodically, so make sure you log in regularly to see what's new!



Scan to register for e-learning today!



Practical Courses



Continuing Professional Development is one of our core company values. Vi supported the delivery of 155 courses in 2024, both within the UK and Internationally, investing over £60,000 per annum to ensure the facilitation of successful training courses and development of Veterinary healthcare professionals.



Scan to see our CPD course calendar!

Webinars



Since 2021, Vi have been delivering bimonthly KOL-led webinars. These live, interactive, free-to-attend sessions continue to soar in popularity with our audience, old and new! In 2024, we welcomed more than 1800 live attendees! An attendance certificate is provided to all live attendees, so these clinically relevant and engaging sessions are the ideal way to help fulfil your annual CPD requirements.



Scan to register for webinar updates!

General Orthopaedics



To visit the General Orthopaedics section of our website, please scan the QR code.



Vi Orthopaedic Starter Kit - Standard



The Standard Kit Contains:

001000	Adjustable Bone Saw With 5 Blades	x1	090003	Bone Pin Trochar 7/64 2.8mm Diam 300mm Long	x1
001004	Orthopaedic Stainless Steel Hard Back Saw 0.4mm Cut	x1	090004	Bone Pin Trochar 1/8 3.2mm Diam 300mm Long	x1
001010	Excision Arthroplasty Rasp	x1	090005	Bone Pin Trochar 9/64 3.50mm Diam 300mm Long	x1
001048	Mini Hohman Retractor 8mm Short Tip	x1	090006	Bone Pin Trochar 5/32 4.0mm Diam 300mm Long	x1
001090	Disarticulator Small	x1	090007	Bone Pin Trochar 3/16" 4.8mm Diam 300mm Long	x1
001116	Meniscus Surgery Set	x1	090008	Bone Pin Trochar 1/4 6.35mm Diam 300mm Long	x1
001221	Standard Jacobs Chuck & Handle 1/4" 6mm Capacity	x1	090021ART	1.1mm Arthrodesis Wire 125mm Long Pack of 10	x1
001234	Implant Cutter S/Steel Cuts To 4.0mm 370mm Long TC Inserts	x1	090024ART	1.4mm Arthrodesis Wire 125mm Long Pack of 10	x1
001237/I	Implant Cutter S/Steel Simple Action 2.0mm Max 255mm Long	x1	090022ART	1.6mm Arthrodesis Wire 125mm Long Pack of 10	x1
001250	Wire Passer Double Ended 145mm	x1	090023ART	2.0mm Arthrodesis Wire 125mm Long Pack of 10	x1
001260	Wire Twister & Shear Cutter 165mm	x1	090038	Bone Pin Roll	x1
001271	Periosteal Elevator CVD AO Type 180mm 6mm End PTFE Handle	x1	090039E	K/A Wire Storage Tube & Dispenser 125mm 0.9/1.1/1.6/2.0	x1
001300	Small Curved Rongeurs 4mm Bite	x1	091151	CCL Kit - Crimpers H/Duty Needleholders & 2 of Each Nylon	x1
001310	Small Angled Cutter 15mm Blade	x1	623850	15mm Osteotome Swedish Pattern 205mm	x1
001320	Mallet 300g	x1	782600	Volkman Scoop Double Ended 4mm & 6mm 200mm Long	x1
001362	Kirschner & Arthrodesis Wire Bender 140mm	x1	H090104	2.7mm Round Shank Drill Hard	x1
001600	Variable Speed Orthopaedic Drill Kit	x1	H090106S	3.5mm Round Shank Drill Hard	x1
090000	Bone Pin Trochar 1/16 1.6mm Diam 300mm Long	x1	OW0810	Reel of Orthopaedic Wire 0.8mm/21g Diameter	x1
090001	Bone Pin Trochar 5/64 2.0mm Diam 300mm Long	x1	OW1010	Reel of Orthopaedic Wire 1.0mm/20g Diameter	x1
090002	Bone Pin Trochar 3/32 2.4mm Diam 300mm Long	x1	XRAYMARK1	Left And Right Hand X-Ray Markers	x1

ORTHOKITI Vi Orthopaedic Starter Kit

ORTHOKITINP Vi Orthopaedic Starter Kit Standard - No Power Tools
Contains list above but does not include power tools.

Vi Orthopaedic Starter Kit - Enhanced



The Enhanced Kit Contains:

001000	Adjustable Bone Saw With 5 Blades	x1	090022ART	1.6mm Arthrodesis Wire 125mm Long Pack of 10	x1
001004	Orthopaedic Stainless Steel Hard Back Saw 0.4mm Cut	x1	090023ART	2.0mm Arthrodesis Wire 125mm Long Pack of 10	x1
001010	Excision Arthroplasty Rasp	x1	090039E	K/A Wire Storage Tube & Dispenser 125mm 0.9/1.1/1.6/2.0mm	x1
001021	Universal Sulcoplasty Rasp 210mm Long	x1	623850	15mm Osteotome Swedish Pattern 205mm	x1
001041	Hohman Retractor 18mm Short Narrow Tip	x2	782600	Volkman Scoop Double Ended 4mm & 6mm 200mm Long	x1
001042	Hohman Retractor 12mm Short Narrow Tip	x2	AR-17-02	Stifle Lever PTFE Handle 280mm VSTL	x1
00109SET	Hatt Spoon Set Set Of 3	x1	H090102	2.0mm Round Shank Drill Hard	x1
001117	Meniscus Surgery Set - Enhanced	x1	H090104	2.7mm Round Shank Drill Hard	x1
001221	Standard Jacobs Chuck & Handle 1/4" 6mm Capacity	x1	H090106S	3.5mm Round Shank Drill Hard	x1
001234	Implant Cutter S/Steel Cuts To 4.0mm 370mm Long TC Inserts	x1	H090112	2.5mm Round Shank Drill Hard	x1
001237/1	Implant Cutter S/Steel Simple Action 2.0mm Max 255mm Long	x1	HIPTOGKITLF	LigaFiba 3.0mm Tog Introducer 3.5 & 4.5mm Drills & Guide	x1
001250	Wire Passer Double Ended 145mm	x1	IMPBOXTRO	IM Pin Box Complete With Steinman Pins Trochar Tips 30 Total	x1
001260	Wire Twister & Shear Cutter 165mm	x1	LFILSCRSTARTER	LigaFiba Lateral Suture + Crimp Starter Kit	x1
001271	Periosteal Elevator CVD AO Type 180mm 6mm End PTFE Handle	x1	OW0710	Reel of Orthopaedic Wire 0.71mm/ 22g Diameter	x1
001300	Small Curved Rongeurs 4mm Bite	x1	OW0810	Reel of Orthopaedic Wire 0.8mm/ 21g Diameter	x1
001310	Small Angled Cutter 15mm Blade	x1	OW0910	Reel of Orthopaedic Wire 0.9mm/ 20.5g Diameter	x1
001311	Large Angled Cutters 19mm Blade 230mm Long	x1	OW1010	Reel of Orthopaedic Wire 1.0mm/ 20g Diameter	x2
001320	Mallet 300g	x1	SAP2.5	Suture Anchor Pin 2.5mm Diameter 1.0mm Hole	x1
001323	TTA Mallet 140g	x1	SAP3	Suture Anchor Pin 3mm Diameter 1.0mm Hole	x1
001343	10mm Osteotome Light 140mm	x1	SAP4	Suture Anchor Pin 4mm Diameter 2.0mm Hole	x1
001362	Kirschner & Arthrodesis Wire Bender 140mm	x1	XRAYMARK1	Left And Right Hand X-Ray Markers	x2
001363	Stubby Punch 50mm	x1	BLACKKIT	Vi Black Series Drill and Saw Set	x1
001380	Modular Osteotome With Seven Blades - 4,6,8,10,12,15 & 20mm	x1	BLACKSW451207B	Vi Black Saw Blade 45mm x 12mm	x1
090021ART	1.1mm Arthrodesis Wire 125mm Long Pack of 10	x1	BLACKSW451607B	Vi Black Saw Blade 45mm x 16mm	x1
090024ART	1.4mm Arthrodesis Wire 125mm Long Pack of 10	x1			

ORTHOKITTWO Vi Orthopaedic Starter Kit Enhanced With Battery Power

ORTHOKITTWO-NP Vi Orthopaedic Starter Kit Enhanced No Power Tools
Contains list above but does not include power tools.

Fragment Forceps

Pointed Reduction Forceps

Ideal for fragment reduction, these forceps gently hold fragments in position whilst permanent fixation is being applied. Particularly useful in the repair of fractures of the distal femur, acetabulum and distal tibia.

The smaller sizes are useful in the repair of the long bones of the miniature dog and cat as well as the smaller bones of the distal limbs in larger patients.



- 001200** Fragment Forceps 160mm Long
- 001201** Small Fragment Forceps 135mm Long
- 001208** Very Small Fragment Forceps 100mm Long
- 001208M** Miniature Fragment Forceps 135mm Long
- 001200SET** Fragment Forceps Set of 4 (as above)

Pointed Reduction Forceps With Spinlock



Useful for delicate reduction of fragments. Initial reduction is performed with the spinlock flipped out, to give maximum control. Once placed, the spinlock is flipped back in and gently tightened.

- 001200SL** Pointed Reduction Forceps With Spinlock 180mm Long
- 001201SL** Small Fragment Forceps With Spinlock 135mm Long
- 001245SL** Large Fragment Forceps With Spinlock 180mm Long

Very Large Fragment Forceps



Use where a wide gape is required or where the instrument needs to be further out of the surgical field. Spinlock version is very useful during CrCl surgery for repositioning the stifle prior to placement of a lateral suture, or holding osteotomies during closing wedge type procedures.

- 001202** Very Large Fragment Forceps 205mm Long
- 001203** Very Large Fragment Forceps With Spinlock 215mm Long

Reduction Forceps With Hard Wire Guide



Standard pattern fragment forceps with an added wire guide, to allow placement of a temporary or permanent wire as close as possible to the point of reduction.

Guide capacity up to 1.6mm

- 001201W** Reduction Forceps With Wire Guide 140mm Long. Gape 10-25mm
- 001200W** Reduction Forceps With Wire Guide 170mm Long. Gape 15-40mm
- 001202W** Reduction Forceps With Wire Guide 200mm Long. Gape 25-65mm

Twin Point Fragment Forceps



Twin point fragment forceps hold securely while allowing placement of implants such as screws at the point of maximum reduction between the points.

Particularly useful for humeral condyle repairs, and repairs in the small bones distal to the carpus and tarsus.

- 001205** Twin Point Fragment Forceps Straight 170mm Long
- 001206** Twin Point Fragment Forceps Curved 165mm Long

Ikuta Bone Clamps



Ikuta slotted clamps are designed to allow the passage of wires or screws at the point of maximum pressure. For bones up to 20mm diameter. The smaller sizes are for wires, the larger for small screws. Consider Twin Point Fragment Forceps above for larger screws, or a 001219 Long Ratchet Schroeder, for more spring.

- 001207A** Straight For Wires To 2.0mm 125mm Long
- 001207B** Curved For Wires To 2.0mm 125mm Long
- 001207C** Straight For Screws & Wires To 3.0mm 125mm Long
- 001207D** Curved For Screws & Wires To 3.0mm 125mm Long
- 001207SET** Ikuta Bone Forceps Set of 4 (As above)

Long Ratchet Schroeder Tenaculum



A larger, springier version of the straight Twin Point Fragment Forceps. Useful for reduction of small fragments prior to drilling and screwing. Longer ratchet than a standard Schroeder increases usefulness.

001219 Long Ratchet Schroeder Tenaculum Str 240mm Long

Large Twin Point Reduction Forceps With Spinlock



Accessing the point of maximum compression to insert a screw is made easier by the use of twin point forceps. This size is useful for most elbows where accuracy of placement is essential, including Spaniels which are most likely to be affected by HIF.

001204 Twin Point Reduction Forceps With Spinlock 215mm Long

Bone Holding Forceps

There is no universal bone holder. Both the dimensions of the bones involved and the degree of force needed to manipulate or clamp the bone vary immensely. Select the most appropriate forcep for the procedure.

Vi Bone Holding Forceps



Useful general purpose bone holder for maintaining reduction during I/M pinning. Can also be used during plating procedures, passing drills and screws through the jaw centre.

001210 Bone Holding Forceps 155mm Long

Reduction Forceps Serrated Jaws



These reduction forceps have serrated jaws and spinlock which provides secure incremental control.

001217 Reduction Forceps Serrated Jaws Spinlock 190mm Long
001217/L Reduction Forceps Serrated Jaws Spinlock 240mm Long

Small Serrated Bone Holding Forceps



Manipulation of the long bones of cats and small dogs is difficult without crushing. The serrated jaws of this forcep are contoured to maximise grip and support. The tips are sharp. They may be used as small fragment forceps.

001218XS X Small Serrated Bone Holding Forceps 3mm Grasp 140mm
001218S X Small Serrated Bone Holding Forceps 5mm Grasp 140mm
001218 Small Serrated Bone Holding Forceps 7mm Grasp 140mm
001218L Large Serrated Bone Holding Forceps Ratchet 12mm Grasp 180mm
001218SET Serrated Bone Holding Forceps Set of 4 (As above)
001218LG Small Serrated Bone Holding Forceps Spinlock 12mm Grasp 180mm

Small Curved Serrated Reduction Forceps



A nice forcep for the manipulation of small bones or small bone fragments.

001996 Small Curved Serrated Reduction Forceps 145mm Long

Dingmans Forceps



Useful for manipulation of bone fragments.

001470 Dingmans Forceps Long Ratchet 215mm Long

Lowman Bone Clamp Veterinary Pattern



Re-worked traditional human clamp, in sizes suitable for cats and small dogs:

- Lightweight
- Requires minimal exposure
- Use to reduce oblique fractures
- Secures plate to fracture prior to screw placement

- 001991 Lowman Bone Clamp Cat Size 63mm Long
- 001993 Lowman Bone Clamp Large 220mm Long

Kern Bone Holding Forceps



Kerns give a very firm controllable grip, aiding manipulation and reduction of fragments. A quick release ratchet locks the jaws. Useful in general orthopaedics and for surgery around the hip, in particular:

- Femoral shaft fractures
- Triple pelvic osteotomy
- Hip toggle
- Fractures of the acetabulum

- 001216 Kern Bone Holding Forceps Mini 125mm Long
- 001213 Kern Bone Holding Forceps Small 170mm Long
- 001214 Kern Bone Holding Forceps Large 215mm Long
- 001213SET Kern Bone Holding Forceps Set of 3 (As above)

Self Centering Bone Holding Forceps



Some fracture reductions require that the bone forceps jaws be angled from the handles. Such forceps require:

- A sophisticated hinge mechanism to allow the jaws to maintain alignment as they open and close.
- A special locking device which can cope with the laxity at the hinge.

The spinlock and the special jaw makes the instrument very nice to use. The veterinary pattern stands up from the bone in use, where the human pattern sits down and falls away which is generally less appropriate in veterinary patients.

- 001209 Self Centering Bone Holding Forceps Very Small 150mm Long
- 001211 Self Centering Bone Holding Forceps Small 190mm Long
- 001212 Self Centering Bone Holding Forceps Large 240mm Long
- 001209V Self Centering Bone Holding Forceps Very Small 150mm Vet Pattern
- 001211V Self Centering Bone Holding Forceps Small 190mm Vet Pattern
- 001212V Self Centering Bone Holding Forceps Large 240mm Vet Pattern

Plate Holding/Drill Guide Forceps



Combination bone holder and drill guide. Allows temporary fixation of the plate to the bone whilst a hole is drilled. The ball shape of the tip engages the plate hole, while the tip of the drill guide engages the bone. Tips are offset slightly to avoid the drill bit hitting the opposite bone holder tip.

- 001225 1.5mm/2.0mm Plate Holding and Drill Guide Forceps 140mm Long
- 001226 2.4mm/2.7mm Plate Holding and Drill Guide Forceps 145mm Long
- 001227 3.5mm Plate Holding and Drill Guide Forceps 150mm Long
- 0012SET Plate Holding and Drill Guide Forceps Set of 3 (as above)

Plate Holding Forceps



Use to hold a plate in position on the bone. Ball tips engage the plate holes. Also useful as a fragment forcep in young, soft bone, as the balls prevent over penetration.

001215 Plate Holding Forceps 160mm Long

Left Handed Fragment Forceps



Left handed fragment forceps are modified specifically to make use easier. One black handle identifies left handed instruments.

001201SL-L Small Fragment Forceps With Spinlock 135mm Left Handed
001203-L Very Large Fragment Forceps With Spinlock 210mm Left Handed

Rongeurs

Rongeurs vary with respect to bite size and jaw angle. Where a rongeur has a specific function, it is indicated in the description.

Simple Action Rongeurs

Typically simple action rongeurs offer a wide bite but rely on the physical strength of the surgeon. Most small rongeurs have a simple action.

Vi Small Curved Rongeurs



A good general purpose rongeur for small bone nibbling procedures, e.g. excision arthroplasty, arthrodesis, sequestrum removal.

001300 Small Curved Rongeur 4mm Bite 170mm Long

Mini-Friedman



Useful in bulla osteotomy.

142501 Mini-Friedman Rongeur Curved 3mm Bite 160mm Long

Micro-Friedman



A small spine rongeur.

142502 Micro-Friedman Rongeur Curved 2.2mm Bite 155mm Long

Lempert Straight



Useful for spines and bulla osteotomy.

6730/10 Lempert Rongeurs Straight 3mm Bite 190mm Long

Compound Action Rongeurs

The compound action give a mechanical advantage to the surgeon but reduces the bite width.

Jansen



Compound action, powerful but small bite.

I42200 Jansen Rongeur Curved 4mm Bite 190mm Long

Ruskin



A heavy duty compound action rongeur.

I42270 Ruskin (Liston) Rongeur Compound Action Curved 6mm Bite 230mm Long

Stille-Luer



A very large rongeur.

I42305 Stille-Luer Heavy Compound Action Curved 8mm Bite 225mm

Duck-Billed Daniel Rongeurs



Designed by Simon Wheeler BVSc PhD, these Rongeurs can remove full thickness laminal bone in small dogs.

They are, however, best used to remove the layer of deep cortical bone overlying the spinal cord once the superficial cortex and cancellous bone have been removed using power tools; this is particularly true of the medium and large dog.

001400 Duck-Billed Daniel Rongeurs 3mm Bite 177mm Long

Micro Spine Rongeur Set

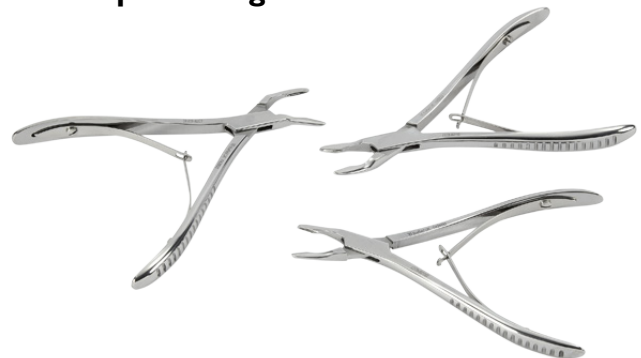

Very fine Rongeurs with a 1.75mm (width) bite. Set contains three variations: straight, curved and angled.

I42600 Micro Spine Rongeurs Set of 3

Daniel Rongeur



The jaws of this instrument are straight and the bite is small. Also suitable for bulla osteotomy.

001402 Daniels Rongeur Curved 4mm Bite 130mm Long

Compound Action Spinal Rongeurs



Much more powerful than the Daniels, this instrument can nibble through full thickness lamina. The jaws are very fine and angled to allow the surgeon to enlarge the inter-vertebral foramen.

Available in 2mm, 3mm, and 4mm jaw widths. Length 190mm.

- 001429 Compound Action Spinal Rongeurs 2mm
- 001430 Compound Action Spinal Rongeurs 3mm
- 001431 Compound Action Spinal Rongeurs 4mm

40 Degree Bone Punch Forceps - Low Profile



Designed for use where a high speed bur has removed the outer cortical layer and the underlying cancellous layer, the powerful nibbling action of this device allows very controlled removal of the final layer of cortical bone. The wedge-shaped foot of this device is designed to allow good access whilst still retaining strength, and is polished to minimise friction and potential trauma. Overall length 21cm.

- 001438 Batemans Spine Punch 40 Degree Upward Cut 2mm
- 001439 Batemans Spine Punch 40 Degree Upward Cut 3mm
- 001441 Batemans Spine Punch 40 Degree Upward Cut 4mm

Smith-Kerrison Punch Forceps



This is a traditional design with a 40 degree upward cutting jaw. Robust spine forceps. 185mm shaft.

- 001445 Smith-Kerrison Punch Forceps 2mm
- 001446 Smith-Kerrison Punch Forceps 3mm



Training & Education

Our e-learning platform delivers a variety of technical and clinical educational material, in an engaging and interactive format.

With a CPD certificate awarded upon successful completion of each module, the e-learning platform from Vi will help you to fulfil your annual CPD requirements.

Sign up today by scanning the QR code below.



Bone Cutters

Small Angled Cutters

A very useful small cutter. The jaw is angled to allow cutting where access is restricted, e.g. excision arthroplasty in cats and small dogs and tibial crest transposition. The design allows for transection of the tibial crest while retaining distal periosteal attachments. Also useful for articular cartilage removal in arthrodesis, digit and tail amputations.



001310 Small Angled Cutter 15mm Jaw 170mm Long

Compound Action Bone Cutters

All three following designs are similar but vary according to size of bite.

McIndoe



Compound jointed action gives power but reduces bite size.

141900 McIndoe Bone Cutter 15mm Blade Aof 170mm Long

Large Angled Cutters



Similar style to the Small Angled Cutters, but more powerful and more robust due to their size. The simple action allows a wider jaw opening. The angled jaws, more slender than similar sized Liston's, serves to further improve visibility and access into tight spots. The notch in the jaws serves to improve visibility further and make accurate cuts more achievable.

001311 Large Angled Cutters 19mm Jaw 230mm Long

Ruskin



Similar in design to McIndoe but larger.

141940 Ruskin (Liston) 25mm Blade Str 190mm Long
141960 Ruskin (Liston) 25mm Blade Aof 190mm Long

Liston



A widely used bone cutter with straight and angled jaw options.

141700 Liston Bone Cutters 25mm Blade Str 140mm Long
141710 Liston Bone Cutters 20mm Blade Aof 140mm Long
141730 Liston Bone Cutters 25mm Blade Str 170mm Long
141740 Liston Bone Cutters 25mm Blade Aof 190mm Long
141745 Liston Bone Cutters 30mm Blade Str 220mm Long
141755 Liston Bone Cutters 30mm Blade Str 190mm Long
141764 Liston Bone Cutters 30mm Blade Aof 200mm Long

Horsley



Heavy duty compound action cutters.

141660 Horsley Cutter 35mm Blade Aof 260mm Long
141660S Horsley Cutter 35mm Blade Str 260mm Long

Periosteal Elevators

Periosteal Elevator/Bone Lever



One end of this instrument is bent for use as a hook for retrieving and manipulating bone fragments. The other end is a periosteal elevator useful for clearing soft tissue from bone prior to plating, drilling or burring.

001270 Periosteal Elevator/ Bone Lever 4mm/7mm Tips 195mm

Freer Periosteal Elevator



The Freer Elevator is a fine instrument which is particularly useful in spinal work.

7350/05 Freer Periosteal Elevator 5mm 180mm Long

Howarth Dissector



Developed by Richard Whitelock specifically to clear soft tissues from the proximal tibia in the TPLO procedure. It is also useful as a general purpose periosteal elevator. One end acts as a curved periosteal elevator and the other end is straight.

001273 Howarth Dissector 225mm Long

AO Type Periosteal Elevator



The AO type instrument is the archetypal 'periosteal elevator'. Available in curved and square 6mm tip.

001271 AO Type Periosteal Elevator PTFE Handle Curved Tip 6mm 180mm
001274 AO Type Periosteal Elevator PTFE Handle Square Tip 6mm 190mm

Periosteal Elevator Very Fine



001272 Periosteal Elevator Very Fine 2mm/3mm 180mm Long

Molt Periosteal Elevator



The Molt is a double ended Periosteal Elevator. The tips are round and dished. 4mm and 6mm diameters.

001275 Molt Periosteal Elevator 200mm

MIPO Minimally Invasive Plate Osteosynthesis Elevator

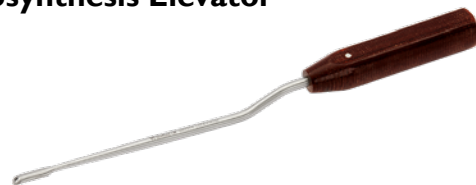

This instrument is not so much a periosteal elevator, more a dissecting probe to clear a tunnel under muscle layers for the plate. The periosteum is, in fact, left intact.

001276 MIPO Elevator 280mm Long

K/A Wire/Small Pin Punch



The cut ends of K wires, arthrodesis wires and small pins used for fragment fixation e.g. distal femoral fractures, should be buried beneath the bone or articular surface to minimise soft tissue irritation. The tip of the punch is concave to locate onto the pin end. The other end is struck with a mallet.

- 001360 K/A Wire & Small Pin Punch 135mm Long
- 001361 K/A Wire & Very Small Pin Punch 1.6mm Tip 135mm Long

IM Pin Punch



IM Pin Punch with a larger diameter tip for driving larger pins.

- 001374 IM Pin Punch 6mm Tip 135mm Long

Stubby Punch



The reduced working length allows the stubby punch to be held between thumb and forefinger much closer to the patient for increased control. This is especially useful when working without an assistant. 50mm long.

- 001363 Stubby Punch 50mm Long

K Wire Bender



Used to bend K and A wires prior to rotation and seating onto the bone. This instrument is designed to slip over the wire concentrating all the bending forces at the pin/bone interface. The instrument is double ended, the small end is for 0.9mm and 1.1mm wires, the large end is for 1.4mm, 1.6mm and 2.0mm wires.

- 001362 Kirschner and Arthrodesis Wire Bender 140mm Long

Offset Wire Bender



A robust design for the accurate and reliable creation of bends close to the bone surface. The three cannulations (1.1mm, 1.6mm and 2.0mm) cater for the full range of our arthrodesis wires. The short length of each cannulation makes these easy to clean.

- 001373 Offset Wire Bender

Offset K/A Wire Punch For Bent Pins



The bigger, angled foot of this punch is designed to allow bent-over arthrodesis or K wires to be driven home onto the bone surface. May also be used for Rush pins.

- 001364 Offset K/A Wire Punch For Bent Pins 135mm Long

Orthopaedic Hard Back Saw



Made from stainless steel. The stiff back helps to guide the saw.

- 001004 Orthopaedic Hard Back Saw

Adjustable Bone Saw



Useful for completing/squaring off the osteotomy, this saw comes complete with five, fine chrome plated blades. Blade length is adjustable from 40mm to 100mm. Handle length 130mm. Blade length 155mm.

- 001000 Adjustable Bone Saw With 5 Fine Blades
- 001001-A Spare Fine Blades Pack of 5 Chrome Plated
- 001000SS-A Adjustable Saw Blade Single Sterile
- 001002 Coarse Stainless Blade 140mm Long

Patella Saw



With standard sawblade including 1.5mm Allen Wrench.

- LEI23100590 Patella Saw
- LEI23100520 Patella Saw Replacement Blade
- LEI23100521 Patella Saw Allen Wrench

Osteotomes

Modular Osteotome



PTFE osteotome handle which accepts a good range of blades plus a diamond rasp (not included in set). Blades are 1.1mm thick, allowing fine cuts and reducing the incidence of breaking the block during block sulcoplasty procedures.

Replacement T wrench and retaining screw are also available.

001380	Modular Osteotome With 7 Blades
001382	Modular Osteotome Replacement Blade 4mm
001390	Modular Osteotome Replacement Blade 5mm
001383	Modular Osteotome Replacement Blade 6mm
001384	Modular Osteotome Replacement Blade 8mm
001385	Modular Osteotome Replacement Blade 10mm
001386	Modular Osteotome Replacement Blade 12mm
001387	Modular Osteotome Replacement Blade 15mm
001388	Modular Osteotome Replacement Blade 20mm
001389	Modular Diamond Rasp 6mm
TBHEX40	4.0mm T Bar Hex Driver
001380SCREW	Spare Screw For Modular Osteotome Handle

Osteotomes - Swedish Pattern



Use an osteotome to make a precise elective cut, e.g. trochanteric osteotomy, excision arthroplasty.

623880	Osteotome Swedish 30mm 205mm Long
623870	Osteotome Swedish 25mm 205mm Long
623860	Osteotome Swedish 20mm 205mm Long
623850	Osteotome Swedish 15mm 205mm Long
623840	Osteotome Swedish 12mm 205mm Long

Osteotomes - Light Pattern



Use an osteotome to make a precise elective cut, e.g. trochanteric osteotomy, excision arthroplasty.

001341	Osteotome Light 15mm 140mm Long
001342	Osteotome Light 12mm 140mm Long
001343	Osteotome Light 10mm 140mm Long
001344	Osteotome Light 8mm 140mm Long
001345	Osteotome Light 6mm 140mm Long
001346	Osteotome Light 4mm 140mm Long

Stubby Osteotome



Available from 3mm to 14mm and as a set. 70mm long.

001366	Stubby Osteotome 3mm 70mm Long
001367	Stubby Osteotome 4mm 70mm Long
001368	Stubby Osteotome 6mm 70mm Long
001369	Stubby Osteotome 8mm 70mm Long
001370	Stubby Osteotome 10mm 70mm Long
001371	Stubby Osteotome 12mm 70mm Long
001372	Stubby Osteotome 14mm 70mm Long
0013SET	Stubby Osteotome Set of 7 (As above)

Chisels

Chisels Swedish Pattern



Use a chisel where heavier bone removal is required, e.g. sequestrum removal.

- 162340** Chisel Swedish Pattern 12mm 205mm Long
- 162350** Chisel Swedish Pattern 15mm 205mm Long
- 162360** Chisel Swedish Pattern 20mm 205mm Long

Orthopaedic Mallet



For use with osteotomes, chisels, gouges and staples. Different weights are available according to surgeon preference and patient size.

- 001323** Mallet 140g 155mm Long
- 001320** Mallet 300g 220mm Long
- 001321** Mallet 500g 240mm Long
- 001325** Nylon Faced Mallet 500g 240mm Long
- 001326** Nylon Faced Mallet 300g 205mm Long

Chisels Light Pattern



Use a chisel where heavier bone removal is required, e.g. sequestrum removal.

- 001350** Chisel 12mm 140mm Long
- 001351** Chisel 10mm 140mm Long
- 001352** Chisel 8mm 140mm Long
- 001353** Chisel 6mm 140mm Long
- 001354** Chisel 4mm 140mm Long

Volkman Bone Scoop



Useful for heavy curettage and collection of cancellous bone grafts.

- 782205** Volkman Single Ended Scoop 3mm 170mm Long
- 782200** Volkman Single Ended Scoop 4mm 170mm Long
- 782210** Volkman Single Ended Scoop 5mm 170mm Long
- 782220** Volkman Single Ended Scoop 6mm 170mm Long
- 782600** Volkman Double Ended Scoop Small 4mm/6mm 200mm Long
- 782610** Volkman Double Ended Scoop Medium 5mm/6mm 200mm Long
- 782620** Volkman Double Ended Scoop Large 6mm/8mm 200mm Long

Gouges



Use a gouge where bone contouring is essential.

- 001355S** Gouge 12mm 140mm Long
- 001355** Gouge 12mm 205mm Long
- 001356** Gouge 10mm 140mm Long
- 001357** Gouge 8mm 140mm Long
- 001358** Gouge 6mm 140mm Long
- 001359** Gouge 4mm 140mm Long

Trephine



Stainless steel and re-usable with a retractable stylet. Extend the stylet to provide secure location at the trephine site until trephine teeth bite. Withdraw the stylet to harvest the bone. Push the bone core out using the stylet. Where a very long core is required the stylet may be removed completely.

- Creation of window for bone graft harvest.
- Cortical bone biopsy.

001425 Trephine 8mm o/d 6mm Core 170mm Long

001426 Trephine 6mm o/d 4mm Core 115mm Long

001427 Trephine 5mm o/d 3mm Core 115mm Long

Small Distractor With Ratchet



The Small Ratcheted Distractor uses 1.5 or 1.6 K or A wires as distraction pins. The pins are driven into place through the tubes on the distractor arm. Threaded pins may be used for additional security. Squeezing the arms of the distractor separates the pins and thus the bone fragments and the ratchet holds them in the new position. Range of distraction 12mm - 60mm.

001503 Small Distractor With Ratchet 185mm Long

Vi Pattern Orthopaedic Distractor



Application and Features:

- Overcoming muscle contraction prior to fracture reduction.
- Accurate alignment of bone fragments prior to plating.
- Locking wing nuts fix the distractor as a scaffold for the bone fragments to facilitate plating.
- Three joints maximise flexibility.
- Use with external fixation pins 3.2mm to 4.0mm.

001500 Vi Pattern Orthopaedic Distractor 330mm Long

Bone Scribe



A very sharp marking point with an easy-to-hold handle enables the surgeon to mark bone prior to creation of an osteotomy. One end is pointed and the other is sharpened as a blade.

001494 Bone Scribe Double Ended 200mm Long

Measuring Devices

Vernier Caliper



Useful for very accurate measurement of screws and drill bits. Accurate to 0.1mm.

001490 Vernier Caliper Stainless Steel

001490D Digital Vernier (Non Autoclavable)

Drill & Screw Gauge



Measures screws up to 60mm and drills from 1.1mm to 3.5mm.

001496 Drill & Screw Gauge 60mm Long

Vi Metric Ruler

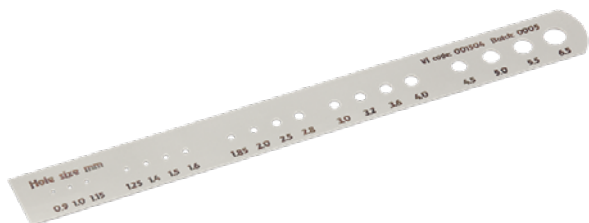

Metric ruler covering the more common drill, screw and wire sizes.

001504 Metric Ruler - Vi

Imperial Ruler

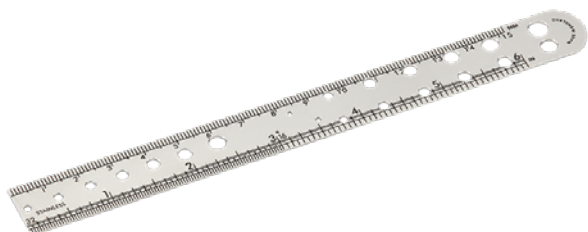

Used to measure pins, wires, drills and screw sizes.

001498 Orthopaedic Ruler Imperial 175mm Long

Radiographic Aids Xray Marker With Scale



A reliable scale is very important, regardless of the system used. Left/right markers are essential. A flexible stand is also available allowing this combined marker to be positioned at the same level as the area of interest to improve accuracy.

XRAYMARK I Xray Marker With Scale Set Left & Right
XRAYHOLD I Xray Marker Stand

Radiographic Reference Ball



Reduce scaling errors when templating for implants or examining structures, using digital or analogue systems. Using a spherical object as a reference eliminates errors created by ruler orientation which might not be quite parallel with the plate.

Supplied on a stable base with a flexible neck, allowing positioning at the same level as the area of interest.

XRAY25MM Radiographic Reference Ball 25mm Diameter
XRAY10MM Radiographic Reference Ball 10mm Diameter
XRAYBALLSET Xray Ball Set 25mm & 10mm

Implant Cutters

Select implant cutters to suit the type and size of implant to be cut, and the position of the implant. Using hacksaws is best avoided as far as possible – due to the work hardening characteristic of stainless steel and titanium, the harder you work the harder it is to cut. Intramedullary pins and K/A wires are already hardened during production so are even tougher.

Designs and finish of cutter:

Surgical finish stainless steel with TC inserts – suitable for appropriate sizes of hard wires. Can be used for appropriate sizes of cuttable plate. Also for cutting fish hooks!

Side cutting – standard pattern straight cutters.

Close cut – end cutting. For smaller pins only. Harder to cut long sections but allow cutting close to the bone.

Safety cutters – leave a blunt end with no snags, but leave a longer stub. Best for ex fix pins.

Compound action – more expensive but make cutting pins easier.

Prolong the life of your pin cutter by not cutting at the tip – as tungsten carbide is brittle, it is prone to break when cutting at the very tip, where it is less well supported by the stainless jaw.

Implant Cutter Selection Chart

Maximum Pin Size	Code	Description
1.5mm	001230	Implant Cutter to 1.5mm
	001238	Implant Cutter to 1.5mm Close Cut
2.0mm	001237/1	Implant Cutter to 2.0mm 255mm
2.2mm	001246	Implant Cutter to 2.2mm Oblique jaw
	001237	Implant Cutter to 2.2mm
	001236	Implant Cutter to 2.2mm Close Cut
3.0mm	001228	Implant Cutter to 3.0mm
4.0mm	001234	Implant Cutter to 4.0mm
	001231/A	Implant Cutter to 4.0mm Detachable Handles
	001229	Safety Cutter to 4.0mm
6.0mm	001231VL	Implant Cutter to 6.0mm Compound



Implant Cutter Surgical Finish To 1.5mm Capacity



Implant Cutter Surgical Finish to 1.5mm Capacity, 150mm Long.

001238 Implant Cutter Stainless To 1.5mm Capacity Close Cut 150mm Long

Implant Cutter Surgical Finish To 1.5mm Capacity



Small lightweight implant cutter. Max capacity 1.5mm. Also suitable for 1mm cuttable plate range. For light use only.

001230 Implant Cutter Stainless To 1.5mm Capacity 170mm Long



Email Marketing Service

Our marketing emails are designed to **educate**, to keep you up to date with what's new at Vi and share **exclusive offers and discounts**.

Sign up today by scanning the QR code below.



Implant Cutter Surgical Finish To 2.0mm Capacity



Implant Cutter Stainless Steel Cuts To 2.0mm Capacity 255mm Long Simple Action.

001237/1 Implant Cutter Stainless Steel Cuts To 2.0mm Capacity 255mm Long Simple Action

Implant Cutter Surgical Finish To 2.2mm Capacity



Implant cutter surgical finish with TC jaws. End cut to 2.2mm capacity. Sprung compound action. 230mm long.

001236 Implant Cutter Stainless Steel Cuts To 2.2mm Capacity 230mm Long End Cut

Implant Cutter Surgical Finish To 2.2mm Capacity

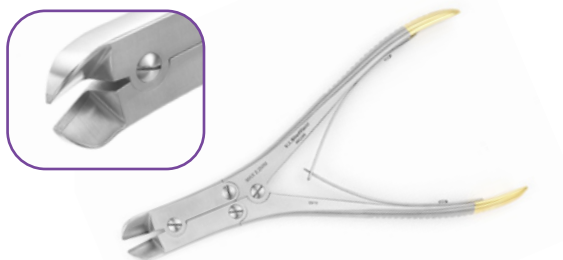

Similar to 001237, but with oblique jaws favoured by many surgeons. Tungsten Carbide jaws.

001246 Implant Cutter Stainless Steel Cuts To 2.2mm Capacity 255mm Long

Implant Cutter Surgical Finish To 3mm Capacity



Implant Cutter Surgical Finish to 3mm Capacity, TC Jaws, 255mm Long.

001228 Implant Cutter Stainless To 3mm Capacity 255mm Long

Implant Cutter Surgical Finish To 2.2mm Capacity



Implant Cutter Surgical Finish to 2.2mm Capacity, TC Jaws, Sprung Compound Action, 230mm Long.

Very useful for A and K wires, and cuttable plates.

001237 Implant Cutter Stainless Steel Cuts To 2.2mm Capacity 230mm Long

Implant Cutter Surgical Finish To 4mm Capacity Detachable Handles



Overall length with handles in situ is 485mm. Strips down to 270mm long when handles are detached to fit many smaller autoclaves.

001231/A Implant Cutter Stainless To 4mm Capacity Detachable Handles

Safety Cutter Surgical Finish To 4mm Capacity



Safety implant cutter which leaves a smoother cut end than a conventional cutter. Very useful for external fixation pins. Cut end is temporarily retained within the head rather than flying off.

Maximum capacity 4mm. Cuts 5mm below the face of the cutter.

Telescopic handles reduce the overall length from 470mm to 340mm to fit most autoclaves. Head strips for cleaning.

001229 Safety Cutter Stainless Steel Cuts To 4.0mm Capacity 340mm Long

Implant Cutter Surgical Finish To 6mm Capacity



Highest capacity implant cutter stocked. Will not fit most autoclaves as they are 560mm long – suggested to use chemical sterilant on the jaws and operate by an unscrubbed assistant.

001231VL Implant Cutter Stainless Steel Cuts To 6mm Capacity TC Jaws 560mm Long

Implant Cutter Surgical Finish To 4mm Capacity



001234 Implant Cutter Stainless Steel Cuts To 4mm Capacity TC Jaws 370mm Long



ViPP

Through a true partnership approach, you can deliver quantifiable rewards for you and your Practice by joining our **Veterinary Instrumentation Partnership Programme**.

To find out more, scan the QR code below.



Pin & Wire Extraction Pin Grip



For the removal of temporary fixation pins. Narrow jaws allow access via a small incision, with a groove in the jaw to locate the pin. Jaws can be locked in position once the pin is located, to aid removal.

001241 Pin Grip Stainless Steel Modified Jaw 175mm Long

Dental Forceps For Pin & Wire Extraction



For pin, wire and screw extraction. Grooved tips come to a point, allowing work in confined spaces and close to bone with a reduced surgical approach. Anatomical handles and cranked jaws for ease of use.

001248 Dental Forceps for Pin & Wire Extraction

Parallel Action Pliers



Useful for bending, holding and cutting small pins and wires. Used in conjunction with bone plate benders for contouring smaller plates. Will cut arthrodesis and K wires to a maximum of 2.0mm with care.

001290 Parallel Action Pliers Stainless Steel 170mm

Wire Contouring Pliers



Use to contour both soft and hard wires. The jaw design has multiple anvil shapes and a pair of soft wire cutters.

001245 Wire Contouring Pliers 150mm Long

Kirschner and Arthrodesis Wire Remover



Designed to firmly grip wires 0.9mm to 2.0mm. Tungsten Carbide jaws maximise grip, fine nose minimises trauma to surrounding tissue.

001244 Kirschner and Arthrodesis Wire Remover 140mm Long

Small Pin Vice



This Small Pin Vice holds pins and wires up to a diameter of 1.0mm. Particularly useful for fingertip control over insertion of Arthrodesis and K Wires.

001223 Small Pin Vice 100mm Long

Jacobs Chuck



Standard instrument for for hand insertion of intramedullary pins.

Pin capacity Standard Chuck up to 1/4" (6mm)

Small Chuck up to 5/32" (4mm)

Standard chuck will grip small pins, but is heavier in use.

Clean thoroughly and lubricate well, opening and closing jaws fully during cleaning procedure to maintain in good condition.

001220	Small Jacobs Chuck with Handle 5/32" Capacity 260mm
001605S	Replacement 5/32" Chuck & Key Only - No Handle
001606S	Spare Key For 5/32" Chuck
001221	Standard Jacobs Chuck with Handle 1/4" Capacity
001605	Replacement 1/4" Chuck & Key Only - No Handle
001606	Spare Key For 1/4" Chuck

Wire Passers



Wire passers are designed to direct cerclage wire around long bones with minimal trauma, helping reduce devascularisation of fragments. Soft tissue attachments should be preserved as far as possible.

001250	Wire Passer Double-Ended 145mm
001252	Wire Passer Single-Ended 20mm Diameter 205mm
001253	Wire Passer Single-Ended 30mm Diameter 220mm
001254	Wire Passer Single-Ended 40mm Diameter 250mm
001256	Wire Passers Single-Ended Set of 3 (As Above)

Strong Cerclage Wire Passers



Low profile open channel wire passers, designed to allow easier passage around and between bones. Can be left in situ as wire is tightened, reducing risk of slippage. Wire can be passed from tip or handle. With a flat internal tip to assist close passage around the bone.

Designed by David Strong MRCVS.

CWPSM	Strong Cerclage Wire Passer Small 12.5mm/15mm
CWPMO	Strong Cerclage Wire Passer Medium 20mm/25mm
CWPLG	Strong Cerclage Wire Passer Large 30mm/40mm
CWPSET	Strong Cerclage Wire Passer Set of 3

Lesser Wire Passer/Retrieval Forceps



Really useful forceps which combine the function of a tissue protector drill guide with a method of capturing the wire on the blind side of the procedure. The open sided guide tube is toothed to minimise drill skate.

Most common applications include hemi-cerclage and passage of lateral sutures through the tibial crest.

Original design by Arnie Lesser.

001268	Lesser Wire Passer/Retrieval Forceps 150mm Long
001269	Lesser Wire Passer/Retrieval Forceps Large 190mm Long

Orthopaedic Wire



Cerclage wire is an extremely useful method of fragment fixation. Use as thick a wire as seems possible. Twist evenly under tension. The best instrument is our Wire Twister/Cutter 001260. Minimise wire movement on periosteum. Tension wire banding should be performed where muscular forces must be transferred beyond a fracture or osteotomy, e.g. Tibial crest avulsion or trochanteric osteotomy. 1.0mm wire is the most useful for mid-sized dogs. All are supplied in 10 metre rolls.

- OW0210** 32g Reel of Orthopaedic Wire 0.20mm
- OW0310** 30g Reel of Orthopaedic Wire 0.30mm
- OW0410** 27g Reel of Orthopaedic Wire 0.40mm
- OW0510** 25g Reel of Orthopaedic Wire 0.5mm
- OW0610** 24g Reel of Orthopaedic Wire 0.6mm
- OW0710** 22g Reel of Orthopaedic Wire 0.71mm
- OW0810** 21g Reel of Orthopaedic Wire 0.8mm
- OW0910** 20.5g Reel of Orthopaedic Wire 0.9mm
- OW1010** 20g Reel of Orthopaedic Wire 1.0mm
- OW1012** 18g Reel of Orthopaedic Wire 1.2mm
- OW1015** 16g Reel of Orthopaedic Wire 1.5mm



Orthopaedic Wire Kit



Cerclage wire can be a very useful means of fragment fixation. Kit containing our most popular cerclage instruments and a roll of wire, discounted over component price.

Kit contains:

- | | | |
|--------|------------------------------------|----|
| 001260 | Wire Twister | x1 |
| 001256 | Set of 3 Single Ended Wire Passers | x1 |
| OW1010 | 10m Roll of 1.0mm Orthopaedic Wire | x1 |

OWKIT Orthopaedic Wire Kit

Wire Twister and Shear Cutter



- Jaws lock onto wire to enable easy twisting under tension for kink-free cerclage. The wire must be twisted under tension to create an even spiral.
- Long life shear action cutter will cut 18 gauge (1.2mm) wire twisted double.
- Serrated jaws grip and turn cut ends.
- 001260 have fenestrated jaws. Not Tungsten Carbide.
- 001261 have Tungsten Carbide jaws for extra grip. Not fenestrated.
- Not designed to cut A + K Wires, Pins or fish hooks.

- 001260** Wire Twister and Shear Cutter 165mm Long
- 001261** Wire Twister and Shear Cutter - Tungsten Carbide Jaws 165mm Long

Wires With Eyelet

The free end of the wire is threaded through the eye. The cerclage is tightened using the special tightener. Requires a device for tightening Eyed Wires, see 001262 and 001264.

- CWWE22** Orthopaedic Wire With Eyelet 22g x 12" Pack of 6
- CWWE20** Orthopaedic Wire With Eyelet 20g x 12" Pack of 6
- CWWE18** Orthopaedic Wire With Eyelet 18g x 12" Pack of 6

Wire Tightener For Eyed Wires



Used to tension eyed wires very tightly. The cerclage is finished by kinking the wire back against the eye.

- 001262** Wire Loop Tightener 125mm Long

Wire Tightener With Two Cranks



Use with single crank for eyelet wires. Use both cranks to tighten double loops.

- 001264** Wire Tightener With Two Cranks 240mm Long

Plaster Cutting



Simple action serrated jaw. Very robust and comfortable to use. Very efficient for removing bandages.

161405 Plaster Shears Bruns/Bohler 245mm Long

Plaster Spreaders



Cast spreader scaled to veterinary patients, to expand the initial cut made to remove a cast.

161410 Plaster Spreaders 230mm

Plaster Shears Stille



Very powerful compound action.

161406 Plaster Shears Stille 245mm Long

Biopsy Needles

Biopsy Needle	Patient Body Weight	Needle Gauge
Bone Marrow	<5kg	18g
	5-15kg	15/16g
	15-30kg	13g
	30-50kg	11g
	>50kg	8g
Cortical Bone	<5kg	11g
	5-15kg	8g
	>50kg	Trephine

Trephines can be found on page 19

Bone Marrow Biopsy - Jamshidi Type

In the Jamshidi Type Needle the integral stylet locks into the lumen of the needle preventing obstruction by debris. When the needle tip is in the desired location the stylet is removed and the sample aspirated.

The 11 gauge needle with the stylet removed may be used to take a 1.5mm approx. core of bone from tumours for typing.

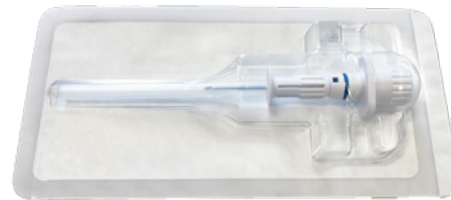

XS15030-00 15g Disposable Illinois Style Bone Marrow Biopsy Needle

VI Jamshidi Type Range



Drive into a suitable site (wing of ilium, tuber ischium, proximal femur), pull back a little, withdraw stylet and aspirate. If there is no aspirate, replace stylet, push in further and repeat.

- BMBJV16** VI Jamshidi Type Disposable 16g
- BMBJV13** VI Jamshidi Type Disposable 13g
- BMBJV11** VI Jamshidi Type Disposable 11g
- BMBJV8** VI Jamshidi Type Disposable 8g

Bone Marrow Biopsy - Rosenthal



Stylet does not lock into position.

012509 Bone Marrow Biopsy Rosenthal 16g x 35mm

Intraosseous Infusion Needle 18g

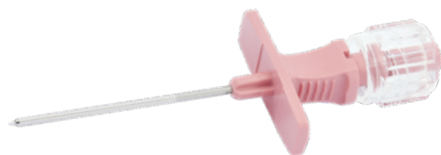

Where vascular access is difficult, fluids and most drugs can be administered via this intraosseous infusion needle. This process is particularly useful in neonates and birds where blood vessels are very small.

The most common site is the proximal femur via the trochanteric fossa. An IV catheter should be placed as soon as practical. Also used as a small bone marrow aspiration needle in the Jamshidi style.

BMBJV18 Intraosseous Infusion Needle 18g

Table Top Stand For Hanging Limb Preparation

Suspension of a limb can provide significant benefits in both arthroscopy and other orthopaedic procedures. The shoulder joint is distracted and 360 degree access becomes available. Height 1.2m (48"). Great table-top stability and a cleat for tying of limb suspension ropes. The shaft can be dismantled for storage.



R463 Tabletop Stand For Hanging Limb Preparation

Multi Arm With Limb Brace Attachment

Safety need not be compromised to obtain accurately positioned radiographs. The Multi Arm can replace the human hand in the positioning and holding of limbs for both radiography, surgery and arthroscopy. Also useful for hands-free positioning of bronchoscopes and gastroscopes.

- Use cohesive bandage to attach limb.
- Three joints allow positioning at any angle.
- A single knob locks all three joints rigid.
- Clamp fixes device to virtually any operating or X-ray table.
- Double limb support for hip radiographs available as an option.
- As described by Kurt Schulz in Veterinary Surgery.



026000 Multi Arm - Includes Single Limb Support



020062 Double Limb Support for MultiArm



020065 Limb Brace Attachment For Multi Arm

MULTIARMSET Multi Arm Set - Contains 026000, 020062 and 020065

Veterinary Tissue Bank

Veterinary Tissue Bank is Europe's first tissue bank providing allograft tissues for companion animals. Bone allografts are available in various presentations & have many applications for use during procedures such as from TTA Rapid & joint arthrodesis to dealing with difficult non-union case.

Bone allografts are prepared from natural bone which has been processed to remove soft tissues, cells and bone marrow elements, and are freeze dried & irradiation sterilised after packing for sterility. The products are rehydrated with isotonic solution at the time of use to make like wet sand for better handling. The product is available off the shelf, ambient temperature storage and carries a few years of shelf life.

All products are subject to availability

Cancellous Chips



Cancellous Chips, prepared from trabecular bone, offer structural to a graft as well as providing a scaffold for osteoconduction. They are available in 3 different chip sizes for closer matching to defect size.

Useful in TTA Rapid, filling corrective osteotomies, fracture repair among other procedures. It is also useful for extending an autograft where harvesting has not produced sufficient quantity.



- C0101** Cancellous Chips Canine 2-4mm Chip Size Coarse 1cc
- C0103** Cancellous Chips Canine 2-4mm Chip Size Coarse 3cc
- C0105** Cancellous Chips Canine 2-4mm Chip Size Coarse 5cc



- C0201** Cancellous Chips Canine 1-2mm Chip Size Medium 1cc
- C0203** Cancellous Chips Canine 1-2mm Chip Size Medium 3cc
- C0205** Cancellous Chips Canine 1-2mm Chip Size Medium 5cc



- C0301** Cancellous Chips Canine <1mm Chip Size Fine 1cc
- C0303** Cancellous Chips Canine <1mm Chip Size Fine 3cc
- C0305** Cancellous Chips Canine <1mm Chip Size Fine 5cc
- FL105** Cancellous Chips Feline <2mm Chip Size Fine 1cc

DBM Products



Demineralised Bone Matrix (DBM), prepared from cortex, contains endogenous Bone Morphogenic Proteins (BMPs). Osteoinduction which is attributed to the presence of BMPs refers to the capability of inducing new bone formation when implanted in heterogenous site. DBM is used in procedures where fusion of bone or joint is needed such as in arthrodesis, spinal fusion and fracture repair.

DBM is available in 2 different particle sizes.

Graft Selection

Osteoinduction	—————>	DBM
Osteoconduction	—————>	Cancellous Chips
Osteoconduction and osteoinduction	—————>	DBM Putty/Fibres

Canine DBM 0.1 - 0.5mm

- C0901** DBM Canine 0.1-0.5mm Granules 1cc
- C0903** DBM Canine 0.1-0.5mm Granules 3cc
- C0905** DBM Canine 0.1-0.5mm Granules 5cc

Canine DBM 0.5 - 1.0 mm

- C1001** DBM Canine 0.5-1.0mm Granules 1cc
- C1003** DBM Canine 0.5-1.0mm Granules 3cc
- C1005** DBM Canine 0.5-1.0mm Granules 5cc

Feline DBM <1mm

- FL205** DBM Feline 1.0mm 0.5cc

DBM putty in syringe



Ready to use, premix DBM which is injectable as well as mouldable.

- DBMPUTC1101** VTB DBM Putty 1cc (Premixed)

DBM Fibres



DBM fibres product, prepared from cortex, contains endogenous BMPS, hence, is osteogenic. In addition, the scaffold matrix offers superior osteoconduction for cell migration. The product is easy to rehydrate.

- CI201** Canine VTB DBM Fibres 1cc
- CI203** Canine VTB DBM Fibres 3cc
- CI205** Canine VTB DBM Fibres 5cc

NanoPaste Bone Substitute

Use to save time harvesting autograft or when the quality of the autograft is poor. NanoPaste will extend autograft.

The sterile presentation is an aqueous paste supplied in a syringe (2.5ml or 5.0ml). The paste may be injected directly into a defect where it conforms to fill the space. The paste is readily colonised by bone cells and acts as a scaffold encouraging penetration of host bone. The putty-like consistency means that the paste may be pressed onto bone where it sticks until resorbed.

Nano HA paste conforms to ENISO 13779-1:200 and ASTM F1185-88 for medical grade HA.

Applications include: joint arthrodesis, TTA Rapid, non-unions, delayed unions and filling spine cages.

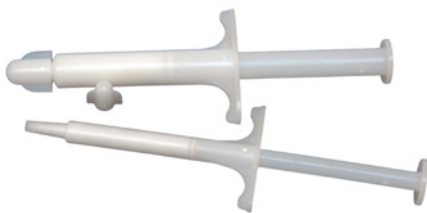

- PAS2.5** NanoPaste Syringe 2.5ml
- PAS5** NanoPaste Syringe 5ml

Joint Surgery



To view the Joint Surgery section of our website, please scan the QR code.



Did you know Vi offers free online CPD?



The Vi website has you covered with a comprehensive range of CPD services and resources, all in one convenient location!

SURGERY GUIDES

You can find the following surgery guides on the Vi website:

- LigaFiba® Isotoggle
- LigaFiba® Lateral Button Suture
- Lateral Suture
- The Essentials of Fracture Management
- Fixation of Long Bone (Diaphyseal) Fractures Using Locking Plates and Screws
- Fixation of Long Bone (Diaphyseal) Fractures Using Non-Locking Plates and Screws
- Patellar Luxation
- TPLO (Tibial Plateau Levelling Osteotomy)
- TTA (Tibial Tuberosity Advancement)
- TTO (Triple Tibial Osteotomy)
- Linear External Skeletal Fixation
- BOAS Surgery



Scan to view all guides

WEBINARS

Vi regularly hold free webinars with guest speakers on a vast range of specialist areas, including fracture fixation, wound closure and infection prevention, patella luxation, and many more! All webinars are recorded and can be accessed via the Vi E-Learning Platform.



Scan to view all

UPCOMING COURSES AND EVENTS

Each year Vi supports the facilitation of over 165 CPD courses, both within the UK and internationally. The Vi website contains a calendar of all upcoming CPD courses and events for the months ahead.

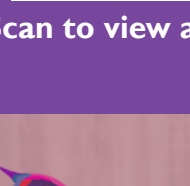

Scan to view all



Sign up to Vi's FREE E-Learning Platform

for a variety of engaging and interactive educational material to fit around your schedule.



Vi Locking TPLO Starter Kit

Our range of TPLO kits are an excellent way to obtain the appropriate equipment which enables you to complete the TPLO procedure. Available with or without our battery powered TPLO saw.



Vi TPLO Starter Kit contains:

VILTPLOSAW	Vi Battery Powered TPLO Saw W/ Charger & Batteries	x1
001492	Slocum Type Rotation Gauges 5mm To 15mm	x1
001494	Bone Scribe (200mm Long)	x1
TPLOROT	TPLO Rotation Chart	x1
TPLO32	Slocum Guide 3.2mm (1/8") x 125mm Pins For TPLO 25mm Thread	x10
TPLOJIG	TPLO Basic Jig	x1
TPLOVI18	TPLO Blade Vi Pattern 18mm	x1
TPLOVI21	TPLO Blade Vi Pattern 21mm	x1
TPLOVI24	TPLO Blade Vi Pattern 24mm	x1
VILTPLO27L3	Locking TPLO Plate For 2.7mm Screws 3 Holes Proximal Left	x1
VILTPLO27R3	Locking TPLO Plate For 2.7mm Screws 3 Holes Proximal Right	x1
VILTPLO35BL4	Locking TPLO Broad Plate For 3.5mm Screws 4 Holes Proximal Left	x1
VILTPLO35BR4	Locking TPLO Broad Plate For 3.5mm Screws 4 Holes Proximal Right	x1
VILTPLO35L3	Locking TPLO Plate For 3.5mm Screws 3 Holes Proximal Left	x2
VILTPLO35R3	Locking TPLO Plate For 3.5mm Screws 3 Holes Proximal Right	x2

VILTPLOKITBAT Vi TPLO Locking Starter Kit With Battery Saw Power

VILTPLOKITNP Vi TPLO Locking Starter Kit has the same components as the kit list above excluding the VILTPLOSAW.

VILTPLOKITNP Vi TPLO Locking Starter Kit With No Power Equipment

Vi TPLO Starter Kit in Modular Plating Box contains:
Modular Plating Box and 3 Instrument Trays.

UDG27	Universal Drill Guide for 2.7mm Screws	x1
UDG35	Universal Drill Guide for 3.5mm Screws	x1
LSDG2724XL	Locking Screw Drill Guide For 2.7mm Screws XL	x1
LSDG35XL	Locking Screw Drill Guide For 3.5mm Screws XL	x1
TPLOJIG	TPLO Basic Jig	x1
TPLO32	Slocum Guide 2.3x125mm Pins F/ TPLO 25mm Thread	x3
001529	1.6mm Ellis Pin 85mm	x2
001492	Slocum Rotation Gauges 5-15mm	x1
001494	Bone Scribe 200mm	x1
001499	TPLO Rotational Gauge Divider	x1
TPLOROT	TPLO Rotation Chart	x1
DGP2735	Premium Depth Gauge F/ 2.7/3.5mm Screws	x1
E17-079	Soft Touch QR Inline Handle W/ AO Coupling Yellow	x1
SDT1535	Star Drive T15 Insert F/ 3.5mm Locking Screws	x1
SDT82427	Star Drive T8 Insert F/ 2.4/2.7mm Locking Screws	x1
TPLOVI18	TPLO Blade Vi Pattern 18mm	x1
TPLOVI21	TPLO Blade Vi Pattern 21mm	x1
TPLOVI24	TPLO Blade Vi Pattern 24mm	x1
MPBSC27-MIX	2.7mm Screw Caddy With Star Drive Locking & Cortical Screws	x1
MPBSC35-MIX	3.5mm Screw Caddy With Star Drive Locking & Cortical Screws	x1
VILTPLO27L3	2.7mm Locking TPLO Plate 3 Hole Proximal Left	x2
VILTPLO27R3	2.7mm Locking TPLO Plate 3 Hole Proximal Right	x2
VILTPLO35L3	3.5mm Locking TPLO Plate 3 Hole Proximal Left	x2
VILTPLO35R3	3.5mm Locking TPLO Plate 3 Hole Proximal Right	x2
VILTPLO35SL3	3.5mm Small Locking TPLO Plate 3 Hole Proximal Left	x2
VILTPLO35SR3	3.5mm Small Locking TPLO Plate 3 Hole Proximal Right	x2
H090102	2mm Shank Drill 110mm Round	x1
H090103	2.8mm Shank Drill 130mm Round	x1
H090112	2.5mm Shank Drill 120mm Round	x1

VILTPLOKIT-I Vi Locking TPLO Kit 2735 No Power

VILTPLOKIT-IQC Vi TPLO Kit 2735 Drill Bits No Power has the same components as the kit list above but includes QC drill bits instead of round shank.

VILTPLOKIT-IQC Vi TPLO Kit 2735 Drill Bits No Power

To view our Surgery Guide on TPLO, please scan the QR code below.



Small Vi Locking TPLO Starter Kit

We have now also launched smaller locking TPLO kits due to the trend of smaller dog breeds requiring this type of surgery.



Vi TPLO Locking Kit With 1.5mm/2.0mm/2.7mm Plates contains:

VITPLOSAW	Vi Battery Powered TPLO Saw W/ Charger & Batteries	x1
VILTPLO15L3	Locking TPLO Plate For 1.5mm Screws Left	x2
VILTPLO15R3	Locking TPLO Plate For 1.5mm Screws Right	x2
VILTPLO20L3	Locking TPLO Plate For 2.0mm Screws Left	x1
VILTPLO20R3	Locking TPLO Plate For 2.0mm Screws Right	x1
VILTPLO27L3	Locking TPLO Plate For 2.7mm Screws Left	x1
VILTPLO27R3	Locking TPLO Plate For 2.7mm Screws Right	x1
TPLOV112	TPLO Blade Vi Pattern 12 mm	x2
TPLOV115	TPLO Blade Vi Pattern 15 mm	x1
TPLOJIGXS	XSTPLO Jig 60mm	x1
TPLO32	Slocum Guide 3.2 x 125mm Pins For TPLO 25mm Thread	x1
001492	Slocum Rotation Gauges 5 - 15mm	x1
TPLOROT	TPLO Rotation Chart	x1
001494	Bone Scribe 200mm	x1

VILTPLOKITBATXS Vi TPLO Locking Kit With 1.5mm/2.0mm/2.7mm Plates

VILTPLOKITXSNP Vi TPLO Locking Starter Kit has the same components as the kit list above excluding the VITPLOSAW.

VILTPLOKITXSNP Vi TPLO Locking Starter Kit With No Power Equipment

Vi TPLO Starter Kit in Modular Plating Box contains:

Modular Plating Box and 3 Instrument Trays.

UDG20	Universal Drill Guide for 2.0mm Screws	x1
UDG24	Universal Drill Guide for 2.4mm Screws	x1
LSDG20	Locking Screw Drill Guide for 2.0mm	x1
LSDG2424	Locking Screw Drill Guide For 2.4mm	x1
TPLOJIGXS	XSTPLO Jig 60mm	x1
001529	1.6mm Ellis Pin 85mm	x4
001550	2.0mm Ellis Pin 127mm	x4
001492	Slocum Rotation Gauges 5-15mm	x1
001494	Bone Scribe 200mm	x1
001499	TPLO Rotational Gauge Divider	x1
TPLOROT	TPLO Rotation Chart	x1
DGP2024	Premium Depth Gauge F/ 2.0/2.4mm Screws	x1
E17-079	Soft Touch QR Inline Handle W/ AO Coupling Yellow	x1
D17-080	Soft Touch QR Inline Handle W/ Dental Coupling Grey	x1
SDT620-A	Star Drive T6 Inset for 2.0mm Locking Screws	x1
SDT82427	Star Drive T8 Inset for 2.4/2.7mm Locking Screws	x1
TPLOV112	TPLO Blade Vi Pattern 12mm	x1
TPLOV115	TPLO Blade Vi Pattern 15mm	x1
TPLOV118	TPLO Blade Vi Pattern 18mm	x1
MPBSC20-MIX	2.0mm Screw Caddy With Star Drive Locking & Cortical Screws	x1
MPBSC24-MIX	2.4mm Screw Caddy With Star Drive Locking & Cortical Screws	x1
VILTPLO20L	2.0mm Locking TPLO Plate 3 Hole Proximal Left	x2
VILTPLO20R	2.0mm Locking TPLO Plate 3 Hole Proximal Right	x2
VILTPLO24L	2.4mm Locking TPLO Plate 3 Hole Proximal Left	x2
VILTPLO24R	2.4mm Locking TPLO Plate 3 Hole Proximal Right	x2
H090101	1.5mm Shank Drill 90mm Round	x1
H090208	1.8mm Shank Drill 110mm Round	x1

VILTPLOKIT-2 Vi Locking TPLO Kit 2.0/2.4 No Power

VILTPO Locking TPLO Plates



Key design features:

- Contoured to the shape of the post TPLO proximal tibia.
- The most proximal screw is placed just below the stifle joint but the locking hole is angled distally by 3° for the 3.5mm plate, 2.0° for the 3.5mm broad plate, 1.5° for the 2.7mm plate and 2.3° for the 2.4mm and 2.0mm plate, avoiding intra-articular placement.
- 3-4 proximal locking screws provide maximal screw security in soft cancellous bone of the tibial plateau.
- Medial buttress removal is not necessary because of the anatomic contour of the plate and locking screws proximally.
- Distal segment allows placement of:
 - two non-locking screws including one for axial compression and maximal osteotomy stability.
 - then choice of one or two locking/non-locking compression screws per plate hole.
- Full range of plate sizes.
- Fully compatible with Vi /AO style twin-start screw locking thread profile.

VILTPO15L3	Locking TPLO Plate For 1.5mm Screws 3 Holes Left
VILTPO15R3	Locking TPLO Plate For 1.5mm Screws 3 Holes Right
VILTPO20L	Locking TPLO Plate For 2.0mm Screws 3 Holes Left
VILTPO20R	Locking TPLO Plate For 2.0mm Screws 3 Holes Right
VILTPO24L	Locking TPLO Plate For 2.4mm Screws 3 Holes Left
VILTPO24R	Locking TPLO Plate For 2.4mm Screws 3 Holes Right
VILTPO27L3	Locking TPLO Plate For 2.7mm Screws 3 Holes Left
VILTPO27R3	Locking TPLO Plate For 2.7mm Screws 3 Holes Right
VILTPO35SL3	Locking TPLO Plate Small For 3.5mm Screws 3 Holes Left
VILTPO35SR3	Locking TPLO Plate Small For 3.5mm Screws 3 Holes Right
VILTPO35L3	Locking TPLO Plate For 3.5mm 3 Holes Left
VILTPO35R3	Locking TPLO Plate For 3.5mm 3 Holes Right
VILTPO35BL4	Locking TPLO Plate Broad For 3.5mm Screws 4 Holes Left
VILTPO35BR4	Locking TPLO Plate Broad For 3.5mm Screws 4 Holes Right

Vi Locking TPLO Plates



These TPLO plates are available in 2.7mm, 3.5mm and 3.5mm broad, covering the vast majority of TPLO patients.

The locking holes are both convergent and divergent to maximise pull-out resistance and angled to avoid articular surfaces.

TPLO27LPCL	TPLO Plate Locking 2.7mm Left
TPLO27LPCR	TPLO Plate Locking 2.7mm Right
TPLO35LPCL	TPLO Plate Locking 3.5mm Left
TPLO35LPCR	TPLO Plate Locking 3.5mm Right
TPLO35BLPCL	TPLO Plate Broad Locking 3.5mm Left
TPLO35BLPCR	TPLO Plate Broad Locking 3.5mm Right
TPLO35MLPCR	TPLO Narrow Head Broad Locking Plate Right 3.5mm
TPLO35MLPCL	TPLO Narrow Head Broad Locking Plate Left 3.5mm

TPLO353555 Locking Plates



Right and left pre-contoured locking versions of the original TPLO353555 clover leaf plate developed by Phil Moses (Brisbane). All the screws are set to avoid the joint space and allow for optimal load sharing. Locking holes are all stacked so will accept a cortical screw if necessary, and there are two compression holes in the plate shaft.

TPLO353555RL	3.5mm DCP 55mm Length Locking Right
TPLO353555LL	3.5mm DCP 55mm Length Locking Left

TPLO Saw Blades Vi Pattern



Vi's updated TPLO Blade has been redesigned to further reduce friction and improve cut characteristics in all sizes.

TPLOVI12	TPLO Blade Vi Pattern 12mm
TPLOVI13.5	TPLO Blade Vi Pattern 13.5mm
TPLOVI15	TPLO Blade Vi Pattern 15mm
TPLOVI18	TPLO Blade Vi Pattern 18mm
TPLOVI21	TPLO Blade Vi Pattern 21mm
TPLOVI24	TPLO Blade Vi Pattern 24mm
TPLOVI27	TPLO Blade Vi Pattern 27mm
TPLOVI30	TPLO Blade Vi Pattern 30mm
TPLOVI34	TPLO Blade Vi Pattern 34mm

TPLO Saw Blade 9mm



Vi are pleased to offer a 9mm radial cut TPLO blade by Rita Leibinger. Standard triangular mount fitting.

TPLOBLEI09	Rita Leibinger 9mm TPLO Saw Blade
-------------------	-----------------------------------

TPLO By Wedge Osteotomy

Cloverleaf Plates



- TPLO202026** 2.0mm DCP 26mm Overall Length
- TPLO202031** 2.0mm DCP 31mm Overall Length
- TPLO242434** 2.4mm DCP 34mm Overall Length
- TPLO242441** 2.4mm DCP 41mm Overall Length
- TPLO272739** 2.7mm DCP 39mm Overall Length
- TPLO272745** 2.7mm DCP 45mm Overall Length
- TPLO273539** 2.7/3.5 DCP 39mm Overall Length
Allows Use Of 3.5 Cancellous Screw In Head
- TPLO273545** 2.7mm/3.5mm DCP 45mm Overall Length 2.5mm Thick
- TPLO353555** 3.5mm DCP 55mm Overall Length
- TPLO353557** 3.5mm DCP 57mm Overall Length Heavy Duty
- TPLO353559** 3.5mm DCP 59mm Overall Length
- TPLO353562** 3.5mm DCP 62mm Overall Length
- TPLO353565** 3.5mm DCP 65mm Overall Length
- TPLO353577** 3.5mm DCP 77mm Overall Length
- TPLO353577X** 3.5mm DCP 77mm Overall Length Extra Shaft Hole
- TPLO353579** 3.5mm DCP 79mm Overall Length Heavy Duty
- TPLO354579** 3.5mm/4.5mm DCP 79mm Overall Length Heavy Duty
Allows 4.5mm Screws In Head
- TPLO35456579** 79mm Overall Length Heavy Duty
Allows 4.5mm/6.5mm Screws In Head
- TPLO45659030** 4.5mm DCP 90mm Overall Length
Will Accept 6.5mm Cancellous Screws In Head 3.0mm Thick
- TPLO45659035** 4.5mm DCP 90mm Overall Length
Will Accept 6.5mm Cancellous Screws In Head 3.5mm Thick
- TPLO45659045** 4.5mm DCP 90mm Overall Length
Will Accept 6.5mm Cancellous Screws In Head 4.5mm Thick
- TPLOO** Angle Finder & Plate Overlay

Slocum Style Plates



Slocum style TPLO plates. Not pre-contoured.

- TPLOS20L** TPLO Plate Slocum Style 2.0mm Left
- TPLOS20R** TPLO Plate Slocum Style 2.0mm Right
- TPLOS24L** TPLO Plate Slocum Style 2.4mm Left
- TPLOS24R** TPLO Plate Slocum Style 2.4mm Right
- TPLOS27L** TPLO Plate Slocum Style 2.7mm Left
- TPLOS27R** TPLO Plate Slocum Style 2.7mm Right
- TPLOS27BL** TPLO Plate Broad Slocum Style 2.7mm Left
- TPLOS27BR** TPLO Plate Broad Slocum Style 2.7mm Right
- TPLOS35L** TPLO Plate Slocum Style 3.5mm Left
- TPLOS35R** TPLO Plate Slocum Style 3.5mm Right
- TPLOS35BL** TPLO Plate Broad Slocum Style 3.5mm Left
- TPLOS35BR** TPLO Plate Broad Slocum Style 3.5mm Right

Pre-Contoured Slocum Style TPLO plates

Pre-contoured version of the standard 3.5mm Slocum Style plate. Pre-bent and polished to leave no stress riser. May need a final intra-operative tweak in some cases.

- TPLOS35RPC** 3.5mm Right Slocum Style Pre-Contoured Plate
- TPLOS35LPC** 3.5mm Left Slocum Style Pre-Contoured Plate



TPLO Instrumentation

XSTPLO Jig



Smallest TPLO Jig available from Vi. Design allows greater range of arm movement without causing intra-operative obstruction, with a single hinge to reduce bulk. Accepts 1.6mm and 2.0mm pins. 2.0mm Allen key included. Main body 60mm long.

- TPLOJIGXS.** XS TPLO Jig 60mm
- GRUBM4L4** Grub Screw M4 x 4mm

TPLO Jig

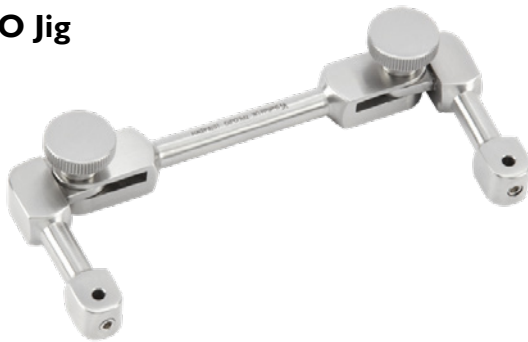

Basic TPLO jig, uses 3.2mm pins. Supplied with 2.5mm Allen key.

- TPLOJIG** TPLO Jig 120mm
- GRUBM5L5** Grub Screw M5 x 5mm

Standard Slocum Style TPLO Jig



Standard Slocum style TPLO jig. Pair of Alignment Bars and Allen key included.

Large Jig takes 3.2 pins, small Jig takes 2.4 pins. Pins not included.

- TPLOJIG/S.** Slocum Style Jig Standard (3.2mm Pin)
- TPLOJIG/SS.** Slocum Style Jig Small (2.4mm Pin)
- TPLOJIG/ROD35** Replacement Alignment Bars (Set of 2) Standard
- TPLOJIG/ROD27** Replacement Alignment Bars (Set of 2) Small
- ALLEN25** Allen Key Stainless Finish 2.5mm
- GRUBM5L5** Grub Screw M5 x 5mm

Slocum TPLO Guide Pin

End threaded negative pin. Drive directly into the tibia for jig attachment.

- TPLO32** Slocum Guide Pin 3.2mm Thread 25mm
- BCNET24** 2.4mm Bicortical Negative End Thread Pin 100mm Long

Slocum Rotation Gauges



The rotation gauges simplify the rotation procedure. The correct measurement, in millimetres, is read from the table and the appropriate gauge selected. The bone is marked using a bone scribe or an osteotome.

- 001492** Slocum Rotation Gauges

TPLO Rotation Gauge Divider Type



Alternative to the feeler gauge type measuring system. Spring loaded, adjusting the set screw fixes the points at any predetermined distance.

The tibial plateau may then be rotated the distance between the points.

- 001499** TPLO Rotation Gauge Divider Type 0-20mm
- 001499L** TPLO Rotation Gauge Divider Type Large to 40mm

TPLO Saw Blade Protractor

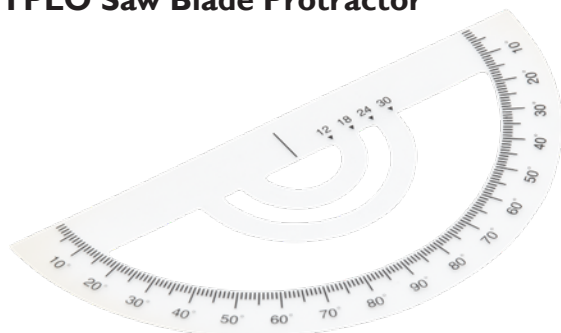

Use to accurately measure the tibial plateau slope. In addition the protractor is marked with blade outline to further assist in the planning of the TPLO procedure.

- TPLOPRO** TPLO Protractor

TPLO Rotation Chart

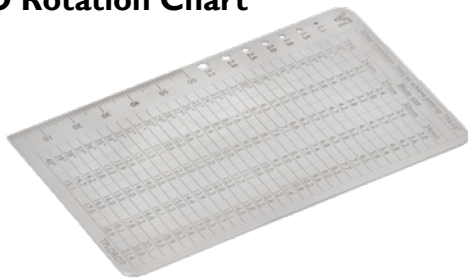

The rotation data for blades 12mm, 15mm, 18mm, 21mm, 24mm, 27mm, 30mm and 34mm are displayed on this double sided, laser marked, stainless steel gauge.

Also incorporates a drill gauge and a ruler for measuring screws and rotation.

TPLOROT TPLO Rotation Chart

Wedge Osteotomy Gauge Set 9° To 30°



Wedge gauges simplify the marking and cutting of the appropriate wedge. Using the parallel marking allows the surgeon to mark and cut a wedge with equal length borders, creating a better closure.

001493 Wedge Osteotomy Gauge Set

TPLO Reduction Forceps With Wire Guide



TPLO reduction forceps are designed to stabilise and compress across the osteotomy site. At the tip is a wire guide tube which allows a stabilising wire to be driven across the osteotomy at exactly the correct position without skidding or slippage at start up. The spin-lock allows full flexibility on positioning and compression. Available with the wire guide positioned on left or right side.

TPLORFR TPLO Reduction Forceps With Wire Guide Right
TPLORFL TPLO Reduction Forceps With Wire Guide Left
TPLORFSET TPLO Reduction Forceps With Wire Guide Set (As above)

Plate Holding/Drill Guide Forceps



Temporary fixation of the head of TPLO plates aids in positioning, while screws are placed. The spherical ball tip of these forceps seats well in the round holes of the plate, as well as in conventional DCP holes, whilst allowing drilling through the hole. Also very useful for plate osteosynthesis in fracture repair.

001225 1.5mm/2.0mm Plate Holding/Drill Guide Forceps 140mm Long
001226 2.4mm/2.7mm Plate Holding/Drill Guide Forceps 145mm Long
001227 3.5mm Plate Holding/Drill Guide Forceps 150mm Long
0012SET Plate Holding & Drill Guide Forceps Set of 3 (As above)

Very Large Fragment Forceps



Use where a wide gape is required or where the instrument needs to be further out of the surgical field. Spinlock version is very useful during CrCl surgery for repositioning the stifle prior to placement of a lateral suture, or holding osteotomies during closing wedge type procedures.

001202 Very Large Fragment Forceps 205mm Long
001203 Very Large Fragment Forceps With Spinlock 215mm Long
001203-L Very Large Fragment Forceps With Spinlock Left Handed

Extra Long Bending Levers

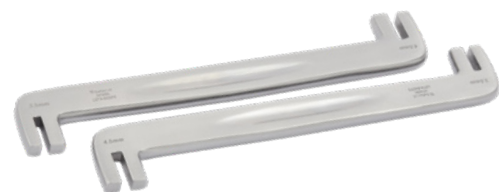

Longer plate benders (240mm) with 4mm and 6mm slots are designed with TPLO plates in mind to make bending and twisting much easier.

001288L 3.5mm/4.5mm Extra Long Bending Levers 240mm Long

LeiLOX CBLO Locking System



Combines the advantages of TPLO and TTA

CBLO (CORA Based Levelling Osteotomy) is a modern osteotomy technique to level the tibia plateau, similar to TPLO. However, CBLO addresses further challenges such as secondary (late) meniscal damage, overload of the caudal cruciate ligament, reduction of proximal anatomic axis shift and secondary translation as well as misalignment of the joint.

Multiaxial Locking and Titanium

The screws can be locked in 90° angle with a 12° deviation in any direction. This allows you to angle the screws away from vital structures. The robust star-drive screw head can be locked firmly into the plate.

All LeiLOX CBLO Implant are made of Titanium by Rita Leibinger for the best biocompatibility.

Anatomically Shaped Limited Contact Dynamic Compression Plates

The LeiLOX CBLO plates are contoured to match the anatomic shape of the bone. This makes it easier to place the plate in an optimal position.

The plate features limited contact dynamic compression to minimize vascular damage to the plated bone segment.

Double Compression

Two precisely designed compression holes enable a very tight compression of the osteotomy. This allows you to use a standard cortical screw as the cranio-caudal holding screw (instead of a headless compression screw).

Interchangeable 2.7 and 3.5mm Screws

Because the screwheads are identical, all CBLO plate sizes work with both the 2.7mm and the 3.5mm titanium CBLO screws. This offers flexibility and saves on inventory cost.

TPLO/CBLO Instrument Set

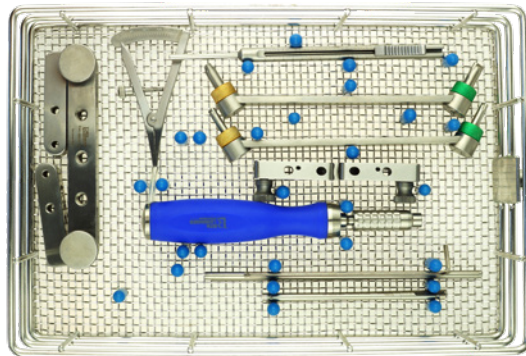

The TPLO/CBLO Instrument Set contains:

- 1x CBLO Instrument Tray
- 2x Drills (2.0 & 2.5mm)
- 3x 2 K-Wires (1.0, 2.5 & 3.0mm)
- 2x 2 Locking Drill Guides
- 2x TPLO Jigs
- 1x Screwdriver Handle
- 1x Screwdriver Shaft
- 1x Depth Gauge
- 1x Castroviejo Caliper
- 2x Compression Drill Guides

CBLO142010001 TPLO/CBLO Instrument Set

CBLO Plates



Titanium. Featuring both locking and compression screw holes.

CBLOI42232710	LeiLOX CBLO Locking Plate Broad 2.7mm Left 55mm
CBLOI42232700	LeiLOX CBLO Locking Plate Broad 2.7mm Right 55mm
CBLOI42233510	LeiLOX CBLO Locking Plate Broad 3.5mm Left 70mm
CBLOI42233500	LeiLOX CBLO Locking Plate Broad 3.5mm Right 70mm
CBLOI42233560	LeiLOX CBLO Locking Plate Broad 3.5mm Left 78mm
CBLOI42233550	LeiLOX CBLO Locking Plate Broad 3.5mm Right 78mm

LeiLox Locking Cortical Screws 2.7mm



For LeiLOX Locking System, Star Drive T10 self-holding (T10 Shaft from Rita Leibinger needed). Self-tapping with three flute cutting edge.

LEILOXL27STAR16	2.7mm Leilox Titanium Locking Screw 16mm
LEILOXL27STAR18	2.7mm Leilox Titanium Locking Screw 18mm
LEILOXL27STAR20	2.7mm Leilox Titanium Locking Screw 20mm
LEILOXL27STAR22	2.7mm Leilox Titanium Locking Screw 22mm
LEILOXL27STAR24	2.7mm Leilox Titanium Locking Screw 24mm
LEILOXL27STAR26	2.7mm Leilox Titanium Locking Screw 26mm
LEILOXL27STAR28	2.7mm Leilox Titanium Locking Screw 28mm
LEILOXL27STAR30	2.7mm Leilox Titanium Locking Screw 30mm
LEILOXL27STAR32	2.7mm Leilox Titanium Locking Screw 32mm
LEILOXL27STAR34	2.7mm Leilox Titanium Locking Screw 34mm
LEILOXL27STAR36	2.7mm Leilox Titanium Locking Screw 36mm
LEILOXL27STAR38	2.7mm Leilox Titanium Locking Screw 38mm
LEILOXL27STAR40	2.7mm Leilox Titanium Locking Screw 40mm
LEILOXL27STAR42	2.7mm Leilox Titanium Locking Screw 42mm
LEILOXL27STAR44	2.7mm Leilox Titanium Locking Screw 44mm
LEILOXL27STAR46	2.7mm Leilox Titanium Locking Screw 46mm

LeiLox Non Locking Cortical Screws 2.7mm



Star Drive T10. Self-holding (T10 Shaft from Rita Leibinger needed). Self-tapping with three flute cutting edge.

LEIOXNL27STAR16	2.7mm Leilox Titanium Non Locking Screw 16mm
LEIOXNL27STAR18	2.7mm Leilox Titanium Non Locking Screw 18mm
LEIOXNL27STAR20	2.7mm Leilox Titanium Non Locking Screw 20mm
LEIOXNL27STAR22	2.7mm Leilox Titanium Non Locking Screw 22mm
LEIOXNL27STAR24	2.7mm Leilox Titanium Non Locking Screw 24mm
LEIOXNL27STAR26	2.7mm Leilox Titanium Non Locking Screw 26mm
LEIOXNL27STAR28	2.7mm Leilox Titanium Non Locking Screw 28mm
LEIOXNL27STAR30	2.7mm Leilox Titanium Non Locking Screw 30mm
LEIOXNL27STAR32	2.7mm Leilox Titanium Non Locking Screw 32mm
LEIOXNL27STAR34	2.7mm Leilox Titanium Non Locking Screw 34mm

LeiLox Locking Cortical Screws 3.5mm



For LeiLOX Locking System, Star Drive T10 self-holding (T10 Shaft from Rita Leibinger needed). Self-tapping with three flute cutting edge.

LEILOXL35STAR16	3.5mm Leilox Titanium Locking Screw 16mm
LEILOXL35STAR18	3.5mm Leilox Titanium Locking Screw 18mm
LEILOXL35STAR20	3.5mm Leilox Titanium Locking Screw 20mm
LEILOXL35STAR22	3.5mm Leilox Titanium Locking Screw 22mm
LEILOXL35STAR24	3.5mm Leilox Titanium Locking Screw 24mm
LEILOXL35STAR26	3.5mm Leilox Titanium Locking Screw 26mm
LEILOXL35STAR28	3.5mm Leilox Titanium Locking Screw 28mm
LEILOXL35STAR30	3.5mm Leilox Titanium Locking Screw 30mm
LEILOXL35STAR32	3.5mm Leilox Titanium Locking Screw 32mm
LEILOXL35STAR34	3.5mm Leilox Titanium Locking Screw 34mm
LEILOXL35STAR36	3.5mm Leilox Titanium Locking Screw 36mm
LEILOXL35STAR38	3.5mm Leilox Titanium Locking Screw 38mm
LEILOXL35STAR40	3.5mm Leilox Titanium Locking Screw 40mm
LEILOXL35STAR42	3.5mm Leilox Titanium Locking Screw 42mm
LEILOXL35STAR44	3.5mm Leilox Titanium Locking Screw 44mm
LEILOXL35STAR46	3.5mm Leilox Titanium Locking Screw 46mm
LEILOXL35STAR48	3.5mm Leilox Titanium Locking Screw 48mm
LEILOXL35STAR50	3.5mm Leilox Titanium Locking Screw 50mm
LEILOXL35STAR52	3.5mm Leilox Titanium Locking Screw 52mm
LEILOXL35STAR54	3.5mm Leilox Titanium Locking Screw 54mm
LEILOXL35STAR56	3.5mm Leilox Titanium Locking Screw 56mm
LEILOXL35STAR58	3.5mm Leilox Titanium Locking Screw 58mm
LEILOXL35STAR60	3.5mm Leilox Titanium Locking Screw 60mm

LeiLox Non Locking Cortical Screws 3.5mm



Star Drive T10. Self-holding (T10 Shaft from Rita Leibinger needed). Self-tapping with three flute cutting edge.

LEIOXNL35STAR16	3.5mm Leilox Titanium Non Locking Screw 16mm
LEIOXNL35STAR18	3.5mm Leilox Titanium Non Locking Screw 18mm
LEIOXNL35STAR20	3.5mm Leilox Titanium Non Locking Screw 20mm
LEIOXNL35STAR22	3.5mm Leilox Titanium Non Locking Screw 22mm
LEIOXNL35STAR24	3.5mm Leilox Titanium Non Locking Screw 24mm
LEIOXNL35STAR26	3.5mm Leilox Titanium Non Locking Screw 26mm
LEIOXNL35STAR28	3.5mm Leilox Titanium Non Locking Screw 28mm
LEIOXNL35STAR30	3.5mm Leilox Titanium Non Locking Screw 30mm
LEIOXNL35STAR32	3.5mm Leilox Titanium Non Locking Screw 32mm
LEIOXNL35STAR34	3.5mm Leilox Titanium Non Locking Screw 34mm

Screwdriver Shaft Star Drive T10



Self holding.

TTARI28273510 Star-Drive Screwdriver Shaft T10 For 2.7/3.5mm Screws

Screwdriver Handle - Silicone



Silicone. Sterilisable up to 134°C.

TTAR247010200	Standard Screwdriver Handle AO Connection for 2.7/3.5 Screws
LEIOXI64-2700-00	Leilox Locking Drill Guide For 2.7mm Screws
LEIOXI64-3500-00	Leilox Locking Drill Guide For 3.5mm Screws

Tibial Tuberosity Advancement (TTA)

To view our Surgery Guide on TTA, please scan the QR code below.



The TTA procedure developed by Tepic and Montavon is designed to bring the tibial plateau to sit at 90° to the straight patella ligament. This effectively neutralises the shear forces within the stifle under loading, making the stifle stable.

This is achieved by advancing the tibial tuberosity and stabilising the created defect using a titanium cage and plate. The cage is selected for both thickness and width. The implants are secured using titanium screws.

Titanium is very osteoconductive resulting in rapid healing. The use of stainless steel implants is not recommended.

Premium TTA Case



Storage and autoclave case for TTA equipment and implants.

TTABOX Premium TTA Case (Box & Insert only)

TTA Starter Kit with Forkless Plates



An alternative to the traditional forked plates. Secured using 2.4mm screws in the tibial crest, after the osteotomy and advancement have been made. Distal plate holes are secured using screws as appropriate. The rest of the technique is as per standard TTA.

Advantages:

- Position of the plate on the tibial crest and tibial diaphysis not fixed until after the osteotomy and advancement have been made – avoids difficult diaphyseal screw placement where the distal screws are too caudal on the tibia. Problem in small breeds and if this is missed in planning
- Tibial crest screws can be angled if needed
- Screw length of tibial crest screws can be individually selected for better fit
- Fewer screw holes in tibial crest than fork holes, helping reduce risk of tibial crest fracture

Full kit list is available upon request.

TTAFLPREM TTA Forkless Starter Kit

TTA Starter Kit



Full kit list is available upon request.

TTAPREM TTA Starter Kit in a Premium Aluminium Box

TTA Implants

TTA Cages



All cage sizes are secured using 2.4mm titanium screws.

- TTAC310** Titanium TTA Cage 3 x 10mm
- TTAC313** Titanium TTA Cage 3 x 13mm
- TTAC316** Titanium TTA Cage 3 x 16mm
- TTAC4512** Titanium TTA Cage 4.5 x 12mm
- TTAC4515** Titanium TTA Cage 4.5 x 15mm
- TTAC4518** Titanium TTA Cage 4.5 x 18mm
- TTAC616** Titanium TTA Cage 6 x 16mm
- TTAC619** Titanium TTA Cage 6 x 19mm
- TTAC622** Titanium TTA Cage 6 x 22mm
- TTAC7513** Titanium TTA Cage 7.5 x 13mm
- TTAC7516** Titanium TTA Cage 7.5 x 16mm
- TTAC7519** Titanium TTA Cage 7.5 x 19mm
- TTAC919** Titanium TTA Cage 9 x 19mm
- TTAC922** Titanium TTA Cage 9 x 22mm
- TTAC925** Titanium TTA Cage 9 x 25mm
- TTAC10519** Titanium TTA Cage 10.5 x 19mm
- TTAC10522** Titanium TTA Cage 10.5 x 22mm
- TTAC10525** Titanium TTA Cage 10.5 x 25mm
- TTAC1222** Titanium TTA Cage 12 x 22mm
- TTAC1225** Titanium TTA Cage 12 x 25mm
- TTAC1228** Titanium TTA Cage 12 x 28mm
- TTAC13522** Titanium TTA Cage 13.5 x 22mm
- TTAC13525** Titanium TTA Cage 13.5 x 25mm
- TTAC13528** Titanium TTA Cage 13.5 x 28mm
- TTAC1522** Titanium TTA Cage 15 x 22mm
- TTAC1525** Titanium TTA Cage 15 x 25mm
- TTAC1528** Titanium TTA Cage 15 x 28mm
- TTAC1531** Titanium TTA Cage 15 x 31mm

TTA Cuttable Cages



Cuttable cages can be trimmed in 3mm increments, to cover a larger range of patients with a reduced inventory.

- TTACUT316** Cuttable Cage 3 x 16mm
- TTACUT4518** Cuttable Cage 4.5 x 18mm
- TTACUT622** Cuttable Cage 6 x 22mm
- TTACUT7522** Cuttable Cage 7.5 x 22mm
- TTACUT926** Cuttable Cage 9 x 26mm
- TTACUT10526** Cuttable Cage 10.5 x 26mm
- TTACUT1228** Cuttable Cage 12 x 28mm
- TTACUT13528** Cuttable Cage 13.5 x 28mm
- TTACUT1532** Cuttable Cage 15 x 32mm
- TTACUTI** Cuttable Cage Set (9) With Free Cage Cutters
- TTACACUT** TTA Cuttable Cage Cutter

TTA Plates



- TTAP2** Titanium TTA Plate 2 Hole
- TTAP3** Titanium TTA Plate 3 Hole
- TTAP4** Titanium TTA Plate 4 Hole
- TTAP5** Titanium TTA Plate 5 Hole
- TTAP6** Titanium TTA Plate 6 Hole
- TTAP7** Titanium TTA Plate 7 Hole
- TTAP8** Titanium TTA Plate 8 Hole

TTA Forks

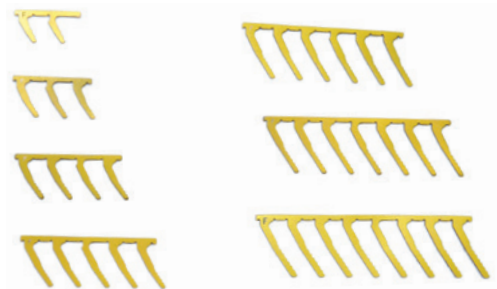

- TTAF2** Titanium TTA Fork 2 Prong
- TTAF3** Titanium TTA Fork 3 Prong
- TTAF4** Titanium TTA Fork 4 Prong
- TTAF5** Titanium TTA Fork 5 Prong
- TTAF6** Titanium TTA Fork 6 Prong
- TTAF7** Titanium TTA Fork 7 Prong
- TTAF8** Titanium TTA Fork 8 Prong

Forkless TTA Plates

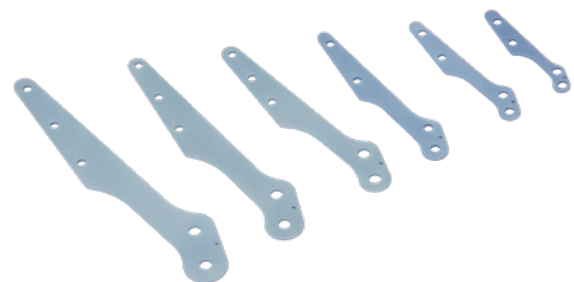

- TTAX42** Forkless TTA Plate (Same Length as TTAP3) 2.4+2.7 Screw
- TTAX52** Forkless TTA Plate (Same Length as TTAP4) 2.4+2.7 Screw
- TTAX65** Forkless TTA Plate (Same Length as TTAP5) 2.7 Screw
- TTAX78** Forkless TTA Plate (Same Length as TTAP6) 2.7+3.5 Screw
- TTAX91** Forkless TTA Plate (Same Length as TTAP7) 3.5 Screw
- TTAX104** Forkless TTA Plate (Same Length as TTAP8) 3.5 Screw
- TTAXSET** Forkless TTA Plate Set - One of Each Size

Titanium Screws

2.4mm Titanium Screws - Cruciate Head

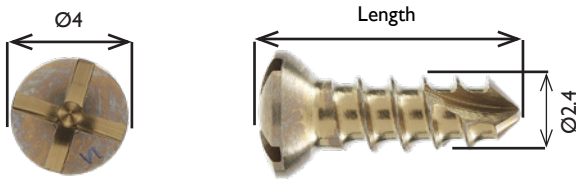

Pilot Drill - 1.8mm

TICS2408	Titanium 2.4mm Self Tapping Cortical Screw 8mm
TICS2410	Titanium 2.4mm Self Tapping Cortical Screw 10mm
TICS2412	Titanium 2.4mm Self Tapping Cortical Screw 12mm
TICS2414	Titanium 2.4mm Self Tapping Cortical Screw 14mm
TICS2416	Titanium 2.4mm Self Tapping Cortical Screw 16mm
TICS2418	Titanium 2.4mm Self Tapping Cortical Screw 18mm
TICS2420	Titanium 2.4mm Self Tapping Cortical Screw 20mm
TICS2422	Titanium 2.4mm Self Tapping Cortical Screw 22mm
TICS2424	Titanium 2.4mm Self Tapping Cortical Screw 24mm
TICS2426	Titanium 2.4mm Self Tapping Cortical Screw 26mm
TICS2428	Titanium 2.4mm Self Tapping Cortical Screw 28mm
TICS2430	Titanium 2.4mm Self Tapping Cortical Screw 30mm
TICS2432	Titanium 2.4mm Self Tapping Cortical Screw 32mm
TICS2434	Titanium 2.4mm Self Tapping Cortical Screw 34mm
TICS2436	Titanium 2.4mm Self Tapping Cortical Screw 36mm
TICS2438	Titanium 2.4mm Self Tapping Cortical Screw 38mm
TICS2440	Titanium 2.4mm Self Tapping Cortical Screw 40mm

2.7mm Titanium Screws - Hexagonal Head

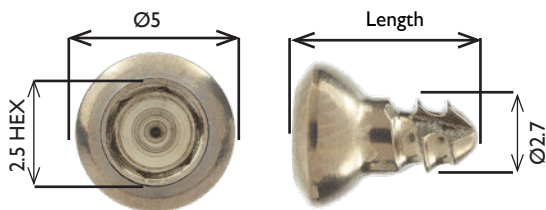

Pilot Drill - 2.0mm

TICS2706	Titanium 2.7mm Self Tapping Cortical Screw 6mm
TICS2708	Titanium 2.7mm Self Tapping Cortical Screw 8mm
TICS2710	Titanium 2.7mm Self Tapping Cortical Screw 10mm
TICS2712	Titanium 2.7mm Self Tapping Cortical Screw 12mm
TICS2714	Titanium 2.7mm Self Tapping Cortical Screw 14mm
TICS2716	Titanium 2.7mm Self Tapping Cortical Screw 16mm
TICS2718	Titanium 2.7mm Self Tapping Cortical Screw 18mm
TICS2720	Titanium 2.7mm Self Tapping Cortical Screw 20mm
TICS2722	Titanium 2.7mm Self Tapping Cortical Screw 22mm
TICS2724	Titanium 2.7mm Self Tapping Cortical Screw 24mm
TICS2726	Titanium 2.7mm Self Tapping Cortical Screw 26mm
TICS2728	Titanium 2.7mm Self Tapping Cortical Screw 28mm
TICS2730	Titanium 2.7mm Self Tapping Cortical Screw 30mm
TICS2732	Titanium 2.7mm Self Tapping Cortical Screw 32mm
TICS2734	Titanium 2.7mm Self Tapping Cortical Screw 34mm
TICS2736	Titanium 2.7mm Self Tapping Cortical Screw 36mm
TICS2738	Titanium 2.7mm Self Tapping Cortical Screw 38mm
TICS2740	Titanium 2.7mm Self Tapping Cortical Screw 40mm

3.5mm Titanium Screws - Hexagonal Head

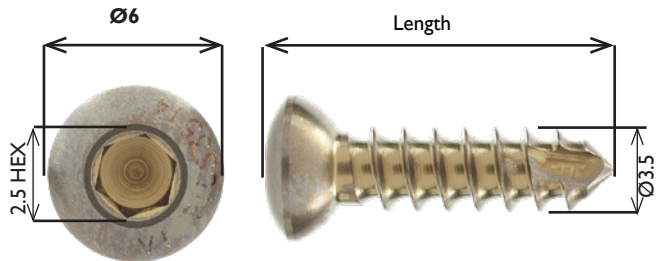

Pilot Drill - 2.5mm

TICS3514	Titanium 3.5mm Self Tapping Cortical Screw 14mm
TICS3516	Titanium 3.5mm Self Tapping Cortical Screw 16mm
TICS3518	Titanium 3.5mm Self Tapping Cortical Screw 18mm
TICS3520	Titanium 3.5mm Self Tapping Cortical Screw 20mm
TICS3522	Titanium 3.5mm Self Tapping Cortical Screw 22mm
TICS3524	Titanium 3.5mm Self Tapping Cortical Screw 24mm
TICS3526	Titanium 3.5mm Self Tapping Cortical Screw 26mm
TICS3528	Titanium 3.5mm Self Tapping Cortical Screw 28mm
TICS3530	Titanium 3.5mm Self Tapping Cortical Screw 30mm
TICS3532	Titanium 3.5mm Self Tapping Cortical Screw 32mm
TICS3534	Titanium 3.5mm Self Tapping Cortical Screw 34mm
TICS3536	Titanium 3.5mm Self Tapping Cortical Screw 36mm
TICS3538	Titanium 3.5mm Self Tapping Cortical Screw 38mm
TICS3540	Titanium 3.5mm Self Tapping Cortical Screw 40mm

Screwbox For Titanium TTA Screws



SHTTA242735 TTA Screwbox For 2.4mm, 2.7mm & 3.5mm Titanium Screws

Drill Bits - Standard Length - Round Shank

	Diameter	Overall length	Flute length
H090208	1.8mm	110mm	25mm
H090102	2.0mm	110mm	30mm
H090112	2.5mm	120mm	30mm

TTA Washers



Stackable titanium washers. Permit adjustments in 1mm increments.

PW24TI 2.4mm TTA Washer - Titanium

TTA Spacers



Placed under either cranial or caudal cage lugs to help re-align the quadriceps mechanism in cases of concurrent patellar luxation while performing the TTA procedure. Suggested maximum tibial tuberosity movement is 50%.

TTASP2	TTA Spacer Titanium 2mm
TTASP4	TTA Spacer Titanium 4mm
TTASP6	TTA Spacer Titanium 6mm
TTASP8	TTA Spacer Titanium 8mm

TTA Instrumentation



The TTA procedure does require some essential instruments. Positioning of the fork and cage is impossible without the following instruments.

TTA554	TTA Drill Guide (4 Hole)
TTA555	TTA Drill Guide (8 Hole)
TTA666	TTA Fork Holder
TTA444	TTA Spreader & 3mm, 6mm, 9mm, 12mm & 15mm Inserts
TTA333	TTA Plate Bender
TTA777	1.9mm Pins (Set of Two)
TTAPFO	TTA Plate & Fork Overlay
TTATAN	Common Tangent TTA/MMT Advancement Overlay
DG242735	Depth Gauge for 2.4/ 2.7 /3.5mm Screws

TTA Cage Forceps



Manipulating the TTA cage into the correct position can be an awkward part of the procedure, particularly the smaller sizes.

The TTA cage forceps grasp the cage firmly along the spine allowing it to be extracted from the case and placed into the tibial crest osteotomy.

TTAFCP TTA Cage Forceps

Forkless Plate Forceps



Holds the plate in position allowing the pilot hole to be drilled through the guide in the correct position, even after the osteotomy has been made.

TTAXFCP Forkless TTA Plate Forceps (145mm)

TTA Cuttable Cage Cutters



TTA cage cutters, which have narrow jaws designed to fit between the fins of cuttable cages. These cutters are only for TTA cages – not suitable for other implants due to the specially designed slim jaws.

TTACACUT TTA Cuttable Cage Cutter

TTA Mallet



The TTA Fork needs to be gently tapped home for maximum stability. The 140 gram Mallet is the ideal weight.

001323 Mallet 140g 155mm Long

TTA Spinlock Reduction Forceps



Increasing repair stability and reducing healing times can be achieved by compression of the distal tibial tubercle to the tibial shaft.

The spinlock reduction forceps are the right size and have the correct degree of spread for most TTA procedures.

001245SL TTA Spinlock Reduction Forceps 180mm

TTA Saw Guide



The TTA saw guide is useful where the surgeon would prefer to use a guide which can be positioned correctly to maintain the position and plane of the cut, allowing concentration on the saw. Secured in place with standard fragment forceps, the guide is removed for the final freehand curve at the distal end of the osteotomy.

Suitable for both right and left leg.

TTA999 TTA Saw Guide

TTA Rapid

TTA Rapid Starter Kit

Instrument and selected implant set, supplied in basket-type containers with dedicated racks. Implant set contains commonly used sizes as listed below.



TTA Rapid Starter Kit contains:

TTARNEWPREMINST contents as listed below, plus:

Implant Tray containing

6mm x 16mm Cage x1	10.5mm x 22mm Cage x1
7.5mm x 16mm Cage x1	10.5mm x 25mm Cage x1
7.5mm x 19mm Cage x1	12mm x 22mm Cage x1 (8 cages in total)
9mm x 19mm Cage x1	
9mm x 22mm Cage x1	

Screws

1x 8mm	4x 22mm	2x 34mm
2x 10mm	4x 24mm	2x 36mm
4x 12mm	4x 26mm	2x 38mm
4x 14mm	4x 28mm	1x 40mm
4x 16mm	4x 30mm	(54 Screws in total)
4x 20mm	4x 32mm	

2x 2.5ml Nanopaste

TTARNEWSTARTKIT TTA Rapid Starter Kit

TTA Rapid Premium Instrument Kit

Premium instruments kit contains:

TTAR132400013	TTA Rapid Lever-Spreader Double Ended 4mm & 6mm Broad	x1
TTAR132401013	TTA Rapid Lever-Spreader Double Ended 9mm & 12mm Broad	x1
TTAR132402000	TTA Rapid Bending Iron, Double Ended	x1
TTAR144102510	TTA Rapid K Wire Single Trochar Tip 2.5mm x 100mm	x1
TTAR148008018	TTA Rapid 1.8mm Drill Bit Round Shaft	x1
TTAR164005016	TTA Rapid Plate Holding Forceps 16cm Angled	x1
TTAR164273560	TTA Rapid Depth Gauge 150mm 60mm	x1
TTAR20342420	TTA Rapid Screwdriver Shaft for 2.4 Hex 100mm AO Fitting	x1
TTAR20346424	TTA Rapid Holding Sleeve for 2.4mm Hex Screws	x1
TTAR247010300	2mm TTA Rapid Screwdriver Handle AO Coupling	x1
TTAR164007018	TTA Rapid 1.5/1.8 Sleeve/Guide for 2.0mm & 2.4mm Screws	x1
TTAR132500010/A	TTA Rapid Wire Box for Instruments	x1
TTAR13240400	TTA Rapid L Shape Saw Guide With Pin	x1
TTAR132404100	TTA Rapid Petite Saw Guide With Guide Pin	x1

TTARNEWPREMINST TTA Rapid Premium Instrument Kit

TTA Rapid Tray with Lid

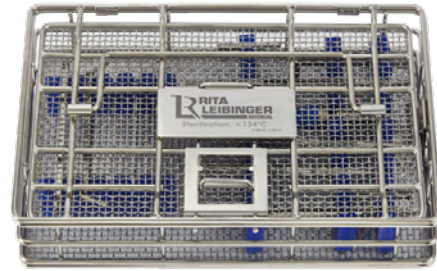

TTAR132500000/A

TTA Rapid Implant Tray Supplied Empty

TTAR132500010/A

TTA Rapid Instrument Tray Supplied Empty.

TTA Rapid Screw Rack



TTA rapid screw rack supplied empty, available in 2 sizes.

TTAR2103624

TTA Rapid Screw Rack - Standard For 2.4mm Screws For 6 - 40mm in Length

TTAR1500520

TTA Rapid Screw Rack - 'Petite' For 2.0mm Screws For 6mm to 20mm in Length

TTA Rapid Accessories

TTAR144101010	TTA Rapid K Wire Single Trochar Tip 1.2mm x 100mm
TTAR144101510	TTA Rapid K Wire Single Trochar Tip 1.5mm x 100mm
TTAR144102510	TTA Rapid K Wire Single Trochar Tip 2.5mm x 100mm
TTAR148008018	TTA Rapid 1.8mm Twist Drill Bit Round Shaft
TTAR148008020	TTA Rapid 2.0mm Drill Bit Round Shaft
TTAR148008030	TTA Rapid 3.0mm Drill Bit Round Shaft
TTAR148008118	TTA Rapid Twist Drill 1.8mm 125/ 25mm AO Shaft
TTAR148008120	TTA Rapid Twist Drill 2.0mm AO Shaft
TTAR148012030	TTA Rapid Twist Drill 3.0mm 110/ 85mm AO Shaft

TTA Rapid - Implants TTA Rapid Cages - Standard



For use with 2.4mm TTA Rapid Screws.

- TTAR38** TTA Rapid Cage 3/8 Titanium
- TTAR310** TTA Rapid Cage 3/10 Titanium
- TTAR313** TTA Rapid Cage 3/13 Titanium
- TTAR316** TTA Rapid Cage 3/16 Titanium
- TTAR459** TTA Rapid Cage 4.5/9 Titanium
- TTAR4512** TTA Rapid Cage 4.5/12 Titanium
- TTAR4515** TTA Rapid Cage 4.5/15 Titanium
- TTAR4518** TTA Rapid Cage 4.5/18 Titanium
- TTAR613** TTA Rapid Cage 6/13 Titanium
- TTAR616** TTA Rapid Cage 6/16 Titanium
- TTAR619** TTA Rapid Cage 6/19 Titanium
- TTAR622** TTA Rapid Cage 6/22 Titanium
- TTAR7513** TTA Rapid Cage 7.5/13 Titanium
- TTAR7516** TTA Rapid Cage 7.5/16 Titanium
- TTAR7519** TTA Rapid Cage 7.5/19 Titanium
- TTAR7522** TTA Rapid Cage 7.5/22 Titanium
- TTAR916** TTA Rapid Cage 9/16 Titanium
- TTAR919** TTA Rapid Cage 9/19 Titanium
- TTAR922** TTA Rapid Cage 9/22 Titanium
- TTAR925** TTA Rapid Cage 9/25 Titanium
- TTARI0516** TTA Rapid Cage 10.5/16 Titanium
- TTARI0519** TTA Rapid Cage 10.5/19 Titanium
- TTARI0522** TTA Rapid Cage 10.5/22 Titanium
- TTARI0525** TTA Rapid Cage 10.5/25 Titanium
- TTARI219** TTA Rapid Cage 12/19 Titanium
- TTARI222** TTA Rapid Cage 12/22 Titanium
- TTARI225** TTA Rapid Cage 12/25 Titanium
- TTARI228** TTA Rapid Cage 12/28 Titanium
- TTARI3519** TTA Rapid Cage 13.5/19 Titanium
- TTARI3522** TTA Rapid Cage 13.5/22 Titanium
- TTARI3525** TTA Rapid Cage 13.5/25 Titanium
- TTARI3528** TTA Rapid Cage 13.5/28 Titanium
- TTARI519** TTA Rapid Cage 15/19 Titanium
- TTARI522** TTA Rapid Cage 15/22 Titanium
- TTARI525** TTA Rapid Cage 15/25 Titanium
- TTARI528** TTA Rapid Cage 15/28 Titanium

TTA Rapid Acetate

- TTARACE** TTA Rapid Acetate

TTA Rapid 2.4mm Titanium Screws - 2.0mm Hex Head

Pilot drill - 1.8mm



- TTARSC2406** TTA Rapid 2.4mm Screw Titanium 6mm
- TTARSC2408** TTA Rapid 2.4mm Screw Titanium 8mm
- TTARSC2410** TTA Rapid 2.4mm Screw Titanium 10mm
- TTARSC2412** TTA Rapid 2.4mm Screw Titanium 12mm
- TTARSC2414** TTA Rapid 2.4mm Screw Titanium 14mm
- TTARSC2416** TTA Rapid 2.4mm Screw Titanium 16mm
- TTARSC2418** TTA Rapid 2.4mm Screw Titanium 18mm
- TTARSC2420** TTA Rapid 2.4mm Screw Titanium 20mm
- TTARSC2422** TTA Rapid 2.4mm Screw Titanium 22mm
- TTARSC2424** TTA Rapid 2.4mm Screw Titanium 24mm
- TTARSC2426** TTA Rapid 2.4mm Screw Titanium 26mm
- TTARSC2428** TTA Rapid 2.4mm Screw Titanium 28mm
- TTARSC2430** TTA Rapid 2.4mm Screw Titanium 30mm
- TTARSC2432** TTA Rapid 2.4mm Screw Titanium 32mm
- TTARSC2434** TTA Rapid 2.4mm Screw Titanium 34mm
- TTARSC2436** TTA Rapid 2.4mm Screw Titanium 36mm
- TTARSC2438** TTA Rapid 2.4mm Screw Titanium 38mm
- TTARSC2440** TTA Rapid 2.4mm Screw Titanium 40mm

TTA Rapid - Instrumentation

TTA Rapid Bending Iron



This is used for contouring the cage ears for accurate placement and is common to the original and modified techniques. The use of other devices to create this contour is likely to result in damage to the cage ears.

- TTARI32402000** TTA Rapid Bending Iron

TTA Rapid L-Shaped Guide



L-Shaped saw guide for the TTA Rapid technique.

- TTARI32404000.** TTA Rapid L-Shaped Saw Guide With Pin
- TTARI32403010** TTA Rapid Saw Guide Pin

TTA Rapid Lever Spreader



These are used to open the osteotomy incrementally to the required width. The spreaders measure 1mm wider than their stated size to permit insertion of a cage beneath them.

- TTARI32400013 TTA Rapid Lever Spreader Double-Ended 3mm & 9mm Broad
- TTARI32401013 TTA Rapid Lever Spreader Double-Ended 6mm & 12mm Broad
- TTARI32401513 TTA Rapid Lever Spreader Double-Ended 13.5mm & 15mm Broad

TTA Rapid Universal Spreader



Permits incremental opening of the osteotomy in a very controlled manner. 160mm length.

- TTARI32408016 TTA Rapid Universal Spreader

TTA Rapid Screwdriver Handle



- TTAR247010300 2mm TTA Rapid Screwdriver Handle AO Coupling

TTA Rapid Screwdriver Inserts



- TTAR20342420 TTA Rapid Screwdriver Insert For 2.4mm Hex Screws AO Fitting 100mm Long
- TTAR20346424 TTA Rapid Screw Holding Sleeve For 2.4mm Hex Screws

TTA Rapid Plate Holding Forceps - Angled



Used to remove cages from implant trays.

- TTARI64005016 Plate Holding Forceps - Angled - 160mm Long

TTA Rapid Depth Gauge



- TTARI64273560 Depth Gauge For 2.4mm Screws 150mm Long - Reads To 40mm

TTA Rapid Drill Sleeve Guide For 2.4mm Screws



Used for accurate positioning of pilot holes for 2.4mm screws.

- TTARI64007018 TTA Rapid 1.5/1.8 Sleeve/Guide for 2.0mm & 2.4mm Screws

Reduction Forceps With Spinlock



- 001203 Very Large Fragment Forceps With Spinlock 215mm Long
- 001245SL Large Fragment Forceps With Spinlock 180mm Long

Plate Holding/Drill Guide Forceps



Used to snug the TTA Rapid cage ears against the medial cortex prior to drilling pilot holes.

- 001225 1.5mm/2.0mm Plate Holding/Drill Guide Forceps 140mm Long
- 001226 2.4mm/2.7mm Plate Holding/Drill Guide Forceps 145mm Long

TTA Rapid Petite

Petite uses 2mm screws, and has dedicated instrumentation including saw guide. Petite is designed for smaller patients such as cats and smaller dogs, where 3mm advancement is sufficient but 2.4mm screws in the tibial tubercle are not appropriate.



TTA Rapid Cages - Petite

For use with 2.0mm TTA Rapid Screws.

- TTARI32002308** TTA Rapid Cage Titanium 3/08
- TTARI32002310** TTA Rapid Cage Titanium 3/10
- TTARI32002313** TTA Rapid Cage Titanium 3/13

TTA Rapid Screws 2.0mm Titanium - Hex Head

Pilot drill - 1.5mm

- TTARSC2006** TTA Rapid 2.0mm Screw Titanium 6mm
- TTARSC2008** TTA Rapid 2.0mm Screw Titanium 8mm
- TTARSC2010** TTA Rapid 2.0mm Screw Titanium 10mm
- TTARSC2012** TTA Rapid 2.0mm Screw Titanium 12mm
- TTARSC2014** TTA Rapid 2.0mm Screw Titanium 14mm
- TTARSC2016** TTA Rapid 2.0mm Screw Titanium 16mm
- TTARSC2018** TTA Rapid 2.0mm Screw Titanium 18mm
- TTARSC2020** TTA Rapid 2.0mm Screw Titanium 20mm
- TTARSC2022** TTA Rapid 2.0mm Screw Titanium 22mm
- TTARSC2024** TTA Rapid 2.0mm Screw Titanium 24mm
- TTARSC2026** TTA Rapid 2.0mm Screw Titanium 26mm
- TTARSC2028** TTA Rapid 2.0mm Screw Titanium 28mm
- TTARSC2030** TTA Rapid 2.0mm Screw Titanium 30mm

TTA Rapid Petite Screwdriver Insert & Sleeve



TTAR20DRIVER TTA Rapid 2.0mm Screwdriver, Insert & Sleeve

TTA Rapid Petite Depth Gauge



TTARI64152020 TTA Rapid Petite Depth Gauge For 2.0mm Screws

TTA Rapid L-Shaped Petite Saw Guide



This guide is used for cage sizes 3 - 4.5mm.

TTARI32404100. TTA Rapid L-Shaped Petite Saw Guide With Pin

TTA Rapid Petite Twist Drill

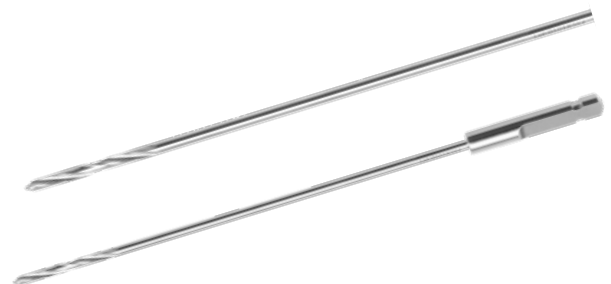

- TTARI48008015** TTA Rapid Twist Drill Bit 1.5mm Round Shaft
- TTARI48008115** TTA Rapid Twist Drill Bit 1.5mm AO Shaft

Tiny TTAR Spreader

TTARI32-4080-08 Tiny TTAR Spreader

Tiny TTA Rapid

Tiny TTA Rapid is designed for tiny animals – especially cats, toy dogs and dogs with short legs needing a wide advancement. The Tiny sawguide allows short osteotomies.

Tiny TTA Rapid Set



The Tiny TTA Rapid Set contains:

- 1 Sterilisation Tray with Lid
- 1 of each Tiny TTA Rapid Cage (12 total)
- 1 of each 2, 3 & 4mm Patella Spacer (6 total)
- 1 Rapid Luxation Plate Petite
- 5 of each 1.5mm Screw (6-20mm 40 total)
- 5 of each 2.0mm Screw (6-26mm 55 total)
- 1 Tibia Tappet Petite
- 1 Plate Holding Forceps
- 1 Tiny Sawguide with Pin & K-Wire
- 1 Depth Gauge
- 2 Drills (1.1 & 1.5mm)
- 2 Screwdriver Shafts (T6 & T8)
- 1 Screwdriver Handle
- 1 Drill Guide

TTARI32650000 Tiny TTA Rapid Set

Tiny TTA Rapid Cages

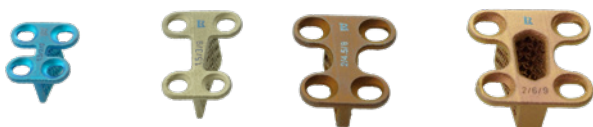

2.0mm cages use 1.5mm screws. 3.0mm cages use 1.5 or 2.0mm screws. 4.5 and 6mm cages use 2.0mm screws.

- TTAR2/6** Tiny TTA Rapid Cage 2/6 Titanium
- TTAR2/8** Tiny TTA Rapid Cage 2/8 Titanium
- TTAR2/10** Tiny TTA Rapid Cage 2/10 Titanium
- TTAR3/7** Tiny TTA Rapid Cage 3/7 Titanium
- TTAR3/9** Tiny TTA Rapid Cage 3/9 Titanium
- TTAR3/11** Tiny TTA Rapid Cage 3/11 Titanium
- TTAR4/8** Tiny TTA Rapid Cage 4/8 Titanium
- TTAR4/10** Tiny TTA Rapid Cage 4/10 Titanium
- TTAR4/12** Tiny TTA Rapid Cage 4/12 Titanium
- TTAR6/9** Tiny TTA Rapid Cage 6/9 Titanium
- TTAR6/11** Tiny TTA Rapid Cage 6/11 Titanium
- TTAR6/13** Tiny TTA Rapid Cage 6/13 Titanium

TTA Rapid Star Drive 1.5mm Screw Titanium



Pilot drill - 1.1mm

- TTARI5STAR05** TTA Rapid Star Drive 1.5mm Screw Titanium 5mm
- TTARI5STAR06** TTA Rapid Star Drive 1.5mm Screw Titanium 6mm
- TTARI5STAR07** TTA Rapid Star Drive 1.5mm Screw Titanium 7mm
- TTARI5STAR08** TTA Rapid Star Drive 1.5mm Screw Titanium 8mm
- TTARI5STAR09** TTA Rapid Star Drive 1.5mm Screw Titanium 9mm
- TTARI5STAR10** TTA Rapid Star Drive 1.5mm Screw Titanium 10mm
- TTARI5STAR12** TTA Rapid Star Drive 1.5mm Screw Titanium 12mm
- TTARI5STAR14** TTA Rapid Star Drive 1.5mm Screw Titanium 14mm
- TTARI5STAR16** TTA Rapid Star Drive 1.5mm Screw Titanium 16mm
- TTARI5STAR18** TTA Rapid Star Drive 1.5mm Screw Titanium 18mm
- TTARI5STAR20** TTA Rapid Star Drive 1.5mm Screw Titanium 20mm

TTA Rapid Star Drive 2.0mm Screw Titanium



Pilot drill - 1.5mm

- TTAR20STAR05** TTA Rapid Star Drive 2.0mm Screw Titanium 5mm
- TTAR20STAR06** TTA Rapid Star Drive 2.0mm Screw Titanium 6mm
- TTAR20STAR07** TTA Rapid Star Drive 2.0mm Screw Titanium 7mm
- TTAR20STAR08** TTA Rapid Star Drive 2.0mm Screw Titanium 8mm
- TTAR20STAR09** TTA Rapid Star Drive 2.0mm Screw Titanium 9mm
- TTAR20STAR10** TTA Rapid Star Drive 2.0mm Screw Titanium 10mm
- TTAR20STAR12** TTA Rapid Star Drive 2.0mm Screw Titanium 12mm
- TTAR20STAR14** TTA Rapid Star Drive 2.0mm Screw Titanium 14mm
- TTAR20STAR16** TTA Rapid Star Drive 2.0mm Screw Titanium 16mm
- TTAR20STAR18** TTA Rapid Star Drive 2.0mm Screw Titanium 18mm
- TTAR20STAR20** TTA Rapid Star Drive 2.0mm Screw Titanium 20mm
- TTAR20STAR22** TTA Rapid Star Drive 2.0mm Screw Titanium 22mm
- TTAR20STAR24** TTA Rapid Star Drive 2.0mm Screw Titanium 24mm
- TTAR20STAR26** TTA Rapid Star Drive 2.0mm Screw Titanium 26mm

Screwdriver Shafts Star Drive



AO connection, self holding (no need for holding sleeve).

- TTARI28152015** Star-Drive T6 for 1.5mm Screws
- TTARI28152020** Star-Drive T8 for 2.0 & 2.4mm Screws

TTA Rapid L Shape Saw Guide For Tiny Cages



TTARI32404200 TTA Rapid L Shape Saw Guide For Tiny Cages 2 - 6mm

Twist Drills



- TTARI48008111** Twist Drill 1.1mm AO Shaft 60mm Long
- TTARI48008011** Twist Drill 1.1mm Round Shaft 45mm Long
- TTARI48008115** Twist Drill 1.5mm AO Shaft 85mm Long
- TTARI48008015** Twist Drill 1.5mm Round Shaft 70mm Long

Rapid Luxation Plating System

This technique is suitable for dogs which do not have a cruciate ligament rupture but suffer from a patella luxation.

Surgical protocol available on request.

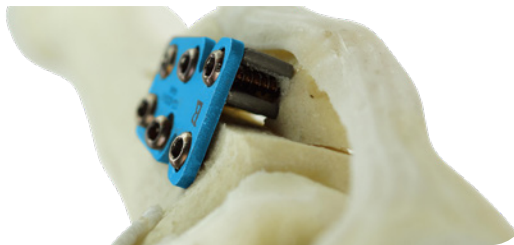

Rapid Luxation Set



Set supplied with hex head screws.

The Rapid Luxation Set contains:

- Sterilisation Tray with Lid x1
- Each 2.0mm Screw (6-20mm) (24 in total) x3
- Each 2.4mm Screw (6-40mm) (54 in total) x3
- Each Rapid Luxation Plate (3 pieces in total) x1
- Each Patellar Spacers (18 pieces in total) x1
- Large Sawguide with Pin & K-Wire x1
- Petite Sawguide with Pin & K-Wire x1
- Tibia Tappet - Petite x1
- Tibia Tappet - Standard x1
- Screwdriver Handle x1
- Screw Driver Shaft 2.4 + 2.0 with Holding Sleeve x1
- Plate Holding Forceps x1
- Depth Gauge x1
- Drill Guide x1
- Drills 1.5 & 1.8 x1

TTARI32800000 Rapid Luxation Set

Patellar Luxation Plate - Titanium



- 132-8200-01** Rapid Luxation Plate 6 Hole Titanium 1.5mm Thick for 2.4mm Screws
- 132-8200-02** Rapid Luxation Plate 4 Hole Titanium 1mm Thick for 2.4mm Screws
- 132-8200-03** Rapid Luxation Plate Petite 4 Hole Titanium 1mm Thick for 2mm Screws

TTA Rapid Tibial Tappet & Patellar Luxation Spacers

Patellar Luxation in combination with TTA Rapid

When a dog suffers from a cranial cruciate ligament rupture with a simultaneous patellar luxation, this can be addressed by using the Rita Leibinger Tibial Tappet and Patella Luxation Spacers during a modified TTA rapid procedure. Surgical protocol available on request.

TTA Rapid Patellar Luxation Spacers



Patella luxation spacers are made from titanium.

- TTARI32801002L** TTA Rapid Patellar Luxation Spacer 3 Holes 2mm Height Left
- TTARI32801002R** TTA Rapid Patellar Luxation Spacer 3 Holes 2mm Height Right
- TTARI32801004L** TTA Rapid Patellar Luxation Spacer 3 Holes 4mm Height Left
- TTARI32801004R** TTA Rapid Patellar Luxation Spacer 3 Holes 4mm Height Right
- TTARI32801006L** TTA Rapid Patellar Luxation Spacer 3 Holes 6mm Height Left
- TTARI32801006R** TTA Rapid Patellar Luxation Spacer 3 Holes 6mm Height Right



- TTARI32802002L** TTA Rapid Patellar Luxation Spacer 2 Holes 2mm Height Left
- TTARI32802002R** TTA Rapid Patellar Luxation Spacer 2 Holes 2mm Height Right
- TTARI32802003L** TTA Rapid Patellar Luxation Spacer 2 Holes 3mm Height Left
- TTARI32802003R** TTA Rapid Patellar Luxation Spacer 2 Holes 3mm Height Right
- TTARI32802004L** TTA Rapid Patellar Luxation Spacer 2 Holes 4mm Height Left
- TTARI32802004R** TTA Rapid Patellar Luxation Spacer 2 Holes 4mm Height Right



- TTARI32803001L** TTA Rapid Petite Tiny Pat Lux Spacer 2 Holes 1mm Height Left
- TTARI32803001R** TTA Rapid Petite Tiny Pat Lux Spacer 2 Holes 1mm Height Right
- TTARI32803002L** TTA Rapid Petite Tiny Pat Lux Spacer 2 Holes 2mm Height Left
- TTARI32803002R** TTA Rapid Petite Tiny Pat Lux Spacer 2 Holes 2mm Height Right
- TTARI32803003L** TTA Rapid Petite Tiny Pat Lux Spacer 2 Holes 3mm Height Left
- TTARI32803003R** TTA Rapid Petite Tiny Pat Lux Spacer 2 Holes 3mm Height Right
- TTARI32803004L** TTA Rapid Petite Tiny Pat Lux Spacer 2 Holes 4mm Height Left
- TTARI32803004R** TTA Rapid Petite Tiny Pat Lux Spacer 2 Holes 4mm Height Right

TTA Rapid Tibial Tappet



The uniquely-designed tibial tappet allows you to move the tibial tuberosity very accurately and test functionality of the new position during surgery, before fixating the screws. Once in the desired position you can fixate the patella spacers and screws.

- TTARI32407000** TTA Rapid Tibial Tappet Standard 2.4mm
- TTARI32407100** TTA Rapid Petite/Tiny Tibial Tappet 2.0mm

Triple Tibial Osteotomy (TTO) Instrumentation

To view our Surgery Guide on TTO, please scan the QR code below.

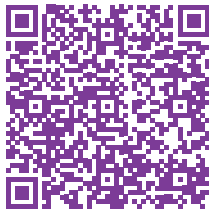

Dedicated instrumentation as designed by Warrick Bruce is required to make the procedure easier and to minimise errors.

Original TTO Instrumentation

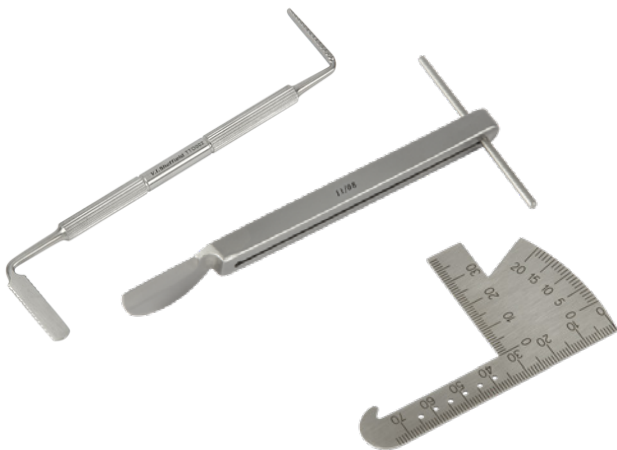

- TTO006** Basic Osteometer
- TTO004** Saw Cutting Guide (Standard 62mm)
- TTO002** Wedgie Segment Manipulator

Revised TTO Instrumentation

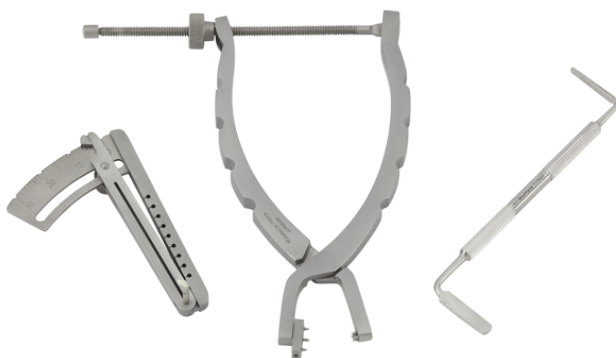

- TTO011** Combination Osteometer/Sawguide
- TTO014** TTO Clasper
- TTO002** Wedgie Segment Manipulator
- TTO009** Enhanced TTO Instrument Set (All of above)

TTO Plates

The Standard TTO Plate is a cloverleaf TPLO Plate. Being positioned over the caudal 2/3 of the tibia the plate selected is typically a little smaller than is the case with a wedge TPLO. Use the free plate overlay for the final selection. Thicker plates are harder to contour and a selection of pre-contoured plates are available.

- TPLO202026** 2.0mm DCP 26mm Overall Length
- TPLO202031** 2.0mm DCP 31mm Overall Length
- TPLO242434** 2.4mm DCP 34mm Overall Length
- TPLO242441** 2.4mm DCP 41mm Overall Length
- TPLO272739** 2.7mm DCP 39mm Overall Length
- TPLO272745** 2.7mm DCP 45mm Overall Length
- TPLO273539** 2.7/3.5 DCP 39mm Overall Length
Allows Use Of 3.5mm Cancellous Screw In Head
- TPLO273545** 2.7/3.5 DCP 45mm Overall Length 2.5mm Thick
- TPLO353555** 3.5mm DCP 55mm Overall Length
- TPLO353557** 3.5mm DCP 57mm Overall Length Heavy Duty
- TPLO353559** 3.5mm DCP 59mm Overall Length
- TPLO353562** 3.5mm DCP 62mm Overall Length
- TPLO353565** 3.5mm DCP 65mm Overall Length
- TPLO353577** 3.5mm DCP 77mm Overall Length
- TPLO353577X** 3.5mm DCP 77mm Overall Length Extra Shaft Hole
- TPLO353579** 3.5mm DCP 79mm Overall Length Heavy Duty
- TPLO354579** 3.5/4.5 DCP 79mm Overall Length Heavy Duty
Allows 4.5mm Screws In Head
- TPLO35456579** 79mm Overall Length Heavy Duty
Allows 4.5/6.5mm Screws In Head
- TPLO45659030** 4.5mm DCP 90mm Overall Length
Will Accept 6.5mm Cancellous Screws In Head 3.0mm Thick
- TPLO45659035** 4.5mm DCP 90mm Overall Length
Will Accept 6.5mm Cancellous Screws In Head 3.5mm Thick
- TPLO45659045** 4.5mm DCP 90mm Overall Length
Will Accept 6.5mm Cancellous Screws In Head 4.5mm Thick
- TPLOO** Angle Finder & Plate Overlay

Pre-Contoured TTO Plates

- TPLO353555PCR** 3.5mm Plate 55mm Overall Length Right
- TPLO353555PCL** 3.5mm Plate 55mm Overall Length Left
- TPLO353557PCR** 3.5mm Plate 57mm Overall Length Right
- TPLO353557PCL** 3.5mm Plate 57mm Overall Length Left
- TPLO353579PCR** 3.5mm Plate 79mm Overall Length Right
- TPLO353579PCL** 3.5mm Plate 79mm Overall Length Left

Lateral Suture Starter Kits

To view our Surgery Guide on Lateral Sutures, please scan the QR code below.



LigaFiba® Lateral Suture With Crimp Starter Kit



The LigaFiba® Lateral Suture With Crimp Starter Kit contains:

091135M	Compound Action Crimping Forceps for LigaFiba/12-14mm Crimps	x1
091153	Heavy Duty Needle Driver With Tungsten Jaws	x1
LFSI40TC	LigaFiba Scissor 140mm 5.5" Curved Tungsten Carbide	x1
LFLSCR150	LigaFiba Lateral Suture Plus Crimp Tube (150 x 500mm)	x2
LFLSCR250	LigaFiba Lateral Suture Plus Crimp Tube (250 x 500mm)	x2
LFLSCR500	LigaFiba Lateral Suture Plus Crimp Tube (500 x 600mm)	x2

The LigaFiba® Lateral Suture With Crimp Starter Kit For Smaller Breeds contains:

091135M	Compound Action Crimping Forceps for LigaFiba/12-14mm Crimps	x1
091153	Heavy Duty Needle Driver With Tungsten Jaws	x1
LFSI40TC	LigaFiba Scissor 140mm 5.5" Curved Tungsten Carbide	x1
LFLSCR75	75 LigaFiba Lateral Suture Plus Crimp Tube	x2
LFLSCR150	150 LigaFiba Lateral Suture Plus Crimp Tube	x2
LFLSCR250	250 LigaFiba Lateral Suture Plus Crimp Tube	x2

LFLSCRSTARTER
LFLSCRSTARTER/S

LigaFiba® Lateral Suture with Crimp Starter Kit
LigaFiba® Lateral Suture with Crimp Starter Kit For Smaller Breeds

Nylon Lateral Suture Starter Kits



This Vi Starter Kit contains:

091135	Crimping Forceps	x1
091155	50lb Nylon Line with Swaged on Needle & Crimp	x2
091156	80lb Nylon Line with Swaged on Needle & Crimp	x2
091157	100lb Nylon Line with Swaged on Needle & Crimp	x2
091154	CCL Suture System (Swaged on) Basic Kit Crimping Forceps	
	2x Each Size Nylon/Needle/Crimp Sterile Packs	



This Vi Starter Kit contains:

091135C	Compound Action Crimping Forceps	x1
091155	50lb Nylon Line with Swaged on Needle & Crimp	x2
091156	80lb Nylon Line with Swaged on Needle & Crimp	x2
091157	100lb Nylon Line with Swaged on Needle & Crimp	x2
091150	CCL Suture System (Swaged On) Compound Action Kit	
	2x Each Size Nylon/Needle/Crimp Sterile Packs	



This Vi Starter Kit contains:

091135	Crimping Forceps	x1
091153	Heavy Duty Needle Driver	x1
091155	50lb Nylon Line with Swaged on Needle & Crimp	x2
091156	80lb Nylon Line with Swaged on Needle & Crimp	x2
091157	100lb Nylon Line with Swaged on Needle & Crimp	x2
091151	CCL Suture System (Swaged On) Basic Kit Plus	
	Forceps 2x Each Size Nylon/Needle/Crimp Sterile Packs	
	Plus Heavy Duty Needleholders	

Lateral Suture Using LigaFiba®

LigaFiba® Lateral Sutures

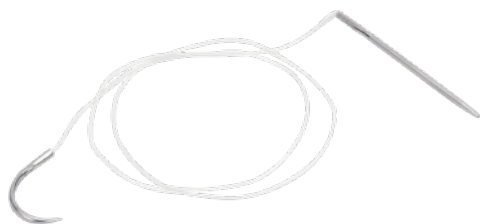

Extreme strength, minimal stretch and good abrasion-resistance characteristics make LigaFiba® an ideal material for lateral sutures. The loop may be either tied or crimped at the end of the procedure. LigaFiba® for any given diameter is more than twice as strong as monofilament nylon. Lateral sutures are supplied with size-appropriate cruciate needle on one end and a straight round bodied needle at the other. Supplied sterile.

- LFLS75** 75 LigaFiba® Lateral Suture (300mm)
- LFLS150** 150 LigaFiba® Lateral Suture (500mm)
- LFLS250** 250 LigaFiba® Lateral Suture (500mm)
- LFLS500** 500 LigaFiba® Lateral Suture (600mm)

Double LigaFiba® Lateral Suture



Double strand presentation with no crimps. Supplied sterile.

- LFLS250D** Double 250 LigaFiba® Lateral Suture (500mm)

LigaFiba® Lateral Sutures With Crimp



LigaFiba® does knot securely but for maximum security requires 6 throws which creates a rather bulky knot. Crimping creates a secure, low profile, radio-dense join between the free ends of LigaFiba®. To make passing the LigaFiba® through the crimp a simple process the 25mm of LigaFiba® nearest the needle has been processed to minimise fraying. Always cut the lateral suture near the needle. Supplied sterile.

- LFLSCR75** 75 LigaFiba® Lateral Suture (300mm) + Crimp
- LFLSCR150** 150 LigaFiba® Lateral Suture (500mm) + Crimp
- LFLSCR250** 250 LigaFiba® Lateral Suture (500mm) + Crimp
- LFLSCR250D** Double 250 LigaFiba® Lateral Suture (500mm) with 2 Crimps
- LFLSCR500** 500 LigaFiba® Lateral Suture (600mm) + Crimp

LigaFiba® Scissors



LigaFiba® is so tough it is difficult to cut and will damage standard scissors. Use our special T.C. Scissors with a custom cutting edge.

- LFS140TC** LigaFiba® Scissors T.C. 145mm

Compound Action Crimpers For LigaFiba®



The compound action crimper delivers a pre-measured crimp with minimal effort. The jaw cut-outs prevent over crimping. These crimpers require the least effort of any Vi crimper available. The compound action crimper is suitable for all crimps apart from the thin-walled 10mm crimp for 50lb nylon which suits the standard simple action crimper.

- 091135M** LigaFiba® Compound Action Crimpers 245mm

LigaFiba® Crimps

Spare crimps for LigaFiba®. Please note that only the LigaFiba® Crimper is powerful enough for LigaFiba® Crimps.

- LFCRIMP75** Crimp for 75 LigaFiba®
- LFCRIMP150** Crimp for 150 LigaFiba®
- LFCRIMP250** Crimp for 250 LigaFiba®
- LFCRIMP500** Crimp for 500 LigaFiba®

Lateral Suture Using Nylon

Sterile CCL Packs

Monofilament line used as a lateral suture (De Angelis style) is an accepted CCL treatment method. Crimping is strongly recommended as the knots formed tend to be large, often causing seroma reactions and pain due to soft tissue irritation.

Packs are supplied sterile. Re-autoclaving is not recommended as this reduces the strength and increases the elasticity of the material.

Double sutures are supplied swaged on as a loop for use of the self-locking McKee/Miller knot (VCOT 1999;12:78-80) or with 2 crimps. One needle passes around the fabella allows two lines to be placed with less peri-fabellar damage.

Sterile Leader Line + Crimp + Needle

Procedure packs containing suture, swaged on needle and crimp.



- 091155 50lb Nylon Line x 500mm On Swaged-On V. Small Fabella Needle + 10mm Crimp (Sterile)
- 091156 80lb Nylon Line x 800mm On Swaged-On Small Fabella Needle + 12mm Crimp (Sterile)
- 091157 100lb Nylon Line x 800mm On Swaged-On Medium Fabella Needle + 12mm Crimp (Sterile)

Double Leader Line + Needle + Crimps

For the application of double lines with the single pass of a needle.

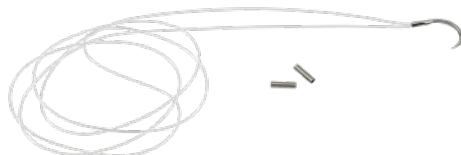

- 091165 50lb Double Line (500mm x 2 As Loop) On V Small Fabella Needle Plus 2 x 10mm Crimps (Sterile)
- 091166 80lb Double Line (800mm x 2 As Loop) On Small Fabella Needle Plus 2 x 12mm Crimps (Sterile)
- 091167 100lb Double Line (800mm x 2 As Loop) On Medium Fabella Needle Plus 2 x 12mm Crimps (Sterile)



Double Leader Line Loop on Needle

For use with McKee/Miller knot.

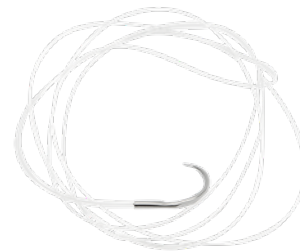

- 091160 50lb Double Line (500mm x 2 As Loop) On V Small Fabella Needle
- 091161 80lb Double Line (800mm x 2 As Loop) On Small Fabella Needle
- 091162 100lb Double Line (800mm x 2 As Loop) On Medium Fabella Needle

Sterile Leader Line + Crimp

For use with separate Fabella (Cruciate) Needles.

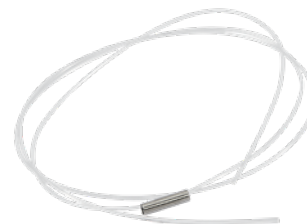

- 091142 10mm Tube Crimp + 500mm x 50lb Nylon (Sterile Pack)
- 091137 12mm Tube Crimp + 800mm x 80lb Nylon (Sterile Pack)
- 091147 12mm Tube Crimp + 800mm x 100lb Nylon (Sterile Pack)



ViPP

Through a true partnership approach, you can deliver quantifiable rewards for you and your Practice by joining our **Veterinary Instrumentation Partnership Programme**.

To find out more, scan the QR code below.

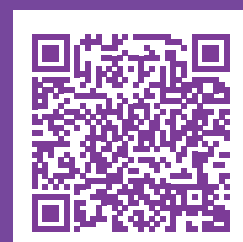

Sterile Nylon Leader Line

Also useful for other ligament replacement procedures, e.g. hip toggle, collateral ligament repair.



- 091141 500mm x 50lb Nylon (Sterile Pack)
- 091139 800mm x 80lb Nylon (Sterile Pack)
- 091148 800mm x 100lb Nylon (Sterile Pack)

Crimps



Crimps supplied non-sterile.

- 091140 10mm Tube Crimp for 50lb Line
- 091136 12mm Tube Crimp for 80lb + 100lb Line
- 091133 14mm Tube Crimp Suitable For Nylon Over 100lb
- 091140/10 10mm Tube Crimp For 50lb Line Pack of 10
- 091136/10 12mm Tube Crimp For 80lb+100lb Line Pack of 10
- 091133/10 14mm Tube Crimp Suitable For Nylon Over 100lb Pack of 10

Fabella (Cruciate) Needles

Most surgeons use our sterile procedure packs which include swaged on needle and appropriate crimps. Some surgeons prefer to use non swaged on needles although do bear in mind that leader line passed through a regular needle creates more damage as it passes through the femoro-fabella ligament. It is this ligament which is relied on for the holding power of the suture. Cruciate needles will pass through a hole created with a 2.7mm bone tunnel borer into the tibial crest.



- 091144VS Fabella Needle Very Small - Pack of 6 Has Regular Eye 16mm x 1.57mm
- 091144 Fabella Needle Small - Pack of 6 Has Regular Eye 21mm x 1.58mm
- 091145 Fabella Needle Medium - Pack of 6 Has Regular Eye 27mm x 1.58mm
- 091146 Fabella Needle Large - Pack of 6 Has Regular Eye 37mm x 1.57mm

Which line should I choose?

If a patient is above their ideal bodyweight, is particularly boisterous, or if there are concerns about post-operative compliance, a surgeon may chose to go up a size at their own discretion.

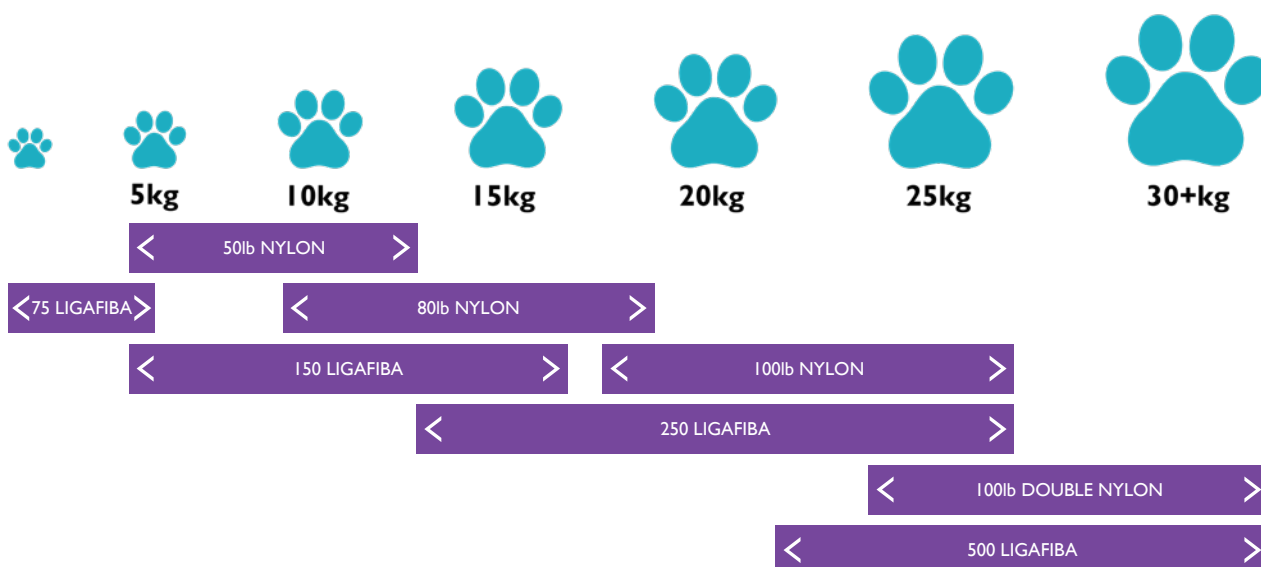

Instrumentation For Lateral Suture Crimping Forceps



Basic simple action crimper for monofilament line only.

091135 Crimping Forceps 195mm Long

Compound Action Crimper



Compound action crimper for monofilament line only, for both 10 and 12mm crimps. Delivers a more powerful crimp than the standard crimper.

091135C Compound Action Crimper 230mm Long

Compound Action Crimpers For LigaFiba®



The compound action crimper delivers a pre-measured crimp with minimal effort. The jaw cut-outs prevent over crimping. These crimpers require the least effort of any Vi crimper available. The compound action crimper is suitable for all crimps apart from the thin walled 10mm crimp for 50lb Nylon which suits the standard simple action crimper.

091135M LigaFiba® Compound Action Crimpers 245mm

Correct Crimping

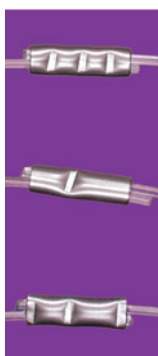

✓ **Correct.**
Three evenly spaced crimps

✗ **Incorrect.**
Not enough crimps

✗ **Incorrect.**
Crimps too close to end of tube

Loop Tension Devices

Prior to crimping it is suggested that the loop be tensioned sufficiently to eliminate the anterior draw, but not enough to create an outward rotation. Many surgeons achieve this by hand but others may choose to use a tensioning device.

CCL Tensioning Device



Simple tension device requiring a pair of standard Gelpis.

091132P CCL Tensioning Device (Pair)

CCL Loop Tensioning



Leader line gripped by thumbscrew.

Does not require use of extra crimps - less wasteful.

Speed lock type action gives more 'feel' than ratchet type.

Jaws designed specifically for crimping system.

091132A CCL Loop Tensioner 175mm

Lateral Suture Tension Device



Ratchet based, it relies on the jaws pulling against crimps attached to the free ends of the loop. It is simple and effective but does require two extra crimps which are ultimately discarded.

091158 Lateral Suture Tensioner 170mm

Fixed Handle Bone Tunnel Borer



- 001070X Fixed Handle Bone Tunnel Borer 2mm
- 001073X Fixed Handle Bone Tunnel Borer 2.5mm
- 001071X Fixed Handle Bone Tunnel Borer 2.7mm
- 001072X Fixed Handle Bone Tunnel Borer 3.5mm

LigaFiba® Scissors



LigaFiba® is so tough it is difficult to cut and will damage standard scissors. Use our special T.C. Scissors with a custom cutting edge.

LFS140TC LigaFiba® Scissors T.C. 145mm

Heavy Duty Needle Driver



The large needles used for cruciate lateral suture placement, along with the force needed to pass them, will damage standard needleholders. A dedicated heavy duty TC needle driver kept with the cruciate kit will prove more cost effective, and improve grip on the needle.

091153 Heavy Duty Needle Driver With Tungsten Jaws 195mm Long



Training & Education

Our **e-learning platform** delivers a variety of technical and clinical educational material, in an engaging and interactive format.

With a CPD certificate awarded upon successful completion of each module, the e-learning platform from Vi will help you to fulfil your annual CPD requirements.

Sign up today by scanning the QR code below.



Lateral Button Suture

To view our Surgery Guide on Lateral Button Sutures, please scan the QR code below.

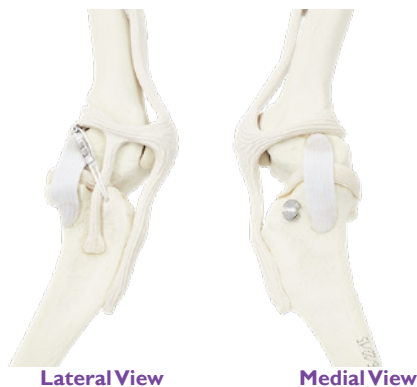

LigaFiba® Lateral Button Suture With Crimp Starter Kit



The LigaFiba® Lateral Titanium Button Suture With Crimp Starter Kit - Standard contains:

- 091135M Compound Action Crimping Forceps for LigaFiba/12-14mm Crimps x1
- 091153 Heavy Duty Needle Driver With Tungsten Jaws x1
- LFS140TC LigaFiba Scissor 140mm 5.5" Curved Tungsten Carbide x1
- LFLBS150TI 150 LigaFiba Lateral Button Suture TI Button x2
- LFLBS250TI 250 LigaFiba Lateral Button Suture TI Button x2
- LFLBS500TI 500 LigaFiba Lateral Button Suture TI Button x2

The LigaFiba® Lateral Titanium Button Suture With Crimp Starter Kit - Small contains:

- 091135M Compound Action Crimping Forceps for LigaFiba/12-14mm Crimps x1
- 091153 Heavy Duty Needle Driver With Tungsten Jaws x1
- LFS140TC LigaFiba Scissor 140mm 5.5" Curved Tungsten Carbide x1
- LFLBS75TI 75 LigaFiba Lateral Button Suture TI Button x2
- LFLBS150TI 150 LigaFiba Lateral Button Suture TI Button x2
- LFLBS250TI 250 LigaFiba Lateral Button Suture TI Button x2

LFLBSSTARTERTI LigaFiba® Lateral Titanium Button Suture With Crimp Starter Kit - Standard

LFLBSSTARTERTI/S LigaFiba® Lateral Titanium Button Suture With Crimp Starter Kit - Small

LigaFiba® Lateral Titanium Button Suture



- LFLBS75TI** 75 LigaFiba® Lateral Button Suture Ti Button
- LFLBS150TI.** 150 LigaFiba® Lateral Button Suture Ti Button
- LFLBS250TI.** 250 LigaFiba® Lateral Button Suture Ti Button
- LFLBS500TI.** 500 LigaFiba® Lateral Button Suture Ti Button

Which line should I choose?

If a patient is above their ideal bodyweight, is particularly boisterous, or if there are concerns about post-operative compliance, a surgeon may choose to go up a size at their own discretion.

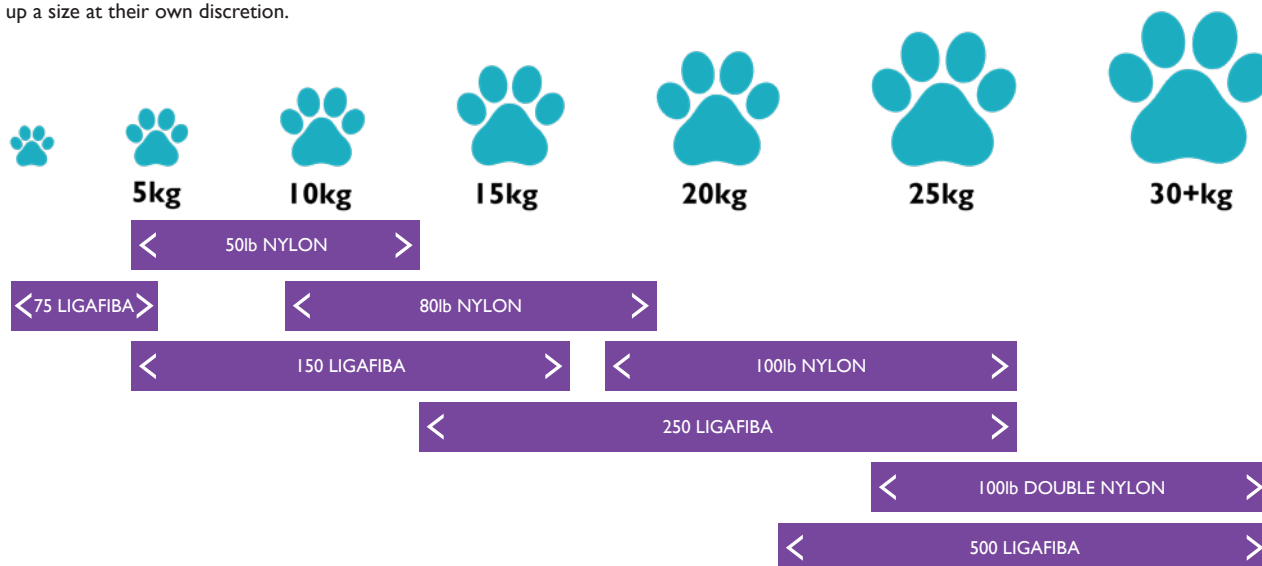

Nylon Lateral Button Suture



- NLBS50TI** 50lb Nylon Lateral Button Suture With Titanium Button
- NLBS80TI** 80lb Nylon Lateral Button Suture With Titanium Button
- NLBS100TI** 100lb Nylon Lateral Button Suture With Titanium Button

LigaFiba® Isotoggle

To view our Surgery Guide on LigaFiba® Isotoggle, please scan the QR code below.



Lateral view Cranial view Medial view

The Isotoggle suture is placed via bone tunnels across the stifle at isometric points. The use of isometric points maximises the range of movement of the stifle and protects the suture from repeated stretching and abrasion. The suture is anchored over buttons on the medial side.

- LFITS150TI** 150 Isotoggle Suture Set
- LFITS250TI** 250 Isotoggle Suture Set
- LFITS500TI** 500 Isotoggle Suture Set

Isotoggle Aiming Device - Adjustable Drill Guide

Useful for the placement of the femoral bone tunnel which can be more challenging than the tibial tunnel. Adjustable Drill Guide with an appropriately sized drill slider may be used to pre-determine the line of the tunnel and offer protection of the soft tissues. The arms of the guide have sufficient 'spring' in them so if pre-stressed the guide is self-retaining.



- ADJDG2035** Adjustable Drill Guide 175mm
- KWG10** K-Wire Guide For ADJDG2035

Isotoggle Consumables

Drill Bits

- H090102AS** 2.0mm Antiskid Drill (150) 100mm
- H090112AS** 2.5mm Antiskid Drill (250) 115mm
- H090106L** 3.5mm Round Shank Drill 180mm

Titanium Buttons



- TIBUT6H** Titanium Button 6mm 2 Holes
- TIBUT6S** Titanium Button 6mm 2 Slots
- TIBUT9H** Titanium Button 9mm 2 Holes
- TIBUT9S** Titanium Button 9mm 2 Slots
- TIBUT11H** Titanium Button 11mm 2 Holes
- TIBUT11S** Titanium Button 11mm 2 Slots

LigaFiba® Isotoggle Interference Screw



The LigaFiba® interference screw offers an alternative to tying over a button. The screw has a tapered, soft profile thread which jams the LigaFiba® into the bone tunnel.

- LFIS253518SS** Interference Screw 3.5mm Stainless 18mm
- LFIS354523SS** Interference Screw 4.5mm Stainless 23mm

Suture Screws

Suture screws are a self-tapping screw with an eyed head, designed to be used as a versatile, economic suture anchor. The thread pattern is the same as the equivalent type of cortical or cancellous screw.

Pre drill with the standard pilot for the screw size selected, screw in with the dedicated insertion tool.



The Suture Screw Set contains:

	Box and Insert for Suture Anchor Set (Not sold separately)	x1
SSITUN	Universal Insertion Tool for all Suture Screws	x1
SS2006	Suture Screw Cortical 2.0mm x 6mm	x2
SS2010	Suture Screw Cortical 2.0mm x 10mm	x2
SS2708	Suture Screw Cortical 2.7mm x 8mm	x2
SS2714	Suture Screw Cortical 2.7mm x 14mm	x2
SS3512	Suture Screw Cortical 3.5mm x 12mm	x2
SS3520	Suture Screw Cortical 3.5mm x 20mm	x2
SS4016	Suture Screw Cancellous 4.0mm x 16mm	x2
SS4024	Suture Screw Cortical 4.0mm x 24mm	x2
LF150500	LigaFiba 150 x 500mm (Sterile)	x1
LF250600	LigaFiba 250 x 600mm (Sterile)	x1
LF500600	LigaFiba 500 x 600mm (Sterile)	x1

SSITKIT	Suture Screw Set
SS2006	2.0mm Diameter 6mm Long 1.0mm Hole Cortical
SS2010	2.0mm Diameter 10mm Long 1.0mm Hole Cortical
SS2708	2.7mm Diameter 8mm Long 1.5mm Hole Cortical
SS2714	2.7mm Diameter 14mm Long 1.5mm Hole Cortical
SS3512	3.5mm Diameter 12mm Long 2.0mm Hole Cortical
SS3520	3.5mm Diameter 20mm Long 2.0mm Hole Cortical
SS4016	4.0mm Diameter 16mm Long 2.0mm Hole Cancellous
SS4024	4.0mm Diameter 24mm Long 2.0mm Hole Cancellous
SSITUN	Universal Insertion Tool For All Suture Screws

Suture Anchor Pin

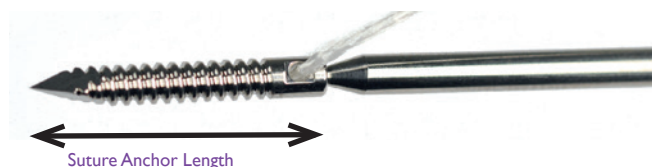

A threaded suture anchor is machined into the tip of a trochar pin. Immediately proximal to the suture anchor is a narrow break-off point. The construct is stable during axial drilling of the pin into bone. Once in position with the hole of the anchor just above the surface of the bone the shaft of the pin is rocked to and fro. The stainless steel undergoes work hardening and becomes very brittle, ultimately breaking off leaving the anchor in position ready for placement of sutures. The suture anchor pin is extremely easy to position and place without pre-drilling. Length of pin into the bone is (approx) 2.5mm - 12mm, 3.0mm - 14mm and 4.0mm - 20mm.

SAP2.5	Suture Anchor Pin 2.5mm Diameter 1.0mm Hole 17mm Suture Anchor Length 125mm Overall Length
SAP3	Suture Anchor Pin 3mm Diameter 1.0mm Hole 21mm Suture Anchor Length 127mm Overall Length
SAP4	Suture Anchor Pin 4mm Diameter 2.0mm Hole 26mm Suture Anchor Length 136mm Overall Length

LigaFiba® Tendon & Ligament Sutures

LigaFiba® is available in sterile single lengths for use in conjunction with any suitable suture anchor system.

LF150500	150 LigaFiba® x 500mm <15kg
LF250600	250 LigaFiba® x 600mm 15 - 30kg
LF500600	500 LigaFiba® x 600mm >30kg

Meniscus Surgery

Meniscus Surgery Set



Management of meniscal injuries has three phases, all of which will require special instrumentation.

- Exposure of the meniscus, particularly the caudal horn of the medial meniscus. This will require that the tibia is advanced and distracted relative to the femur.
- Examination of the meniscus for lesions. A visual examination is not enough. The surface of the meniscus should be probed for defects and tears. The circumferential attachments should be checked for integrity.
- Any lesions discovered must be treated/managed as appropriate.

The Enhanced Meniscus Surgery Set contains:

001112	Stifle Distractor (Spread: Min. 8mm, Max 30mm)	x1
001113	Small Joint Distractor 140mm Long 6mm Wide Tips	x1
06054	Vi Fine Stainless Steel Beaver Type Scalpel Handle 130mm	x1
05905	Fine Stainless Steel Blades Sm65 (Box of 25)	x1
103180	Halstead Mosquito Forceps Straight 5" 125mm - 1/2 Teeth	x1
001048	Mini Hohman Retractor 8mm Short Tip	x1
AR-17-11X	Meniscus Push Knife Knurled Stainless Handle	x1
AR-17-19X	Meniscus Hook Knife Knurled Stainless Handle	x1
001409	2mm Meniscus Probe Nerve Hook 2mm	x1
BX221250	Stainless Steel Box 220mm x 120mm x 50mm	x1
BXSIL2212	Silicone Insert for Box 220mm x 120mm	x1

001117 Enhanced Meniscus Surgery Set



The Meniscus Surgery Set contains:

001112	Stifle Distractor (Spread: Min. 8mm, Max 30mm)	x1
001408	Meniscus Probe 1mm / Nerve Hook 1mm	x1
06054	Vi Fine Stainless Steel Beaver Type Scalpel Handle 130mm	x1
05905	Fine Stainless Steel Blades Sm65 (Box of 25)	x1
103180	Halstead Mosquito Forceps Straight 5" 125mm - 1/2 Teeth	x1
001048	Mini Hohman Retractor 8mm Short Tip	x1
BX221250	Stainless Steel Box 220mm x 120mm x 50mm	x1
BXSIL2212	Silicone Insert for Box 220mm x 120mm	x1

001116 Meniscus Surgery Set

Meniscus Instrumentation

Hook Knife & Push Knife



These three hand-held knives can deal with most meniscal tears. Their low profile makes them suitable for both open and arthroscopic surgeries.

- AR-17-19XS** Hook Knife 150mm
- AR-17-19X** Hook Knife 225mm
- AR-17-11X** Push Knife 225mm

Stifle Lever



Exposure of the medial meniscus is never easy. Access is limited. The stifle levers are designed to fit the trochlea, while the atraumatic tip hooks behind the caudal tip of the tibial plateau. The levering action spreads the load over the surface of the trochlea, more effectively than a Hohman. Two sizes to cover most cases.

- 001115** Stifle Lever >20kg 225mm
- 001115S** Stifle Lever Small <20kg 165mm

Arthroscopic Stifle Lever VSTL



The arthroscopic stifle lever is finer and longer than the standard version, making it more suitable for arthroscopic surgery.

The good-sized white PTFE handle has a useful notch which aligns with the tip orientation of the lever. Not just for arthroscopy – useful in open arthrotomies as well.

Developed for stifle surgery by Ian Holsworth.

- AR-17-02** Arthroscopic Stifle Lever VSTL 280mm

Meniscus Probes

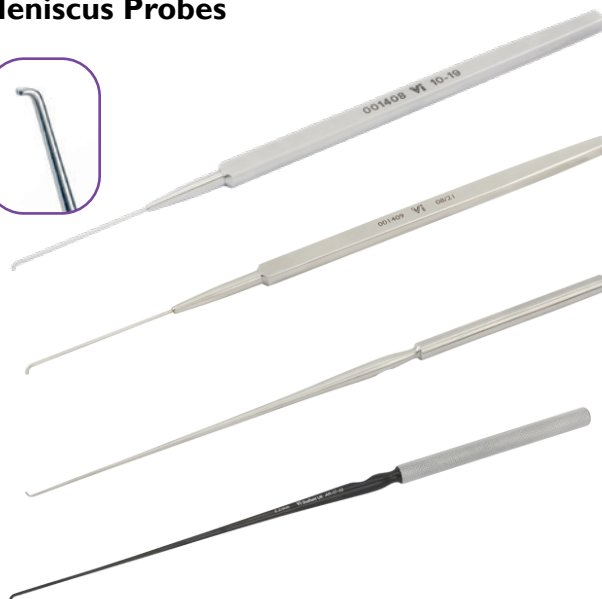

Used to probe the meniscus to check for tears, which may not be seen easily.

1mm – dogs up to 30kgs 2mm – dogs over 30kgs

- 001408** Meniscus Probe 1mm Tip 190mm
- 001409** Meniscus Probe 2mm Tip 220mm
- 001409A** Meniscus Probe 2mm Tip Heavy Pattern
- AR-17-10** Meniscus Probe 2.2mm Black Shaft For Arthroscopy 220mm



Toothed Halsteads



Very useful for grasping the meniscus.

- 103185 Halstead Mosquito Forceps 1/2 Teeth Cof 125mm
- 103180 Halstead Mosquito Forceps 1/2 Teeth Str 125mm

Senn (Cats Paw) Retractor



- 833305 Senn Retractor Sharp (Cats Paw) 160mm
- 833310 Senn Retractor Blunt (Cats Paw) 160mm

Fat Pad Retractor



Visualisation of the medial meniscus is maximised by retraction of the fat pad. Previously this has been achieved by use of a Senn (Cats Paw) retractor. The fat pad retractor has the same clawed foot but has a much more practical means of holding the instrument.

- 001114 Fat Pad Retractor 180mm
- 001145 Fat Pad Retractor Small 180mm



Meniscectomy Instruments



Purpose designed, the jaws of the Ligament Clamp have multiple small gripping teeth to combat synovial fluid slip. The T handle push knife is only sharp on the inner curve, not at the tips. Suitable for larger patients.

- 001107 Meniscectomy Knife 165mm
- 001110 Ligament/Cartilage Clamp 140mm
- 001100 Meniscectomy Instrument Set (As above)



Loan Kits

For a nominal fee, we have a range of **specialist loan kits** available to complement your own fleet. With next working day availability, the service offers flexibility as procedures are booked with your clients.

To find out more, scan the QR code below.



Stifle Distractors



When closed, the tips of the Stifle Distractor overlap. This reduces the profile of the tips and minimises the chance of iatrogenic damage when inserting the device into the joint space.



Designed to separate the femoral component of the stifle from the tibia. For the best exposure, joint surfaces should move away from each other in a parallel fashion, exposing the meniscus in its natural state and minimally distorted by the examination.

Positioning:

- One tip is placed in the intercondylar notch.
- The other on the cranial intercondylar area.
- Neither tip should involve articular cartilage.
- Test distraction (by squeezing the handles) to find the exact point at which a full distraction will expose the meniscus.
- Engage the spinlock to open the joint.

00112/L Stifle Distractor Large Min Spread 10mm
Max Spread 40mm 210mm Long

00112 Stifle Distractor Min Spread 8mm Max Spread 30mm 190mm Long

00112S Stifle Distractor Small Min Spread 6mm Max Spread 20mm

00112XS Stifle Distractor Extra Small

Small Stifle Distractor



The small distractor is also useful as small local muscle and tissue retractors in and around canine joints e.g. elbow exploration. Total length 130mm.

00113 Small Joint Distractor/Retractor 6mm Wide Tips

Very Small Stifle Distractor



The very small distractor is extremely useful as a small joint retractor during the meniscal release procedure. It is used to open a small window, caudal to the medial collateral. Total length 140mm.

00113VS V Small Joint Distractor/Retractor 3mm Wide Tips

Miniature Stifle Distractor



Scaled-down version of the very small stifle distractor for use in small and miniature breeds. Same overlapping tip pattern shown in all Vi stifle distractors.

00113VSX Miniature Stifle Distractor 100mm

Spinlock Stifle Distractor



Alternative spinlock version of the ratcheted stifle distractors. Spinlocks avoid the slippage which can occur with ratchets, and allow incremental opening of the joint which is not dependant on the tooth pitch of a ratchet.

00113SL Spinlock Small Stifle Distractor 140mm 6mm Tips

00113VSSL Spinlock Very Small Stifle Distractor 140mm 3mm Tips

Gelpi Self Retaining Retractor



Measurement 'a' gives the depth of the tips.

Available as singles or sets of two.

- 001330** Gelpi Retractor 120mm Spread (a=20mm) 180mm Long
- 001330SL** Gelpi Retractor With Spinlock (a=20mm) 180mm Long
- 001330S** Gelpi Retractor Sharp Tips (a=20mm) 180mm Long
- 001331** Gelpi Long Reach (a=40mm) 200mm Long
- 001331L** Gelpi Very Long Reach (a=60mm) 200mm Long
- 001332** Gelpi Small 60mm Spread (a=15mm) 135mm Long
- 0013301** Gelpi Mini Flat 45mm Spread (a=15mm) 90mm Long
- 0013302** Gelpi Mini Curved 45mm Spread (a=15mm) 90mm Long
- 0013303** Gelpi Mini Curved 45mm Spread Blunt Tips 90mm Long



- 001330/2** Gelpi Retractors 120mm Spread (a=20mm) 180m Long Set of 2
- 001330SL/2** Gelpi Retractors With Spinlock(a=20mm) 180mm Long Set of 2
- 001330S/2** Gelpi Retractors Sharp Tips (a=20mm) 180mm Long Set of 2
- 001331/2** Gelpi Long Reach (a=40mm) 200mm Long - Set of 2
- 001331L/2** Gelpi Very Long Reach (a=60mm) 200mm Long - Set of 2
- 001332/2** Gelpi Small 60mm Spread (a=15mm) 135mm Long - Set of 2
- 0013301/2** Gelpi Mini Flat 45mm Spread (a=15mm) 90mm Long - Set of 2
- 0013302/2** Gelpi Mini Curved 45mm Spread (a=15mm) 90mm Long - Set of 2
- 0013303/2** Gelpi Mini Curved 45mm Spread 90mm Long Blunt Tips - Set of 2



Small Stifle Ronguers



Small ronguers with angled slim jaws, useful for work within the stifle to remove CrCL remnants or to apply tension to meniscal tissue prior to sharp resection.

001301 Small Stifle Ronguer 1.75mm Bite 140mm Long



Email Marketing Service

Our marketing emails are designed to **educate**, to keep you up to date with what's new at Vi and share **exclusive offers and discounts**.

Sign up today by scanning the QR code below.



Patellar Luxation

To view our Surgery Guide on Patellar Luxation please scan the QR code below.



Modular Osteotome With Ultra-Thin Interchangeable Blades & Diamond Rasp



PTFE osteotome handle which accepts a good range of blades plus a diamond rasp (not included in set). Blades are very thin (1.1mm) allowing fine cuts and reducing the incidence of breaking the block during block sulcoplasty procedures. Replacement T wrench and retaining screw are also available.

- 001380 Modular Osteotome With 7 Blades
- 001382 Modular Osteotome Replacement Blade 4mm
- 001390 Modular Osteotome Replacement Blade 5mm
- 001383 Modular Osteotome Replacement Blade 6mm
- 001384 Modular Osteotome Replacement Blade 8mm
- 001385 Modular Osteotome Replacement Blade 10mm
- 001386 Modular Osteotome Replacement Blade 12mm
- 001387 Modular Osteotome Replacement Blade 15mm
- 001388 Modular Osteotome Replacement Blade 20mm
- 001389 Modular Diamond Rasp 6mm
- 001380SCREW Spare Screw For Modular Osteotome
- TBHEX40 4.0mm T Bar Hex Driver

Gordon Coronoid Osteotome



Originally developed for surgery on the medial coronoid, its thin, sharp blade and narrow widths are making this tool increasingly popular amongst surgeons for block sulcoplasty.

- AR-17-30 Gordon Coronoid Osteotome 4mm
- AR-17-29 Gordon Coronoid Osteotome 2mm

Orthopaedic Hard Back Saw



Made from stainless steel. The stiff back helps to guide the saw.

- 001004 Orthopaedic Hard Back Saw

Adjustable Bone Saw



Useful for completing/squaring off the osteotomy, this saw comes complete with five, fine chrome plated blades. Blade length is adjustable from 40mm to 100mm. Handle length 130mm. Blade length 155mm.

- 001000 Adjustable Bone Saw With 5 Fine Blades
- 001001-A Spare Fine Blades Pack of 5 Chrome Plated
- 001000SS-A Adjustable Saw Blade Single Sterile
- 001002 Coarse Stainless Blade

Patella Saw



With standard sawblade including Allen Wrench 1.5mm.

- LEI23100590 Patella Saw
- LEI23100520 Patella Saw Replacement Blade
- LEI23100521 Patella Saw Allen Wrench

Universal Sulcoplasty Rasp



Double ended rasp, 210mm long. Rectangular end for adjusting block sulcoplasties, triangular end for adjusting wedge sulcoplasties.

Improved tooth geometry gives more efficiency over standard rasps. Cuts on pull stroke only. The rectangular end has 2 fine and 2 medium surfaces, triangular has 2 fine surfaces.

001021 Universal Sulcoplasty Rasp 210mm Long

Rectangular Sulcoplasty Instruments



A rectangular sulcoplasty retains the maximum articular cartilage. Most standard osteotomes are too thick, tending to break up the block. The super slim 8mm osteotome minimises breakup. The rectangular rasp is designed to tidy up the corners of the sulcoplasty to maximise 'fit'.

001017 Super Slim Osteotome 8mm 180mm

001018 Rectangular Bone Rasp 210mm

Trochlea Rasp



Designed for deepening the trochlea groove. For larger breeds perform a wedge or block trochleaplasty using a hard backed saw. An accurately contoured trochlea is essential for a successful trochleaplasty. Articular cartilage is removed to be replaced by fibrocartilage. Total length 190mm.

001020 Trochlea Rasp 11mm max 5mm Min Diameter

001022 Trochlea Rasp Small 8mm max 3mm Min Diameter

Osteophyte Rasp



Most stifles requiring cruciate repair will exhibit some osteophytes. In some cases they may be bulky, necessitating removal. The osteophyte rasp is a small yet very effective rasp to keep in the cruciate set.

001019 Osteophyte Rasp

Corrective Osteotomy Sawguide System



Corrective osteotomy is a recognised procedure in the management of patella luxation, particularly in medium and large dogs. Positioning the osteotomy at the CORA (centre of rotation) can be a challenge. Creating an accurate osteotomy at the site is a further challenge. The osteotomy and sawguide system allows the surgeon to create accurate osteotomies positioned at the correct site.

TTO011 Osteometer/Sawguide

TTO013 Saw Guide Attachment Forceps 9½" 245mm

Vi Locking TPO/DPO Plates

The Vi TPO/DPO plates are similar to, but have larger footprints than, the Slocum style plates. They are available in both 2.7mm and 3.5mm sizes. Both feature divergent stacked locking holes on cranial and caudal sections to maximise implant security and a compression hole on the cranial portion.



The 2.7mm plates have three screw holes cranially and caudally.

The 3.5mm plate has four holes cranially and three holes caudally.

09930320L	3.5mm TPO/DPO Locking Plate 20 Left
09930420R	3.5mm TPO/DPO Locking Plate 20 Right
09930525L	3.5mm TPO/DPO Locking Plate 25 Left
09930625R	3.5mm TPO/DPO Locking Plate 25 Right
09930730L	3.5mm TPO/DPO Locking Plate 30 Left
09930830R	3.5mm TPO/DPO Locking Plate 30 Right
09940320L	2.7mm TPO/DPO Locking Plate 20 Left
09940420R	2.7mm TPO/DPO Locking Plate 20 Right
09940525L	2.7mm TPO/DPO Locking Plate 25 Left
09940625R	2.7mm TPO/DPO Locking Plate 25 Right
09940730L	2.7mm TPO/DPO Locking Plate 30 Left
09940830R	2.7mm TPO/DPO Locking Plate 30 Right

XL Locking Drill Guides

Extra-long locking drill-guides simplify working in deeper spaces, especially useful for TPO/DPO.



LSDG2724XL	2.7mm Locking Screw Drill Guide - Extra Long
LSDG35XL	3.5mm Locking Screw Drill Guide - Extra Long 45mm
LSDG35XXL	3.5mm Locking Screw Drill Guide - XXL 60mm



Hip Toggle Procedure

The hip toggle procedure is a well-established technique for the management of traumatic and unstable subluxation of the the coxo-femoral joint. Although somewhat invasive, it does have the advantage that by replacing the round ligament the hip has, postoperatively, a full range of movement.

However, the suture is placed into a very hostile abrasive environment and historically had a high failure rate. Newer materials have, to a degree, addressed this problem. LigaFiba® is spun Ultra High Molecular Weight Polyethylene. This is the same high wear material used for acetabular cups in Total Hip Replacement. For any given diameter, LigaFiba® is 2.5x stronger than the traditional monofilament nylon. In addition, the softer more flexible nature of the material allows a relatively larger implant to be passed along bone tunnels. LigaFiba® has, in addition, better wear characteristics than nylon.

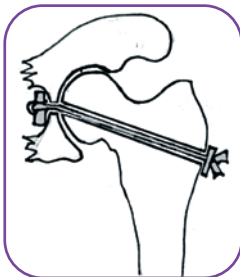

The Hip Toggle has an 'eye' to hold the suture and is made from stainless steel 316LVM. Use the Adjustable Drill Guide to accurately place the hole in the femoral neck.

All sterile packs contain a titanium button for secure fixation of the suture. Available with monofilament nylon or braided LigaFiba®. LigaFiba® is easier to work with, is stronger and ties better. However, it is a braided material with higher infection risk, so the surgeon must pay close attention to aseptic technique. We recommend the use of an anti-bacterial adhesive drape for hip toggle surgery.

LigaFiba® Hip Toggles



HIPTOGLF150TI	2mm Hip Toggle c/w 150 LigaFiba®, Titanium Button - Sterile
HIPTOGLF250TI	3mm Hip Toggle c/w 250 LigaFiba®, Titanium Button - Sterile
HIPTOGLF250MTI	2.5mm Hip Toggle c/w 250 LigaFiba®, Titanium Button - Sterile
HIPTOG-S	80lb Nylon c/w 3mm Hip Toggle & Titanium Button
HIPINTLF250	HIPTOGLF250TI c/w Introducer
HIPINT	3mm Hip Toggle 80lb Nylon & Ormrod Button
HIPTOGKITLF	Contains Introducer, Hip Toggle with 250 LigaFiba® Drill Guide 3.5 & 4.5mm Drills
ADJDG2035	Adjustable Drill Guide 2.0, 2.5, 3.5mm Drills
TOG	Hip Toggle Only 3.0mm (Non Sterile)
TOGM	Hip Toggle Only 2.5mm (Non Sterile)
TOGS	Hip Toggle Only 2.0mm (Non Sterile)
TIBUT6H	Titanium Button 6mm 2 Holes (Non Sterile)
TIBUT9H	Titanium Button 9mm 2 Holes (Non Sterile)
TIBUT11H	Titanium Button 11mm 2 Holes (Non Sterile)

Hip Toggle Introducer

Use of a dedicated introducer facilitates the introduction of the 3mm toggle through the acetabulum into the pelvis.

Please note, only the 3mm toggle has an introducer. An introducer is not appropriate for the smaller sizes of hip toggle as the hole drilled in the acetabulum would be proportionately too large to accommodate the introducer. An over-large hole in a smaller patient would risk iatrogenic acetabular fracture. The smaller hip toggles are therefore inserted using an artery forcep or similar.



Notes on the use of the Hip Toggle system

1. Expose femoral head and floor of acetabulum via a cranio-lateral approach. Perform a trochanteric osteotomy if necessary
2. Clear soft tissues (mostly shredded round ligament) from acetabulum and fovea of femoral head
3. Drill a hole through the acetabular fossa (effectively the origin of the round ligament). Drill size required
 - 3mm Toggle plus 250 LigaFiba® 4.5mm drill
 - 3mm Toggle plus 80lb Nylon 4.8mm drill
 - 2.5mm Toggle plus 250 LigaFiba® 4mm drill
 - 2mm Toggle plus 150 LigaFiba® 2.7mm drill

Points 4, 5 and 6 – please note that the insertion tool is only supplied for 3mm toggles. For toggles smaller than 3mm it is recommended to use a pair of artery forceps for insertion of the toggle.

4. Load the toggle into the insertion tool (3mm toggle only). The 'long' end goes into the inserter tip. The suture is retained onto the inserter shaft by sliding the silicone ring over the toggle and inserter
5. Push projecting toggle into hole in acetabulum
6. Insert plunger and eject toggle into pelvic canal. Toggle should 'flip' out preventing pull out. Check toggle security
7. Drill a bone tunnel (2.5-3.5mm) from fovea exiting from proximal lateral femur
 - a. Use Adjustable Drill Guide for best results (ADJDG2035)
 - b. Visually assess positioning/drill placement
 - c. Drill from fovea to femur (requires severe external rotation of femur)
8. Pass free suture ends down the femoral neck tunnel from fovea to femur. LigaFiba® will require a suture puller or alternatively a folded loop of fine cerclage wire may be passed from lateral to medial to exit at the fovea. Pass the LigaFiba® through the loop and pull back. Check there are no soft tissues (usually joint capsule) interposed between head and acetabulum
9. Pass ends of the suture through holes in titanium button, pull tight and tie temporarily. Check that coxo-femoral joint has a full range of movement. Tie securely over button. Over-tightening is a technical error and will result in premature failure of the suture

Note: The implant always breaks within a few weeks of placement regardless of technique and material. The toggle provides temporary stability only. If it becomes necessary to remove the suture, locate the titanium button and remove both button and suture. It is not possible to retrieve the toggle which, lying extra-articularly, does not cause a problem. Complications/failure with the Hip Toggle system may be higher in giant breed dogs.

Hohman Retractors

A simple but multi-functional instrument, with a wide number of variations to cover different procedures, patients and surgeons' requirements.

Hohman Retractors With Short Tips 18mm & 12mm Blades



001041

These are the archetypal Hohman Retractors often described in text-books as 'Hohman'.

The 'standard' Hohman retractor shape and size.

Larger version at 240mm long is useful in larger dogs over about 20kg where more force is required for manipulation, and there may be more depth of overlying tissue.

Smaller version, 175mm long, is scaled down and useful in slightly smaller dogs or in smaller bones where less force is needed. Good for retracting fascia lata in CrCl procedures.

001041 Hohman Retractor 18mm Short Narrow Tip Total Length 240mm

001042 Hohman Retractor 12mm Short Narrow Tip Total Length 175mm

Mini Hohman 6mm & 8mm Blade With Short Tip



Ideal for careful retraction of soft tissue during the manipulation of smaller bones and fragments, aiding reduction of soft tissue devascularisation. Also allows delicate retraction of soft tissue for screw and wire placement.

8mm version is particularly good for long bones in the cat.

001047 Mini Hohman Retractor 6mm Short Tip 165mm Long

001048 Mini Hohman Retractor 8mm Short Tip 165mm Long

Micro Hohman 4mm With Short Narrow Tip



The smallest Hohman that Vi supply. Useful in very small procedures or patients. Also available in a version with a long narrow shaft to use with arthroscopic portals.

001049 Micro Hohman Retractor 4mm Short Tip 160mm Long

001049A Micro Hohman Retractor 4mm Short Tip
With Narrow Shaft For Arthroscopy 160mm Long

Hohman Retractor Broad With Short Narrow Tip



001045

Broad blade Hohman provides more effective retraction of large muscle masses than the standard version, with less focal pressure.

001045 Hohman Retractor 48mm Short Narrow Tip 260mm Long

001046 Hohman Retractor 24mm Short Narrow Tip 185mm Long

Hohman Retractor With Long Broad Tip



001043

Useful in and around the shoulder joint and other retraction situations when a blunt tip is desirable.

001043 Hohman Retractor 24mm Long Broad Tip 280mm Long

001044 Hohman Retractor 18mm Long Broad Tip 175mm Long

Mini Hohman Broad Blade with Narrow Tip



Suggested uses: Improving visualisation of and access to mid-diaphysis of cat and small dog bones and displacing ligaments and tendons in carpus/tarsus of larger patients.

001040 Mini Hohman 15mm Broad Blade 120mm Long

Hip Hohman



Developed for use in Total Hip Replacement but useful in any procedure requiring elevation of the femoral head. Multiple small teeth at the end lip of the instrument sit securely on the femoral neck outside the zone of articular cartilage.

Three sizes are available. Approximate guidelines are as follows:

Large	>30kg
Medium	10-30kg
Small	<10kg

001038 Large Hip Hohman 255mm Long 25mm Wide Blade

001037 Medium Hip Hohman 175mm Long 13mm Wide Blade

001036 Small Hip Hohman 125mm Long 8mm Wide Blade

0010300SET Hip Hohman Set of 3 (As above)

OCD Curette



Loose flaps of cartilage at the OCD lesion must be removed. The double ended OCD curette is designed to perform this task within the limited space available. Healthy fibrocartilage within the lesion should not be disturbed.

- 001030 OCD Curette 215mm Long
- 001032 OCD Curette Small 180mm Long

Combination Bone Rasp Set



The three interchangeable rasp blades offer a range of cutting surfaces, flat, round and 'putti' style. The handle has an ergonomic design which is easy to grip even when wet.

- 001015 Combination Bone Rasp With 3 Interchangeable Heads

Gigli



- 001514 Pair of Handles For Gigli Wire
- 001516 Gigli Saw 300mm
- 001517 Gigli Saw 500mm
- 001518 Gigli Wire Passer
- 001519 Gigli Wire Spool 10m



- 001515 Pair of Gigli Saw Handles

Goniometers

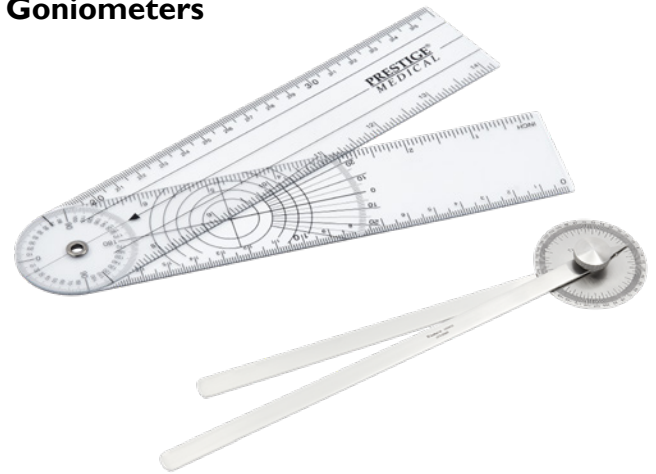

- HE-GONIO Femoral Neck Goniometer
- GONIO Goniometer 150mm
- GONIO2 Goniometer 300mm
- GONIO3 Goniometer 340mm

Femoral Head & Neck Excision Arthroplasty

Excision Arthroplasty Rasp



Designed specifically to remove any bone spurs following excision arthroplasty. Failure to remove bone spurs is the most common cause of problems with this procedure. Teeth cut on the back stroke.

001010 Excision Arthroplasty Rasp 170mm Long

Disarticulator



Disarticulator designed to elevate the femoral head for excision. Notch at the tip of the instrument engages and ruptures the Teres (round) ligament, which can be very difficult. Also useful in manipulation for the humeral head in OCD lesion procedures and investigation of elbow lesions.

001090 Small Disarticulator 145mm Long
001091 Large Disarticulator 195mm Long

Hatt Spoon



Alternative to the 'chip fork' style disarticulator, particularly for larger dogs. Spoon edge is sharp. Good-sized handle with a finer shaft for better balance.

001092 Hatt Spoon 230mm (17mm x 30mm Scoop)
001093 Hatt Spoon 230mm (12mm x 18mm Scoop)
001094 Hatt Spoon 230mm (7mm x 12mm Scoop)
00109SET Hatt Spoon Set of 3 (As above)



Training & Education

Our e-learning platform delivers a variety of technical and clinical educational material, in an engaging and interactive format.

With a CPD certificate awarded upon successful completion of each module, the e-learning platform from Vi will help you to fulfil your annual CPD requirements.

Sign up today by scanning the QR code below.



Arthroscopic Instrumentation

Arthroscopy Hand Instrument Set



Set of three arthroscopy instruments for examination and intra-articular surgery. The two hand held knives can deal with most meniscal tears, whilst the black shaft of the hook probe minimises reflection.

Arthroscopy Set Contains:

AR-17-19X

AR-17-11X

AR-17-10

- AR-17-SET** Arthroscopy Hand Instrument Set
AR-17-19X Meniscus Hook Knife Blade Knurled Stainless Handle
AR-17-19XS 3mm Meniscus Hook Knife Blade Knurled Stainless Handle 150mm
AR-17-11X Push Knife
AR-17-10 Hook Probe 2.2mm, With Stainless Handle Black Shaft

External Stifle Distractor



Developed originally for arthroscopic use but also useful in open surgery on very tight osteoarthritic stifles. Improves visibility in the joint by reducing clutter.

- AR-17-01** Arthroscopic Distractor 2.5mm Pins 80mm
AR-17-01/TPLO Arthroscopic Distractor 3.2mm Pins 80mm

Arthroscopic Stifle Lever VSTL



The arthroscopic stifle lever is finer and longer than the standard version, making it more suitable for arthroscopic surgery.

The good-sized white PTFE handle has a useful notch which aligns with the tip orientation of the lever. Not just for arthroscopy – useful in open arthrotomies as well.

Developed for stifle surgery by Ian Holsworth.

- AR-17-02** Arthroscopic Stifle Lever VSTL 280mm

Arthroscopic Hand Instruments

Hook Probe



- AR-17-09S** Hook Probe 2.2mm With Silicon Handle

Banana Knife



- AR-17-05S** Banana Knife 2.7mm, with Silicon Handle

Curette



- AR-17-06S** Curette 2.7mm Curved With Silicon Handle

Ring Curette



- AR-17-07S** Ring Curette 2.7mm Small With Silicon Handle

Smilie Knife



- AR-17-11S** Smilie Knife 2.7mm With Silicon Handle

Hook Knife



- AR-17-19S** Hook Knife 2.7mm With Silicon Handle

Arthroscopic Hohman Retractor



001049A Arthroscopic Hohman 4mm

Milling Drill Designed by Van Ryssen & Van Bree



This hand-driven bur allows curettage of both cartilage and bone through the smallest working cannula. Much cheaper and easier than shaver systems.

I-17-822 Milling Drill For Arthroscopy Complete OD: 2.2mm WL: 12cm
I-17-821 Replacement Bur & Shaft

Gordon Coronoid Osteotome



Designed and developed by Ian Holsworth, this narrow osteotome is used for arthroscopic sub-total coronoidectomies.

AR-17-30 Gordon Coronoid Osteotome 4mm
AR-17-29 Gordon Coronoid Osteotome 2mm

2.7mm Instruments

2.7mm Instruments - working length 12cm with overstraining protection.

Alligator Grasping Forceps



AS-17-662 Alligator Grasping Forceps With Ratchet OD: 2.7mm

Universal Rongeur & Grasping Forceps



AS-17-632 Universal Rongeur & Grasping Forceps Fenestrated OD: 2.7mm

Biopsy & Spoon



AS-17-641 Biopsy & Spoon OD: 2.7mm

Shoulder Aiming Device

Developed and tested at the Veterinary Faculty of Vienna, Austria by Dr Lehman.



Due to the dense muscle mass in shoulder joints, creating a puncture for a working cannula is often quite difficult. If a clean puncture allowing access directly to the joint is not achieved the first time, the risk of a subsynovial oedema increases greatly.

The shoulder puncture system has been specifically designed to help eliminate this risk.

S140-2438F Aiming Device By Dr Lehman For The Canine Shoulder For 2.4mm Scope T140-2432 & Changing Rod I-17-028

Cannula Sets



I-17-755 Working Cannula Set 'Shoulder & Elbow' Designed By VAN BREE D:2.3 / 2.9 / 3.5mm; WL:3.5-5cm & 7-8 cm, Includes Sharp Trochar & Changing Rod

I-17-500 Working Cannula Set 'elbow' Designed By VAN BREE Consist of 3 Cannulas D:2.3/2.9/3.5mm; WL:3.5-5cm. Includes 1 Sharp Trochar & 1 Changing Rod (2.3mm)



I-18-518 Egress Cannula, With Sharp Trochar Stopcock ID 2.7mm WL 7cm

Hand Pressure Infusion Cuffs



AR-08-100 Pressure Infusion Cuff For 500-1000ml Complete With Pressure Gauge & Hand Pump Reusable

Puddle Vac



PV9321 Puddle Vac Pack of 5

Camera Covers

DE-10-25 Camera Cover Disp Polyethylene 13 x 235cm Sterile Pack of 30
DE-10-25-SINGLE Single Camera Cover Disposable 13 x 235cm Sterile

HELICA

Surgeons contemplating use of the Helica system must attend a recognised training course.

Helica Total Hip Instrumentation



HE-KIT Helica Instrument Kit

Ancillary Helica Instrumentation

Three instruments, not included in the standard sets, make osteotomy and alignment of the femoral stem significantly easier and are recommended. The Meyerding is a very powerful hand-held retractor.

Refer to page 70 for Hip Hohman. The goniometer helps the surgeon to establish the correct axis for the femoral stem at an angle of 145 to 147 degrees.



- 001038** Helica Hohman Large
- 001037** Helica Hohman Medium
- 001036** Helica Hohman Small
- 0010300SET** Helica Hohman Set of 3 (As above)
- HE-GONIO** Helica Goniometer
- I50019** Meyerding Retractor

Helica Drill Guide



This drill guide was modified by Christoph Stork, DipECVS, as an aid to drilling of the femoral neck during the Helica total hip joint replacement. In essence, this is an over-sized soft-tissue protector with a very large bore of 9mm accepting the largest of the drill-bits used in this procedure.

HELICADG Helica Drill Guide 9mm Diameter Bore

Helica Total Hip Implants

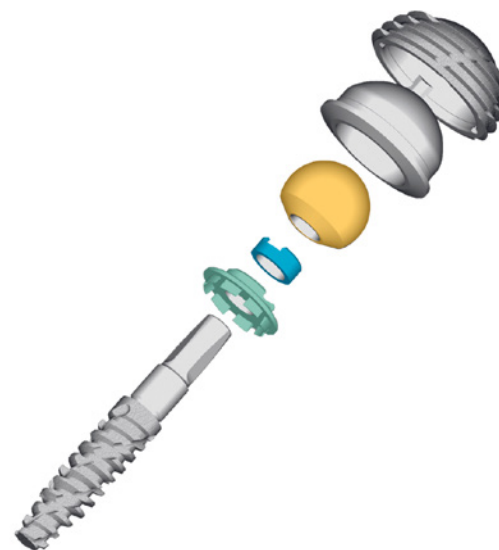

Helica Screw Acetabular Cups

- HE-HCI-T22** Helica 22mm Acetabular Cup
- HE-HCI-T26** Helica 26mm Acetabular Cup
- HE-HCI-T28** Helica 28mm Acetabular Cup
- HE-HCI-T30** Helica 30mm Acetabular Cup
- HE-HCI-T32** Helica 32mm Acetabular Cup

Helica TPS Stems

- HE-HS4-T0831** Helica TPS SL Stem 8x31mm
- HE-HS4-T0932** Helica TPS SL Stem 9x32mm
- HE-HS4-T1035** Helica TPS SL Stem 10x35mm
- HE-HS4-T1137** Helica TPS SL Stem 11x37mm
- HE-HS4-T-11X41** Helica TPS SL Stem, Titan 11x41mm
- HE-HS4-T1239** Helica TPS SL Stem 12x39mm

Helica TPS Flanges

HE-HF3-T18.5	Helica TPS Flange and Locking Nut 18.5mm
HE-HF3-T20	Helica TPS Flange and Locking Nut 20.0mm
HE-HF3-T22	Helica TPS Flange and Locking Nut 21.5mm

Helica TPS Locking Nut

HE-HN3-T08	TPS Helica Locking Nut (For Replacement)
-------------------	--

Helica Femoral Heads

HE-FHI-18S	Helica 18mm Femoral Head - Short
HE-FHI-18M	Helica 18mm Femoral Head - Medium
HE-FHI-18L	Helica 18mm Femoral Head - Long
HE-FHI-18XL	Helica 18mm Femoral Head - Extra Long
HE-FHI-18XXL	Helica 18mm Femoral Head - XX Long



Inlay Options for Screw Cup

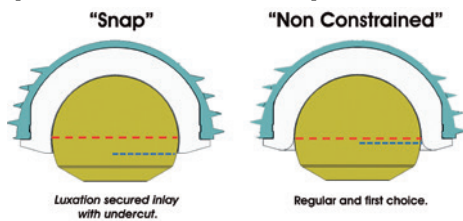

The standard inlay for the screw cup for use with Helica stems is non-constrained. Certain cases which for reasons of conformation or soft tissue benefit from a 'Snap Inlay' which is retentive.

Helica Inlays Constrained

HE-ALI-P24	Helica 24mm Inlay
HE-ALI-P26	Helica 26mm Inlay
HE-ALI-P28	Helica 28mm Inlay
HE-ALI-P30	Helica 30mm Inlay
HE-ALI-P32	Helica 32mm Inlay

Helica Inlays Non-Constrained

HE-ALI-P22	Helica 22mm Inlay Non Constrained
HE-ALI-P24-NC	Helica 24mm Inlay Non Constrained
HE-ALI-P26-NC	Helica 26mm Inlay Non Constrained
HE-ALI-P28-NC	Helica 28mm Inlay Non Constrained
HE-ALI-P30-NC	Helica 30mm Inlay Non Constrained

Helica Hybrid Revision Implants

HE-FHB-18-0	Helica Hybrid 18mm Femoral Head Biometric Shank + 0
HE-FHB-18-3	Helica Hybrid 18mm Femoral Head Biometric Shank + 3
HE-FHB-18-6	Helica Hybrid 18mm Femoral Head Biometric Shank + 6
HE-FHK-18XS	Helica Hybrid 18mm Femoral Head Kyon Extra Short
HE-FHK-18S	Helica Hybrid 18mm Femoral Head Kyon Short
HE-FHK-18M	Helica Hybrid 18mm Femoral Head Kyon Medium
HE-FHK-18L	Helica Hybrid 18mm Femoral Head Kyon Long
HE-FHK-18XL	Helica Hybrid 18mm Femoral Head Kyon Extra Long

3CON Stems

TSI-C-04	3CON Stem # 4
TSI-C-05	3CON Stem # 5
TSI-C-06	3CON Stem # 6
HE-TSI-C-07	3CON Stem # 7

CemtA Stems

HE-CS1-C-04	CemtA Stem	#4
HE-CS1-C-05	CemtA Stem	#5
HE-CS1-C-06	CemtA Stem	#6
HE-CS1-C-07	CemtA Stem	#7
HE-CS1-C-08	CemtA Stem	#8

CemtA Cups

HE-CCI-P-21	CemtA Cup 21mm
HE-CCI-P-23	CemtA Cup 23mm
HE-CCI-P-25	CemtA Cup 25mm
HE-CCI-P-27	CemtA Cup 27mm
HE-CCI-P-29	CemtA Cup 29mm

15mm Femoral Heads

HE-FHI-S-15-S	15mm Femoral Head Small
HE-FHI-S-15-M	15mm Femoral Head Medium
HE-FHI-S-15-L	15mm Femoral Head Large
HE-FHI-S-15-XL	15mm Femoral Head Extra Large
HE-FHI-S15-XXL	15mm Femoral Head Extra Extra Large

Cement Restrictor

HE-CRI-P-01	Cement Restrictor Size 1
HE-CRI-P-02	Cement Restrictor Size 2

Hip Fixation & Navigation Device

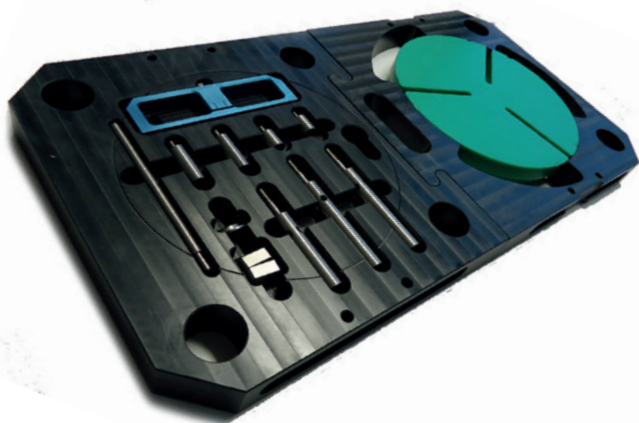

During Total Hip Replacement procedure, correct placement of the acetabular cup is essential. This navigation device gently positions the patient and includes an orientation guide to ensure the correct inclination and retroversion angles are maintained. The blue handle allows easy rotation of the table to aid comfortable positioning, reducing the risk of stress on the spine.

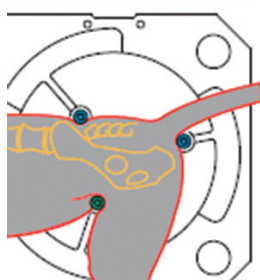

Construction is of titanium and high-strength aluminium, for easy cleaning and maintenance. When not in use, the table can be disassembled for storage. The two halves of the table feature slots for all components, clipping together for secure storage between uses.

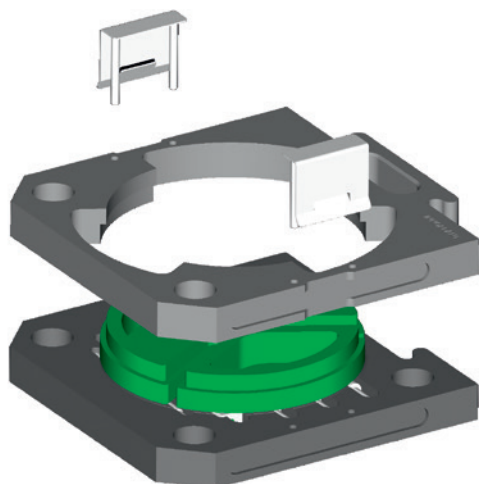
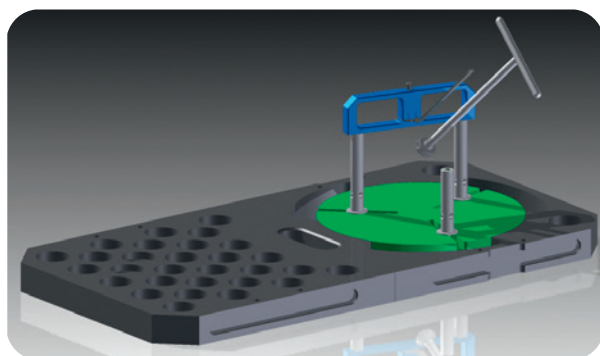

HE-HFN-KS-01 Hip Fixation & Navigation Device

Bone Cement

DePuy CMW Bone Cement

Designed for Total Hip Replacement. CMW is the industry standard. Also useful in stabilisation of vertebral fractures/luxations.

CMW1 is a medium/high viscosity cement for digital application. CMW2 is a rapid set cement suitable for the acetabular cup via digital application.

CMW3 is a more fluid cement which is more appropriate for the femoral component. It is usually applied via a 50ml syringe.

CMW cement comes impregnated with Gentamycin which minimises post operative infection.



- 160500 CMW1 With Gentamycin 20g
- 160501 CMW2 With Gentamycin 20g
- 160503 CMW3 With Gentamycin 20g
- 160504 CMW3 With Gentamycin 40g

Veterinary Instrumentation Bone Cement



- BC1 High Viscosity 20g
- BC1G High Viscosity 20g With Gentamycin
- BC3G Low Viscosity (Syringe) 20g With Gentamycin

Internal Fixation



To view the Internal Fixation section of our website, please scan the QR code.



SurgX FABRICANT
D'IMPLANTS
VÉTÉRINAIRES

Exclusively available at



Veterinary
Instrumentation

We are delighted to introduce our exclusive partnership with Surg'X.

Surg'X offers the first angle-stable, anatomical titanium veterinary interlocking nail for the treatment of long bone fractures in small animals. Interlocking nails are the gold standard in human long-bone trauma, thanks to their biological and mechanical advantages over plates.

Implant and Instrument Sets

Cats and Small Dogs - Implant Set

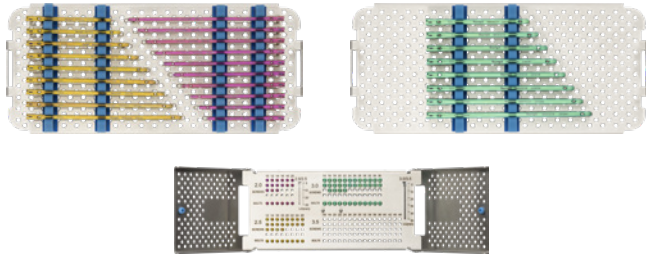

Image for illustration purposes only. Correct contents of kit shown below:

The Cats and Small Dogs Implant Set includes:

- 18 most commonly used nail sizes
- 63 locking screws (2 to 3 per size)
- 26 bolts (1 per size)
- 3 sterilization containers, 2 modular trays and 1 screw rack

SXIS000110 Surg'X Interlocking Nail Small Starter Implant Set

Cats and Small Dogs - Instrument Set

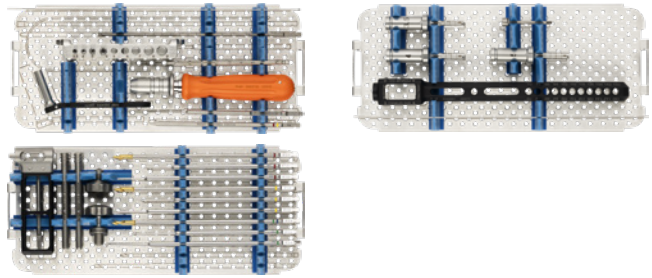

The Cats and Small Dogs Instrument Set includes:

- 41 Instruments for nails 3.5 / 4 / 5
- 2 common instrument trays
- 1 Cats and Small Dogs instrument tray
- 2 sterilization containers

SXAS000120 Surg'X Small Instrument Set

Medium and Large Dogs - Implant Set

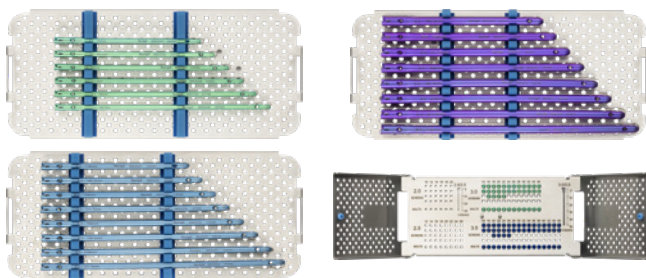

Image for illustration purposes only. Correct contents of kit shown below:

The Medium and Large Dogs Implant Set includes:

- 13 most commonly used nail sizes
- 64 locking screws (2 to 3 per size)
- 28 bolts (1 per size)
- 4 sterilization containers, 3 modular trays and 1 screw rack

SXIS000210 Surg'X Interlocking Nail Med/Large Starter Implant Set

Medium and Large Dogs - Instrument Set

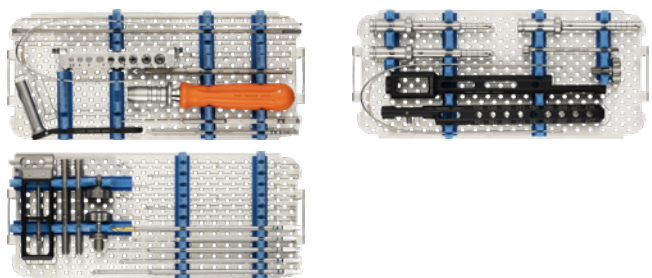

The Medium and Large Dogs Instrument Set includes:

- 37 Instruments for nails
- 2 Common instrument trays
- 1 Medium and Large Dogs instrument tray
- 2 sterilization containers

SXAS000220 Surg'X Med/Large Instrument Set

Cats and Dogs All Sizes - Implant Set

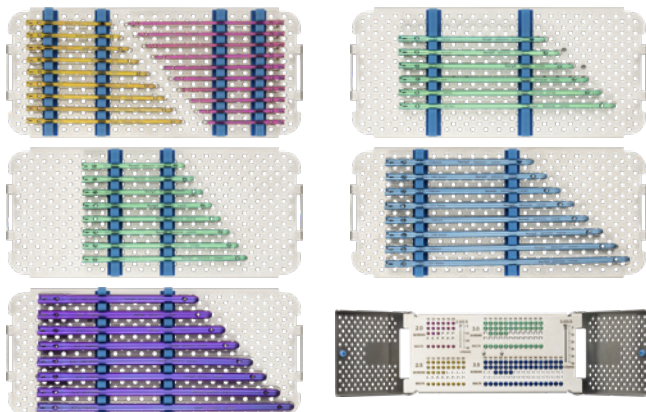

Image for illustration purposes only. Correct contents of kit shown below:

The Cats and Dogs All Sizes Implant Set includes:

- 29 most commonly used nail sizes
- 99 locking screws (2 to 3 per size)
- 42 bolts (1 per size)
- 6 sterilization containers, 5 modular trays and 1 screw rack

SXIS000310 Surg'X Interlocking Nail All Size Starter Implant Set

Cats and Dogs All Sizes - Instrument Set

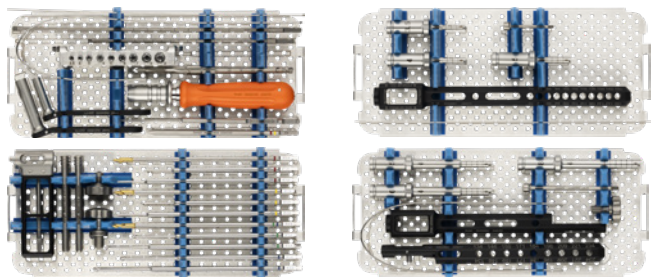

The Cats and Dogs All Sizes Instrument Set includes:

- 61 Instruments for nails
- 2 Common instrument trays
- 1 Cats and Small Dogs instrument tray
- 1 Medium and Large Dogs instrument tray
- 3 sterilization containers

SXAS000310 Surg'X All Size Instrument Set

Interlocking Nails

3.5mm Interlocking Nail



This nail is suitable for cats and small dogs.

SXIN35070	3.5mm Interlocking Nail 70mm
SXIN35078	3.5mm Interlocking Nail 78mm
SXIN35086	3.5mm Interlocking Nail 86mm
SXIN35094	3.5mm Interlocking Nail 94mm
SXIN35102	3.5mm Interlocking Nail 102mm
SXIN35110	3.5mm Interlocking Nail 110mm
SXIN35118	3.5mm Interlocking Nail 118mm
SXIN35126	3.5mm Interlocking Nail 126mm
SXIN35134	3.5mm Interlocking Nail 134mm
SXIN35142	3.5mm Interlocking Nail 142mm

5mm Interlocking Nail

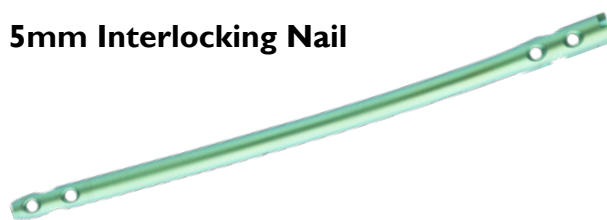

The Short 5mm nail is suitable for cats and small dogs, with the longer 5mm nails suitable for medium and large dogs.

SXIN50094S	5mm Interlocking Nail Short 94mm
SXIN50102S	5mm Interlocking Nail Short 102mm
SXIN50110S	5mm Interlocking Nail Short 110mm
SXIN50118S	5mm Interlocking Nail Short 118mm
SXIN50126S	5mm Interlocking Nail Short 126mm
SXIN50134S	5mm Interlocking Nail Short 134mm
SXIN50142S	5mm Interlocking Nail Short 142mm
SXIN50150S	5mm Interlocking Nail Short 150mm
SXIN50134	5mm Interlocking Nail 134mm
SXIN50146	5mm Interlocking Nail 146.5mm
SXIN50159	5mm Interlocking Nail 159mm
SXIN50171	5mm Interlocking Nail 171.5mm
SXIN50184	5mm Interlocking Nail 184mm
SXIN50196	5mm Interlocking Nail 196.5mm

4mm Interlocking Nail



This nail is suitable for cats and small dogs.

SXIN40078	4mm Interlocking Nail 78mm
SXIN40086	4mm Interlocking Nail 86mm
SXIN40094	4mm Interlocking Nail 94mm
SXIN40102	4mm Interlocking Nail 102mm
SXIN40110	4mm Interlocking Nail 110mm
SXIN40118	4mm Interlocking Nail 118mm
SXIN40126	4mm Interlocking Nail 126mm
SXIN40134	4mm Interlocking Nail 134mm
SXIN40142	4mm Interlocking Nail 142mm

6mm Interlocking Nail



This nail is suitable for medium and large dogs.

SXIN60134	6mm Interlocking Nail 134mm
SXIN60146	6mm Interlocking Nail 146.5mm
SXIN60159	6mm Interlocking Nail 159mm
SXIN60171	6mm Interlocking Nail 171.5mm
SXIN60184	6mm Interlocking Nail 184mm
SXIN60196	6mm Interlocking Nail 196.5mm
SXIN60209	6mm Interlocking Nail 209mm
SXIN60221	6mm Interlocking Nail 221.5mm

8mm Interlocking Nail



This nail is suitable for medium and large dogs.

SXIN80146	8mm Interlocking Nail 146.5mm
SXIN80159	8mm Interlocking Nail 159mm
SXIN80171	8mm Interlocking Nail 171.5mm
SXIN80184	8mm Interlocking Nail 184mm
SXIN80196	8mm Interlocking Nail 196.5mm
SXIN80209	8mm Interlocking Nail 209mm
SXIN80221	8mm Interlocking Nail 221.5mm
SXIN80234	8mm Interlocking Nail 234mm

Acetates are available to download from Vi website.
These must be printed to scale.

Interlocking Screws

2mm Interlocking Screw

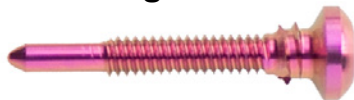

Compatible with 3.5mm Interlocking Nail

SXSC2010	2mm Interlocking Screw 10mm
SXSC2012	2mm Interlocking Screw 12mm
SXSC2014	2mm Interlocking Screw 14mm
SXSC2016	2mm Interlocking Screw 16mm
SXSC2018	2mm Interlocking Screw 18mm
SXSC2020	2mm Interlocking Screw 20mm

2.5mm Interlocking Screw



Compatible with 4.0mm Interlocking Nail

SXSC2512	2.5mm Interlocking Screw 12mm
SXSC2514	2.5mm Interlocking Screw 14mm
SXSC2516	2.5mm Interlocking Screw 16mm
SXSC2518	2.5mm Interlocking Screw 18mm
SXSC2520	2.5mm Interlocking Screw 20mm
SXSC2522	2.5mm Interlocking Screw 22mm
SXSC2524	2.5mm Interlocking Screw 24mm
SXSC2526	2.5mm Interlocking Screw 26mm

3mm Interlocking Screw

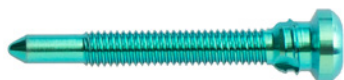

Compatible with 5.0mm Interlocking Nail

SXSC3014	3mm Interlocking Screw 14mm
SXSC3016	3mm Interlocking Screw 16mm
SXSC3018	3mm Interlocking Screw 18mm
SXSC3020	3mm Interlocking Screw 20mm
SXSC3022	3mm Interlocking Screw 22mm
SXSC3024	3mm Interlocking Screw 24mm
SXSC3026	3mm Interlocking Screw 26mm
SXSC3028	3mm Interlocking Screw 28mm
SXSC3030	3mm Interlocking Screw 30mm
SXSC3032	3mm Interlocking Screw 32mm
SXSC3034	3mm Interlocking Screw 34mm
SXSC3036	3mm Interlocking Screw 36mm

3.5mm Interlocking Screw



Compatible with 6.0/8.0mm Interlocking Nail

SXSC3516	3.5mm Interlocking Screw 16mm
SXSC3518	3.5mm Interlocking Screw 18mm
SXSC3520	3.5mm Interlocking Screw 20mm
SXSC3522	3.5mm Interlocking Screw 22mm
SXSC3524	3.5mm Interlocking Screw 24mm
SXSC3526	3.5mm Interlocking Screw 26mm
SXSC3528	3.5mm Interlocking Screw 28mm
SXSC3530	3.5mm Interlocking Screw 30mm
SXSC3532	3.5mm Interlocking Screw 32mm
SXSC3534	3.5mm Interlocking Screw 34mm
SXSC3536	3.5mm Interlocking Screw 36mm
SXSC3538	3.5mm Interlocking Screw 38mm
SXSC3540	3.5mm Interlocking Screw 40mm
SXSC3542	3.5mm Interlocking Screw 42mm
SXSC3545	3.5mm Interlocking Screw 45mm
SXSC3548	3.5mm Interlocking Screw 48mm

Interlocking Bolts

2mm Interlocking Bolt



Compatible with 3.5mm Interlocking Nail

SXB2010	2mm Interlocking Bolt 10mm
SXB2012	2mm Interlocking Bolt 12mm
SXB2014	2mm Interlocking Bolt 14mm
SXB2016	2mm Interlocking Bolt 16mm
SXB2018	2mm Interlocking Bolt 18mm
SXB2020	2mm Interlocking Bolt 20mm

2.5mm Interlocking Bolt



Compatible with 4.0mm Interlocking Nail

SXB2512	2.5mm Interlocking Bolt 12mm
SXB2514	2.5mm Interlocking Bolt 14mm
SXB2516	2.5mm Interlocking Bolt 16mm
SXB2518	2.5mm Interlocking Bolt 18mm
SXB2520	2.5mm Interlocking Bolt 20mm
SXB2522	2.5mm Interlocking Bolt 22mm
SXB2524	2.5mm Interlocking Bolt 24mm
SXB2526	2.5mm Interlocking Bolt 26mm

3mm Interlocking Bolt



Compatible with 5.0mm Interlocking Nail

SXB3014	3mm Interlocking Bolt 14mm
SXB3016	3mm Interlocking Bolt 16mm
SXB3018	3mm Interlocking Bolt 18mm
SXB3020	3mm Interlocking Bolt 20mm
SXB3022	3mm Interlocking Bolt 22mm
SXB3024	3mm Interlocking Bolt 24mm
SXB3026	3mm Interlocking Bolt 26mm
SXB3028	3mm Interlocking Bolt 28mm
SXB3030	3mm Interlocking Bolt 30mm
SXB3032	3mm Interlocking Bolt 32mm
SXB3034	3mm Interlocking Bolt 34mm
SXB3036	3mm Interlocking Bolt 36mm

3.5mm Interlocking Bolt



Compatible with 6.0/8.0mm Interlocking Nail

SXB3516	3.5mm Interlocking Bolt 16mm
SXB3518	3.5mm Interlocking Bolt 18mm
SXB3520	3.5mm Interlocking Bolt 20mm
SXB3522	3.5mm Interlocking Bolt 22mm
SXB3524	3.5mm Interlocking Bolt 24mm
SXB3526	3.5mm Interlocking Bolt 26mm
SXB3528	3.5mm Interlocking Bolt 28mm
SXB3530	3.5mm Interlocking Bolt 30mm
SXB3532	3.5mm Interlocking Bolt 32mm
SXB3534	3.5mm Interlocking Bolt 34mm
SXB3536	3.5mm Interlocking Bolt 36mm
SXB3538	3.5mm Interlocking Bolt 38mm
SXB3540	3.5mm Interlocking Bolt 40mm
SXB3542	3.5mm Interlocking Bolt 42mm
SXB3545	3.5mm Interlocking Bolt 45mm
SXB3548	3.5mm Interlocking Bolt 48mm

Drill Bits

Surgical Drill Bit CIS-Cortex



- SXDB24C** Surg'X Drill Bit Red Band CIS-Cortex 2.4mm
- SXDB3C** Surg'X Drill Bit Yellow Band CIS-Cortex 3mm
- SXDB4C** Surg'X Drill Bit Green & Blue Band CIS-Cortex 4mm

Surgical Drill Bit TRANS-Cortex



- SXDB15T1** Surg'X Drill Bit Red Band TRANS-Cortex 1.5mm Size 1
- SXDB15T2** Surg'X Drill Bit Red Band TRANS-Cortex 1.5mm Size 2
- SXDB2T1** Surg'X Drill Bit Yellow Band TRANS-Cortex 2mm Size 1
- SXDB2T2** Surg'X Drill Bit Yellow Band TRANS-Cortex 2mm Size 2
- SXDB24T1** Surg'X Drill Bit Green Band TRANS-Cortex 2.4mm Size 1
- SXDB24T2** Surg'X Drill Bit Green Band TRANS-Cortex 2.4mm Size 2
- SXDB28T1** Surg'X Drill Bit Green Band TRANS-Cortex 2.8mm Size 1
- SXDB28T2** Surg'X Drill Bit Green Band TRANS-Cortex 2.8mm Size 2

SurgX FABRICANT
D'IMPLANTS
VÉTÉRINAIRES



Loan Kits

For a nominal fee, we have a range of **specialist loan kits** available to complement your own fleet. With next working day availability, the service offers flexibility as procedures are booked with your clients.

To find out more, scan the QR code below.



Plating Kits In Modular Plating Box (MPB) Concept

To view our Surgery Guide on 'The Essentials of Fracture Management' please scan the QR code below.



Locking Plate & Screw Kit



Our MPB locking kits contain plates, screws and required instrumentation.

- LS15STARDLPKITALLMPB** 1.5mm Locking Screw Star Head & DLP Plate Kit in MPB
- LS20STARDLPKITALLMPB** 2.0mm Locking Screw Star Head & DLP Plate Kit in MPB
- LS24STARDLPKITALLMPB** 2.4mm Locking Screw Star Head & DLP Plate Kit in MPB
- LS27STARDLPKITALLMPB** 2.7mm Locking Screw Star Head & DLP Plate Kit in MPB
- LS35STARDLPKITALLMPB** 3.5mm Locking Screw Star Head & DLP Plate Kit in MPB

Combined Dynamic Locking Plate Kits



Our combined DLP kits contain the most popular size combinations of DLP plates and combined screw caddies, which includes both star drive locking and star drive cortical screws.

- DLP15KIT-MPB** DLP Plating Kit 1.5 Mix Star Lock & Cort Screw Caddies
- DLP1520-MPB** DLP Plating Kit 1.5/2.0 Mix Star Lock & Cort Screw Caddies
- DLP152024KIT-MPB** DLP Plating Kit 1.5/2.0/2.4 Mix Star Lock & Cort Screw Caddies
- DLP2024KIT-MPB** DLP Plating Kit 2.0/2.4 Mix Star Lock & Cort Screw Caddies
- DLP2735KIT-MPB** DLP Plating Kit 2.7/3.5 Mix Star Lock & Cort Screw Caddies

Star Drive Cortical SelfTapping Kits



- CORTSTPKITSTAR152024MPB** 1.5/2.4mm Complete Self Tapping Star Drive Screw Cortical Kit
- CORTSTPKITSTAR27/35MPB** 2.7/3.5mm Complete Self Tapping Star Drive Screw Cortical Kit

Hex Head Cortical SelfTapping Kits



Our MPB self tapping cortical kits contain plates, screws and required instrumentation.

- CORTSTPI52024MPB** 1.5/2.0/2.4mm Self Tapping Cortical Kit In MPB
- CORTSTP2735MPB** 2.7/3.5mm Self Tapping Cortical Kit In MPB
- CORTSTKIT4.5MPB** 4.5mm Self Tapping Cortical Kit In MPB

Locking Screw Sets



Star drive locking screw sets in modular plating box screw caddy.

- LS15STARKITMPB** 1.5 Star Drive Locking Screw Set
- LS20STARKITMPB** 2.0 Star Drive Locking Screw Set
- LS24STARKITMPB** 2.4 Star Drive Locking Screw Set
- LS27STARKITMPB** 2.7 Star Drive Locking Screw Set
- LS35STARKITMPB** 3.5 Star Drive Locking Screw Set

Combined Screw Sets

The screw caddies contain both star drive locking and star drive cortical screws.

- MPBSC15-MIX** 1.5mm Screw Caddy With Star Drive Locking & Cortical Screws
- MPBSC20-MIX** 2.0mm Screw Caddy With Star Drive Locking & Cortical Screws
- MPBSC24-MIX** 2.4mm Screw Caddy With Star Drive Locking & Cortical Screws
- MPBSC27-MIX** 2.7mm Screw Caddy With Star Drive Locking & Cortical Screws
- MPBSC35-MIX** 3.5mm Screw Caddy With Star Drive Locking & Cortical Screws

Cortical Screw Sets

Star drive cortical screw sets in modular plating box screw caddy.

- MPBSC15-SDCS** 1.5mm Screw Caddy With Star Drive Cortical Screws
- MPBSC20-SDCS** 2.0mm Screw Caddy With Star Drive Cortical Screws
- MPBSC24-SDCS** 2.4mm Screw Caddy With Star Drive Cortical Screws
- MPBSC27-SDCS** 2.7mm Screw Caddy With Star Drive Cortical Screws
- MPBSC35-SDCS** 3.5mm Screw Caddy With Star Drive Cortical Screws

Hex drive cortical self tapping screw sets in modular plating box screw caddy.

- MPBSC15-CSST** 1.5mm Screw Caddy With Self Tap Cortical Screws
- MPBSC20-CSST** 2.0mm Screw Caddy With Self Tap Cortical Screws
- MPBSC24-CSST** 2.4mm Screw Caddy With Self Tap Cortical Screws
- MPBSC27-CSST** 2.7mm Screw Caddy With Self Tap Cortical Screws
- MPBSC35-CSST** 3.5mm Screw Caddy With Self Tap Cortical Screws

Full kit lists are available upon request.

Modular Plating Box Components Modular Plating Box Base & Lid



MPBB Modular Plating Box Base
MPBL Modular Plating Box Lid

Modular Plating Box Plate Trays For Locking Plates

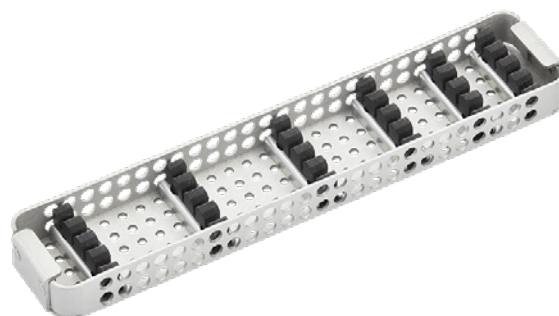

MPBPTL15 1.5mm MPB Plate Tray For Locking Plates
MPBPTL2 2.0mm MPB Plate Tray For Locking Plates
MPBPTL24 2.4mm MPB Plate Tray For Locking Plates
MPBPTL2735 2.7/3.5mm MPB Plate Tray For Locking Plates

Modular Plating Box Instrument Trays



MPBIT1520 1.5/2.0mm MPB Instrument Tray
MPBIT24 2.4mm MPB Instrument Tray
MPBIT2735I 2.7/3.5mm MPB Instrument Tray 1
MPBIT27352 2.7/3.5mm MPB Instrument Tray 2
MPBIT45 4.5mm MPB Combined Instrument & Plate Tray

Modular Plating Box Screw Caddies



MPBSC15 1.5mm MPB Screw Caddy
MPBSC20 2.0mm MPB Screw Caddy
MPBSC24 2.4mm MPB Screw Caddy
MPBSC27 2.7mm MPB Screw Caddy
MPBSC35 3.5mm MPB Screw Caddy
MPBSC45 4.5mm MPB Screw Caddy

Modular Plating Box TPLO Instrument Trays

MPBITTPLO1 Instrument Tray 1 For TPLO Kits
MPBITTPLO2 Instrument Tray 2 For TPLO Kits
MPBITTPLO3 Instrument Tray 3 For TPLO Kits

Dynamic Locking Plate Kits In Premium Box



Kit featured is LS24STARDLPKITALL

Our locking kits in anodised aluminium premium box contain plates, screws and required instrumentation.

- LS15STARDLPKITALL** 1.5mm Locking Screw Star Head & DLP Plate Kit in Prem Box
- LS20STARDLPKITALL** 2.0mm Locking Screw Star Head & DLP Plate Kit in Prem Box
- LS24STARDLPKITALL** 2.4mm Locking Screw Star Head & DLP Plate Kit in Prem Box
- LS27STARDLPKITALL** 2.7mm Locking Screw Star Head & DLP Plate Kit in Prem Box
- LS35STARDLPKITALL** 3.5mm Locking Screw Star Head & DLP Plate Kit in Prem Box

Stacked Hole Locking Plate Kits In Premium Box

- LS20STARKITALL** 2.0mm Locking Screw Star Head & Plate Kit in Prem Box
- LS24STARKITALL** 2.4mm Locking Screw Star Head & Plate Kit in Prem Box
- LS27STARKITALL** 2.7mm Locking Screw Star Head & Plate Kit in Prem Box
- LS35STARKITALL** 3.5mm Locking Screw Star Head & Plate Kit in Prem Box
- LS35KITALL** 3.5mm Locking Screw Hex Head & Plate Kit in Prem Box

Cortical Self Tapping Kits In Premium Boxes



Kit featured is CORTSTP2735

Our self tapping cortical kits in anodised aluminium premium boxes contain plates, screws and required instrumentation.

- CORTSTP152024** 1.5mm/2.0mm/2.4mm Cortical Self Tapping Kit in Premium Box
- CORTSTP2735** 2.7mm/3.5mm Cortical Self Tapping Kit in Premium Box

1.0mm Plating Kit



Management of fractures in dogs weighing less than a kilo is very challenging. Even 1.5 and 2.0mm screws are too large. Metacarpals in even some medium size patients, require very small implants.

The range includes T-plates, compression plates and 5 different cuttable plates. Due to the small size, dedicated instrumentation is required.

- CORTSTP10** 1.0mm Plating Set in Premium Box

Cortical Kits In Stainless Box



Kit featured is CORTSTKIT2735

Our cortical and cortical self tapping kits in stainless box contain plates, screws and required instrumentation.

- CORTKIT1.5/2** 1.5mm/2.0mm Cortical Kit In Stainless Box

Cortical Self Tapping Kits In Stainless Box

- CORTSTKIT1.5** 1.5mm Cortical Self Tapping Kit In Stainless Box
- CORTSTKIT1.5/2** 1.5/2.0mm Cortical Self Tapping Kit In Stainless Box
- CORTSTKIT2.0** 2.0mm Cortical Self Tapping Kit In Stainless Box
- CORTSTKIT24** 2.4mm Cortical Self Tapping Kit In Stainless Box
- CORTSTKIT2735** 2.7/3.5mm Cortical Self Tapping Kit In Stainless Box

Locking Screw Sets



Available with either Hex (3.5mm only) or Star Drive Head.

- LS15STARKIT** 1.5 Star Drive Locking Screw Set
- LS20STARKIT** 2.0 Star Drive Locking Screw Set
- LS24STARKIT** 2.4 Star Drive Locking Screw Set
- LS27STARKIT** 2.7 Star Drive Locking Screw Set
- LS35STARKIT** 3.5 Star Drive Locking Screw Set
- LS35KIT** 3.5 Hex Drive Locking Screw Set

Full kit lists are available upon request.

Vi Plate Selection Chart

This chart is for guidance only and precise implant selection depends on a number of factors which are to be considered when assessing the fracture healing score and the mechanical behaviour of implants; this should be taken into account when making a definitive selection.

Scaled plate profiles are available in the catalogue or download the profiles from our website www.veterinary-instrumentation.co.uk

Vi plate profiles are also available via digital planning applications.

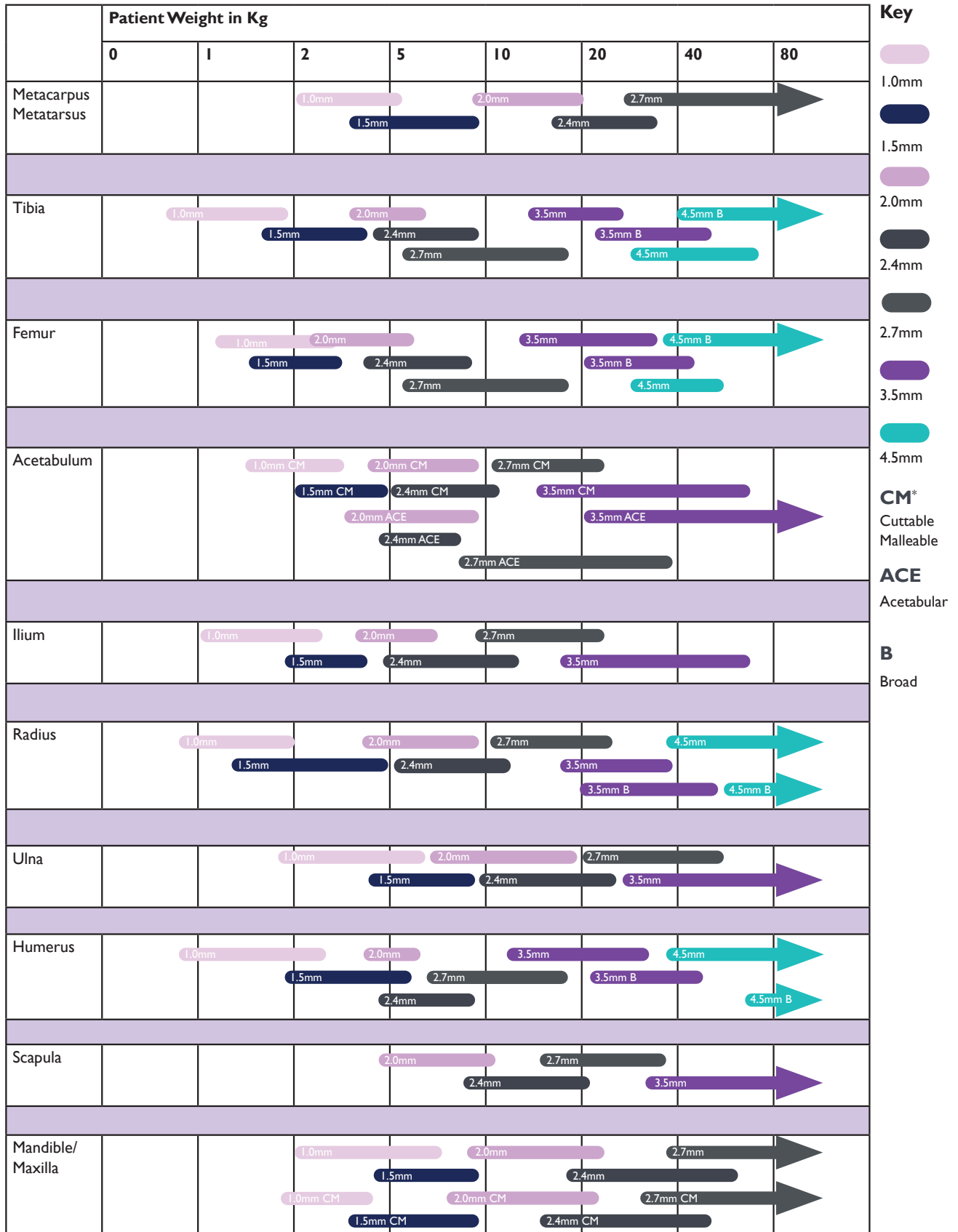

* Please note, Cuttable Malleable and Cuttable Malleable Locking Plates are not suitable for weight bearing fractures unless used in conjunction with other plates.

1.0mm Plates

1.0mm implants currently available consist of a range of straight plates, cuttable plates and an extensive range of T-Plates for radial fractures.

1.0mm Compression Plates



CI00210	1mm Dynamic Compression Plate 10mm 2 Hole
CI00418	1mm Dynamic Compression Plate 18mm 4 Hole
CI00522	1mm Dynamic Compression Plate 22mm 5 Hole
CI00626	1mm Dynamic Compression Plate 26mm 6 Hole
CI00730	1mm Dynamic Compression Plate 30mm 7 Hole
CI00834	1mm Dynamic Compression Plate 34mm 8 Hole
CI00938	1mm Dynamic Compression Plate 38mm 9 Hole
CI01042	1mm Dynamic Compression Plate 42mm 10 Hole

1.0mm Cuttable Plates



The Vi range of cuttable 1.0mm plates gives flexibility of management options for a number of different fracture scenarios. All of our 1.0mm Cuttable Plates have round holes.

Use the dedicated compound action implant cutters (001230) to cut plates.

CP10390	Cutttable Plate 1.0mm 30 Holes 90mm Long
CP10491	Cutttable Plate 1.0mm 23 Holes 91mm Long
CM10390	Cutttable Malleable Plate 1.0mm 30 Holes 90mm Long

1.0mm Cuttable Plates With Spaces



1.0mm cuttable plate with spaces to give the surgeon additional options. Versions are available with either 3mm or 4mm hole spacing.

CP1039027	Cutttable Plate 1.0mm 27 Holes 90 mm 3mm Spaces
CP1049120	Cutttable Plate 1.0mm 20 Holes 91mm 4mm Spaces

1.0mm T-Plates



The 1.0mm T-Plates have been designed by Vi to provide options for the repair of distal radial fractures in very small dogs and in cats. These fractures can be difficult to manage, partly because of the small sizes of the bones involved and partly because the area has relatively poor vascularity resulting in what is often a prolonged healing time.

T101016	1mm T Plate 16mm 5 Hole
T101018	1mm T Plate 18mm 5 Hole
T101020	1mm T Plate 20mm 6 Hole
T101021	1mm T Plate 21mm 6 Hole
T101022	1mm T Plate 22mm 6 Hole
T101024	1mm T Plate 24mm 7 Hole
T101026	1mm T Plate 26mm 7 Hole
T101027	1mm T Plate 27mm 7 Hole

1.0mm Cortical Self Tapping Screws

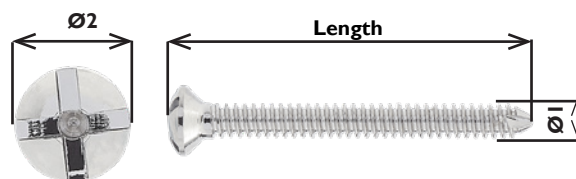

Use 0.7mm pilot drill and 1.0mm cruciate screwdriver. The threads on the screws are very fine. Caution must be exercised at the final tightening.

CSST1004	1mm Self Tapping Screw 4mm
CSST1005	1mm Self Tapping Screw 5mm
CSST1006	1mm Self Tapping Screw 6mm
CSST1007	1mm Self Tapping Screw 7mm
CSST1008	1mm Self Tapping Screw 8mm
CSST1009	1mm Self Tapping Screw 9mm
CSST1010	1mm Self Tapping Screw 10mm
CSST1011	1mm Self Tapping Screw 11mm
CSST1012	1mm Self Tapping Screw 12mm
CSST1013	1mm Self Tapping Screw 13mm
CSST1014	1mm Self Tapping Screw 14mm
CSST1015	1mm Self Tapping Screw 15mm

Screwdriver Insert

SDINI.0-A Dental Fit Screw Driver Insert For 1mm Screws

Drill Guide 0.7/1.0mm



Due to the size limitations, this device serves only as a drill guide and cannot be used as an insert sleeve or tap guide.

CDTIS10 Drill Guide 0.7mm/1.0mm

1.0mm Plate Holding Forceps



Use to hold a plate in position on the bone.

CIPHF 1.0mm Plate Holding Forceps

Mini Quick Release Drill Bits - Dental Fit

These smaller drill bits are too delicate for use with a power drill, and are designed for use with the D17-080 dental fit handle. This improves control and helps prevent breakages.

10MDB07-A	0.7mm Drill Bit For D17-080 Quick Release Handle Dental Fit
10MDB10-A	1.0mm Drill Bit For D17-080 Quick Release Handle Dental Fit

For scaled plate profiles, please view the Plate Profile chapter.

Vi Dynamic Locking Plates

To view our Surgery Guide on 'Fixation of Long Bone (Diaphyseal) Fractures Using Locking Plates and Screws' please scan the QR code below.



- Combining compression and locking technology in one plate.
- 270° of locking thread engagement in plate for superior security.
- Compression section of hole allows up to 35° of screw angulation.
- Suitable for MIPO application - spade end for easier insertion, single full locking hole at opposite end allows drill guide to be used to aid plate manipulation.



1.5mm Vi Dynamic Locking Plates

DLP1504024	1.5mm Dynamic Locking Plate 4 Hole 24mm Long
DLP1505030	1.5mm Dynamic Locking Plate 5 Hole 30mm Long
DLP1506036	1.5mm Dynamic Locking Plate 6 Hole 36mm Long
DLP1507042	1.5mm Dynamic Locking Plate 7 Hole 42mm Long
DLP1508048	1.5mm Dynamic Locking Plate 8 Hole 48mm Long
DLP1509054	1.5mm Dynamic Locking Plate 9 Hole 54mm Long
DLP1510060	1.5mm Dynamic Locking Plate 10 Hole 60mm Long
DLP1511066	1.5mm Dynamic Locking Plate 11 Hole 66mm Long
DLP1512072	1.5mm Dynamic Locking Plate 12 Hole 72mm Long

2.0mm Vi Dynamic Locking Plates

1.5mm thick

DLP2004031	Dynamic Locking Plate 2.0mm 4 Hole 31mm Long
DLP2005038	Dynamic Locking Plate 2.0mm 5 Hole 38mm Long
DLP2006045	Dynamic Locking Plate 2.0mm 6 Hole 45mm Long
DLP2007052	Dynamic Locking Plate 2.0mm 7 Hole 52mm Long
DLP2008059	Dynamic Locking Plate 2.0mm 8 Hole 59mm Long
DLP2009066	Dynamic Locking Plate 2.0mm 9 Hole 66mm Long
DLP2010073	Dynamic Locking Plate 2.0mm 10 Hole 73mm Long
DLP2011080	Dynamic Locking Plate 2.0mm 11 Hole 80mm Long
DLP2012087	Dynamic Locking Plate 2.0mm 12 Hole 87mm Long
DLP2013094	Dynamic Locking Plate 2.0mm 13 Hole 94mm Long
DLP2014101	Dynamic Locking Plate 2.0mm 14 Hole 101mm Long

2.4mm Vi Dynamic Locking Plates

Available in two thicknesses - 1.7mm (thin) and 2.0mm (thick).

DLP2404038N	Dynamic Locking Plate 2.4mm Thin 4 Holes 38mm Long
DLP2405047N	Dynamic Locking Plate 2.4mm Thin 5 Holes 47mm Long
DLP2405047K	Dynamic Locking Plate 2.4mm Thick 5 Holes 47mm Long
DLP2406056N	Dynamic Locking Plate 2.4mm Thin 6 Holes 56mm Long
DLP2406056K	Dynamic Locking Plate 2.4mm Thick 6 Holes 56mm Long
DLP2407065N	Dynamic Locking Plate 2.4mm Thin 7 Holes 65mm Long
DLP2407065K	Dynamic Locking Plate 2.4mm Thick 7 Holes 65mm Long
DLP2408074N	Dynamic Locking Plate 2.4mm Thin 8 Holes 74mm Long
DLP2408074K	Dynamic Locking Plate 2.4mm Thick 8 Holes 74mm Long
DLP2409083N	Dynamic Locking Plate 2.4mm Thin 9 Holes 83mm Long
DLP2409083K	Dynamic Locking Plate 2.4mm Thick 9 Holes 83mm Long
DLP2410092N	Dynamic Locking Plate 2.4mm Thin 10 Holes 92mm Long
DLP2410092K	Dynamic Locking Plate 2.4mm Thick 10 Holes 92mm Long

DLP2411101N	Dynamic Locking Plate 2.4mm Thin 11 Holes 101mm Long
DLP2411101K	Dynamic Locking Plate 2.4mm Thick 11 Holes 101mm Long
DLP2412110K	Dynamic Locking Plate 2.4mm Thick 12 Holes 110mm Long
DLP2413119N	Dynamic Locking Plate 2.4mm Thin 13 Holes 119mm Long
DLP2413119K	Dynamic Locking Plate 2.4mm Thick 13 Holes 119mm Long
DLP2414128K	Dynamic Locking Plate 2.4mm Thick 14 Holes 128mm Long
DLP2415137K	Dynamic Locking Plate 2.4mm Thick 15 Holes 137mm Long
DLP2416146K	Dynamic Locking Plate 2.4mm Thick 16 Holes 146mm Long
DLP2417155K	Dynamic Locking Plate 2.4mm Thick 17 Holes 155mm Long
DLP2418164K	Dynamic Locking Plate 2.4mm Thick 18 Holes 164mm Long

2.7mm Vi Dynamic Locking Plates

DLP2704038	Dynamic Locking Plate 2.7mm 4 Holes 38mm Long
DLP2705047	Dynamic Locking Plate 2.7mm 5 Holes 47mm Long
DLP2706056	Dynamic Locking Plate 2.7mm 6 Holes 56mm Long
DLP2707065	Dynamic Locking Plate 2.7mm 7 Holes 65mm Long
DLP2708074	Dynamic Locking Plate 2.7mm 8 Holes 74mm Long
DLP2709083	Dynamic Locking Plate 2.7mm 9 Holes 83mm Long
DLP2710092	Dynamic Locking Plate 2.7mm 10 Holes 92mm Long
DLP2711101	Dynamic Locking Plate 2.7mm 11 Holes 101mm Long
DLP2712110	Dynamic Locking Plate 2.7mm 12 Holes 110mm Long
DLP2713119	Dynamic Locking Plate 2.7mm 13 Holes 119mm Long
DLP2714128	Dynamic Locking Plate 2.7mm 14 Holes 128mm Long
DLP2715137	Dynamic Locking Plate 2.7mm 15 Holes 137mm Long
DLP2716146	Dynamic Locking Plate 2.7mm 16 Holes 146mm Long
DLP2717155	Dynamic Locking Plate 2.7mm 17 Holes 155mm Long
DLP2718164	Dynamic Locking Plate 2.7mm 18 Holes 164mm Long

3.5mm Vi Dynamic Locking Plates

DLP3504055	Dynamic Locking Plate 3.5mm 4 Holes 55mm Long
DLP3505068	Dynamic Locking Plate 3.5mm 5 Holes 68mm Long
DLP3506081	Dynamic Locking Plate 3.5mm 6 Holes 81mm Long
DLP3507094	Dynamic Locking Plate 3.5mm 7 Holes 94mm Long
DLP3508107	Dynamic Locking Plate 3.5mm 8 Holes 107mm Long
DLP3509120	Dynamic Locking Plate 3.5mm 9 Holes 120mm Long
DLP3510133	Dynamic Locking Plate 3.5mm 10 Holes 133mm Long
DLP3511146	Dynamic Locking Plate 3.5mm 11 Holes 146mm Long
DLP3512159	Dynamic Locking Plate 3.5mm 12 Holes 159mm Long
DLP3513172	Dynamic Locking Plate 3.5mm 13 Holes 172mm Long
DLP3514185	Dynamic Locking Plate 3.5mm 14 Holes 185mm Long
DLP3515198	Dynamic Locking Plate 3.5mm 15 Holes 198mm Long
DLP3516211	Dynamic Locking Plate 3.5mm 16 Holes 211mm Long
DLP3517224	Dynamic Locking Plate 3.5mm 17 Holes 224mm Long
DLP3518237	Dynamic Locking Plate 3.5mm 18 Holes 237mm Long

3.5mm Vi Dynamic Locking Plates Broad

DLP35B07095	3.5mm Broad Dynamic Locking Plate 7 Holes 95mm Long
DLP35B08108	3.5mm Broad Dynamic Locking Plate 8 Holes 108mm Long
DLP35B09121	3.5mm Broad Dynamic Locking Plate 9 Holes 121mm Long
DLP35B10134	3.5mm Broad Dynamic Locking Plate 10 Holes 134mm Long
DLP35B11147	3.5mm Broad Dynamic Locking Plate 11 Holes 147mm Long
DLP35B12160	3.5mm Broad Dynamic Locking Plate 12 Holes 160mm Long
DLP35B13173	3.5mm Broad Dynamic Locking Plate 13 Holes 173mm Long
DLP35B14186	3.5mm Broad Dynamic Locking Plate 14 Holes 186mm Long
DLP35B15199	3.5mm Broad Dynamic Locking Plate 15 Holes 199mm Long
DLP35B16212	3.5mm Broad Dynamic Locking Plate 16 Holes 212mm Long
DLP35B18238	3.5mm Broad Dynamic Locking Plate 18 Holes 238mm Long
DLP35B20264	3.5mm Broad Dynamic Locking Plate 20 Holes 264mm Long

For scaled plate profiles, please view the Plate Profile chapter.

Stacked Hole Locking Plates

Stacked Hole Locking Plates are designed with round threaded plate holes which will accept either locking screws (at a fixed 90 degree angle), or cortical screws (some angulation is possible when using cortical screws). If a combination of dynamic compression and locking function is required, please refer to our range of Dynamic Locking Plates.



2.0mm Plates With Stacked Locking Holes

LPSH200425	2.0mm Locking Plate 4 Hole 25mm Long
LPSH200531	2.0mm Locking Plate 5 Hole 32mm Long
LPSH200637	2.0mm Locking Plate 6 Hole 37mm Long
LPSH200743	2.0mm Locking Plate 7 Hole 43mm Long
LPSH200849	2.0mm Locking Plate 8 Hole 49mm Long
LPSH200955	2.0mm Locking Plate 9 Hole 55mm Long
LPSH201061	2.0mm Locking Plate 10 Hole 61mm Long
LPSH201167	2.0mm Locking Plate 11 Hole 67mm Long
LPSH201273	2.0mm Locking Plate 12 Hole 73mm Long
LPSH201379	2.0mm Locking Plate 13 Hole 79mm Long
LPSH201485	2.0mm Locking Plate 14 Hole 85mm Long
LS20PSET	2.0mm Locking Plate Set (Contains One Of Each)

2.4mm Plates With Stacked Locking Holes

LPSH240431	2.4mm Locking Plate 4 Hole 31mm Long
LPSH240538	2.4mm Locking Plate 5 Hole 38mm Long
LPSH240645	2.4mm Locking Plate 6 Hole 45mm Long
LPSH240752	2.4mm Locking Plate 7 Hole 52mm Long
LPSH240859	2.4mm Locking Plate 8 Hole 59mm Long
LPSH240966	2.4mm Locking Plate 9 Hole 66mm Long
LPSH241073	2.4mm Locking Plate 10 Hole 73mm Long
LPSH241180	2.4mm Locking Plate 11 Hole 80mm Long
LPSH241287	2.4mm Locking Plate 12 Hole 87mm Long
LPSH241394	2.4mm Locking Plate 13 Hole 94mm Long
LPSH2414101	2.4mm Locking Plate 14 Hole 101mm Long
LPSH2415108	2.4mm Locking Plate 15 Hole 108mm Long
LPSH2416115	2.4mm Locking Plate 16 Hole 115mm Long
LPSH2417122	2.4mm Locking Plate 17 Hole 122mm Long
LPSH2418129	2.4mm Locking Plate 18 Hole 129mm Long
LS24PSET	2.4mm Locking Plate Set (Contains One Of Each)

2.7mm Plates With Stacked Locking Holes

LPSH2704034	2.7mm Locking Plate 4 Hole 34mm Long
LPSH2705042	2.7mm Locking Plate 5 Hole 42mm Long
LPSH2706050	2.7mm Locking Plate 6 Hole 50mm Long
LPSH2707058	2.7mm Locking Plate 7 Hole 58mm Long
LPSH2708066	2.7mm Locking Plate 8 Hole 66mm Long
LPSH2709074	2.7mm Locking Plate 9 Hole 74mm Long
LPSH2710082	2.7mm Locking Plate 10 Hole 82mm Long
LPSH2711090	2.7mm Locking Plate 11 Hole 90mm Long
LPSH2712098	2.7mm Locking Plate 12 Hole 98mm Long
LPSH2713106	2.7mm Locking Plate 13 Hole 106mm Long
LPSH2714114	2.7mm Locking Plate 14 Hole 114mm Long
LPSH2715122	2.7mm Locking Plate 15 Hole 122mm Long
LPSH2716130	2.7mm Locking Plate 16 Hole 130mm Long
LPSH2717138	2.7mm Locking Plate 17 Hole 138mm Long
LPSH2718146	2.7mm Locking Plate 18 Hole 146mm Long
LS27PSET	2.7mm Locking Plate Set (Contains One Of Each)

3.5mm Plates With Stacked Locking Holes

LPSH3504046	3.5mm Locking Plate 4 Hole 46mm
LPSH3505056	3.5mm Locking Plate 5 Hole 56mm
LPSH3506066	3.5mm Locking Plate 6 Hole 66mm
LPSH3507076	3.5mm Locking Plate 7 Hole 76mm
LPSH3508086	3.5mm Locking Plate 8 Hole 86mm
LPSH3508126	3.5mm Locking Plate 8 Hole 126mm
LPSH3509096	3.5mm Locking Plate 9 Hole 96mm
LPSH3510106	3.5mm Locking Plate 10 Hole 106mm
LPSH3511116	3.5mm Locking Plate 11 Hole 116mm
LPSH3512126	3.5mm Locking Plate 12 Hole 126mm
LPSH3513136	3.5mm Locking Plate 13 Hole 136mm
LPSH3514146	3.5mm Locking Plate 14 Hole 146mm
LPSH3515156	3.5mm Locking Plate 15 Hole 156mm
LPSH3516166	3.5mm Locking Plate 16 Hole 166mm
LPSH3517176	3.5mm Locking Plate 17 Hole 176mm
LPSH3518186	3.5mm Locking Plate 18 Hole 186mm
LS35PSET	3.5mm Locking Plate Set (Contains one of each)

For scaled plate profiles, please view the Plate Profile chapter.

Cuttable Malleable Locking Plates

Vi Cuttable Malleable Locking Plates come into their own when pronounced contouring is necessary. They are well suited to situations where bone thickness or bone quality makes application of more conventional implants challenging, such as complicated pelvic fractures, as well as situations where mono-cortical application is desirable. With locking implants intimate bone contact is desirable, however, this is not essential.

The low profile makes these implants useful for craniomaxillofacial surgery and for other areas with limited soft tissue coverage. Manufactured from stainless steel grade 316LVM, they are stiffer than titanium implants of similar dimensions, but are still cuttable with standard implant cutters offering good versatility.

Use should be reserved for low load applications or when load sharing is possible between these and other implants such as with double plating techniques or when load sharing is possible with the bone. Use to span large defects is not recommended.

Contouring can be achieved with the appropriately sized bending levers or roller-style bending pliers. Cutting of these plates can be performed using an appropriately rated Implant Cutter.



Please note, Cuttable Malleable Plates and Cuttable Malleable Locking Plates are not suitable for weight bearing fractures unless used in conjunction with other plates.

CM15LOCK	1.5mm Cuttable Malleable Locking Plate 15 Holes 74mm Long
CM20LOCK	2.0mm Cuttable Malleable Locking Plate 15 Holes 103mm Long
CM24LOCK	2.4mm Cuttable Malleable Locking Plate 15 Holes 125mm Long
CM27LOCK	2.7mm Cuttable Malleable Locking Plate 15 Holes 148mm Long
CM35LOCK	3.5mm Cuttable Malleable Locking Plate 15 Holes 205mm Long

LokRod™ Plates

The LokRod™ Plate was conceived and designed by David Strong MRCVS. LokRod™ Plates may prove useful as an alternative for more traditional fixation modalities, particularly in the management of feline comminuted long bone fractures with only small proximal and distal fragments.

LokRod™ Plates must be used with locking screws. It is mechanically stronger to place the implant as close to the functional axis of the bone as possible, so it is advised to have the underside of the plate holes snugged up to the bone as close as possible. Spanning of the whole bone reduces adverse screw loading and will improve implant life as well as reduce the chances of bone splitting at these sites.

The chamfered tip enables easier MIPO insertion, and the small hole will engage a wire or the tips of reduction forceps to aid positioning. The cylindrical shaft minimises impact on surrounding soft tissues and helps reduce peak loading on the screw-plate and screw-bone interfaces.



LRP24270480	LokRod™ Plate 4 Hole 80mm Long
LRP24270490	LokRod™ Plate 4 Hole 90mm Long
LRP242704100	LokRod™ Plate 4 Hole 100mm Long
LRP242704110	LokRod™ Plate 4 Hole 110mm Long

For scaled plate profiles, please view the Plate Profile chapter.

Dynamic Compression Plates

To view our Surgery Guide on 'Fixation of Long Bone (Diaphyseal) Fractures Using Non-Locking Plates and Screws' please scan the QR code below.



Still a mainstay of veterinary orthopaedics, the DCP allows axial compression across the fracture line where desirable and appropriate. The use of the corresponding screw size, and correct sized Load Neutral Drill Guide for pilot hole placement, is essential to achieve axial compression.



1.5mm Dynamic Compression Plates

C150420	1.5mm Dynamic Compression Plate 20mm 4 Hole
C150525	1.5mm Dynamic Compression Plate 24.5mm 5 Hole
C150629	1.5mm Dynamic Compression Plate 29mm 6 Hole
C150734	1.5mm Dynamic Compression Plate 33.5mm 7 Hole
C150838	1.5mm Dynamic Compression Plate 38mm 8 Hole
C150943	1.5mm Dynamic Compression Plate 42.5mm 9 Hole
C151047	1.5mm Dynamic Compression Plate 47mm 10 Hole
C151152	1.5mm Dynamic Compression Plate 51.5mm 11 Hole
C151256	1.5mm Dynamic Compression Plate 56mm 12 Hole
C151465	1.5mm Dynamic Compression Plate 65mm 14 Hole
C151674	1.5mm Dynamic Compression Plate 74mm 16 Hole

2.0mm Dynamic Compression Plates

CP20422	2mm Dynamic Compression Plate 22mm 4 Hole
CP20527	2mm Dynamic Compression Plate 27mm 5 Hole
CP20632	2mm Dynamic Compression Plate 32mm 6 Hole
CP20737	2mm Dynamic Compression Plate 37mm 7 Hole
CP20842	2mm Dynamic Compression Plate 42mm 8 Hole
CP201052	2mm Dynamic Compression Plate 52mm 10 Hole
CP201262	2mm Dynamic Compression Plate 62mm 12 Hole
CP201472	2mm Dynamic Compression Plate 72mm 14 Hole
CP201682	2mm Dynamic Compression Plate 82mm 16 Hole
CP201892	2mm Dynamic Compression Plate 92mm 18 Hole
MP20317	2mm Mini DCP Plate 17mm 3 Hole
MP20423	2mm Mini DCP Plate 23mm 4 Hole
MP20529	2mm Mini DCP Plate 29mm 5 Hole
MP20635	2mm Mini DCP Plate 35mm 6 Hole
MP20741	2mm Mini DCP Plate 41mm 7 Hole

2.4mm Dynamic Compression Plates

C240431	2.4mm Dynamic Compression Plate 31mm 4 Hole
C240538	2.4mm Dynamic Compression Plate 38mm 5 Hole
C240645	2.4mm Dynamic Compression Plate 45mm 6 Hole
C240752	2.4mm Dynamic Compression Plate 52mm 7 Hole
C240859	2.4mm Dynamic Compression Plate 59mm 8 Hole
C240966	2.4mm Dynamic Compression Plate 66mm 9 Hole
C241073	2.4mm Dynamic Compression Plate 73mm 10 Hole
C241180	2.4mm Dynamic Compression Plate 80mm 11 Hole
C241287	2.4mm Dynamic Compression Plate 87mm 12 Hole
C2414101	2.4mm Dynamic Compression Plate 101mm 14 Hole
C2416115	2.4mm Dynamic Compression Plate 115mm 16 Hole

2.7mm Dynamic Compression Plates

C2702020	2.7mm Dynamic Compression Plate 21mm 2 Hole
C2704036	2.7mm Dynamic Compression Plate 37mm 4 Hole
C2705044	2.7mm Dynamic Compression Plate 45mm 5 Hole
C2706052	2.7mm Dynamic Compression Plate 53mm 6 Hole
C2707060	2.7mm Dynamic Compression Plate 61mm 7 Hole
C2708068	2.7mm Dynamic Compression Plate 69mm 8 Hole
C2709076	2.7mm Dynamic Compression Plate 77mm 9 Hole
C2710084	2.7mm Dynamic Compression Plate 85mm 10 Hole
C2712100	2.7mm Dynamic Compression Plate 100mm 12 Hole
C2714116	2.7mm Dynamic Compression Plate 116mm 14 Hole
C2716132	2.7mm Dynamic Compression Plate 133mm 16 Hole
C2718148	2.7mm Dynamic Compression Plate 148mm 18 Hole

3.5mm Dynamic Compression Plates

C3504050	3.5mm Dynamic Compression Plate 50mm 4 Hole
C3505062	3.5mm Dynamic Compression Plate 62mm 5 Hole
C3506074	3.5mm Dynamic Compression Plate 74mm 6 Hole
C3507086	3.5mm Dynamic Compression Plate 86mm 7 Hole
C3508098	3.5mm Dynamic Compression Plate 98mm 8 Hole
C3509111	3.5mm Dynamic Compression Plate 111mm 9 Hole
C3510122	3.5mm Dynamic Compression Plate 122mm 10 Hole
C3512146	3.5mm Dynamic Compression Plate 146mm 12 Hole
C3514170	3.5mm Dynamic Compression Plate 170mm 14 Hole
C3516194	3.5mm Dynamic Compression Plate 194mm 16 Hole
C3518218	3.5mm Dynamic Compression Plate 218mm 18 Hole
C3520242	3.5mm Dynamic Compression Plate 242mm 20 Hole

Broad 3.5mm Dynamic Compression Plates

BC3506074	3.5mm Broad Dynamic Compression Plate 74mm 6 Hole
BC3507087	3.5mm Broad Dynamic Compression Plate 87mm 7 Hole
BC3508098	3.5mm Broad Dynamic Compression Plate 98mm 8 Hole
BC3509110	3.5mm Broad Dynamic Compression Plate 110mm 9 Hole
BC3510122	3.5mm Broad Dynamic Compression Plate 122mm 10 Hole
BC3511134	3.5mm Broad Dynamic Compression Plate 134mm 11 Hole
BC3512146	3.5mm Broad Dynamic Compression Plate 146mm 12 Hole
BC3513158	3.5mm Broad Dynamic Compression Plate 158mm 13 Hole
BC3514170	3.5mm Broad Dynamic Compression Plate 170mm 14 Hole
BC3515182	3.5mm Broad Dynamic Compression Plate 182mm 15 Hole
BC3516194	3.5mm Broad Dynamic Compression Plate 194mm 16 Hole
BC3518218	3.5mm Broad Dynamic Compression Plate 218mm 18 Hole

Narrow 4.5mm Dynamic Compression Plates

C45355	4.5mm Dynamic Compression Plate Narrow 55mm 3 Hole
C45471	4.5mm Dynamic Compression Plate Narrow 71mm 4 Hole
C45587	4.5mm Dynamic Compression Plate Narrow 87mm 5 Hole
C456103	4.5mm Dynamic Compression Plate Narrow 103mm 6 Hole
C457119	4.5mm Dynamic Compression Plate Narrow 119mm 7 Hole
C458135	4.5mm Dynamic Compression Plate Narrow 135mm 8 Hole
C459151	4.5mm Dynamic Compression Plate Narrow 151mm 9 Hole
C4510167	4.5mm Dynamic Compression Plate Narrow 167mm 10 Hole
C4511183	4.5mm Dynamic Compression Plate Narrow 183mm 11 Hole
C4512199	4.5mm Dynamic Compression Plate Narrow 199mm 12 Hole
C4513215	4.5mm Dynamic Compression Plate Narrow 215mm 13 Hole
C4514231	4.5mm Dynamic Compression Plate Narrow 231mm 14 Hole
C4515246	4.5mm Dynamic Compression Plate Narrow 246mm 15 Hole
C4518296	4.5mm Dynamic Compression Plate Narrow 296mm 18 Hole

Broad 4.5mm Dynamic Compression Plates

B4507119	4.5mm Broad Dynamic Compression Plate 119mm 7 Hole
B4508135	4.5mm Broad Dynamic Compression Plate 135mm 8 Hole
B4509151	4.5mm Broad Dynamic Compression Plate 151mm 9 Hole
B4510167	4.5mm Broad Dynamic Compression Plate 167mm 10 Hole
B4511183	4.5mm Broad Dynamic Compression Plate 183mm 11 Hole
B4512199	4.5mm Broad Dynamic Compression Plate 199mm 12 Hole
B4513215	4.5mm Broad Dynamic Compression Plate 215mm 13 Hole
B4515247	4.5mm Broad Dynamic Compression Plate 247mm 15 Hole
B4516263	4.5mm Broad Dynamic Compression Plate 263mm 16 Hole
B4517279	4.5mm Broad Dynamic Compression Plate 279mm 17 Hole
B4518295	4.5mm Broad Dynamic Compression Plate 295mm 18 Hole

For scaled plate profiles, please view the Plate Profile chapter.



Email Marketing Service

Our marketing emails are designed to **educate**, to keep you up to date with what's new at Vi and share **exclusive offers and discounts**.

Sign up today by scanning the QR code below.



ASYM[®] Plates

Plate design combining the established principles of round hole and compression plates. These plates are particularly suitable for a fracture or osteotomy scenario where one fragment is significantly smaller, (more distal/proximal) than the other. The round holes provide greater screw stability, and allow for more screws to be placed, in the smaller fragment, whilst compression can still be applied from the longer segment.

2.0mm ASYM[®] Plates

ASYM20030437	2mm ASYM Plate 37mm 4 Compression 3 Round Holes
ASYM20030542	2mm ASYM Plate 42mm 5 Compression 3 Round Holes
ASYM20030647	2mm ASYM Plate 47mm 6 Compression 3 Round Holes
ASYM20030752	2mm ASYM Plate 52mm 7 Compression 3 Round Holes
ASYM20040652	2mm ASYM Plate 52mm 6 Compression 4 Round Holes
ASYM20030857	2mm ASYM Plate 57mm 8 Compression 3 Round Holes

2.4mm ASYM[®] Plates

ASYM240304052	2.4mm ASYM Plates 52mm 4 Compression 3 Round Holes
ASYM240305059	2.4mm ASYM Plates 59mm 5 Compression 3 Round Holes
ASYM240306066	2.4mm ASYM Plates 66mm 6 Compression 3 Round Holes
ASYM240307073	2.4mm ASYM Plates 73mm 7 Compression 3 Round Holes

2.7mm ASYM[®] Plates

ASYM270304060	2.7mm ASYM Plate 60mm 4 Compression 3 Round Holes
ASYM270305068	2.7mm ASYM Plate 68mm 5 Compression 3 Round Holes
ASYM270306076	2.7mm ASYM Plate 76mm 6 Compression 3 Round Holes
ASYM270307084	2.7mm ASYM Plate 84mm 7 Compression 3 Round Holes

3.5mm ASYM[®] Plates

ASYM350304086	3.5mm ASYM Plate 86mm 4 Compression 3 Round Holes
ASYM350305098	3.5mm ASYM Plate 98mm 5 Compression 3 Round Holes
ASYM350306110	3.5mm ASYM Plate 110mm 6 Compression 3 Round Holes
ASYM350307122	3.5mm ASYM Plate 122mm 7 Compression 3 Round Holes
ASYM350308134	3.5mm ASYM Plate 134mm 8 Compression 3 Round Holes

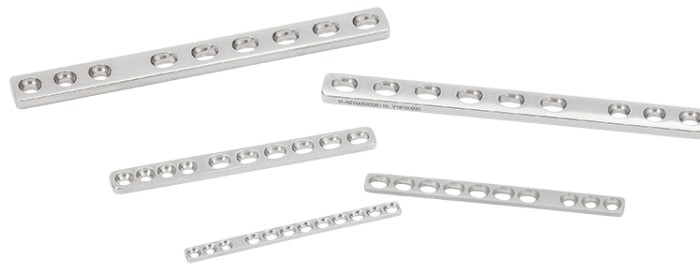

For scaled plate profiles, please view the Plate Profile chapter.

Cutttable Plates

Available in 1.0mm to 3.5mm sizes, the versatility of these plates lies in their close hole spacing, and they can be cut to length intra-op. They are not as stiff or as strong as compression plates of the equivalent size, so they are often used in conjunction with other fixation methods e.g. in combination with IM pinning, double plating including stacked plating, edge-loaded, or where elastic osteogenesis is considered advantageous.

Please see page 87 for the 1.0mm range of Cuttable Plates.

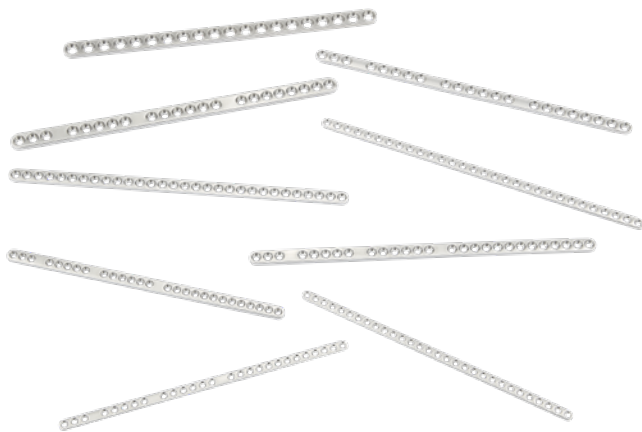

Cutttable Plates Standard Spacing



CP15413030	Cutttable Plate 1.5/2.0 Screws 30 Holes 120 mm Long
CP205150	Cutttable Plate 2.0 Screws 30 Holes 150 mm Long
CP2455150	Cutttable Plate 2.4 Screws 27 Holes 150mm Long
CP276150	Cutttable Plate 2.7 Screws 25 Holes 150 mm Long
CP3575150	Cutttable Plate 3.5 Screws 20 Holes 150 mm Long

Cutttable Plates Standard Spacing Broad

CP15413030B	Cutttable Broad 1.5mm Plate 1.5 Screws 30 Holes 121mm Long
CP205150B	Cutttable Broad 2.0mm Plate 2.0 Screws 30 Holes 150mm Long
CP276150B	Cutttable Broad 2.7mm Plate 2.7 Screws 25 Holes 150mm Long

Cutttable Plates With Spaces



CP15413027	Cutttable Plate With Spaces 1.5/2.0mm Screws 27 Holes 120mm Long
CP20515027	Cutttable Plate With Spaces 2.0mm Screws 27 Holes 150mm Long
CP245515024	Cutttable Plate With Spaces 2.4mm Screws 24 Holes 150mm Long
CP27615022	Cutttable Plate With Spaces 2.7mm Screws 22 Holes 150mm Long
CP357515018	Cutttable Plate With Spaces 3.5mm Screws 18 Holes 150mm Long

Cutttable Plates With Spaces Broad

CP15413027B	Cutttable Plate Broad With Spaces 1.5mm Screws 27 Holes 121mm Long
CP20515027B	Cutttable Plate Broad With Spaces 2.0mm Screws 27 Holes 150mm Long
CP27615022B	Cutttable Plate Broad With Spaces 2.7mm Screws 22 Holes 150mm Long

Veterinary Cuttable Plates



VCP202427	2.0mm/2.4mm/2.7mm Cuttable Plate 300mm 50 Holes
VCP202427B	2.0mm/2.4mm/2.7mm Cuttable Broad Plate 300mm 50 Holes

Double Compression Cuttable Plates



DCCP206150	Double Comp Cuttable Plate 2.0mm 25 Holes 150mm Long
DCCP247150	Double Comp Cuttable Plate 2.4mm 21 Holes 150mm Long
DCCP278150	Double Comp Cuttable Plate 2.7mm 19 Holes 150 mm Long

Cutttable Malleable Plates



CM15413030	Cutttable Malleable Plate 1.5mm Screws 30 Holes 121mm Long
CM205150	Cutttable Malleable Plate 2.0mm Screws 30 Holes 150mm Long
CM2455150	Cutttable Malleable Plate 2.4mm Screws 27 Holes 150mm Long
CM276150	Cutttable Malleable Plate 2.7mm Screws 25 Holes 150mm Long
CM3575150	Cutttable Malleable Plate 3.5mm Screws 20 Holes 150mm Long

Cutttable Malleable Locking Plates



CM15LOCK	1.5mm Cuttable Malleable Locking Plate 15 Holes 74mm Long
CM20LOCK	2.0mm Cuttable Malleable Locking Plate 15 Holes 103mm Long
CM24LOCK	2.4mm Cuttable Malleable Locking Plate 15 Holes 125mm Long
CM27LOCK	2.7mm Cuttable Malleable Locking Plate 15 Holes 148mm Long
CM35LOCK	3.5mm Cuttable Malleable Locking Plate 15 Holes 205mm Long

Please note, Cuttable Malleable Plates and Cuttable Malleable Locking Plates are not suitable for weight bearing fractures unless used in conjunction with other plates.

For scaled plate profiles, please view the Plate Profile chapter.

Round Hole Plates

A traditional style of plate that may still have useful applications where budget is a concern. Also, may be useful where axial compression is not desirable or achievable, the round holes may provide a more stable screw/plate interface and the closer hole spacing can be useful for small fragments. More modern plating solutions may be preferable.



2.0mm Round Hole Plates

PR200213	2mm Round Hole Plate 13mm 2 Hole
PR200423	2mm Round Hole Plate 23mm 4 Hole
PR200528	2mm Round Hole Plate 28mm 5 Hole
PR200630	2mm Round Hole Plate 30mm 6 Hole
PR200633	2mm Round Hole Plate 33mm 6 Hole
PR200738	2mm Round Hole Plate 38mm 7 Hole
PR200840	2mm Round Hole Plate 40mm 8 Hole
PR200843	2mm Round Hole Plate 43mm 8 Hole

2.7mm Round Hole Plates

PR270639	2.7mm Round Hole Plate 39mm 6 Hole
PR270745	2.7mm Round Hole Plate 45mm 7 Hole
PR270851	2.7mm Round Hole Plate 51mm 8 Hole

3.5mm Round Hole Plates

P3504052	3.5mm Round Hole Plate 52mm 4 Hole
P3506070	3.5mm Round Hole Plate 70mm 6 Hole
P3506076	3.5mm Round Hole Plate 76mm 6 Hole
P3507082	3.5mm Round Hole Plate 82mm 7 Hole
P3507088	3.5mm Round Hole Plate 88mm 7 Hole
P3508100	3.5mm Round Hole Plate 100mm 8 Hole
P3509106	3.5mm Round Hole Plate 106mm 9 Hole
P3510118	3.5mm Round Hole Plate 118mm 10 Hole

Biological Healing Plates

A traditional style of plate that may still have useful applications where budget is a concern. The solid, stiff midsection is designed to bridge a non-reconstructable fracture. More modern plating solutions may be preferable.



2.0mm Biological Healing Plates

BHP2007060	2.0mm 7 Hole 60mm Long
BHP2008065	2.0mm 8 Hole 65mm Long
BHP2008070	2.0mm 8 Hole 70mm Long
BHP2008075	2.0mm 8 Hole 75mm Long
BHP2008080	2.0mm 8 Hole 80mm Long

2.7mm Biological Healing Plates

BHP2706063	2.7mm 6 Hole 63mm Long
BHP2707073	2.7mm 7 Hole 73mm Long
BHP2707079	2.7mm 7 Hole 79mm Long
BHP2708075	2.7mm 8 Hole 75mm Long
BHP2708081	2.7mm 8 Hole 81mm Long
BHP2708085	2.7mm 8 Hole 85mm Long

3.5mm Biological Healing Plates

BHP3507120	3.5mm 7 Hole 120mm Long
BHP3507130	3.5mm 7 Hole 130mm Long
BHP3507142	3.5mm 7 Hole 142mm Long
BHP3508130	3.5mm 8 Hole 130mm Long
BHP3508142	3.5mm 8 Hole 142mm Long
BHP3508154	3.5mm 8 Hole 154mm Long
BHPB3508142	Broad 3.5mm 8 Hole 142mm Long
BHPB3508154	Broad 3.5mm 8 Hole 154mm Long

For scaled plate profiles, please view the Plate Profile chapter.

T-Plates

T-Plates are mainly used for distal radial fractures, but may also be useful in management of cranial, pelvic or certain scapula fractures. Locking T plates offer inherently better angular stability, which can be useful when managing small fragments.



Locking T-Plates

1.5mm Locking T-Plate



T1515836LOCK 1.5mm Locking T-Plate 8 Holes 36mm Long

2.0mm Locking T-Plates



T2020532LOCK 2.0mm Locking T-Plate 5 Holes 32mm Long

T2020632LOCK 2.0mm Locking T-Plate 6 Holes 32mm Long

T2020850LOCK 2.0mm Locking T-Plate 8 Holes 50mm Long

2.4mm/2.7mm Locking T-Plates



T240531LOCK 2.4mm Locking T-Plate 5 Holes 37mm Long

T2427537LOCK 2.4mm/2.7mm Locking T-Plate 5 Holes 37mm Long

T2427647LOCK 2.4mm/2.7mm Locking T-Plate 6 Holes 47mm Long

T2427755LOCK 2.4mm/2.7mm Locking T-Plate 7 Holes 55mm Long

T2427748LOCK 2.4mm/2.7mm Locking T-Plate 3 Head 4 Shaft 48mm Long

3.5mm Locking T-Plates



T350660LOCK 3.5mm Locking T-Plate 6 Holes 66mm Long

T350766LOCK 3.5mm Locking T-Plate 3 Head 4 Shaft 60mm

T350880LOCK 3.5mm Locking T-Plate 8 Holes 80mm Long

T3510100LOCK 3.5mm Locking T-Plate 10 Holes 100mm Long

T3512120LOCK 3.5mm Locking T-Plate 12 Holes 120mm Long

Compression T-Plates



1.5mm Compression T-Plates

T151520 1.5mm 2 Holes Head 3 Holes Shaft 20mm Long

T151525 1.5mm 2 Holes Head 4 Holes Shaft 25mm Long

T1515626 1.5mm 3 Holes Head 3 Holes Shaft 26mm Long

T1515731 1.5mm 3 Holes Head 4 Holes Shaft 31mm Long

T1515836 1.5mm 3 Holes Head 5 Holes Shaft 36mm Long

T1515940 1.5mm 3 Holes Head 6 Holes Shaft 40mm Long

2.0mm Compression T-Plates

T202025 2.0mm T-Plate 1.5 or 2.0mm Head 2.0mm Shaft 25mm Long
Shaft Width 5.1mm Shaft Thickness 1.5mm

T202027 2.0mm T-Plate 1.5 or 2.0mm Head 2.0mm Shaft 27mm Long
Shaft Width 5.1mm Shaft Thickness 1.5mm

T202032 2.0mm T-Plate 1.5 or 2.0mm Head 2.0mm Shaft 32mm Long
Shaft Width 5.1mm Shaft Thickness 1.5mm

T2020636 2.0mm T-Plate 1.5 or 2.0mm Head 2.0mm Shaft 36mm Long
Shaft Width 5.1mm Shaft Thickness 1.5mm

T2020742 2.0mm T-Plate 1.5 or 2.0mm Head 2.0mm Shaft 42mm Long
Shaft Width 5.1mm Shaft Thickness 1.5mm

T202042 2.0mm T-Plate 1.5 or 2.0mm Head 2.0mm Shaft 42mm Long 8
Hole Shaft Width 5.1mm Shaft Thickness 1.5mm

T202050 2.0mm T-Plate 1.5 or 2.0mm Head 2.0mm Shaft 50mm Long 8
Hole Shaft Width 5.1mm Shaft Thickness 1.5mm

T2020750 2.0mm T-Plate 1.5 or 2.0mm Head 2.0mm Shaft 50mm Long 7
Hole Shaft Width 5.1mm Shaft Thickness 1.5mm

2.4mm Compression T-Plates

T240531 2.4mm T-Plate 5 Holes 31mm Long

T240638 2.4mm T-Plate 6 Holes 38mm Long

T240744 2.4mm T-Plate 7 Holes 44mm Long

T240853 2.4mm T-Plate 8 Holes 53mm Long

T240858 2.4mm T-Plate 8 Holes 58mm Long

T240958 2.4mm T-Plate 9 Holes 58mm Long

T241072 2.4mm T-Plate 10 Holes 72mm Long

T241172 2.4mm T-Plate 11 Holes 72mm Long

2.7mm Compression T-Plates

T270535 2.7mm T-Plate 5 Holes 35mm Long

T270643 2.7mm T-Plate 6 Holes 43mm Long

T270749 2.7mm T-Plate 7 Holes 49mm Long

T270857 2.7mm T-Plate 8 Holes 57mm Long

T270967 2.7mm T-Plate 9 Holes 67mm Long

T270973 2.7mm T-Plate 9 Holes 73mm Long

T271073 2.7mm T-Plate 10 Holes 73mm Long

T271191 2.7mm T-Plate 11 Holes 91mm Long

T271291 2.7mm T-Plate 12 Holes 91mm Long

T271297 2.7mm T-Plate 12 Holes 97mm Long

T271397 2.7mm T-Plate 13 Holes 97mm Long

For scaled plate profiles, please view the Plate Profile chapter.

Combi T-Plates



The Vi Combi T-Plates have been created as an extension of our current T-Plate range. The general shape of the plate is very similar, and this plate comes with the added benefit of locking technology. There are stacked locking holes in the distal end of the plate and dynamic locking holes in the shaft.

Key Features and Benefits:

- Locking construct increases stability
- Stacked locking hole allows placement of either a locking or non-locking screw
- Dynamic Locking holes in proximal section
- K-wire hole
- Available in a range of lengths
- Manufactured from Stainless Steel

1.5mm Combi T-Plates

T151532COMBI	1.5mm Combi T-Plate 32.5mm Long 6 Holes
T1515735COMBI	1.5mm Combi T-Plate 35.5mm Long 7 Holes
T1515947COMBI	1.5mm Combi T-Plate 47mm Long 9 Holes
T15151159COMBI	1.5mm Combi T-Plate 59mm Long 11 Holes

2mm Combi T-Plates

T202033COMBI	2mm Combi T-Plate 33mm Long 5 Holes
T202040COMBI	2mm Combi T-Plate 40mm Long 6 Holes
T2020743COMBI	2mm Combi T-Plate 43.5mm Long 7 Holes
T2020850COMBI	2mm Combi T-Plate 50.5mm Long 8 Holes
T20201065COMBI	2mm Combi T-Plate 65mm Long 10 Holes
T20201279COMBI	2mm Combi T-Plate 79mm Long 12 Holes



2.4mm Combi T-Plates

T242407059COMBI	2.4mm Combi T-Plate 59mm Long 7 Holes
T242408068COMBI	2.4mm Combi T-Plate 68mm Long 8 Holes
T242409077COMBI	2.4mm Combi T-Plate 77mm Long 9 Holes

2.7mm Combi T-Plates

T272708076COMBI	2.7mm Combi T-Plate 76mm Long 8 Holes
T272709086COMBI	2.7mm Combi T-Plate 86mm Long 9 Holes
T272710096COMBI	2.7mm Combi T-Plate 96mm Long 10 Holes

3.5mm Combi T-Plates

T353507082COMBI	3.5mm Combi T-Plate 82mm Long 7 Holes
T353508094COMBI	3.5mm Combi T-Plate 94mm Long 8 Holes
T353510119COMBI	3.5mm Combi T-Plate 119mm Long 10 Holes

For scaled plate profiles, please view the **Plate Profile** chapter.

Scan the QR code below to be the first to hear about our upcoming new plate ranges.



Training & Education

Our **e-learning platform** delivers a variety of technical and clinical educational material, in an engaging and interactive format.

With a CPD certificate awarded upon successful completion of each module, the e-learning platform from Vi will help you to fulfil your annual CPD requirements.

Sign up today by scanning the QR code below.



Hybrid Anatomical T-Plates



2.0mm Hybrid Anatomical T-Plates

- T2027755** Hybrid Anatomical T-Plate 3x 2mm Head Screws
4x 2.7mm Shaft Screws 55mm Long
- T2027758** Hybrid Anatomical T-Plate 3x 2mm Head Screws
4x 2.7mm Shaft Screws 58mm Long

2.7mm Hybrid Anatomical T-Plates

- T273572** Hybrid Anatomical T-Plate 3x 2.7mm Head Screws
4x 3.5mm Shaft Screws 72mm Long
- T273576** Hybrid Anatomical T-Plate 3x 2.7mm Head Screws
4x 3.5mm Shaft Screws 76mm Long

3.5mm Hybrid Anatomical T-Plates

- T3545795** Hybrid Anatomical T-Plate 3x 3.5mm Head Screws
4x 4.5mm Shaft Screws 95mm Long
- T3545799** Hybrid Anatomical T-Plate 3x 3.5mm Head Screws
4x 4.5mm Shaft Screws 99mm Long

Hybrid T-Plates



1.5mm Hybrid T-Plates

- T152034** Hybrid T-Plate - 1.5 Or 2.0mm Head
2.0mm Shaft 34mm Long Cuttable
Shaft Width 4.5mm Shaft Thickness 1.1mm

2.0mm Hybrid T-Plates

- T20242736** Hybrid T-Plate - 2.0, 2.4 Or 2.7mm Head
2.0 2.4 Or 2.7mm Shaft 36mm Long
Shaft Width 7.4mm Shaft Thickness 2mm
- T20242744** Hybrid T-Plate - 2.0, 2.4 Or 2.7mm Head
2.0, 2.4 Or 2.7mm Shaft 44mm Long
Shaft Width 7.4mm Shaft Thickness 2mm
- T20242752** Hybrid T-Plate - 2.0, 2.4 Or 2.7mm Head
2.0 2.4 Or 2.7mm Shaft 52mm Long
Shaft Width 7.4mm Shaft Thickness 2mm
- T20242771** Hybrid T-Plate - 2.0, 2.4 Or 2.7mm Head
2.0 2.4 Or 2.7mm Shaft 71mm Long
Shaft Width 7.4mm Shaft Thickness 2mm

2.7mm Hybrid T-Plates

- T273562** Hybrid T-Plate - 2.7 Or 3.5mm Head
3.5mm Shaft 62mm Long
Shaft Width 9.5mm Shaft Thickness 2mm
- T273585** Hybrid T-Plate - 2.7 Or 3.5mm Head
3.5mm Shaft 85mm Long
Shaft Width 9.5mm Shaft Thickness 2mm

T-Plates Clover Leaf



2.0mm T-Plates Clover Leaf

- TPLO202026** 2.0mm DCP 26mm Overall Length
- TPLO202031** 2.0mm DCP 31mm Overall Length

2.4mm T-Plates Clover Leaf

- TPLO242434** 2.4mm DCP 34mm Overall Length
- TPLO242441** 2.4mm DCP 41mm Overall Length

2.7mm T-Plates Clover Leaf

- TPLO272739** 2.7mm DCP 39mm Overall Length
- TPLO272745** 2.7mm DCP 45mm Overall Length
- TPLO273539** 2.7/3.5 DCP 39mm Overall Length
Allows Use Of 3.5 Cancellous Screw In Head
- TPLO273545** 2.7/3.5 DCP 45mm Overall Length
Allows Use Of 2.7 & 3.5 Screws In Head 2.5mm Thick

3.5mm T-Plates Clover Leaf

- TPLO353555** 3.5mm DCP 55mm Overall Length
- TPLO353557** 3.5mm DCP 57mm Overall Length Heavy Duty
- TPLO353559** 3.5mm DCP 59mm Overall Length
- TPLO353562** 3.5mm DCP 62mm Overall Length
- TPLO353565** 3.5mm DCP 65mm Overall Length
- TPLO353577** 3.5mm DCP 77mm Overall Length 7 Holes
- TPLO353577X** 3.5mm DCP 77mm Overall Length 8 Holes
- TPLO353579** 3.5mm DCP 79mm Overall Length Heavy Duty
- TPLO354579** 3.5/4.5 DCP 79mm Overall Length Heavy Duty
Allows 4.5 Screws In Head
- TPLO35456579** 3.5/4.5 DCP 79mm Overall Length Heavy Duty
Will Accept 6.5 Cancellous Screws In Head 4.5mm Thick

4.5mm T-Plates Clover Leaf

- TPLO45659030** 4.5mm DCP 90mm Overall Length
Will Accept 6.5 Cancellous Screws In Head 3.0mm Thick
- TPLO45659035** 4.5/6.5mm DCP 90mm Overall Length
Will Accept 6.5 Cancellous Screws In Head 3.5mm Thick
- TPLO45659045** 4.5mm DCP 90mm Overall Length
Will Accept 6.5 Cancellous Screws In Head 4.5mm Thick

T-Plates Round Hole

- TC204018** 2mm T-Plate 4 Hole 18mm 2 Holes Distally
- TC205024** 2mm T-Plate 5 Hole 24mm 2 Holes Distally
- OR270532** 2.7mm T-Plate 5 Hole 32mm Oblique R 2 Holes Distally
- TC270639** 2.7mm T-Plate 6 Hole 39mm 2 Holes Distally
- TC350655** 3.5mm T-Plate 6 Hole 55mm 2 Holes Distally
- TC350662** 3.5mm T-Plate 6 Hole 62mm 2 Holes Distally
- TC350777** 3.5mm T-Plate 7 Hole 77mm 2 Holes Distally
- TC350877** 3.5mm T-Plate 8 Hole 77mm 2 Holes Distally

For scaled plate profiles, please view the Plate Profile chapter.

Supracondylar Plates

Supracondylar femoral fractures in mature animals can be very difficult to repair. Small distal fragment size makes placement of sufficient implants a challenge, and there are often multiple small fragments in the supracondylar area. The forces acting on the distal femur are complex requiring a special plate to neutralise them. The original plates were developed by Mark Glyde using finite element analysis and an extra long version for cats has been developed in conjunction with Sorrel Langley-Hobbs.



1.5mm Supracondylar Plates

- I52704** 1.5mm Supracondylar Plate 3 Distal Hole Right
I52703 1.5mm Supracondylar Plate 3 Distal Hole Left

2.0mm Supracondylar Plates

- I52701** Supracondylar Plate 2.0mm - Short Distal End - Right
I52709 Supracondylar Plate 2.0mm - Short Distal End - Left
I52700 Supracondylar Plate 2.0mm 50mm Long - Right - Shaft Width 5.5mm Shaft Thickness 2.0mm
I52710 Supracondylar Plate 2.0mm 50mm Long - Left - Shaft Width 5.5mm Shaft Thickness 2.0mm
I52700XL Supracondylar Plate 2.0mm 120mm Extra Long Cuttable Right Shaft Width 5.5mm Shaft Thickness 2mm
I52710XL Supracondylar Plate 2.0mm 120mm Extra Long Cuttable Left Shaft Width 5.5mm Shaft Thickness 2mm

2.4mm Supracondylar Plates

- I52711R** Supracondylar Plate 2.4mm 62mm Long Right Shaft Width 6.5mm Shaft Thickness 2mm
I52711L Supracondylar Plate 2.4mm 62mm Long Left Shaft Width 6.5mm Shaft Thickness 2mm
I52711R-XL Supracondylar Plate 2.4mm 112mm Extra Long Right Shaft Width 6.5mm Shaft Thickness 2mm
I52711L-XL Supracondylar Plate 2.4mm 112mm Extra Long Left Shaft Width 6.5mm Shaft Thickness 2mm

2.7mm Supracondylar Plates

- I52712** Supracondylar Plate 2.7mm Left 69mm Long
I52714 Supracondylar Plate 2.7mm Right 69mm Long

3.5mm Supracondylar Plates

- I52715N** Supracondylar Plate 3.5mm Narrow Left 135mm Long
I52717N Supracondylar Plate 3.5mm Narrow Right 135mm Long
I52715 Supracondylar Plate 3.5mm Broad Left 135mm Long
I52717 Supracondylar Plate 3.5mm Broad Right 135mm Long
I52716 Supracondylar Plate 3.5mm Broad Left 173mm Long
I52718 Supracondylar Plate 3.5mm Broad Right 173mm Long

Supracondylar Osteotomy Plates (SCOP)

Angular correction of the distal femur by means of a supra-condylar osteotomy (distal femoral osteotomy/DFO) is an accepted technique for correction of patella luxation in medium and large dogs with a limb alignment deformity. The distal femur is a difficult area over which to appropriately contour a plate and place sufficient screws. Using finite element analysis (FEA), Mark Glyde designed a preformed plate specifically for this area. Our SCOP plates feature thinning to the proximal end and smoothing to cranio-distal edge over which there is high motion during stifle flexion/extension.



2.0mm Supracondylar Osteotomy Plates

- I52608** 2.0mm Supracondylar Osteotomy Plate Right
I52609 2.0mm Supracondylar Osteotomy Plate Left
I52612 2.0mm Supracondylar Osteotomy Plate Short Distal End Right
I52613 2.0mm Supracondylar Osteotomy Plate Short Distal End Left

2.4mm Supracondylar Osteotomy Plates

- I52606** 2.4mm Supracondylar Osteotomy Plate Right
I52607 2.4mm Supracondylar Osteotomy Plate Left

2.7mm Supracondylar Osteotomy Plates

- I52600** 2.7mm Supracondylar Osteotomy Plate Right
I52605 2.7mm Supracondylar Osteotomy Plate Left

3.5mm Supracondylar Osteotomy Plates

- I52610** 3.5mm Supracondylar Osteotomy Plate Right
I52615 3.5mm Supracondylar Osteotomy Plate Left
I52620 3.5mm Broad Supracondylar Osteotomy Plate Right
I52625 3.5mm Broad Supracondylar Osteotomy Plate Left

Bending Templates



- BT I52700** Bending Template for 2.0mm Supracondylar Plate
BT I52711 Bending Template for 2.4mm Supracondylar Plate
BT I52714 Bending Template for 2.7mm Supracondylar Plate
BT I52717 Bending Template for 3.5mm Supracondylar Plate

2.0mm Locking Supracondylar Plates



- I52608COMBI** Feline 2mm Combi Supracondylar Plate Right
I52609COMBI Feline 2mm Combi Supracondylar Plate Left

Acetabular Plates

Accurate repair of fractures of the acetabulum is essential if full function is to be restored and long term arthritic changes are to be avoided. Ten sizes are available. These round-holed plates are pre-contoured three dimensionally to ensure a good fit.



2.0mm Acetabular Plates

AP200400XS	2.0mm Acetabular Plate 4 Hole Extra Small
AP200400	2.0mm Acetabular Plate 4 Hole Size 0
AP200401	2.0mm Acetabular Plate 4 Hole Size 1
AP200401L	2.0mm Acetabular Plate 4 Hole Large

2.4mm Acetabular Plate

AP240406	2.4mm Acetabular Plate 4 Hole
-----------------	-------------------------------

2.7mm Acetabular Plates

AP270602	2.7mm Acetabular Plate 6 Hole Size 2
AP270603	2.7mm Acetabular Plate 6 Hole Size 3

3.5mm Acetabular Plates

AP350604	3.5mm Acetabular Plate 6 Hole Size 4
AP350605	3.5mm Acetabular Plate 6 Hole Size 5
AP350607	3.5mm Acetabular Plate 6 Hole Extra Large

Acetabular Plate Set

APSET	Acetabular Plates Set of 10 (One Of Each Of The Plates Listed Above)
--------------	--

Butterfly Plates

A novel plate design with potential use across a range of procedures such as revision/embrocation of TTA repairs, cranial surgery and pelvic surgery.



1.5mm Non-Locking Butterfly Plates

BTFP15414	1.5mm Butterfly Plate 4 Hole 14mm Length
------------------	--

2.0mm Non-Locking Butterfly Plates

BTFP20623	2.0mm Butterfly Plate 6 Hole 23mm Length
------------------	--

For scaled plate profiles, please view the Plate Profile chapter.

Carpal Arthrodesis Plates

Our comprehensive range of plates for carpal arthrodesis take into account the challenges of this procedure and are designed for the dorsal approach.

- Appropriately sized and spaced screw-holes proximally and distally.
- Sufficient strength through the mid-portion.
- Thinning to the distal portion reducing stress riser effects and aiding skin closure.

Partial Carpal Arthrodesis Plates



1.5/2.0mm Partial Carpal Arthrodesis Plates

I52932 Partial Carpal Arthrodesis Plate 1.5/2.0mm

2.0/2.4/2.7mm Partial Carpal Arthrodesis Plates

I52931 Partial Carpal Arthrodesis Plate 2.0/2.4/2.7mm 50mm

2.7/3.5mm Partial Carpal Arthrodesis Plates

I52930 Partial Carpal Arthrodesis Plate 2.7/3.5mm 65mm

Round Hole Pancarpal Arthrodesis Plates

2.7/3.5mm Round Hole Pancarpal Arthrodesis Plates

I52904 2.7mm/3.5mm Carpal Arthrodesis Plate 100mm Rnd
I52904XL 2.7mm/3.5mm Carpal Arthrodesis Plate 116mm XL Rnd

3.5mm Locking & DCP Hybrid Pancarpal Arthrodesis Plates

I52907XLL 3.5mm Locking & DCP Hybrid Pancarpal Arthrodesis Plate 153mm

Locking Pancarpal Arthrodesis Plates



1.5/2.0mm Locking Pancarpal Arthrodesis Plates

PCALK1520 1.5/2.0mm Locking Pancarpal Arthrodesis Plate
PCALK1520L 1.5/2.0mm Locking Pancarpal Arthrodesis Plate - Long

2.0/2.4mm Locking Pancarpal Arthrodesis Plates

PCALK2024 2.0/2.4mm Locking Pancarpal Arthrodesis Plate
PCALK2024L 2.0/2.4mm Locking Pancarpal Arthrodesis Plate - Long

2.0/2.7mm Locking Pancarpal Arthrodesis Plates

PCALK2027 2.0/2.7mm Locking Pancarpal Arthrodesis Plate
PCALK2027L 2.0/2.7mm Locking Pancarpal Arthrodesis Plate - Long

2.7/3.5mm Locking Pancarpal Arthrodesis Plates

PCALK2735 2.7/3.5mm Locking Pancarpal Arthrodesis Plate
PCALK2735L 2.7/3.5mm Locking Pancarpal Arthrodesis Plate - Long

DCP Style Pancarpal Arthrodesis Plates



1.0/1.5mm DCP Pancarpal Arthrodesis Plates

I52970 1.0/1.5mm Pancarpal Arthrodesis Plate

1.5/2.0mm DCP Style Pancarpal Arthrodesis Plates

I52911 1.5mm/2.0mm Compression Arthrodesis Plate
I52911XL 1.5mm/2.0mm Compression Extended Length

2.0/2.0mm DCP Style Pancarpal Arthrodesis Plates

I52912 2.0mm/2.0mm Compression Arthrodesis Plate
I52912XL 2.0mm/2.0mm Compression Extended Length

2.0/2.7mm DCP Style Pancarpal Arthrodesis Plates

I52902 2.0mm/2.7mm Compression Arthrodesis Plate
I52905 2.0mm/2.7mm Compression Arthrodesis Plate
I52905XL 2.0mm/2.7mm Compression Extended Length 90mm

2.7/3.5/4.5mm DCP Style Pancarpal Arthrodesis Plates

I52903 2.7mm/3.5mm Compression Arthrodesis Plate
I52903XL 2.7mm/3.5mm Compression Extended Length
I52907 3.5mm/3.5mm Compression Arthrodesis Plate
PCA2735XL 2.7mm/3.5mm Pancarpal Arthrodesis Plate Extra Long
I52907XL 3.5mm/3.5mm Compression Extended Length
I52909 3.5mm/4.5mm Pancarpal Arthrodesis Plate 185mm

For scaled plate profiles, please view the Plate Profile chapter.

Tarsal Arthrodesis Plates

Our comprehensive range of plates for tarsal arthrodesis take account of the challenges of this procedure. Plates are available for both the medial and dorsal approaches. Medial plates are available either with or without the T4 slot, and a titanium medial plate is available in one size. Plate angulation is set to match the normal standing angles of the target patient population.

Our original range of medial pantarsal arthrodesis plates were developed from custom implants supplied to Malcolm McKee, and improvements subsequently have been made to this original design. The Dorsal Pantarsal Arthrodesis Plate was developed in collaboration with Noel Fitzpatrick and allows the surgeon to benefit from the advantages of dorsal placement, whilst minimising the risks of failure.

Dorsal Pantarsal Arthrodesis Plates



Feline Dorsal Pantarsal Arthrodesis Plate

I52941 Feline Dorsal Pantarsal Arthrodesis Plate 2.0mm/2.0mm
Calcaneal Holes Accept 2.0mm Or 2.4mm Screws

Canine Dorsal Pantarsal Arthrodesis Plate

I52946 Canine Dorsal Pantarsal Arthrodesis Plate 2.4mm/2.7mm/3.5mm

Partial Tarsal Arthrodesis Plates



1.5/2.0mm Partial Tarsal Arthrodesis Plates

I52924 Partial Tarsal Arthrodesis Plate 1.5mm/2.0mm
I52923 Partial Tarsal Arthrodesis Plate 2.0mm/2.0mm

2.0/2.7mm Partial Tarsal Arthrodesis Plates

I52920 Partial Tarsal Arthrodesis Plate 2.0mm/2.7mm
I52922 Partial Tarsal Arthrodesis Plate 2.7mm/2.7mm
I52920SC Partial Tarsal Arthrodesis Plate 2.0mm/2.7mm Short Calcaneus

2.7/3.5mm Partial Tarsal Arthrodesis Plates

I52921 Partial Tarsal Arthrodesis Plate 2.7mm/3.5mm
I52925 Partial Tarsal Arthrodesis Plate 2.7mm/3.5mm

Medial Pantarsal Arthrodesis Plates



Please note that the left and right description for the pantarsal plates applies when the plate is applied medially.

2.0/2.7mm Medial Pantarsal Arthrodesis Plates

I52918 2.0mm/2.7mm Pantarsal Plate Right Cat 120°
I52917 2.0mm/2.7mm Pantarsal Plate Left Cat 120°
I52916 2.0mm/2.7mm Pantarsal Plate Right Dog 140°
I52915 2.0mm/2.7mm Pantarsal Plate Left Dog 140°

2.7/3.5mm Medial Pantarsal Arthrodesis Plates

I52914 2.7mm/3.5mm Pantarsal Plate Right Short
I52913 2.7mm/3.5mm Pantarsal Plate Left Short

Feline Pantarsal Plate With T4 Slot



1.5/2.0mm Feline Pantarsal Plate With T4 Slot

I52967-T4 1.5mm/2.0mm Feline Pantarsal Plate with T4 Slot - 120° Right
I52966-T4 1.5mm/2.0mm Feline Pantarsal Plate with T4 Slot - 120° Left

2.0/2.7mm Feline Pantarsal Plate With T4 Slot

I52918-T4 2.0mm/2.7mm Feline Pantarsal Plate with T4 Slot - 120° Right
I52917-T4 2.0mm/2.7mm Feline Pantarsal Plate with T4 Slot - 120° Left

For scaled plate profiles, please view the Plate Profile chapter.

Canine Pantarsal Arthrodesis Plates With T4 Slot



1.5/2.0mm Canine Pantarsal Arthrodesis Plates With T4 Slot

I52969-T4 1.5mm/2.0mm Canine Pantarsal Plate With T4 Slot - 135° Right
I52968-T4 1.5mm/2.0mm Canine Pantarsal Plate With T4 Slot - 135° Left

2.0/2.7mm Canine Pantarsal Arthrodesis Plates With T4 Slot

I52916-T4 2.0mm/2.7mm Canine (Small) Pantarsal Plate With T4 Slot - 140° Right
I52915-T4 2.0mm/2.7mm Canine (Small) Pantarsal Plate With T4 Slot - 140° Left
I52964-T4 2.0mm/2.7mm Canine Pantarsal Plate With T4 slot – 140° Left
I52965-T4 2.0mm/2.7mm Canine Pantarsal Plate With T4 slot – 140° Right

2.0/2.7/3.5mm Canine Pantarsal Arthrodesis Plates With T4 Slot

I52962-T4 2.0mm/2.7mm/3.5mm Medial Pantarsal Arthrodesis Plate Left With T4
I52963-T4 2.0mm/2.7mm/3.5mm Medial Pantarsal Arthrodesis Plate Right With T4

2.7/3.5mm Canine Pantarsal Arthrodesis Plates With T4 Slot

I52914-T4S 2.7mm/3.5mm Canine Pantarsal Plate With T4 Slot - Right Short
I52913-T4S 2.7mm/3.5mm Canine Pantarsal Plate With T4 Slot - Left Short
I52914-T4 2.7mm/3.5mm Canine Pantarsal Plate With T4 Slot - Right Hand
I52913-T4 2.7mm/3.5mm Canine Pantarsal Plate With T4 Slot - Left Hand

2.7/3.5mm Canine Pantarsal Arthrodesis Plates With T4 Slot - Titanium

I52913-T4TI 2.7mm/3.5mm Canine Pantarsal Arthrodesis T4 Slot Left Titanium
I52914-T4TI 2.7mm/3.5mm Canine Pantarsal Arthrodesis T4 Slot Right Titanium

2.7/3.5/4.5mm Canine Pantarsal Arthrodesis Plates With T4 Slot

I52960-T4 2.7mm/3.5mm/4.5mm Canine Pantarsal Plate With T4 Slot - Left Hand
I52961-T4 2.7mm/3.5mm/4.5mm Canine Pantarsal Plate With T4 Slot - Right Hand

Combi Canine Pantarsal Plates

The Vi Combi 2.7/3.5mm Canine Pantarsal Arthrodesis Plate has been created as an extension of our current Pantarsal Arthrodesis Plates range. Plate shape and standing angle have been carried over from the existing range due to the positive outcomes in surgery over the past 20 years. However, this plate comes with the added benefit of locking technology.

Developed in partnership with leading Orthopaedic Veterinary Surgeons, the plate has been carefully modelled against real life CT scans. A successful design has been achieved through the angling of the distal dynamic locking holes. This design feature was focussed on ensuring the best possible screw projection for maximum bone capture of the metatarsals in the majority of patients.

Key Features and Benefits:

- Locking construct increases stability.
- Stacked locking hole allows placement of either a locking or non-locking screw.
- Dynamic Locking holes in proximal section.
- Angled dynamic locking holes in distal section to allow screw projection through maximum number of metatarsals.
- Angled T4 slotted hole with locking hole at the proximal end of the slot.
- Distal section tapered to follow shape of metatarsals and reduce bone stress.
- Three 1.5mm K-wire holes.
- Available in left and right configuration.



I52913-T4COMBI 2.7/3.5mm Combi Canine Pantarsal Plate Left
I52914-T4COMBI 2.7/3.5mm Combi Canine Pantarsal Plate Right

For scaled plate profiles, please view the Plate Profile chapter.

Elbow Arthrodesis Plates

Elbow arthrodesis may present a realistic option where funds are limited or where joint replacement has failed. Available in a single size designed for the Labrador-sized patient, and available in both locking and non-locking variants.



- I52950** Elbow Arthrodesis Plate 2.7/3.5mm 130° Right
- I52951** Elbow Arthrodesis Plate 2.7/3.5mm 130° Left
- I52950LOCK** Elbow Arthrodesis Plate 2.7/3.5mm 130° Right - Locking
- I52951LOCK** Elbow Arthrodesis Plate 2.7/3.5mm 130° Left - Locking

Limb Salvage Plates

A range of plates for certain scenarios where an extended length plate is required for limb salvage.

2.7/3.5mm Canine Forelimb Salvage Plate



I52903XXL 2.7mm/3.5mm Canine Limb Salvage Plate 262mm Long

Super XXL 3.5/4.5mm Forelimb Salvage Plate



I52980 Super XXL Forelimb Salvage Plate

Feline/Small Canine Forelimb Salvage Plate



I52910 Forelimb Salvage Plate 1.5/2.0mm

Hindlimb Salvage Plates



Feline Hindlimb Salvage Plates

- I52917-T4XL** Feline (120°) Hindlimb Salvage Plate 2.0mm/2.7mm Left
- I52918-T4XL** Feline (120°) Hindlimb Salvage Plate 2.0mm/2.7mm Right

Canine Hindlimb Salvage Plates

- I52913-T4XL** Canine (140°) Hindlimb Salvage Plate 2.7mm/3.5mm Left
- I52914-T4XL** Canine (140°) Hindlimb Salvage Plate 2.7mm/3.5mm Right

For scaled plate profiles, please view the Plate Profile chapter.

LeiLOX 1.5/2.0 Micro Locking System

1.5/2.0 Osteosynthesis Locking Set Titanium

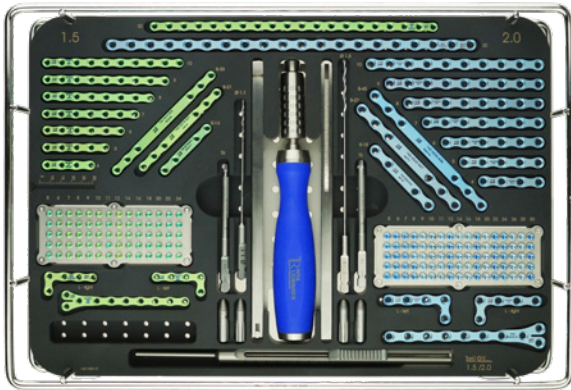

Contains:

- 1x Tray for Implants and Instruments with Lid
- 1x Locking Plate of each style (28 pcs. total)
- 5x of each 1.5 Locking Screw (5-24mm, 70 pcs. total)
- 5x of each 2.0 Locking Screw (5-30mm, 85 pcs. total)
- 2x Screwdriver Shafts
- 1x Screwdriver Handle
- 2x 2 Locking Drill Guides
- 1x Depth Gauge
- 2x Drills (AO, 1.1 and 1.5)
- 1x pair of Bending Irons

LEILOX142-1520-00 LeiLOX Titanium 1.5/2mm Micro Fracture Locking Plate Kit

1.5 Locking Plate Titanium



5mm wide, 1.5mm thick

- LEILOX142-0215-04** LeiLOX Titanium 1.5mm Locking Plate 4 Hole 25.5mm
- LEILOX142-0215-05** LeiLOX Titanium 1.5mm Locking Plate 5 Hole 32.5mm
- LEILOX142-0215-06** LeiLOX Titanium 1.5mm Locking Plate 6 Hole 39.5mm
- LEILOX142-0215-07** LeiLOX Titanium 1.5mm Locking Plate 7 Hole 46.5mm
- LEILOX142-0215-08** LeiLOX Titanium 1.5mm Locking Plate 8 Hole 53.5mm
- LEILOX142-0215-09** LeiLOX Titanium 1.5mm Locking Plate 9 Hole 60.5mm
- LEILOX142-0215-10** LeiLOX Titanium 1.5mm Locking Plate 10 Hole 67.5mm

1.5 Locking Y-Plate Titanium



5mm/11mm wide, 1.5mm thick

LEILOX142-0215-805 LeiLOX Titanium 1.5mm Y-Locking Plate 5 Hole 33mm Long

LeiLOX 1.5mm Locking Screws Titanium



For LeiLOX Locking System. Self-tapping. Requires Star Drive T6 insert

- LEILOX245-415-05** LeiLOX Titanium 1.5mm Locking Screw 5mm
- LEILOX245-415-06** LeiLOX Titanium 1.5mm Locking Screw 6mm
- LEILOX245-415-07** LeiLOX Titanium 1.5mm Locking Screw 7mm
- LEILOX245-415-08** LeiLOX Titanium 1.5mm Locking Screw 8mm
- LEILOX245-415-09** LeiLOX Titanium 1.5mm Locking Screw 9mm
- LEILOX245-415-10** LeiLOX Titanium 1.5mm Locking Screw 10mm
- LEILOX245-415-11** LeiLOX Titanium 1.5mm Locking Screw 11mm
- LEILOX245-415-12** LeiLOX Titanium 1.5mm Locking Screw 12mm
- LEILOX245-415-14** LeiLOX Titanium 1.5mm Locking Screw 14mm
- LEILOX245-415-16** LeiLOX Titanium 1.5mm Locking Screw 16mm
- LEILOX245-415-18** LeiLOX Titanium 1.5mm Locking Screw 18mm
- LEILOX245-415-20** LeiLOX Titanium 1.5mm Locking Screw 20mm
- LEILOX245-415-22** LeiLOX Titanium 1.5mm Locking Screw 22mm
- LEILOX245-415-24** LeiLOX Titanium 1.5mm Locking Screw 24mm
- LEILOX245-415-26** LeiLOX Titanium 1.5mm Locking Screw 26mm

LEILOX128-1520-15 LeiLOX Screwdriver Shaft Star Drive T6 For 1.5mm Screws

2.0 Locking Plate Titanium



6mm wide, 1.5mm thick

- LEILOX142-0220-06** LeiLOX Titanium 2mm Locking Plate 6 Hole 51mm
- LEILOX142-0220-07** LeiLOX Titanium 2mm Locking Plate 7 Hole 60mm
- LEILOX142-0220-08** LeiLOX Titanium 2mm Locking Plate 8 Hole 69mm
- LEILOX142-0220-09** LeiLOX Titanium 2mm Locking Plate 9 Hole 78mm
- LEILOX142-0220-10** LeiLOX Titanium 2mm Locking Plate 10 Hole 87mm

2.0 Locking Y-Plate Titanium



6mm/13.5mm wide, 1.5mm thick

- LEILOX142-0220-805 LeiLOX Titanium 2mm Y-Locking Plate 5 Hole 42mm
- LEILOX142-0220-809 LeiLOX Titanium 2mm Y-Locking Plate 10 Hole Cuttable

LeiLOX 2.0mm Locking Screws Titanium



For LeiLOX Locking System. Self-tapping. Requires Star Drive T8 insert

- LEILOX245-420-05 LeiLOX Titanium 2mm Locking Screw 5mm
- LEILOX245-420-06 LeiLOX Titanium 2mm Locking Screw 6mm
- LEILOX245-420-07 LeiLOX Titanium 2mm Locking Screw 7mm
- LEILOX245-420-08 LeiLOX Titanium 2mm Locking Screw 8mm
- LEILOX245-420-09 LeiLOX Titanium 2mm Locking Screw 9mm
- LEILOX245-420-10 LeiLOX Titanium 2mm Locking Screw 10mm
- LEILOX245-420-11 LeiLOX Titanium 2mm Locking Screw 11mm
- LEILOX245-420-12 LeiLOX Titanium 2mm Locking Screw 12mm
- LEILOX245-420-14 LeiLOX Titanium 2mm Locking Screw 14mm
- LEILOX245-420-16 LeiLOX Titanium 2mm Locking Screw 16mm
- LEILOX245-420-18 LeiLOX Titanium 2mm Locking Screw 18mm
- LEILOX245-420-20 LeiLOX Titanium 2mm Locking Screw 20mm
- LEILOX245-420-22 LeiLOX Titanium 2mm Locking Screw 22mm
- LEILOX245-420-24 LeiLOX Titanium 2mm Locking Screw 24mm
- LEILOX245-420-26 LeiLOX Titanium 2mm Locking Screw 26mm
- LEILOX245-420-28 LeiLOX Titanium 2mm Locking Screw 28mm
- LEILOX245-420-30 LeiLOX Titanium 2mm Locking Screw 30mm

- LEILOX128-1520-20 LeiLOX Screwdriver Shaft Star Drive T8 For 2/2.4mm Screws

LeiLOX Instrumentation

Screwdriver Handle



Silicone AO-Connection. Sterilizable up to 134°C

- TTAR247010300 AO Fit Screwdriver Handle

Screwdriver Shaft Star-Drive



AO-Connection, self-holding

- LEILOX128-1520-15 Screwdriver Shaft Star Drive T6 For 1.5mm Screws
- LEILOX128-1520-20 Screwdriver Shaft Star Drive T8 For 2/2.4mm Screws

Locking Drill Guide



20mm long

- LEILOX164-0015-00 Locking Drill Guide F/1.5mm Screws 1.1mm Drill
- LEILOX164-0020-00 Locking Drill Guide F/2mm Screws 1.5mm Drill

Depth Gauge



Scale up to 40mm, for 1.5/2.0mm screws

- LEILOX164-1520-20 Depth Gauge For 1.5/2mm Screws

Bone Plate Holding Forceps



125mm long, 45mm working end

- LEILOX128-0538-13 Plate Holding Forceps 45mm Angled Tips 125mm Long

Shaft Screws

4.5mm Shaft Screws for HIF



We offer a range of 4.5mm shaft screws specifically designed to be used as trans-condylar stabilising screws. Note that the 4.5mm shaft screws are significantly stronger than a standard 4.5mm cortical screw.

SHSC4532	Shaft Screw	32mm
SHSC4534	Shaft Screw	34mm
SHSC4536	Shaft Screw	36mm
SHSC4538	Shaft Screw	38mm
SHSC4540	Shaft Screw	40mm
SHSC4542	Shaft Screw	42mm
SHSC4544	Shaft Screw	44mm

Please note that a tap is required for the shaft screws. It is also recommended that an insert sleeve is used to centre the pilot hole in the far condyle.

COU4565QR	Quick Release Countersink For 4.5mm/6.5mm Screws AO Fit
COU4565T-A	T Bar Countersink For 4.5mm/6.5mm Screws
DRILLSTOP	Drill Stop Set In Stainless Case
SDH4500	Hex Screwdriver For 4.5mm/5.5mm/6.5mm Screws
H090105S	3.2mm (Pilot) Drill Round Shank
S090105S	3.2mm (Pilot) Drill AO Quick Release
H090108S	4.5mm (Clearance) Drill Round Shank
S090108S	4.5mm (Clearance) Drill AO Quick Release
TS00045	4.5mm Cortical Tap Quick Release - Handle Required
ADJDG45	Adjustable Drill Guide for 4.5mm Drills
SL4532	Insert Sleeve 4.5x3.2mm

Cortical Nuts

N45	4.5mm Cortical Nut Stainless Steel Non Sterile
CN45-A	4.5mm Cortical Nut UHMPWE - Sterile

Condyle Clamp



001080 Condyle Clamp Stainless Steel

Titanium Mesh System



Based on a human product, our Titanium Mesh is cuttable and is mouldable in three-dimensions, making it very adaptable and ideal for cranial fractures and in the management of fractures of other flat bones that are not load bearing.

The mesh has also been used to augment bone cement in joint replacement surgery.

The screws are tapered, making them self-drilling and self-tapping, however, a drill of 1mm diameter or less may be used to start the screws and may help reduce the chances of cracks forming if used close to the fracture lines.

The screws are made of titanium to avoid any problems arising from mixed metallurgy and feature a low profile cruciate head designed for use with the cruciate screwdriver with AO quick release fitting.

A 5mm or 7mm length appears to be the most useful for our species.

TIMESH405006	Titanium Mesh 40mm x 50mm 0.6mm Thick
TIMESH506006	Titanium Mesh 50mm x 60mm 0.6mm Thick
TIMESH607006	Titanium Mesh 60mm x 70mm 0.6mm Thick
TIMESHSCREW2005	Titanium Mesh Screws Tapered 2.0mm x 5.0mm Length Cruciate Head
TIMESHSCREW2007	Titanium Mesh Screws Tapered 2.0mm x 7.0mm Length Cruciate Head
TIMESHSDI	Screwdriver Insert for 2mm Cruciate Titanium Mesh Screws. AO Quick Release



TIMESHCUT	Titanium Mesh Cutters
TIMESHPLI	Titanium Mesh Contouring Pliers

Screw Identification Tree

Use this decision tree tool to help you identify different type of screw. Start on the left and work your way across.

The code prefixes relate to the type of screw e.g. CSST = cortical screw self tapping, LS = locking screw, CAN = cancellous and so on.

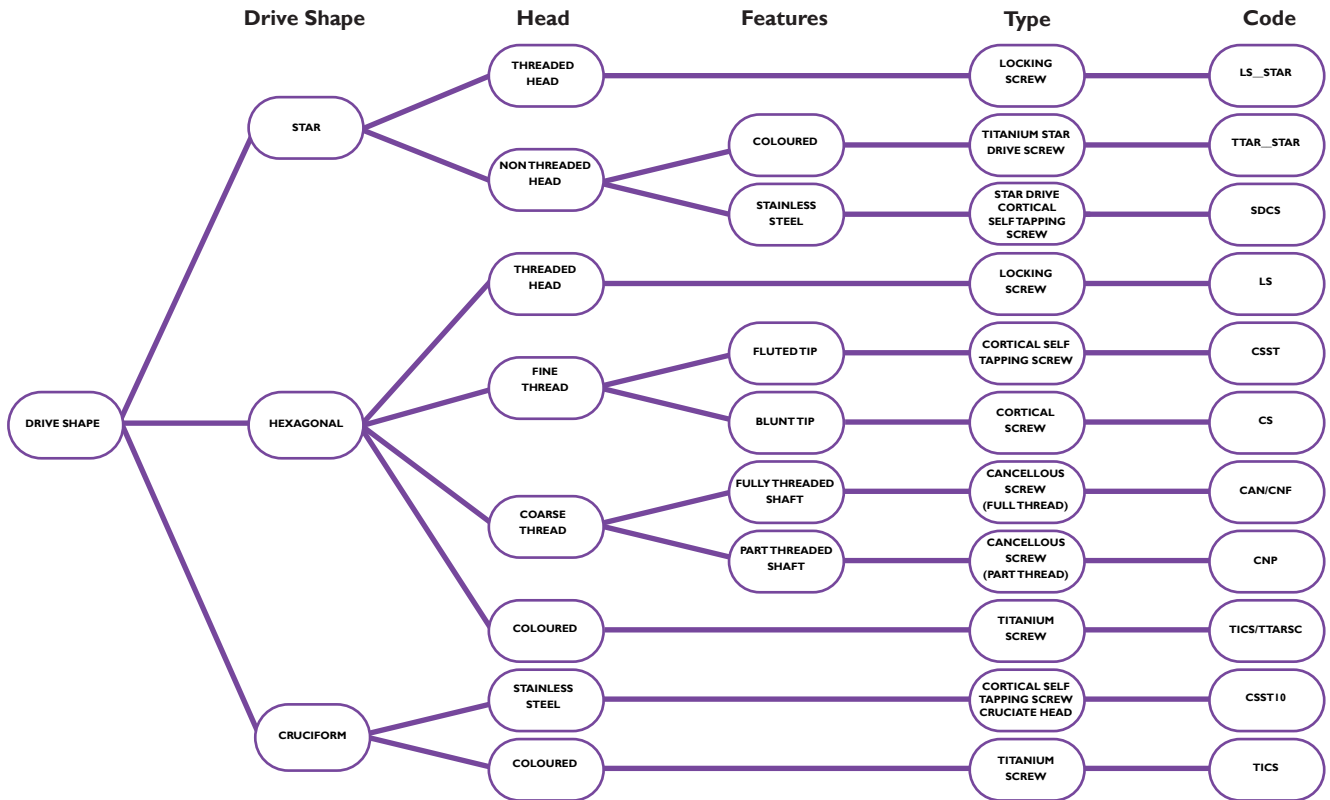

Screw Identification - Type & Size Chart

Once you have used the decision tree to help you identify type, next measure the screw (length and width).

Use this chart to help confirm your identification - where there is a dot in the chart, the corresponding size/type exists.

	1.0mm	1.5mm	2.0mm	2.2mm	2.4mm	2.7mm	3.0mm	3.5mm	4.0mm	4.5mm	5.5mm	6.5mm
CS		●	●			●		●		●	●	
CSST	●	●	●		●	●		●		●		
SDCS		●	●		●	●						
LS								●				
LS-STAR		●	●		●	●		●				
TICS					●	●		●		●		
TTARSC			●		●							
TTAR-STAR		●	●									
CAN				●			●	●				
CNF									●			●
CNP									●			

Vi Screw Types, Drive Shape, Sizes and Ordering Codes For Cortical and Cortical Self Tapping Screws

Once you have used the decision tree and the type/size chart, then refer to this table to confirm your identification and find out the product code (the last two digits of a code, indicated by **, refer to the length of the screw).

Screw Type	Drive Shape	Diameter	Vi Ordering Code
Cortical Non Self Tapping	Hexagonal	1.5mm	CS15**
		2.0mm	CS20**
		2.7mm	CS27**
		3.5mm	CS35**
		4.5mm	CS45**
		5.5mm	CS55**
Cortical Self Tapping	Hexagonal	1.5mm	CSST15**
		2.0mm	CSST20**
		2.4mm	CSST24**
		2.7mm	CSST27**
		3.5mm	CSST35**
		4.5mm	CSST45**
Cortical Self Tapping	Star Drive	1.5mm	SDCSI5**
		2.0mm	SDCS20**
		2.4mm	SDCS24**
		2.7mm	SDCS27**
		3.5mm	SDCS35**
Cortical Self Tapping	Cruciform	1.0mm	CSST10** for 1.0mm

Screwdriver Decision Tree For Cortical, Cortical Self-Tapping and Cancellous Screws Identification Tree

Once you have identified the type and size of screw, use this decision tree to determine the correct screwdriver.

Where there are 2 options in the far right column, this is a fixed shaft screwdriver OR a quick release handle + separate screwdriver shaft (there may be 2 possible codes for the quick release handle).

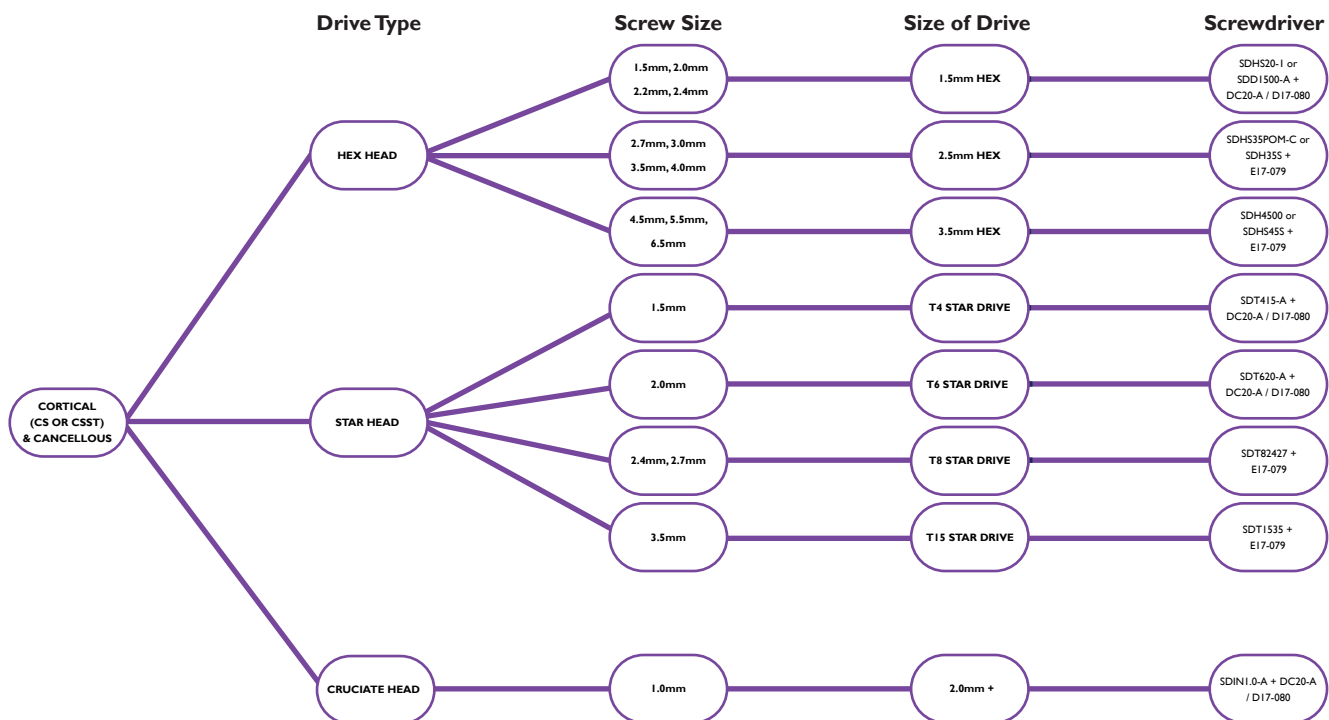

Screwdriver Decision Tree For Locking Screws

Once you have identified the type and size of screw, use this decision tree to determine the correct screwdriver.

Where there are 2 options in the far right column, this is a fixed shaft screwdriver OR a quick release handle + separate screwdriver shaft (there may be 2 possible codes for the quick release handle).

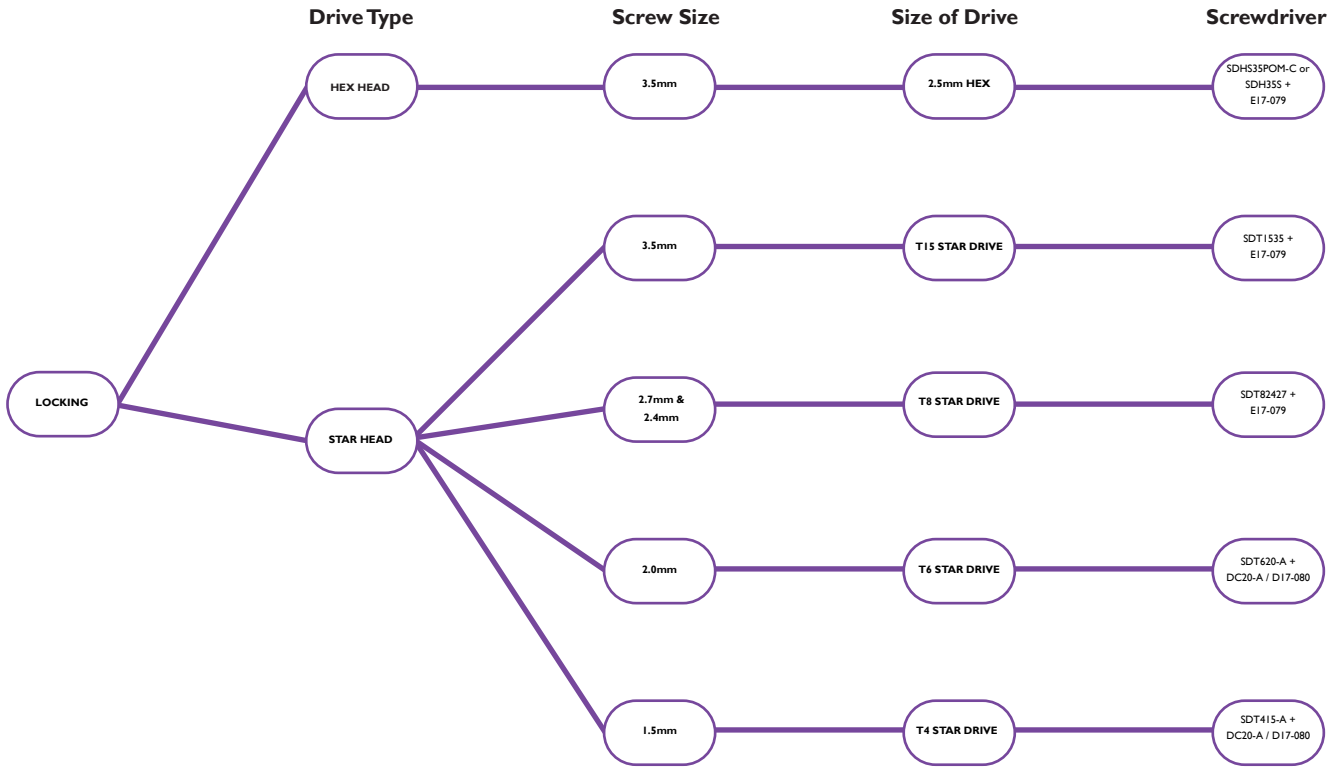

Screwdriver Decision Tree For Titanium Screws

Once you have identified the type and size of screw, use this decision tree to determine the correct screwdriver.

Where there are 2 options in the far right column, this is a fixed shaft screwdriver OR a quick release handle + separate screwdriver shaft (there may be 2 possible codes for the quick release handle).

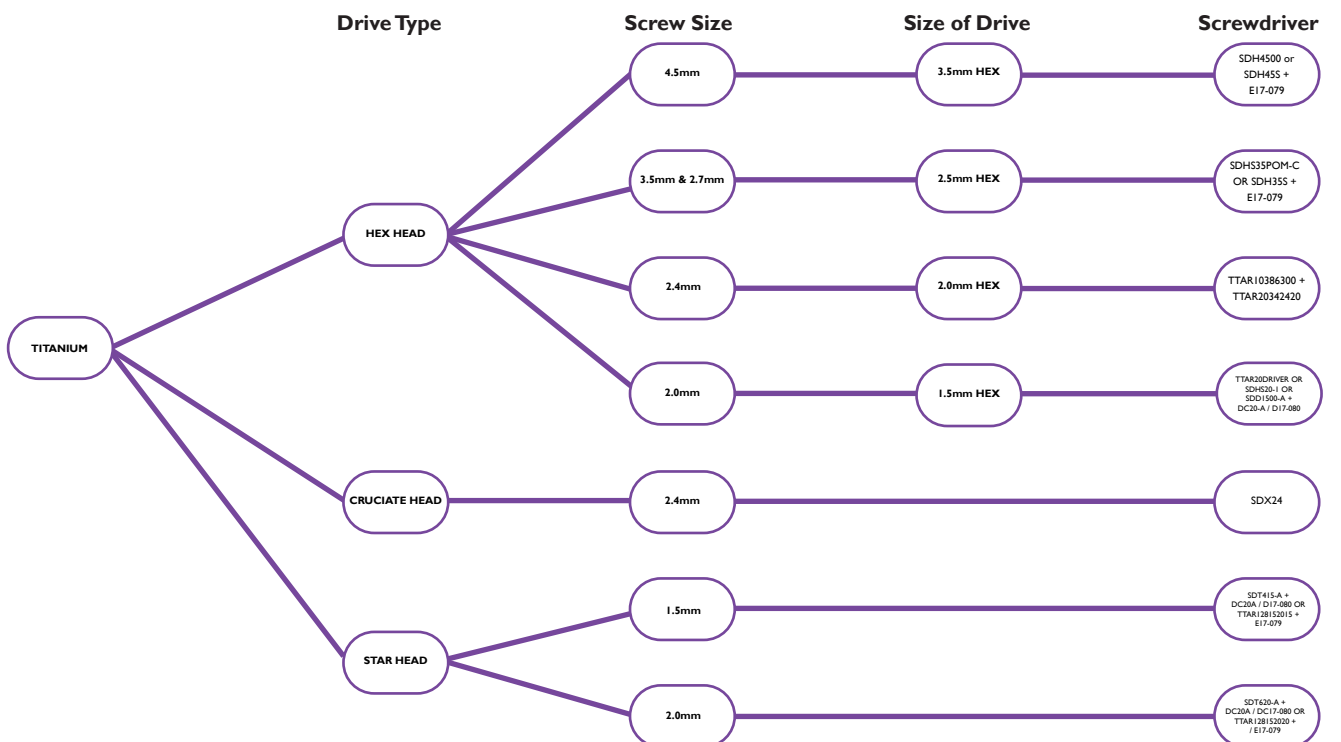

Pilot and Clearance Drill Data For Locking Screws

	Locking Star Drive (1.5mm)	Locking Star Drive (2.0mm)	Locking Star Drive (2.4mm)	Locking Star Drive (2.7mm)	Locking Star Drive (3.5mm)	Locking Hex Head (3.5mm)
Pilot Drill	1.1mm	1.5mm	1.8mm	2.0mm	2.8mm	2.8mm
Round Shank	H090100	H090101	H090208	H090102	H090103	H090103
AO Quick Fit	S090100S	S090101S	S090208	S090102S	S090103S	S090103S
Tap - Modular	TSL515-A (Dental Fit)	TSL520-A (Dental Fit)	TSL524	TSL527	TSL535	TSL535

Pilot and Clearance Drill Data for Cortical Self Tapping Screws

	Cortical Self Tapping (1.0mm)	Cortical Self Tapping (1.5mm)	Cortical Self Tapping (2.0mm)	Cortical Self Tapping (2.4mm)	Cortical Self Tapping (2.7mm)	Cortical Self Tapping (3.5mm)	Cortical Self Tapping (4.5mm)
Pilot Drill	0.7mm	1.1mm	1.5mm	1.8mm	2.0mm	2.5mm	3.2mm
Round Shank	N/A	H090100	H090101	H090208	H090102	H090112	H090105S
AO Quick Fit	10MDB07-A (Dental Fit)	S090100S	S090101S	S090208	S090102SS090102S	S090112S	S090105S
Clearance Drill	1.0mm	1.5mm	2.0mm	2.4mm	2.7mm	3.5mm	4.5mm
Round Shank	N/A	H090101	H090102	H090209	H090104	H090106S	H090108S
AO Quick Fit	10MDB10-A (Dental Fit)	S090101S	S090102S	S090209	S090104S	S090106S	S090108S

Pilot Drill, Clearance Drill and Tap Data for Cortical Non Self Tapping Screws

	Cortical Non Self Tapping (1.5mm)	Cortical Non Self Tapping (2.0mm)	Cortical Non Self Tapping (2.7mm)	Cortical Non Self Tapping (3.5mm)	Cortical Non Self Tapping (4.5mm)	Cortical Non Self Tapping (5.5mm)
Pilot Drill	1.1mm	1.5mm	2.0mm	2.5mm	3.2mm	4.0mm
Round Shank	H090100	H090101	H090102	H090112	H090205S	H090107
AO Quick Fit	S0901022S	S090101S	S090102S	S090112S	S090105S	S090107
Clearance Drill	1.5mm	2.0mm	2.7mm	2.5mm	4.5mm	5.5mm
Round Shank	H090101	H090102	H090104	H090106S	H090108S	H090109
AO Quick Fit	S090101S	S090102S	S090104S	S090106S	S090108S	S090109
Tap - Modular	TD50015	TD0020	TS0027	TS12535	TS00045	TS00055
Tap - "T" Bar	TBT015	TBT020	TBT027	TBT12535	N/A	N/A

Pilot Drill, Clearance Drill and Tap Data for Cancellous Screws

	Small Cancellous (2.2mm)	Small Cancellous (3.0mm)	Small Cancellous (3.5mm)	Cancellous (4.0mm)	Cancellous (6.5mm)
Pilot Drill	1.5mm	2.0mm	2.0mm	2.5mm	3.2mm
Round Shank	H090101	H090102	H090102	H090112	H090105S
AO Quick Fit	S090101S	S090102S	S090102S	S090112S	S090105S
Clearance Drill	2.0mm	3.0mm	3.5mm	4.0mm	6.5mm
Round Shank	H090102	H090205	H090106S	H090107	N/A
AO Quick Fit	S090102S	N/A	S090106S	S090107	N/A
Tap - Modular	N/A	N/A	TS17535	TS17535	TS00065
Tap - "T" Bar	N/A	N/A	TBT17535	TBT17535	

Locking Screws 1.5mm Locking Screws Star Drive

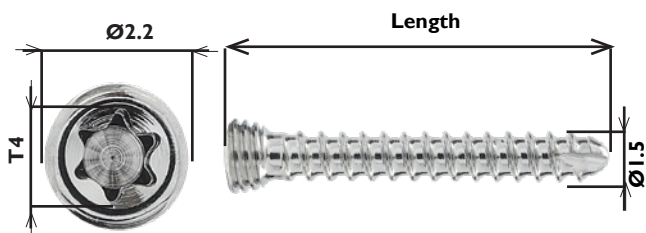

pilot drill - 1.1mm

- LS15STAR06** Locking Star Screw 1.5mm 6mm Long
- LS15STAR07** Locking Star Screw 1.5mm 7mm Long
- LS15STAR08** Locking Star Screw 1.5mm 8mm Long
- LS15STAR09** Locking Star Screw 1.5mm 9mm Long
- LS15STAR10** Locking Star Screw 1.5mm 10mm Long
- LS15STAR11** Locking Star Screw 1.5mm 11mm Long
- LS15STAR12** Locking Star Screw 1.5mm 12mm Long
- LS15STAR14** Locking Star Screw 1.5mm 14mm Long
- LS15STAR16** Locking Star Screw 1.5mm 16mm Long
- LS15STAR18** Locking Star Screw 1.5mm 18mm Long
- LS15STAR20** Locking Star Screw 1.5mm 20mm Long
- LS15STAR22** Locking Star Screw 1.5mm 22mm Long
- LS15STAR24** Locking Star Screw 1.5mm 24mm Long

2.0mm Locking Screws Star Drive

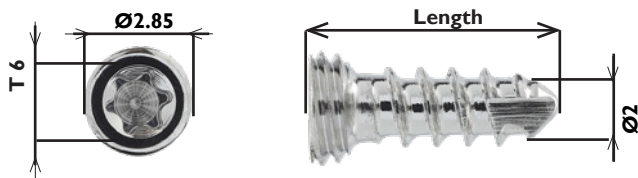

pilot drill - 1.5mm

- LS20STAR06** Locking 2.0mm Screw Star Drive 6mm
- LS20STAR07** Locking 2.0mm Screw Star Drive 7mm
- LS20STAR08** Locking 2.0mm Screw Star Drive 8mm
- LS20STAR10** Locking 2.0mm Screw Star Drive 10mm
- LS20STAR12** Locking 2.0mm Screw Star Drive 12mm
- LS20STAR14** Locking 2.0mm Screw Star Drive 14mm
- LS20STAR16** Locking 2.0mm Screw Star Drive 16mm
- LS20STAR18** Locking 2.0mm Screw Star Drive 18mm
- LS20STAR20** Locking 2.0mm Screw Star Drive 20mm
- LS20STAR22** Locking 2.0mm Screw Star Drive 22mm
- LS20STAR24** Locking 2.0mm Screw Star Drive 24mm
- LS20STAR26** Locking 2.0mm Screw Star Drive 26mm
- LS20STAR28** Locking 2.0mm Screw Star Drive 28mm
- LS20STAR30** Locking 2.0mm Screw Star Drive 30mm

2.4mm Locking Screws Star Drive

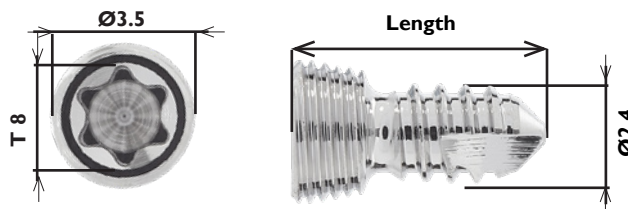

pilot drill - 1.8mm

The 2.4 Locking Screw has the same head dimensions as the 2.7mm Locking Screw (LS2724** series) and may therefore be used in both 2.4mm Locking Plates and 2.7mm Locking Plates.

- LS2424STAR06** Locking 2.4mm Screw Star Drive 6mm
- LS2424STAR08** Locking 2.4mm Screw Star Drive 8mm
- LS2424STAR10** Locking 2.4mm Screw Star Drive 10mm
- LS2424STAR12** Locking 2.4mm Screw Star Drive 12mm
- LS2424STAR14** Locking 2.4mm Screw Star Drive 14mm
- LS2424STAR16** Locking 2.4mm Screw Star Drive 16mm
- LS2424STAR18** Locking 2.4mm Screw Star Drive 18mm
- LS2424STAR20** Locking 2.4mm Screw Star Drive 20mm
- LS2424STAR22** Locking 2.4mm Screw Star Drive 22mm
- LS2424STAR24** Locking 2.4mm Screw Star Drive 24mm
- LS2424STAR26** Locking 2.4mm Screw Star Drive 26mm
- LS2424STAR28** Locking 2.4mm Screw Star Drive 28mm
- LS2424STAR30** Locking 2.4mm Screw Star Drive 30mm
- LS2424STAR32** Locking 2.4mm Screw Star Drive 32mm
- LS2424STAR34** Locking 2.4mm Screw Star Drive 34mm
- LS2424STAR36** Locking 2.4mm Screw Star Drive 36mm
- LS2424STAR38** Locking 2.4mm Screw Star Drive 38mm
- LS2424STAR40** Locking 2.4mm Screw Star Drive 40mm

2.7mm Locking Screws Star Drive

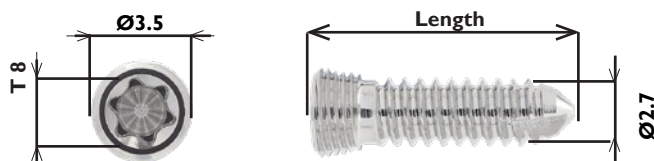

pilot drill - 2.0mm

- LS2724STAR06** Locking 2.7mm Screw (2.4 Head) Star Drive 6mm
- LS2724STAR08** Locking 2.7mm Screw (2.4 Head) Star Drive 8mm
- LS2724STAR10** Locking 2.7mm Screw (2.4 Head) Star Drive 10mm
- LS2724STAR12** Locking 2.7mm Screw (2.4 Head) Star Drive 12mm
- LS2724STAR14** Locking 2.7mm Screw (2.4 Head) Star Drive 14mm
- LS2724STAR16** Locking 2.7mm Screw (2.4 Head) Star Drive 16mm
- LS2724STAR18** Locking 2.7mm Screw (2.4 Head) Star Drive 18mm
- LS2724STAR20** Locking 2.7mm Screw (2.4 Head) Star Drive 20mm
- LS2724STAR22** Locking 2.7mm Screw (2.4 Head) Star Drive 22mm
- LS2724STAR24** Locking 2.7mm Screw (2.4 Head) Star Drive 24mm
- LS2724STAR26** Locking 2.7mm Screw (2.4 Head) Star Drive 26mm
- LS2724STAR28** Locking 2.7mm Screw (2.4 Head) Star Drive 28mm
- LS2724STAR30** Locking 2.7mm Screw (2.4 Head) Star Drive 30mm
- LS2724STAR32** Locking 2.7mm Screw (2.4 Head) Star Drive 32mm
- LS2724STAR34** Locking 2.7mm Screw (2.4 Head) Star Drive 34mm
- LS2724STAR36** Locking 2.7mm Screw (2.4 Head) Star Drive 36mm
- LS2724STAR38** Locking 2.7mm Screw (2.4 Head) Star Drive 38mm
- LS2724STAR40** Locking 2.7mm Screw (2.4 Head) Star Drive 40mm

3.5mm Locking Screws Star Drive

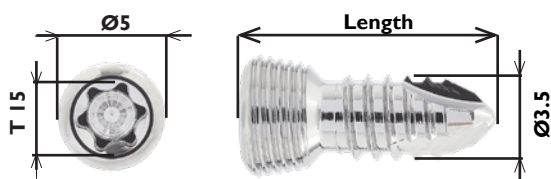

pilot drill - 2.8mm

- LS35STAR10** Locking 3.5mm Screw Star Drive 10mm
- LS35STAR12** Locking 3.5mm Screw Star Drive 12mm
- LS35STAR14** Locking 3.5mm Screw Star Drive 14mm
- LS35STAR16** Locking 3.5mm Screw Star Drive 16mm
- LS35STAR18** Locking 3.5mm Screw Star Drive 18mm
- LS35STAR20** Locking 3.5mm Screw Star Drive 20mm
- LS35STAR22** Locking 3.5mm Screw Star Drive 22mm
- LS35STAR24** Locking 3.5mm Screw Star Drive 24mm
- LS35STAR26** Locking 3.5mm Screw Star Drive 26mm
- LS35STAR28** Locking 3.5mm Screw Star Drive 28mm
- LS35STAR30** Locking 3.5mm Screw Star Drive 30mm
- LS35STAR32** Locking 3.5mm Screw Star Drive 32mm
- LS35STAR34** Locking 3.5mm Screw Star Drive 34mm
- LS35STAR36** Locking 3.5mm Screw Star Drive 36mm
- LS35STAR38** Locking 3.5mm Screw Star Drive 38mm
- LS35STAR40** Locking 3.5mm Screw Star Drive 40mm
- LS35STAR42** Locking 3.5mm Screw Star Drive 42mm
- LS35STAR44** Locking 3.5mm Screw Star Drive 44mm
- LS35STAR45** Locking 3.5mm Screw Star Drive 45mm
- LS35STAR46** Locking 3.5mm Screw Star Drive 46mm
- LS35STAR48** Locking 3.5mm Screw Star Drive 48mm
- LS35STAR50** Locking 3.5mm Screw Star Drive 50mm
- LS35STAR52** Locking 3.5mm Screw Star Drive 52mm
- LS35STAR54** Locking 3.5mm Screw Star Drive 54mm
- LS35STAR56** Locking 3.5mm Screw Star Drive 56mm
- LS35STAR58** Locking 3.5mm Screw Star Drive 58mm
- LS35STAR60** Locking 3.5mm Screw Star Drive 60mm

Locking Plugs

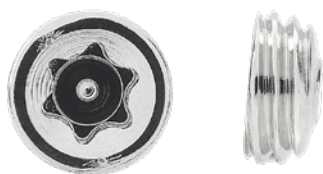

Use to protect locking holes during contouring.

- LSP15STAR** Locking Plug For LS15STAR** Screws
- LSP20STAR** Locking Plug For LS20STAR** Screws
- LSP24STAR** Locking Plug For LS2724STAR** & LS2424STAR** Screws
- LSP35STAR** Locking Plug For LS35STAR** Screws
- LSP35** Locking Plug For LS35** Hex Drive Screws

3.5mm Locking Screws Hex Drive

pilot drill - 2.8mm

- LS3510** Locking 3.5mm Screw Hex Drive 10mm
- LS3512** Locking 3.5mm Screw Hex Drive 12mm
- LS3514** Locking 3.5mm Screw Hex Drive 14mm
- LS3516** Locking 3.5mm Screw Hex Drive 16mm
- LS3518** Locking 3.5mm Screw Hex Drive 18mm
- LS3520** Locking 3.5mm Screw Hex Drive 20mm
- LS3522** Locking 3.5mm Screw Hex Drive 22mm
- LS3524** Locking 3.5mm Screw Hex Drive 24mm
- LS3526** Locking 3.5mm Screw Hex Drive 26mm
- LS3528** Locking 3.5mm Screw Hex Drive 28mm
- LS3530** Locking 3.5mm Screw Hex Drive 30mm
- LS3532** Locking 3.5mm Screw Hex Drive 32mm
- LS3534** Locking 3.5mm Screw Hex Drive 34mm
- LS3536** Locking 3.5mm Screw Hex Drive 36mm
- LS3538** Locking 3.5mm Screw Hex Drive 38mm
- LS3540** Locking 3.5mm Screw Hex Drive 40mm
- LS3542** Locking 3.5mm Screw Hex Drive 42mm
- LS3544** Locking 3.5mm Screw Hex Drive 44mm
- LS3545** Locking 3.5mm Screw Hex Drive 45mm
- LS3546** Locking 3.5mm Screw Hex Drive 46mm
- LS3548** Locking 3.5mm Screw Hex Drive 48mm
- LS3550** Locking 3.5mm Screw Hex Drive 50mm
- LS3552** Locking 3.5mm Screw Hex Drive 52mm
- LS3554** Locking 3.5mm Screw Hex Drive 54mm
- LS3555** Locking 3.5mm Screw Hex Drive 55mm
- LS3556** Locking 3.5mm Screw Hex Drive 56mm
- LS3558** Locking 3.5mm Screw Hex Drive 58mm
- LS3560** Locking 3.5mm Screw Hex Drive 60mm

Locking Screw Sets



Star Drive Locking Screw Sets in Modular Plating Box Screw Caddy.

- LS15STARKITMPB** 1.5 Star Drive Locking Screw Set
- LS20STARKITMPB** 2.0 Star Drive Locking Screw Set
- LS24STARKITMPB** 2.4 Star Drive Locking Screw Set
- LS27STARKITMPB** 2.7 Star Drive Locking Screw Set
- LS35STARKITMPB** 3.5 Star Drive Locking Screw Set

1.5mm Screws

1.5mm Cortical Self Tapping Screws

Star Drive

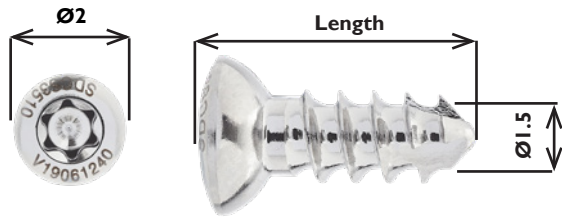

pilot drill - 1.1mm

- SDCSI506** 1.5mm Cortical Self Tapping Screw 6mm Star Drive
- SDCSI507** 1.5mm Cortical Self Tapping Screw 7mm Star Drive
- SDCSI508** 1.5mm Cortical Self Tapping Screw 8mm Star Drive
- SDCSI509** 1.5mm Cortical Self Tapping Screw 9mm Star Drive
- SDCSI510** 1.5mm Cortical Self Tapping Screw 10mm Star Drive
- SDCSI511** 1.5mm Cortical Self Tapping Screw 11mm Star Drive
- SDCSI512** 1.5mm Cortical Self Tapping Screw 12mm Star Drive
- SDCSI514** 1.5mm Cortical Self Tapping Screw 14mm Star Drive
- SDCSI516** 1.5mm Cortical Self Tapping Screw 16mm Star Drive
- SDCSI518** 1.5mm Cortical Self Tapping Screw 18mm Star Drive
- SDCSI520** 1.5mm Cortical Self Tapping Screw 20mm Star Drive
- SDCSI522** 1.5mm Cortical Self Tapping Screw 22mm Star Drive
- SDCSI524** 1.5mm Cortical Self Tapping Screw 24mm Star Drive

1.5mm Cortical Self Tapping Screws

Hex Drive



pilot drill - 1.1mm

- CSST1506** 1.5mm Cortical Self Tapping Screw 6mm
- CSST1507** 1.5mm Cortical Self Tapping Screw 7mm
- CSST1508** 1.5mm Cortical Self Tapping Screw 8mm
- CSST1509** 1.5mm Cortical Self Tapping Screw 9mm
- CSST1510** 1.5mm Cortical Self Tapping Screw 10mm
- CSST1511** 1.5mm Cortical Self Tapping Screw 11mm
- CSST1512** 1.5mm Cortical Self Tapping Screw 12mm
- CSST1514** 1.5mm Cortical Self Tapping Screw 14mm
- CSST1516** 1.5mm Cortical Self Tapping Screw 16mm
- CSST1518** 1.5mm Cortical Self Tapping Screw 18mm
- CSST1520** 1.5mm Cortical Self Tapping Screw 20mm
- CSST1522** 1.5mm Cortical Self Tapping Screw 22mm
- CSST1524** 1.5mm Cortical Self Tapping Screw 24mm

1.5mm Cortical Screws

Hex Drive

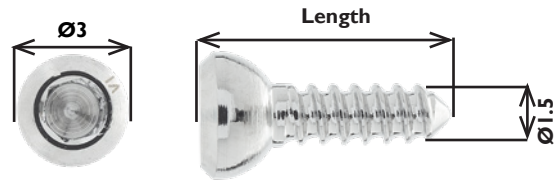

pilot drill - 1.1mm

- CSI506** 1.5mm Cortical Screw 6mm
- CSI507** 1.5mm Cortical Screw 7mm
- CSI508** 1.5mm Cortical Screw 8mm
- CSI509** 1.5mm Cortical Screw 9mm
- CSI510** 1.5mm Cortical Screw 10mm
- CSI511** 1.5mm Cortical Screw 11mm
- CSI512** 1.5mm Cortical Screw 12mm
- CSI514** 1.5mm Cortical Screw 14mm
- CSI516** 1.5mm Cortical Screw 16mm
- CSI518** 1.5mm Cortical Screw 18mm
- CSI520** 1.5mm Cortical Screw 20mm
- CSI522** 1.5mm Cortical Screw 22mm
- CSI524** 1.5mm Cortical Screw 24mm
- CSI526** 1.5mm Cortical Screw 26mm
- CSI528** 1.5mm Cortical Screw 28mm
- CSI530** 1.5mm Cortical Screw 30mm
- CSI532** 1.5mm Cortical Screw 32mm
- CSI534** 1.5mm Cortical Screw 34mm

2.0mm Screws

2.0mm Cortical Self Tapping Screws

Star Drive

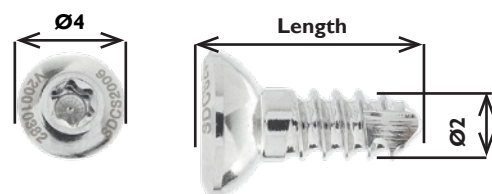

pilot drill - 1.5mm

- SDCS2006** Cortical Screw Star Drive 2.0mm Length 06mm Self-Tap
- SDCS2007** Cortical Screw Star Drive 2.0mm Length 07mm Self-Tap
- SDCS2008** Cortical Screw Star Drive 2.0mm Length 08mm Self-Tap
- SDCS2009** Cortical Screw Star Drive 2.0mm Length 09mm Self-Tap
- SDCS2010** Cortical Screw Star Drive 2.0mm Length 10mm Self-Tap
- SDCS2011** Cortical Screw Star Drive 2.0mm Length 11mm Self-Tap
- SDCS2012** Cortical Screw Star Drive 2.0mm Length 12mm Self-Tap
- SDCS2014** Cortical Screw Star Drive 2.0mm Length 14mm Self-Tap
- SDCS2016** Cortical Screw Star Drive 2.0mm Length 16mm Self-Tap
- SDCS2018** Cortical Screw Star Drive 2.0mm Length 18mm Self-Tap
- SDCS2020** Cortical Screw Star Drive 2.0mm Length 20mm Self-Tap
- SDCS2022** Cortical Screw Star Drive 2.0mm Length 22mm Self-Tap
- SDCS2024** Cortical Screw Star Drive 2.0mm Length 24mm Self-Tap
- SDCS2026** Cortical Screw Star Drive 2.0mm Length 26mm Self-Tap
- SDCS2028** Cortical Screw Star Drive 2.0mm Length 28mm Self-Tap
- SDCS2030** Cortical Screw Star Drive 2.0mm Length 30mm Self-Tap
- SDCS2032** Cortical Screw Star Drive 2.0mm Length 32mm Self-Tap
- SDCS2034** Cortical Screw Star Drive 2.0mm Length 34mm Self-Tap
- SDCS2036** Cortical Screw Star Drive 2.0mm Length 36mm Self-Tap
- SDCS2038** Cortical Screw Star Drive 2.0mm Length 38mm Self-Tap
- SDCS2040** Cortical Screw Star Drive 2.0mm Length 40mm Self-Tap

2.0mm Cortical Self Tapping Screws Hex Drive

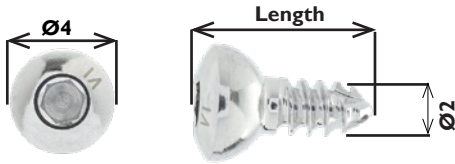

pilot drill - 1.5mm

CSST2006	2mm Cortical Self Tapping Screw 6mm
CSST2007	2mm Cortical Self Tapping Screw 7mm
CSST2008	2mm Cortical Self Tapping Screw 8mm
CSST2009	2mm Cortical Self Tapping Screw 9mm
CSST2010	2mm Cortical Self Tapping Screw 10mm
CSST2011	2mm Cortical Self Tapping Screw 11mm
CSST2012	2mm Cortical Self Tapping Screw 12mm
CSST2014	2mm Cortical Self Tapping Screw 14mm
CSST2016	2mm Cortical Self Tapping Screw 16mm
CSST2018	2mm Cortical Self Tapping Screw 18mm
CSST2020	2mm Cortical Self Tapping Screw 20mm
CSST2022	2mm Cortical Self Tapping Screw 22mm
CSST2024	2mm Cortical Self Tapping Screw 24mm
CSST2026	2mm Cortical Self Tapping Screw 26mm
CSST2028	2mm Cortical Self Tapping Screw 28mm
CSST2030	2mm Cortical Self Tapping Screw 30mm
CSST2032	2mm Cortical Self Tapping Screw 32mm
CSST2034	2mm Cortical Self Tapping Screw 34mm
CSST2036	2mm Cortical Self Tapping Screw 36mm
CSST2038	2mm Cortical Self Tapping Screw 38mm
CSST2040	2mm Cortical Self Tapping Screw 40mm

2.0mm Cortical Screws Hex Drive

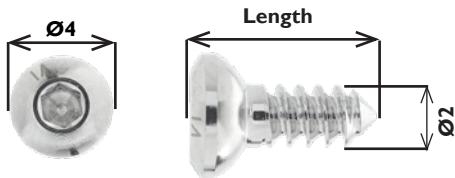

pilot drill - 1.5mm

CS2006	2mm Cortical Screw 6mm
CS2007	2mm Cortical Screw 7mm
CS2008	2mm Cortical Screw 8mm
CS2009	2mm Cortical Screw 9mm
CS2010	2mm Cortical Screw 10mm
CS2011	2mm Cortical Screw 11mm
CS2012	2mm Cortical Screw 12mm
CS2014	2mm Cortical Screw 14mm
CS2016	2mm Cortical Screw 16mm
CS2018	2mm Cortical Screw 18mm
CS2020	2mm Cortical Screw 20mm
CS2022	2mm Cortical Screw 22mm
CS2024	2mm Cortical Screw 24mm
CS2026	2mm Cortical Screw 26mm
CS2028	2mm Cortical Screw 28mm
CS2030	2mm Cortical Screw 30mm
CS2032	2mm Cortical Screw 32mm
CS2034	2mm Cortical Screw 34mm

2.4mm Screws 2.4mm Cortical Self Tapping Screws Star Drive

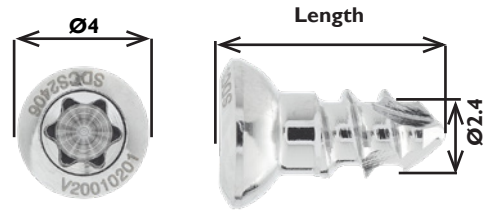

pilot drill - 1.8mm

SDCS2406	2.4mm Cortical Self Tapping Screw 6mm Star Drive
SDCS2407	2.4mm Cortical Self Tapping Screw 7mm Star Drive
SDCS2408	2.4mm Cortical Self Tapping Screw 8mm Star Drive
SDCS2409	2.4mm Cortical Self Tapping Screw 9mm Star Drive
SDCS2410	2.4mm Cortical Self Tapping Screw 10mm Star Drive
SDCS2411	2.4mm Cortical Self Tapping Screw 11mm Star Drive
SDCS2412	2.4mm Cortical Self Tapping Screw 12mm Star Drive
SDCS2414	2.4mm Cortical Self Tapping Screw 14mm Star Drive
SDCS2416	2.4mm Cortical Self Tapping Screw 16mm Star Drive
SDCS2418	2.4mm Cortical Self Tapping Screw 18mm Star Drive
SDCS2420	2.4mm Cortical Self Tapping Screw 20mm Star Drive
SDCS2422	2.4mm Cortical Self Tapping Screw 22mm Star Drive
SDCS2424	2.4mm Cortical Self Tapping Screw 24mm Star Drive
SDCS2426	2.4mm Cortical Self Tapping Screw 26mm Star Drive
SDCS2428	2.4mm Cortical Self Tapping Screw 28mm Star Drive
SDCS2430	2.4mm Cortical Self Tapping Screw 30mm Star Drive
SDCS2432	2.4mm Cortical Self Tapping Screw 32mm Star Drive
SDCS2434	2.4mm Cortical Self Tapping Screw 34mm Star Drive
SDCS2436	2.4mm Cortical Self Tapping Screw 36mm Star Drive
SDCS2438	2.4mm Cortical Self Tapping Screw 38mm Star Drive
SDCS2440	2.4mm Cortical Self Tapping Screw 40mm Star Drive

2.4mm Cortical Self Tapping Screws Hex Drive

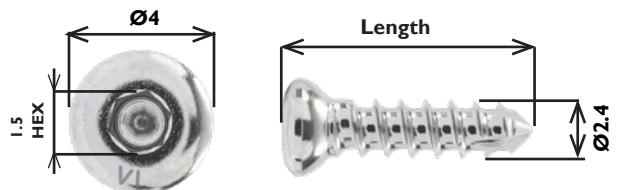

pilot drill - 1.8mm

CSST2406	2.4mm Self Tapping Cortical Screw 6mm
CSST2407	2.4mm Self Tapping Cortical Screw 7mm
CSST2408	2.4mm Self Tapping Cortical Screw 8mm
CSST2409	2.4mm Self Tapping Cortical Screw 9mm
CSST2410	2.4mm Self Tapping Cortical Screw 10mm
CSST2411	2.4mm Self Tapping Cortical Screw 11mm
CSST2412	2.4mm Self Tapping Cortical Screw 12mm
CSST2414	2.4mm Self Tapping Cortical Screw 14mm
CSST2416	2.4mm Self Tapping Cortical Screw 16mm
CSST2418	2.4mm Self Tapping Cortical Screw 18mm
CSST2420	2.4mm Self Tapping Cortical Screw 20mm
CSST2422	2.4mm Self Tapping Cortical Screw 22mm
CSST2424	2.4mm Self Tapping Cortical Screw 24mm
CSST2426	2.4mm Self Tapping Cortical Screw 26mm
CSST2428	2.4mm Self Tapping Cortical Screw 28mm
CSST2430	2.4mm Self Tapping Cortical Screw 30mm
CSST2432	2.4mm Self Tapping Cortical Screw 32mm
CSST2434	2.4mm Self Tapping Cortical Screw 34mm
CSST2436	2.4mm Self Tapping Cortical Screw 36mm
CSST2438	2.4mm Self Tapping Cortical Screw 38mm
CSST2440	2.4mm Self Tapping Cortical Screw 40mm

2.7mm Screws

2.7mm Cortical Self Tapping Screws

Star Drive

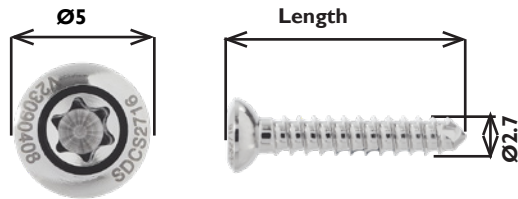

pilot drill - 2.0mm

- SDCS2706** 2.7mm Cortical Self Tapping Screw 6mm Star Drive
- SDCS2707** 2.7mm Cortical Self Tapping Screw 7mm Star Drive
- SDCS2708** 2.7mm Cortical Self Tapping Screw 8mm Star Drive
- SDCS2709** 2.7mm Cortical Self Tapping Screw 9mm Star Drive
- SDCS2710** 2.7mm Cortical Self Tapping Screw 10mm Star Drive
- SDCS2711** 2.7mm Cortical Self Tapping Screw 11mm Star Drive
- SDCS2712** 2.7mm Cortical Self Tapping Screw 12mm Star Drive
- SDCS2714** 2.7mm Cortical Self Tapping Screw 14mm Star Drive
- SDCS2716** 2.7mm Cortical Self Tapping Screw 16mm Star Drive
- SDCS2718** 2.7mm Cortical Self Tapping Screw 18mm Star Drive
- SDCS2720** 2.7mm Cortical Self Tapping Screw 20mm Star Drive
- SDCS2722** 2.7mm Cortical Self Tapping Screw 22mm Star Drive
- SDCS2724** 2.7mm Cortical Self Tapping Screw 24mm Star Drive
- SDCS2726** 2.7mm Cortical Self Tapping Screw 26mm Star Drive
- SDCS2728** 2.7mm Cortical Self Tapping Screw 28mm Star Drive
- SDCS2730** 2.7mm Cortical Self Tapping Screw 30mm Star Drive
- SDCS2732** 2.7mm Cortical Self Tapping Screw 32mm Star Drive
- SDCS2734** 2.7mm Cortical Self Tapping Screw 34mm Star Drive
- SDCS2736** 2.7mm Cortical Self Tapping Screw 36mm Star Drive
- SDCS2738** 2.7mm Cortical Self Tapping Screw 38mm Star Drive
- SDCS2740** 2.7mm Cortical Self Tapping Screw 40mm Star Drive

2.7mm Cortical Screws

Hex Drive

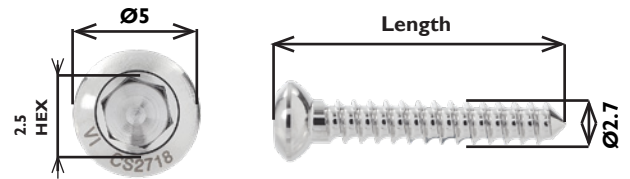

pilot drill - 2.0mm

- | | |
|---|---|
| CS2706 2.7mm Cortical Screw 6mm | CS2720 2.7mm Cortical Screw 20mm |
| CS2707 2.7mm Cortical Screw 7mm | CS2722 2.7mm Cortical Screw 22mm |
| CS2708 2.7mm Cortical Screw 8mm | CS2724 2.7mm Cortical Screw 24mm |
| CS2709 2.7mm Cortical Screw 9mm | CS2726 2.7mm Cortical Screw 26mm |
| CS2710 2.7mm Cortical Screw 10mm | CS2728 2.7mm Cortical Screw 28mm |
| CS2711 2.7mm Cortical Screw 11mm | CS2730 2.7mm Cortical Screw 30mm |
| CS2712 2.7mm Cortical Screw 12mm | CS2732 2.7mm Cortical Screw 32mm |
| CS2713 2.7mm Cortical Screw 13mm | CS2734 2.7mm Cortical Screw 34mm |
| CS2714 2.7mm Cortical Screw 14mm | CS2736 2.7mm Cortical Screw 36mm |
| CS2716 2.7mm Cortical Screw 16mm | CS2738 2.7mm Cortical Screw 38mm |
| CS2718 2.7mm Cortical Screw 18mm | CS2740 2.7mm Cortical Screw 40mm |

2.7mm Cortical Self Tapping Screws

Hex Drive

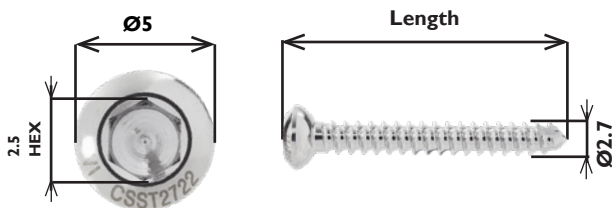

pilot drill - 2.0mm

- CSST2706** 2.7mm Cortical Self Tapping Screw 6mm
- CSST2708** 2.7mm Cortical Self Tapping Screw 8mm
- CSST2709** 2.7mm Cortical Self Tapping Screw 9mm
- CSST2710** 2.7mm Cortical Self Tapping Screw 10mm
- CSST2711** 2.7mm Cortical Self Tapping Screw 11mm
- CSST2712** 2.7mm Cortical Self Tapping Screw 12mm
- CSST2714** 2.7mm Cortical Self Tapping Screw 14mm
- CSST2716** 2.7mm Cortical Self Tapping Screw 16mm
- CSST2718** 2.7mm Cortical Self Tapping Screw 18mm
- CSST2720** 2.7mm Cortical Self Tapping Screw 20mm
- CSST2722** 2.7mm Cortical Self Tapping Screw 22mm
- CSST2724** 2.7mm Cortical Self Tapping Screw 24mm
- CSST2726** 2.7mm Cortical Self Tapping Screw 26mm
- CSST2728** 2.7mm Cortical Self Tapping Screw 28mm
- CSST2730** 2.7mm Cortical Self Tapping Screw 30mm
- CSST2732** 2.7mm Cortical Self Tapping Screw 32mm
- CSST2734** 2.7mm Cortical Self Tapping Screw 34mm
- CSST2736** 2.7mm Cortical Self Tapping Screw 36mm
- CSST2738** 2.7mm Cortical Self Tapping Screw 38mm
- CSST2740** 2.7mm Cortical Self Tapping Screw 40mm

3.5mm Screws

3.5mm Cortical Self Tapping Screws

Star Drive

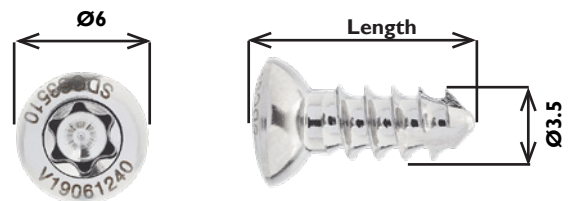

pilot drill - 2.5mm

- SDCS3508** 3.5mm Cortical Self Tapping Screw 8mm Star Drive
- SDCS3509** 3.5mm Cortical Self Tapping Screw 9mm Star Drive
- SDCS3510** 3.5mm Cortical Self Tapping Screw 10mm Star Drive
- SDCS3511** 3.5mm Cortical Self Tapping Screw 11mm Star Drive
- SDCS3512** 3.5mm Cortical Self Tapping Screw 12mm Star Drive
- SDCS3513** 3.5mm Cortical Self Tapping Screw 13mm Star Drive
- SDCS3514** 3.5mm Cortical Self Tapping Screw 14mm Star Drive
- SDCS3515** 3.5mm Cortical Self Tapping Screw 15mm Star Drive
- SDCS3516** 3.5mm Cortical Self Tapping Screw 16mm Star Drive
- SDCS3518** 3.5mm Cortical Self Tapping Screw 18mm Star Drive
- SDCS3520** 3.5mm Cortical Self Tapping Screw 20mm Star Drive
- SDCS3522** 3.5mm Cortical Self Tapping Screw 22mm Star Drive
- SDCS3524** 3.5mm Cortical Self Tapping Screw 24mm Star Drive
- SDCS3526** 3.5mm Cortical Self Tapping Screw 26mm Star Drive
- SDCS3528** 3.5mm Cortical Self Tapping Screw 28mm Star Drive
- SDCS3530** 3.5mm Cortical Self Tapping Screw 30mm Star Drive
- SDCS3532** 3.5mm Cortical Self Tapping Screw 32mm Star Drive
- SDCS3534** 3.5mm Cortical Self Tapping Screw 34mm Star Drive
- SDCS3536** 3.5mm Cortical Self Tapping Screw 36mm Star Drive
- SDCS3538** 3.5mm Cortical Self Tapping Screw 38mm Star Drive
- SDCS3540** 3.5mm Cortical Self Tapping Screw 40mm Star Drive
- SDCS3542** 3.5mm Cortical Self Tapping Screw 42mm Star Drive
- SDCS3544** 3.5mm Cortical Self Tapping Screw 44mm Star Drive
- SDCS3545** 3.5mm Cortical Self Tapping Screw 45mm Star Drive
- SDCS3546** 3.5mm Cortical Self Tapping Screw 46mm Star Drive
- SDCS3548** 3.5mm Cortical Self Tapping Screw 48mm Star Drive
- SDCS3550** 3.5mm Cortical Self Tapping Screw 50mm Star Drive
- SDCS3555** 3.5mm Cortical Self Tapping Screw 55mm Star Drive
- SDCS3560** 3.5mm Cortical Self Tapping Screw 60mm Star Drive

3.5mm Cortical Self Tapping Screws Hex Drive

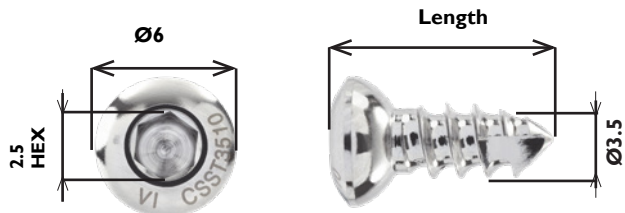

pilot drill - 2.5mm

- CSST3508** 3.5mm Self Tapping Cortical Screw 8mm
- CSST3510** 3.5mm Self Tapping Cortical Screw 10mm
- CSST3511** 3.5mm Self Tapping Cortical Screw 11mm
- CSST3512** 3.5mm Self Tapping Cortical Screw 12mm
- CSST3514** 3.5mm Self Tapping Cortical Screw 14mm
- CSST3516** 3.5mm Self Tapping Cortical Screw 16mm
- CSST3518** 3.5mm Self Tapping Cortical Screw 18mm
- CSST3520** 3.5mm Self Tapping Cortical Screw 20mm
- CSST3522** 3.5mm Self Tapping Cortical Screw 22mm
- CSST3524** 3.5mm Self Tapping Cortical Screw 24mm
- CSST3526** 3.5mm Self Tapping Cortical Screw 26mm
- CSST3528** 3.5mm Self Tapping Cortical Screw 28mm
- CSST3530** 3.5mm Self Tapping Cortical Screw 30mm
- CSST3532** 3.5mm Self Tapping Cortical Screw 32mm
- CSST3534** 3.5mm Self Tapping Cortical Screw 34mm
- CSST3536** 3.5mm Self Tapping Cortical Screw 36mm
- CSST3538** 3.5mm Self Tapping Cortical Screw 38mm
- CSST3540** 3.5mm Self Tapping Cortical Screw 40mm
- CSST3542** 3.5mm Self Tapping Cortical Screw 42mm
- CSST3544** 3.5mm Self Tapping Cortical Screw 44mm
- CSST3545** 3.5mm Self Tapping Cortical Screw 45mm
- CSST3546** 3.5mm Self Tapping Cortical Screw 46mm
- CSST3548** 3.5mm Self Tapping Cortical Screw 48mm
- CSST3550** 3.5mm Self Tapping Cortical Screw 50mm
- CSST3555** 3.5mm Self Tapping Cortical Screw 55mm
- CSST3560** 3.5mm Self Tapping Cortical Screw 60mm

3.5mm Cortical Screws Hex Drive

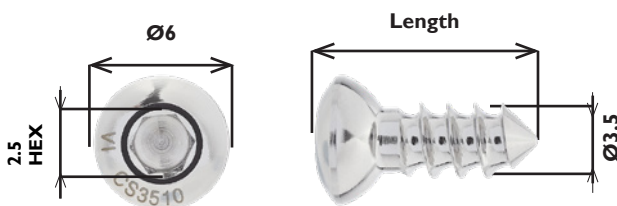

pilot drill - 2.5mm

- CS3508** 3.5mm Cortical Screw 8mm
- CS3510** 3.5mm Cortical Screw 10mm
- CS3512** 3.5mm Cortical Screw 12mm
- CS3514** 3.5mm Cortical Screw 14mm
- CS3515** 3.5mm Cortical Screw 15mm
- CS3516** 3.5mm Cortical Screw 16mm
- CS3518** 3.5mm Cortical Screw 18mm
- CS3520** 3.5mm Cortical Screw 20mm
- CS3522** 3.5mm Cortical Screw 22mm
- CS3524** 3.5mm Cortical Screw 24mm
- CS3526** 3.5mm Cortical Screw 26mm
- CS3528** 3.5mm Cortical Screw 28mm
- CS3530** 3.5mm Cortical Screw 30mm
- CS3532** 3.5mm Cortical Screw 32mm
- CS3534** 3.5mm Cortical Screw 34mm
- CS3536** 3.5mm Cortical Screw 36mm
- CS3538** 3.5mm Cortical Screw 38mm
- CS3540** 3.5mm Cortical Screw 40mm
- CS3542** 3.5mm Cortical Screw 42mm
- CS3544** 3.5mm Cortical Screw 44mm
- CS3545** 3.5mm Cortical Screw 45mm
- CS3546** 3.5mm Cortical Screw 46mm
- CS3548** 3.5mm Cortical Screw 48mm
- CS3550** 3.5mm Cortical Screw 50mm
- CS3555** 3.5mm Cortical Screw 55mm
- CS3560** 3.5mm Cortical Screw 60mm
- CS3565** 3.5mm Cortical Screw 65mm
- CS3570** 3.5mm Cortical Screw 70mm
- CS3580** 3.5mm Cortical Screw 80mm
- CS3585** 3.5mm Cortical Screw 85mm



Loan Kits

For a nominal fee, we have a range of **specialist loan kits** available to complement your own fleet. With next working day availability, the service offers flexibility as procedures are booked with your clients.

To find out more, scan the QR code below.



4.5mm Screws

4.5mm Cortical Self Tapping Screws

Hex Drive

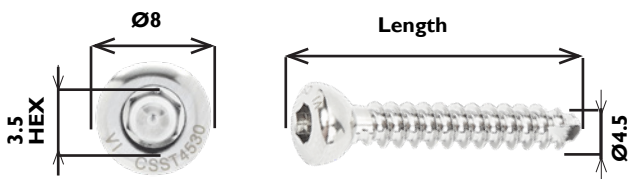

pilot drill - 3.2mm

CSST4512	4.5mm Self Tapping Cortical Screw 12mm
CSST4514	4.5mm Self Tapping Cortical Screw 14mm
CSST4516	4.5mm Self Tapping Cortical Screw 16mm
CSST4518	4.5mm Self Tapping Cortical Screw 18mm
CSST4520	4.5mm Self Tapping Cortical Screw 20mm
CSST4522	4.5mm Self Tapping Cortical Screw 22mm
CSST4524	4.5mm Self Tapping Cortical Screw 24mm
CSST4526	4.5mm Self Tapping Cortical Screw 26mm
CSST4528	4.5mm Self Tapping Cortical Screw 28mm
CSST4530	4.5mm Self Tapping Cortical Screw 30mm
CSST4532	4.5mm Self Tapping Cortical Screw 32mm
CSST4534	4.5mm Self Tapping Cortical Screw 34mm
CSST4536	4.5mm Self Tapping Cortical Screw 36mm
CSST4538	4.5mm Self Tapping Cortical Screw 38mm
CSST4540	4.5mm Self Tapping Cortical Screw 40mm
CSST4542	4.5mm Self Tapping Cortical Screw 42mm
CSST4544	4.5mm Self Tapping Cortical Screw 44mm
CSST4546	4.5mm Self Tapping Cortical Screw 46mm
CSST4548	4.5mm Self Tapping Cortical Screw 48mm
CSST4550	4.5mm Self Tapping Cortical Screw 50mm
CSST4552	4.5mm Self Tapping Cortical Screw 52mm
CSST4554	4.5mm Self Tapping Cortical Screw 54mm
CSST4556	4.5mm Self Tapping Cortical Screw 56mm
CSST4558	4.5mm Self Tapping Cortical Screw 58mm
CSST4560	4.5mm Self Tapping Cortical Screw 60mm
CSST4562	4.5mm Self Tapping Cortical Screw 62mm
CSST4564	4.5mm Self Tapping Cortical Screw 64mm
CSST4566	4.5mm Self Tapping Cortical Screw 66mm
CSST4568	4.5mm Self Tapping Cortical Screw 68mm
CSST4570	4.5mm Self Tapping Cortical Screw 70mm
CSST4575	4.5mm Self Tapping Cortical Screw 75mm
CSST4580	4.5mm Self Tapping Cortical Screw 80mm
CSST4585	4.5mm Self Tapping Cortical Screw 85mm

4.5mm Cortical Screws

Hex Drive

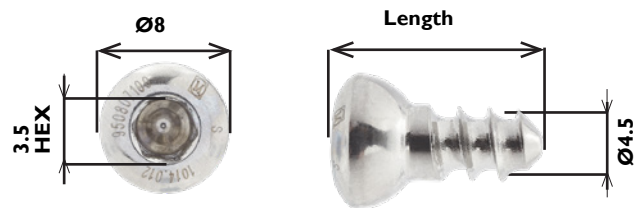

pilot drill - 3.2mm

CS4512	4.5mm Cortical Screw 12mm
CS4514	4.5mm Cortical Screw 14mm
CS4516	4.5mm Cortical Screw 16mm
CS4518	4.5mm Cortical Screw 18mm
CS4520	4.5mm Cortical Screw 20mm
CS4522	4.5mm Cortical Screw 22mm
CS4524	4.5mm Cortical Screw 24mm
CS4526	4.5mm Cortical Screw 26mm
CS4528	4.5mm Cortical Screw 28mm
CS4530	4.5mm Cortical Screw 30mm
CS4532	4.5mm Cortical Screw 32mm
CS4534	4.5mm Cortical Screw 34mm
CS4536	4.5mm Cortical Screw 36mm
CS4538	4.5mm Cortical Screw 38mm
CS4540	4.5mm Cortical Screw 40mm
CS4542	4.5mm Cortical Screw 42mm
CS4544	4.5mm Cortical Screw 44mm
CS4546	4.5mm Cortical Screw 46mm
CS4548	4.5mm Cortical Screw 48mm
CS4550	4.5mm Cortical Screw 50mm
CS4552	4.5mm Cortical Screw 52mm
CS4554	4.5mm Cortical Screw 54mm
CS4556	4.5mm Cortical Screw 56mm
CS4558	4.5mm Cortical Screw 58mm
CS4560	4.5mm Cortical Screw 60mm
CS4562	4.5mm Cortical Screw 62mm
CS4564	4.5mm Cortical Screw 64mm
CS4566	4.5mm Cortical Screw 66mm
CS4568	4.5mm Cortical Screw 68mm
CS4570	4.5mm Cortical Screw 70mm
CS4575	4.5mm Cortical Screw 75mm
CS4580	4.5mm Cortical Screw 80mm
CS4585	4.5mm Cortical Screw 85mm

5.5mm Screws

5.5mm Cortical Screws

Hex Drive

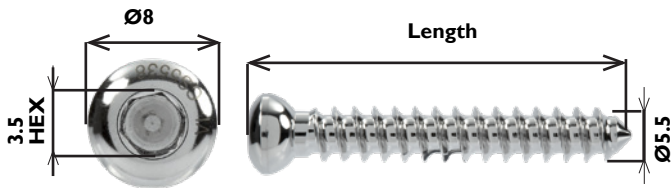

pilot drill - 4.0mm

CS5524	5.5mm Cortical Screw 24mm
CS5526	5.5mm Cortical Screw 26mm
CS5528	5.5mm Cortical Screw 28mm
CS5530	5.5mm Cortical Screw 30mm
CS5532	5.5mm Cortical Screw 32mm
CS5534	5.5mm Cortical Screw 34mm
CS5536	5.5mm Cortical Screw 36mm
CS5538	5.5mm Cortical Screw 38mm
CS5540	5.5mm Cortical Screw 40mm
CS5542	5.5mm Cortical Screw 42mm
CS5544	5.5mm Cortical Screw 44mm
CS5546	5.5mm Cortical Screw 46mm
CS5548	5.5mm Cortical Screw 48mm
CS5550	5.5mm Cortical Screw 50mm
CS5552	5.5mm Cortical Screw 52mm
CS5554	5.5mm Cortical Screw 54mm
CS5556	5.5mm Cortical Screw 56mm
CS5560	5.5mm Cortical Screw 60mm
CS5564	5.5mm Cortical Screw 64mm
CS5570	5.5mm Cortical Screw 70mm
CS5580	5.5mm Cortical Screw 80mm
CS5590	5.5mm Cortical Screw 90mm
CS55100	5.5mm Cortical Screw 100mm



ViPP

Through a true partnership approach, you can deliver quantifiable rewards for you and your Practice by joining our **Veterinary Instrumentation Partnership Programme**.

To find out more, scan the QR code below.



Cancellous Screws

Hex Drive

2.2mm Cancellous Screws

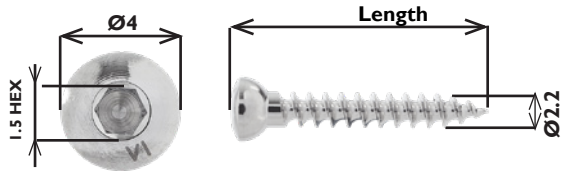

pilot drill - 1.5mm

CAN2208	2.2mm Self Tapping Cancellous Screw 8mm
CAN2210	2.2mm Self Tapping Cancellous Screw 10mm
CAN2212	2.2mm Self Tapping Cancellous Screw 12mm
CAN2214	2.2mm Self Tapping Cancellous Screw 14mm
CAN2216	2.2mm Self Tapping Cancellous Screw 16mm
CAN2218	2.2mm Self Tapping Cancellous Screw 18mm
CAN2220	2.2mm Self Tapping Cancellous Screw 20mm
CAN2222	2.2mm Self Tapping Cancellous Screw 22mm
CAN2224	2.2mm Self Tapping Cancellous Screw 24mm

3.5mm Cancellous Screws

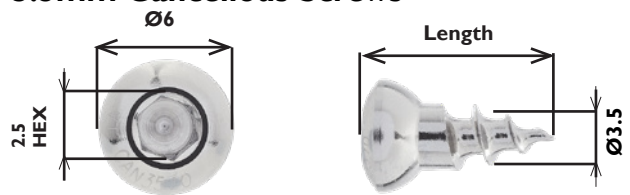

pilot drill - 2.0mm

CAN3510	3.5mm Cancellous Screw 10mm
CAN3512	3.5mm Cancellous Screw 12mm
CAN3514	3.5mm Cancellous Screw 14mm
CAN3516	3.5mm Cancellous Screw 16mm
CAN3518	3.5mm Cancellous Screw 18mm
CAN3520	3.5mm Cancellous Screw 20mm
CAN3522	3.5mm Cancellous Screw 22mm
CAN3524	3.5mm Cancellous Screw 24mm
CAN3526	3.5mm Cancellous Screw 26mm
CAN3528	3.5mm Cancellous Screw 28mm
CAN3530	3.5mm Cancellous Screw 30mm
CAN3532	3.5mm Cancellous Screw 32mm
CAN3534	3.5mm Cancellous Screw 34mm
CAN3536	3.5mm Cancellous Screw 36mm
CAN3538	3.5mm Cancellous Screw 38mm
CAN3540	3.5mm Cancellous Screw 40mm
CAN3545	3.5mm Cancellous Screw 45mm
CAN3550	3.5mm Cancellous Screw 50mm
CAN3555	3.5mm Cancellous Screw 55mm
CAN3560	3.5mm Cancellous Screw 60mm

3.0mm Cancellous Screws

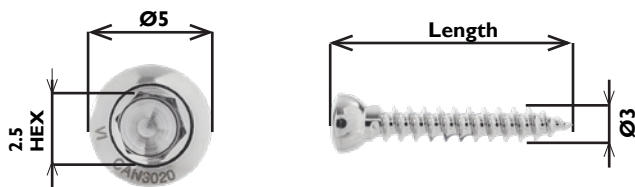

pilot drill - 2.0mm

CAN3012	3mm Self Tapping Cancellous Screw 12mm
CAN3014	3mm Self Tapping Cancellous Screw 14mm
CAN3016	3mm Self Tapping Cancellous Screw 16mm
CAN3018	3mm Self Tapping Cancellous Screw 18mm
CAN3020	3mm Self Tapping Cancellous Screw 20mm
CAN3022	3mm Self Tapping Cancellous Screw 22mm
CAN3024	3mm Self Tapping Cancellous Screw 24mm
CAN3026	3mm Self Tapping Cancellous Screw 26mm
CAN3028	3mm Self Tapping Cancellous Screw 28mm
CAN3030	3mm Self Tapping Cancellous Screw 30mm
CAN3032	3mm Self Tapping Cancellous Screw 32mm
CAN3034	3mm Self Tapping Cancellous Screw 34mm
CAN3036	3mm Self Tapping Cancellous Screw 36mm

4.0mm Cancellous Screws Part Threaded

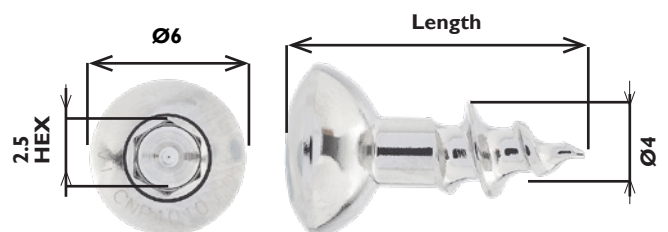

pilot drill - 2.5mm

CNP4010	4mm Part Thread Cancellous Screws 10mm
CNP4012	4mm Part Thread Cancellous Screws 12mm
CNP4014	4mm Part Thread Cancellous Screws 14mm
CNP4016	4mm Part Thread Cancellous Screws 16mm
CNP4018	4mm Part Thread Cancellous Screws 18mm
CNP4020	4mm Part Thread Cancellous Screws 20mm
CNP4022	4mm Part Thread Cancellous Screws 22mm
CNP4024	4mm Part Thread Cancellous Screws 24mm
CNP4026	4mm Part Thread Cancellous Screws 26mm
CNP4028	4mm Part Thread Cancellous Screws 28mm
CNP4030	4mm Part Thread Cancellous Screws 30mm
CNP4035	4mm Part Thread Cancellous Screws 35mm
CNP4040	4mm Part Thread Cancellous Screws 40mm
CNP4045	4mm Part Thread Cancellous Screws 45mm
CNP4050	4mm Part Thread Cancellous Screws 50mm
CNP4055	4mm Part Thread Cancellous Screws 55mm
CNP4060	4mm Part Thread Cancellous Screws 60mm

4.0mm Cancellous Screws Full Threaded

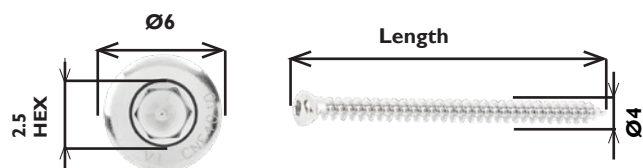

pilot drill - 2.5mm

- CNF4010 4mm Fully Threaded Cancellous Screws 10mm
- CNF4012 4mm Fully Threaded Cancellous Screws 12mm
- CNF4014 4mm Fully Threaded Cancellous Screws 14mm
- CNF4016 4mm Fully Threaded Cancellous Screws 16mm
- CNF4018 4mm Fully Threaded Cancellous Screws 18mm
- CNF4020 4mm Fully Threaded Cancellous Screws 20mm
- CNF4022 4mm Fully Threaded Cancellous Screws 22mm
- CNF4024 4mm Fully Threaded Cancellous Screws 24mm
- CNF4026 4mm Fully Threaded Cancellous Screws 26mm
- CNF4028 4mm Fully Threaded Cancellous Screws 28mm
- CNF4030 4mm Fully Threaded Cancellous Screws 30mm
- CNF4032 4mm Fully Threaded Cancellous Screws 32mm
- CNF4034 4mm Fully Threaded Cancellous Screws 34mm
- CNF4035 4mm Fully Threaded Cancellous Screws 35mm
- CNF4036 4mm Fully Threaded Cancellous Screws 36mm
- CNF4038 4mm Fully Threaded Cancellous Screws 38mm
- CNF4040 4mm Fully Threaded Cancellous Screws 40mm
- CNF4045 4mm Fully Threaded Cancellous Screws 45mm
- CNF4050 4mm Fully Threaded Cancellous Screws 50mm
- CNF4055 4mm Fully Threaded Cancellous Screws 55mm
- CNF4060 4mm Fully Threaded Cancellous Screws 60mm

6.5mm Cancellous Screws

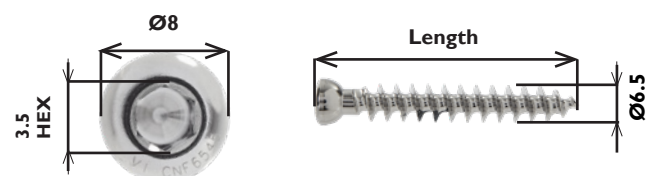

pilot drill - 3.2mm

- CNF6525 6.5mm Fully Threaded Cancellous Screws 25mm
- CNF6530 6.5mm Fully Threaded Cancellous Screws 30mm
- CNF6535 6.5mm Fully Threaded Cancellous Screws 35mm
- CNF6540 6.5mm Fully Threaded Cancellous Screws 40mm
- CNF6545 6.5mm Fully Threaded Cancellous Screws 45mm
- CNF6550 6.5mm Fully Threaded Cancellous Screws 50mm
- CNF6555 6.5mm Fully Threaded Cancellous Screws 55mm
- CNF6560 6.5mm Fully Threaded Cancellous Screws 60mm
- CNF6565 6.5mm Fully Threaded Cancellous Screws 65mm
- CNF6570 6.5mm Fully Threaded Cancellous Screws 70mm
- CNF6575 6.5mm Fully Threaded Cancellous Screws 75mm



**Screwdrivers
Modular Screwdrivers**



E17-079 Soft Touch Quick Release Handle - AO Fit



D17-080 Soft Touch Quick Release Handle - Dental Fit



DC20-A Quick Release Handle - Dental Fit

**Star Drive Screwdriver Inserts To Fit
Modular Handles**



- SDT415-A** Star Drive Insert for 1.5mm Star Drive Screws (Fits D17-080)
- SDT620-A** Star Drive Insert for 2.0mm Star Drive Screws (Fits D17-080)
- SDT82427** Star Drive Insert for 2.4/2.7mm Star Drive Screws (Fits E17-079)
- SDT1535** Star Drive Insert for 3.5mm Star Drive Screws (Fits E17-079)
- SDTSET-A** Quick Release & Dental Fit Handles & Star Drive Insert Set 1.5mm - 3.5mm

**Cruciate Drive Screwdriver Inserts To Fit
Modular Handles**



SDINI.0-A Dental Fit Screwdriver Insert For 1.0mm Screws (Fits D17-080)

**Hex Drive Screwdriver Inserts To Fit
Modular Handles**



- SDD1500-A** 1.5/2.0/2.4mm Hex Dental Fit Screwdriver Attachment (Fits D17-080)
- SDH35S** Hex Screwdriver Insert For 2.7/3.5/4.0mm Screws (Fits E17-079)
- SDHS45S** Hex Screwdriver Insert For 4.5mm+ Screws (Fits E17-079)

**Cruciate Head Screwdrivers For 1.5mm,
2.0mm & 2.4mm Screws**



- SDX1520** Cruciate Screwdriver For 1.5mm/2.0mm Screws
- SDX24** Cruciate Screwdriver 2.4mm Screws

**Hex Screwdriver For 1.5mm, 2.0mm
& 2.4mm Screws**



- SDHS20-I** 1.5mm Hex Screwdriver/Sleeve PTFE Handle For 1.5mm/2.0mm/2.4mm Screws 125mm
- SSH2000** Screw Holding Sleeve To Fit SDHS20-I

**Hex Screwdriver For 2.7mm, 3.5mm
& 4.0mm Screws**



- SDHS35POM-C** 2.5mm Hex Screwdriver + Sleeve With PTFE Handle For 2.7mm/3.5mm/4.0mm Screws, 200mm
- SSH273540** Replacement Screw Holding Sleeve To Fit SDHS35POM-C

**Hex Screwdriver For 4.5mm, 5.5mm
& 6.5mm Screws**



SDH4500 Hex Screwdriver For 4.5/5.5/6.5mm Screws Without Sleeve

Hex Drive Shaft

Hex drive screwdriver extensions for standard Jacob's Chuck on power drills. Whilst it is advised that the final tightening of the screw is performed by hand, time and effort can be saved by power driving.

- DS25HEX** 2.5 Hex Drive Shaft for 2.7mm, 3.5mm & 4.0mm Screws
- DS35HEX** 3.5 Hex Drive Shaft for 4.5mm & 5.5mm Screws

Tap Devices Modular Tap Devices



E17-079 Soft Touch Quick Release Handle - AO Fit



D17-080 Soft Touch Quick Release Handle - Dental Fit



T19-095 Soft Touch T-Bar Handle Quick Release - AO Fit

Modular Cortical Taps



- TD0015-A** 1.5mm Cortical Tap (Fits D17-080)
- TD0020-A** 2.0mm Cortical Tap (Fits D17-080)
- TS0024** 2.4mm Cortical Tap (Fits E17-079 & T19-095)
- TS00027** 2.7mm Cortical Tap (Fits E17-079 & T19-095)
- TS12535** 3.5mm Cortical Tap (Fits E17-079 & T19-095)
- TS17535** 3.5mm Small Cancellous Tap (Fits E17-079 & T19-095)
- TS00045** 4.5mm Cortical Tap (Fits E17-079 & T19-095)
- TS00045L** 4.5mm Extra Long Tap (195mm Long) 100mm Thread (Fits E17-079 & T19-095)

Modular Locking Taps



- TSLS20-A** Tap for 2.0mm Locking Screws (Fits D17-080)
- TSLS24** Tap for 2.4mm Locking Screws (Fits E17-079 & T19-095)
- TSLS27** Tap for 2.7mm Locking Screws (Fits E17-079 & T19-095)
- TSLS35** Tap for 3.5mm Locking Screws (Fits E17-079 & T19-095)
- TSLSET-A** Locking Screw Tap Set. 4 Taps and 2 handles

5.5mm Tap - Quick Release Square Fit



TQH55 Handle for 5.5mm Cortical Tap - Square Fit
TQ00055 5.5mm Cortical Tap - Square Fit

T Bar Cortical Taps - Fixed Handle



TBT015 T Bar Tap 1.5mm Cortical
TBT020 T Bar Tap 2.0mm Cortical
TBT027 T Bar Tap 2.7mm Cortical
TBT12535 T Bar Tap 3.5mm Cortical
TBT17535 T Bar Tap 3.5mm Small Cancellous

Countersinks

Modular Countersinks



E17-079 Soft Touch Quick Release Handle - AO Fit



D17-080 Soft Touch Quick Release Handle - Dental Fit



T19-095 Soft Touch T-Bar Handle Quick Release - AO Fit

Countersinks - Quick Release



If the screw is destined to screw down onto the surface of the bone without a plate, it is helpful to contour the top of the screw hole to fit the screw head. This procedure is especially important when lag screwing relatively small fragments. Failure to countersink may lead to fracture of the bone fragment.

COU1520QRD Quick Release Countersink For 1.5/2.0mm Screws (Fits D17-080)

COU2427QR Quick Release Countersink For 2.4/2.7mm Screws (Fits E17-079 & T19-095)

COU3540QR Quick Release Countersink For 3.5/4.0mm Screws (Fits E17-079 & T19-095)

COU4565QR Quick Release Countersink For 4.5/6.5mm Screws (Fits E17-079 & T19-095)

Countersinks - Fixed Handle



COU1520T-A T Bar Countersink for 1.5/2.0mm Screws

COU2427T-A T Bar Countersink for 2.4/2.7mm Screws

COU3540T-A T Bar Countersink for 3.5/4.0mm Screws

COU4565T-A T Bar Countersink for 4.5 - 6.5mm Screws



Loan Kits

For a nominal fee, we have a range of **specialist loan kits** available to complement your own fleet. With next working day availability, the service offers flexibility as procedures are booked with your clients.

To find out more, scan the QR code below.



Drill Bits

Drill Bits - Round Shank

Round shank multi-use drill bits made from hardened stainless steel, suitable for use with a standard Jacobs chuck.



Standard Length

Suitable for most applications.

	Diameter (mm)	Total Length (mm)	Flute Length (mm)
H090100	1.1	70	20
H090101	1.5	90	20
H090208	1.8	110	25
H090202	1.9	110	25
H090102	2.0	110	30
H090203	2.3	120	30
H090209	2.4	120	30
H090112	2.5	120	30
H090104	2.7	130	40
H090103	2.8	130	40
H090205	3.0	130	40
H090105S	3.2	130	40
H090106S	3.5	130	50
H090207	3.8	130	50
H090107S	4.0	130	50
H090108S	4.5	130	50
H090109S	5.5	130	60

Long Length

	Diameter (mm)	Total Length (mm)	Flute Length (mm)
H090101L	1.5	120	20
H090208L	1.8	140	25
H090102L	2.0	140	30
H090209L	2.4	150	30
H090112L	2.5	150	30
H090104L	2.7	170	40
H090103L	2.8	170	40
H090105L	3.2	180	40
H090106L	3.5	180	50
H090107/L	4.0	180	50
H090108L	4.5	180	50
H090109/L	5.5	180	60

Please note that longer drill bits are more prone to snapping and it is more difficult to control the hole angle and accuracy – therefore standard length drill bits should be used where possible. Where a longer drill bit is required it should be used with particular care and attention; use of a long drill guide may help to minimise problems.

Drill Bits - Quick Release AO Fit

Quick release multi-use drill bits made from hardened stainless steel, suitable for use with an AO style quick release chuck.



Standard Length

Suitable for most applications.

	Diameter (mm)	Total Length (mm)	Flute Length (mm)
S090100S	1.1	80	20
S090101S	1.5	100	20
S090208	1.8	110	25
S090102S	2.0	110	30
S090209	2.4	120	30
S090112S	2.5	130	30
S090104S	2.7	130	40
S090103S	2.8	140	40
S090105S	3.2	140	40
S090106S	3.5	140	50
S090107	4.0	170	50
S090108S	4.5	140	50
S090109	5.5	170	50

Long Length

	Diameter (mm)	Total Length (mm)	Flute Length (mm)
S090100L	1.1	110	20
S090101L	1.5	130	20
S090208L	1.8	140	25
S090102L	2.0	140	30
S090209L	2.4	170	30
S090112L	2.5	180	30
S090104L	2.7	180	40
S090103L	2.8	190	40
S090105L	3.2	190	40
S090106L	3.5	190	50
S090108L	4.5	190	50

Mini Quick Release Drill Bits - Dental Fit

These smaller drill bits are too delicate for use with a power drill, and are designed for use with the D17-080 dental fit handle. This improves control and helps prevent breakages.

- 10MDB07-A 0.7mm Drill Bit Dental Fit 60mm
- 10MDB10-A 1.0mm Drill Bit Dental Fit 60mm

Drill Bits - Anti-Skid - Round Shank



Anti-skid drill bits have a special tip which bites into the bone surface, accurately positioning the hole. Particularly useful for holes which are not perpendicular to the bone surface, and where a drill guide is not used.

Round shank multi-use drill bits made from hardened stainless steel, suitable for use with a standard Jacobs chuck.

	Diameter (mm)	Total Length (mm)	Flute Length (mm)
H090101AS	1.5	90	20
H090208AS	1.8	110	25
H090102AS	2	110	30
H090209AS	2.4	120	30
H090112AS	2.5	120	30
H090104AS	2.7	130	40
H090105SAS	3.2	130	40
H090106SAS	3.5	130	50
H090108SAS	4.5	130	50

Drill Bits - Cannulated - Round Shank & AO Fit



For use with a 1.1mm guide wire for accurate placement of holes.

Round Shank

Round shank multi-use cannulated drill bits made from hardened stainless steel, suitable for use with a standard Jacobs chuck.

	Diameter (mm)	Total Length (mm)	Flute Length (mm)
H090112CAN	2.5	130	25
H090104CAN	2.7	130	30
H090106CAN	3.5	130	35

Quick Release AO Fit

Quick release multi-use cannulated drill bits made from hardened stainless steel, suitable for use with an AO style quick release chuck.



	Diameter (mm)	Total Length (mm)	Flute Length (mm)
S090112CAN	2.5	105	25
S090104CAN	2.7	105	30
S090106CAN	3.5	105	35

Pre-Drilling ESF Pin Tracts



Pre-drilling a pin tract hole in the bone into which the ESF pin is subsequently inserted is very important as the ESF pins do not have drilling ends. Otherwise insertion of an ESF pin directly into the bone may cause impaction, micro-fracturing of the bone and excessive heat production with bone necrosis, all of which can lead to pin loosening. A drill bit that is about 10% smaller than the shank (core) diameter of the pin, or at least 0.1mm smaller, should be used. A slow speed (electric) drill at about 150rpm is advisable, using flush to cool the pin and minimise heat generated in the bone that could cause bone necrosis and pin loosening. An appropriate drill guide is used to protect the soft tissues and minimise drill wobble and skidding. Once the hole is drilled, a K-wire can be used to maintain the pin tract (before the drill guide is removed) so it can be easily re-identified once the ESF pin is ready to be inserted.

- H090202** 1.9mm Pre-Drill For 2.0mm Shank Positive Pin
- H090203** 2.3mm Pre-Drill For 2.4mm Shank Positive Pin
- H090205** 3.0mm Pre-Drill For 3.2mm Shank Positive Pin
- H090207** 3.8mm Pre-Drill For 4.0mm Shank Positive Pin
- H090101** 1.5mm Pre-Drill For 2.0mm Shank Negative Pin
- H090102** 2.0mm Pre-Drill For 2.4mm Shank Negative Pin
- H090104** 2.7mm Pre-Drill For 3.2mm Shank Negative Pin
- H090106L** 3.5mm Pre-Drill For 4.0mm Shank Negative Pin

Drill Stops



Drilling to a pre-measured depth can be a challenge. A drill stop is tightened onto the drill bit at the required depth. The Set includes 4 Stops to cover all the standard drill sizes. 1.5mm, 2.0mm, 2.5mm, 2.7mm, 3.2mm, 3.5mm and 4.5mm. The stop is tightened onto the drill bit using the hex driver provided.

DRILLSTOP Drill Stop Set in Stainless Case

Wires & Pins

Wires are simple, but versatile implants. Our specially selected stainless steel wires are both very hard and very stiff improving their driving characteristics and performance in situ.

Cutting with sufficiently robust implant cutters with hard jaws is obligatory.

These wires will damage cutters with stainless steel edges, e.g. combined wire twistors/shear cutters.

Arthrodesis Wire 125mm Long

Rather like small Intra-medullary Pins, Arthrodesis Wires have trochar points at each end.

They are used for the fixation of small bone fragments, produced either electively or as a result of trauma, e.g. distal femoral fractures, tibial crest transplants and femoral neck fractures. 125mm Long. Supplied in packs of ten.

090054ART	0.8mm Arthrodesis Wire 125mm Pack of 10
090020ART	0.9mm Arthrodesis Wire 125mm Pack of 10
090060ART	1.0mm Arthrodesis Wire 125mm Pack of 10
090021ART	1.1mm Arthrodesis Wire 125mm Pack of 10
090061ART	1.25mm Arthrodesis Wire 125mm Pack of 10
090024ART	1.4mm Arthrodesis Wire 125mm Pack of 10
090062ART	1.5mm Arthrodesis Wire 125mm Pack of 10
090022ART	1.6mm Arthrodesis Wire 125mm Pack of 10
090026ART	1.8mm Arthrodesis Wire 125mm Pack of 10
090023ART	2.0mm Arthrodesis Wire 125mm Pack of 10
090025ART	Pack of Mixed Arthrodesis Wires

Arthrodesis Wire 178mm Long (Extra Long)

090064ART	0.9mm Arthrodesis Wire 178mm Pack of 10
090065ART	1.1mm Arthrodesis Wire 178mm Pack of 10
090066ART	1.4mm Arthrodesis Wire 178mm Pack of 10
090067ART	1.6mm Arthrodesis Wire 178mm Pack of 10
090068ART	1.8mm Arthrodesis Wire 178mm Pack of 10
090069ART	2.0mm Arthrodesis Wire 178mm Pack of 10

Arthrodesis Wire Extra Fine 70mm Long

Arthrodesis Wires - Extra Fine. 70mm long with one trochar end and one blunt end. Useful for exotics. Supplied in packs of ten.

090056ART	0.6mm Arthrodesis Wire Trochar/B 70mm Pack of 10
090055ART	0.7mm Arthrodesis Wire Trochar/B 70mm Pack of 10

Kirschner Wire 125mm Long

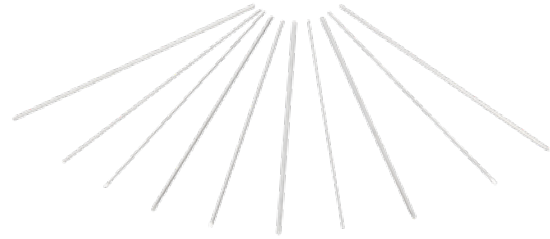

One tip bayonet, the other blunt, these Pins are supplied in packs of ten. 125mm Long.

090030KIR	0.9mm Kirschner Wire 125mm Pack of 10
090070KIR	1mm Kirschner Wire 125mm Pack of 10
090031KIR	1.1mm Kirschner Wire 125mm Pack of 10
090071KIR	1.25mm Kirschner Wire 125mm Pack of 10
090034KIR	1.4mm Kirschner Wire 125mm Pack of 10
090072KIR	1.5mm Kirschner Wire 125mm Pack of 10
090032KIR	1.6mm Kirschner Wire 125mm Pack of 10
090073KIR	1.8mm Kirschner Wire 125mm Pack of 10
090033KIR	2.0mm Kirschner Wire 125mm Pack of 10
090030MIX	Pack of Mixed Kirschner Wires

Kirschner Wire 178mm Long (Extra Long)

One tip bayonet, the other blunt, these Pins are supplied in packs of ten. 178-180mm Long. Extra long.

090074KIR	0.9mm Kirschner Wire 180mm Pack of 10
090075KIR	1.1mm Kirschner Wire 178mm Pack of 10
090076KIR	1.4mm Kirschner Wire 178mm Pack of 10
090077KIR	1.6mm Kirschner Wire 178mm Pack of 10
090078KIR	1.8mm Kirschner Wire 178mm Pack of 10
090079KIR	2mm Kirschner Wire 178mm Pack of 10

Threaded Pins & Wires

Threaded wires have a much greater pull out resistance than smooth wires. They are very easy to insert using standard drills fitted with Jacobs chucks or wire drivers. Although having only trochar tips they will self tap in all but the hardest of cortical bone. Driven across fragments, threaded wires act as mini position screws which can be cut off flush to the bone surface or buried. It may be possible to place several threaded wires at angles to each other in a relatively small area.

Available in coarse or fine thread pitches. Use the coarse in cancellous or metaphyseal bone.

Coarse Threaded Small Fragment Pins



Use threaded pins where you might use a 2mm fixation screw or K Wire, e.g. tibial crest transplant. Drive in with slow speed drill. Relatively coarse threads. 0.8mm thread pitch.

090036	Threaded Pins 5mm Thread Single
090037	Threaded Pins 10mm Thread Single
090027	Threaded Pins 15mm Thread Single
090028	Threaded Pins 20mm Thread Single

1.6mm Threaded Pins with Olive

KS1101	1.6mm Threaded Pin with Olive
KS1102	1.6mm Threaded Pin with Olive

Fine Threaded Small Fragment Pins 2.0mm

Use singly to re-attach small bone fragments. Use in multiples to re-attach larger fragments e.g. humeral condyles. (4 x 2.0 threaded pins have similar properties to one 3.5 screw while interfering less with the healing process). Use threaded washer to create screw effect. Very easy to insert using an orthopaedic drill.

Thread pitch is 0.4mm for use in cortical bone. Self drilling. Cut off excess pin. For maximum pull out resistance drill through trans cortex and cut off trochar cutting tip.

090310	Fine Threaded Pin 10mm Thread Length	Single
090315	Fine Threaded Pin 15mm Thread Length	Single

Steinman Intra-Medullary Pins

Simple, cheap and often the best technique for the repair of long bones. I/M pinning does not resist compression and rotation very effectively. It may be helpful to add an external fixator for two weeks if in any doubt. Smooth pins are most likely to migrate. The threaded pins are negatively cut and do reduce backing out particularly if the distal fragment is small.

Our trochar tips are designed to cut bone but care must be exercised to avoid heat necrosis during insertion. Can be cut in half to produce cheap ESF pins.

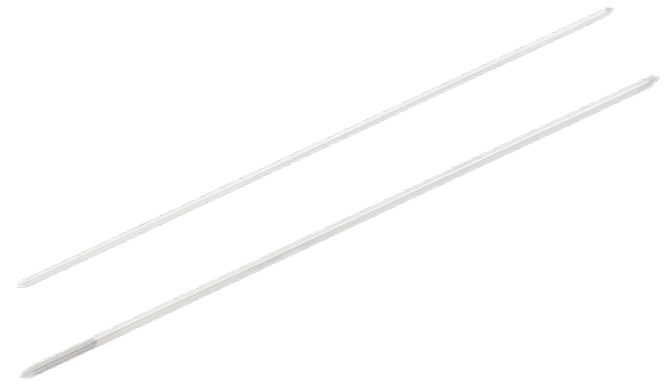

090000	1.6mm Bone Pin Trochar 300mm	1/16"
090001	2.0mm Bone Pin Trochar 300mm	5/64"
090002	2.4mm Bone Pin Trochar 300mm	3/32"
090003	2.8mm Bone Pin Trochar 300mm	7/64"
090004	3.2mm Bone Pin Trochar 300mm	1/8"
090005	3.5mm Bone Pin Trochar 300mm	9/64"
090006	4.0mm Bone Pin Trochar 300mm	5/32"
090007	4.8mm Bone Pin Trochar 300mm	3/16"
090153	6mm Bone Pin Trochar 300mm	1/4"
090008	6.35mm Bone Pin Trochar 300mm	1/4"
090010	1.6mm Bone Pin Screw End 300mm	1/16"
090011	2.0mm Bone Pin Screw End 300mm	5/64"
090012	2.4mm Bone Pin Screw End 300mm	3/32"
090013	2.8mm Bone Pin Screw End 300mm	7/64"
090014	3.2mm Bone Pin Screw End 300mm	1/8"
090015	3.5mm Bone Pin Screw End 300mm	9/64"
090016	4.0mm Bone Pin Screw End 300mm	5/32"
090017	4.8mm Bone Pin Screw End 300mm	3/16"
090154	6.0mm Bone Pin Screw End 300mm	1/4"
090018	6.35mm Bone Pin Screw End 300mm	1/4"

Fully Threaded Arthrodesis Wires



090093ART	Fully Threaded Wire Single 1.5mm
090094ART	Fully Threaded Wire Single 2.0mm

Wire & Pin Storage Arthrodesis Wire Box



Box will store all diameters of Arthrodesis and K Wires in four compartments.

0900200 Arthrodesis & K Wire Organiser Plastic (Autoclavable)

Bone Pin Roll



Bone pin storage and sterilisation is difficult. Pins are long and sharp. The bone pin roll stores at least one of each pin.

An added advantage is that the pins do not penetrate sterilisation bags.

090038 Bone Pin Roll

A & K Wire Holders for 5"/125mm Wires



The simplest solution for storing A/ K wires is to have a tube dedicated for each size marked clearly with the diameter. There is no possibility for confusion. Each tube is 165mm long and 12mm diameter and will take any wire less than 150mm in length.

0900390.8 0.8mm A & K Wire Holder
0900390.9 0.9mm A & K Wire Holder
0900391.0 1.0mm A & K Wire Holder
0900391.1 1.1mm A & K Wire Holder
0900391.2 1.25mm A & K Wire Holder
0900391.4 1.4mm A & K Wire Holder
0900391.5 1.5mm A & K Wire Holder
0900391.6 1.6mm A & K Wire Holder
0900391.8 1.8mm A & K Wire Holder
0900392.0 2.0mm A & K Wire Holder
090039SET A & K Wire Holder Set (10)

Bone Pin Tubes



090039C Pin Storage Autoclave Tube 225mm

IM Pin Box



Keep all your 300mm IM Pins arranged and in size order safely within our IM pin box. The hard box will reduce the chance of personal injury and the risks of perforating packaging.

The box is fully autoclavable, but also makes an excellent stock-box. At a glance you can quickly see how many of each size pin it is holding. The box features a platform with a clearly marked metric and imperial pin gauge to make it very user friendly.

The pin sizes are, 1.6mm, 2.0mm, 2.4mm, 2.8mm, 3.2mm, 3.6mm, 4.0mm, 4.8mm and 6.35mm. Box external dimensions 308 x 138 x 64mm.

IMPBOX01 IM Pin Box With Insert - Supplied Empty
IMPBOXTRO IM Pin Box Complete With Steinman Pins Trochar Tips
IMPBOXSCR IM Pin Box Complete With Steinman Pins Screw Point Tips

A & K Wire Dispenser



The tube is sub-divided into four sections each of which has a window through which the wires may be viewed. The knurled dispensing tip is rotated until the hole is over the desired wire size and the wire shaken out. Total length 175mm. For wires 125mm. Marked with the standard sizes of 0.9mm, 1.1mm, 1.6mm and 2.0mm.

090039E A & K Wire Dispenser 0.9mm, 1.1mm, 1.6mm & 2.0mm

Orthopaedic Wire



Cerclage wire is an extremely useful method of fragment fixation. Use as thick a wire as seems possible. Twist evenly under tension. The best instrument is our Wire Twister/Cutter 001260. Minimise wire movement on periosteum. Tension wire banding should be performed when muscular forces must be transferred beyond a fracture or osteotomy, e.g. Tibial crest avulsion or trochanteric osteotomy. 1.0mm Wire is the most useful for mid-sized dogs. All are supplied in 10 metre rolls.

- OW0210** 32g Reel of Orthopaedic Wire 0.20mm
- OW0310** 30g Reel of Orthopaedic Wire 0.30mm
- OW0410** 27g Reel of Orthopaedic Wire 0.40mm
- OW0510** 25g Reel of Orthopaedic Wire 0.5mm
- OW0610** 24g Reel of Orthopaedic Wire 0.6mm
- OW0710** 22g Reel of Orthopaedic Wire 0.71mm
- OW0810** 21g Reel of Orthopaedic Wire 0.8mm
- OW0910** 20.5g Reel of Orthopaedic Wire 0.9mm
- OW1010** 20g Reel of Orthopaedic Wire 1.0mm
- OW1012** 18g Reel of Orthopaedic Wire 1.2mm
- OW1015** 16g Reel of Orthopaedic Wire 1.5mm



For convenience and identification rolls of orthopaedic wire can be marked with padlock security tags. This also has the added advantage of stopping rolls of wire unravelling in the operating theatre.

Orthopaedic Wire Kit



Cerclage wire can be a very useful means of fragment fixation. Kit containing our most popular cerclage instruments and a roll of wire, discounted over component price.

Kit contains:

- | | | |
|--------|------------------------------------|----|
| 001260 | Wire Twister | x1 |
| 001256 | Set of 3 Single Ended Wire Passers | x1 |
| OW1010 | 10m Roll of 1.0mm Orthopaedic Wire | x1 |

OWKIT Orthopaedic Wire Kit

Wire Passers can be found on page 25.

Wire Twister/Shear Cutter



- Jaws lock onto wire to enable easy twisting under tension for kink-free cerclage. The wire must be twisted under tension to create an even spiral
- Improved design, long life shear action cutter will cut 18 gauge (1.2mm) wire twisted double
- Serrated jaws grip and turn cut ends. Jaws have fenestration for extra grip
- Not designed to cut A + K wires, pins or fish hooks
- Available with Tungsten Carbide Jaws for extra grip (not fenestrated)

- 001260** Wire Twister/Shear Cutter 165mm Long
- 001261** Wire Twister/Shear Cutter - Tungsten Carbide Jaws 165mm Long

Wires With Eyelet

The free end of the wire is threaded through the eye. The cerclage is tightened using the special tightener. Requires a device for tightening eyed wires, see 001262 and 001264

- CWWE22** Orthopaedic Wire With Eyelet 22g x 12" (6 Pack)
- CWWE20** Orthopaedic Wire With Eyelet 20g x 12" (6 Pack)
- CWWE18** Orthopaedic Wire With Eyelet 18g x 12" (6 Pack)

Wire Tightener For Eyed Wires



Used to tension eyed wires very tightly. The cerclage is finished by kinking the wire back against the eye.

- 001262** Wire Loop Tightener 125mm Long

Wire Tightener With Two Cranks For Double Loop Cerclage & Eyed Wire



Use with single crank for eyelet wires. Use both cranks to tighten double loops.

- 001264** Wire Tightener With Two Cranks 240mm Long

Drill Guides & Sleeves

Universal Drill Guides

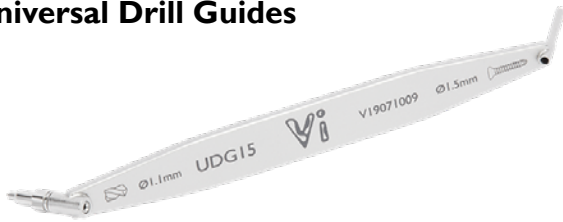

UDG15 – Universal Drill Guide for 1.5mm screws:

For load and neutral positioning of 1.1mm drills and tissue protector for 1.5mm tap

UDG20 – Universal Drill Guide for 2.0mm screws:

For load and neutral positioning of 1.5mm drills and tissue protector for 2.0mm tap

UDG24 – Universal Drill Guide for 2.4mm screws:

For load and neutral positioning of 1.8mm drills and tissue protector for 2.4mm tap

UDG27 – Universal Drill Guide for 2.7mm screws:

For load and neutral positioning of 2.0mm drills and tissue protector for 2.7mm tap

UDG35 – Universal Drill Guide for 3.5mm screws:

For load and neutral positioning of 2.5mm drills and tissue protector for 3.5mm tap

- UDG15** Universal Drill Guide For 1.5mm Screws
- UDG20** Universal Drill Guide For 2.0mm Screws
- UDG24** Universal Drill Guide For 2.4mm Screws
- UDG27** Universal Drill Guide For 2.7mm Screws
- UDG35** Universal Drill Guide For 3.5mm Screws

Locking Screw Drill Guides



- LSDG15** Locking Screw Drill Guide For 1.5mm
- LSDG20** Locking Screw Drill Guide For 2.0mm
- LSDG2424** Locking Screw Drill Guide For 2.4mm
- LSDG2724** Locking Screw Drill Guide For 2.7mm
- LSDG35** Locking Screw Drill Guide For 3.5mm
- LSDG20XL** Locking Screw Drill Guide For 2.0mm Extra Long
- LSDG2424XL** Locking Screw Drill Guide For 2.4mm Extra Long
- LSDG2724XL** Locking Screw Drill Guide For 2.7mm Extra Long
- LSDG35XL** Locking Screw Drill Guide For 3.5mm Extra Long
- LSDG35XXL** Locking Screw Drill Guide For 3.5mm Double XL

Locking Wire Guide



Screws into the locking plate to allow placement of a K Wire for temporary fixation of the plate to the bone. May also be used to facilitate plate manipulation during MIPO application.

- L20W11G** Locking 2.0mm Wire 1.1mm Guide
- L24W14G** Locking 2.4mm Wire 1.4mm Guide
- L27W16G** Locking 2.7mm Wire 1.6mm Guide
- L35W20G** Locking 3.5mm Wire 2.0mm Guide

Load Neutral Drill Guides



To exert compression at the fracture site, the cortical screw must be positioned precisely within the slot in the compression plate. The Load Neutral Drill Guide has two tips, one for compression (load) and one where no compression is exerted (neutral). There is one combination for each screw/plate size. Each guide is marked with the drill size to be used.

- LNDG15** Load Neutral Drill Guide For 1.5mm Compression Plates
- LNDG20** Load Neutral Drill Guide For 2.0mm Compression Plates
- LNDG24** Load Neutral Drill Guide For 2.4mm Compression Plates
- LNDG27** Load Neutral Drill Guide For 2.7mm Compression Plates
- LNDG35** Load Neutral Drill Guide For 3.5mm Compression Plates
- LNDG45** Load Neutral Drill Guide For 4.5mm Compression Plates

Insert Sleeves



Insert Sleeves centre smaller drills in the placement of lag screws.

- SL2015** Insert Sleeve 2.0mm o/d 1.5mm i/d
- SL2418** Insert Sleeve 2.4mm o/d 1.8mm i/d
- SL2720** Insert Sleeve 2.7mm o/d 2.0mm i/d
- SL3520** Insert Sleeve 3.5mm o/d 2.0mm i/d
- SL3525** Insert Sleeve 3.5mm o/d 2.5mm i/d
- SL3527** Insert Sleeve 3.5mm o/d 2.7mm i/d
- SL4532** Insert Sleeve 4.5mm o/d 3.2mm i/d
- SL5540** Insert Sleeve 5.5mm o/d 4.0mm i/d
- SL6545** Insert Sleeve 6.5mm o/d 4.5mm i/d

Tissue Protection Sleeves



Rotating pins, drills and taps will "pick up" soft tissues, skin, muscle, nerve and blood vessels, causing serious damage. Use of tissue protection sleeves minimises such damage. The teeth at the top of the guide locate on the bone whilst the stainless tube provides a barrier between soft tissue and implant equipment.

- TP2020** For Drill/Taps To 2.0mm 90mm
- TP0024** For Drill/Taps To 2.4mm 90mm
- TP0027** For Drill/Taps To 2.7mm 90mm
- TP0035** For Drill/Taps To 3.5mm 90mm
- TP0045** For Drill/Taps To 4.5mm 90mm

Drill Guide 0.7/1.0mm



Due to the size limitations, this device serves only as a drill guide and cannot be used as an insert sleeve or tap guide.

CDTIS10 Drill Guide 0.7mm/1.0mm

Adjustable Drill Guide



Our Adjustable Drill Guide allows accurate placement of drill holes by predetermination of drill entry and exit points. Locks onto bone to minimise errors.

- The swivelling point allows use of the guide where access is limited
- Supplied with 2.0, 2.5 and 3.5 Drill Sleeves. Use the appropriate sleeve for the drill in use
- A scale on the instrument measures hole depth
- Applications include condyle fractures, femoral neck tunnels, screw holes, and ununited anconeal process

In our view this design has significant advantages over CEG and C guides

ADJDG2035 Adjustable Drill Guide For 2.0mm/2.5mm/3.5mm Drills 175mm

KWG10 K-wire Guide For ADJDG2035

ADJDG45 Adjustable Drill Guide 4.5mm Drills 190mm

C Drill Guide



Use of an appropriately sized drill guide enables the surgeon to control exactly the entry and exit points of drills. This ability is extremely important in lag screwing.

Various insert sleeves are available for each drill size, with an accurate guidance system, and provide exact positioning of holes for lag screwing. (e.g. for a 3.5mm cortical screw, drill 3.5 lag hole in proximal cortex, insert SL3525 and drill through it into the trans cortex. Finally tap and insert screw).

CEG2735 Small Drill Guide i/d 3.5mm 'C' Guide 135mm

Triple Drill Guides



Triple Drill Guides are used to accurately position drills and K or arthrodesis wires. The three holes in the head allow for the placement of parallel anti-rotation wires.

SLG1115 Double Drill Guide/Sleeve For 1.1mm & 1.5mm Drills 100mm

SLG0020 Triple Drill Guide/Sleeve For 2.0mm Drills 115mm

SLG0025 Triple Drill Guide/Sleeve For 2.5mm Drills 115mm

Combination Drill, Tap & Insert Sleeve



The large end has an internal diameter which matches the clearance drill and tap. The small end has an internal diameter the same as the pilot drill and an external diameter which fits the clearance drill hole, i.e. the same as an insert sleeve. This single instrument contains all the guides and sleeves you need to place a lag screw.

CDTIS20 Combination Drill, Tap & Insert Sleeve for 2.0 Screws 100mm

CDTIS24 Combination Drill, Tap & Insert Sleeve for 2.4 Screws 105mm

CDTIS27 Combination Drill, Tap & Insert Sleeve for 2.7 Screws 110mm

CDTIS35 Combination Drill, Tap & Insert Sleeve for 3.5 Screws 115mm

CDTIS45 Combination Drill, Tap & Insert Sleeve for 4.5 Screws 130mm

Depth Gauges



Accurate measurement of hole depth is essential in order to select the appropriate screw size.

A range of gauges are available for various screw sizes. Hole depth is read from the instrument. Add extra to the measured length to ensure maximal screw thread/bone interface engagement.

Chart supplied with depth gauge or available on request. Use in self-tapping or cortical systems.

- DG2027** Depth Gauge For 2.0mm & 2.7mm Screws 135mm
- DG242735** Depth Gauge For 2.4mm, 2.7mm & 3.5mm Screws 180mm (TTA only)
- DG2735** Depth Gauge For 2.7mm & 3.5mm Screws 175mm
- DG4565** Depth Gauge For 4.5mm & 6.5mm Screws 290mm

Premium Depth Gauge



Radius matches screw under-head to replicate screw position. Improved hook. Contoured comfortable grip for ease of use. Store in fully retracted state to protect the delicate probe section.

- DGP15** Premium Depth Gauge For 1.5mm Screws
- DGP2024** Premium Depth Gauge For 2.0/2.4mm Screws
- DGP2735** Premium Depth Gauge For 2.7/3.5mm Screws

Bone Plate Contouring Bone Plate Bending Levers



Bone plates appropriate for the repair of load bearing long bones are very stiff. Accurate contouring of plates is essential for precise fracture reduction; however, marking of plates during the bending process will lead to reduced fatigue strength.

Contoured plates should be placed with adequate support to minimise cyclical loading.

Extra length benders 01288L are particularly useful for contouring larger TPLO plates along with 3.5mm and 4.5mm standard plates.

Bone plate benders used in pairs are the most economic method of plate contouring. Supplied in pairs.

- 001280** 1.0mm Bending Levers 130mm Long
- 001286** AO Type 1.5mm/2.0mm Bending Levers 130mm Long
- 001285** AO Type 2.4mm Bending Levers 140mm Long
- 001287** AO Type 2.7mm/3.5mm Bending Levers 175mm Long
- 001288** AO Type 3.5mm/4.5mm Broad Bending Levers 200mm Long
- 001288L** 3.5/4.5 Extra Long Bending Levers 240mm Long

Delta TPLO Plate Benders With Curved Slots



Plate benders with slots tend to distort the Delta plate.

The curved slots help grip and support the plate during the bending process. In addition the plate is much less likely to end up on the floor.

- TPLODELBEND** Delta TPLO Plate Benders (Pair) 230mm Long

Plate Bending Pliers - Roller Type



- 001283SMALL** Plate Bending Pliers Roller Type 230mm Long Suitable For 3.5mm Plates
- 001283** Plate Bending Pliers Roller Type 380mm Long Suitable For 3.5mm & 4.5mm Plates

Bone Plate Press



- 001281** Bone Plate Press Small 285mm Long For Plates Up To & Including 4.5mm Narrow
- 001282** Bone Plate Press Large 410mm Long For All Plates

Tips on the use of the Plate Press

- The press works at maximum efficiency when the handle is approx. parallel with the base. Make sure the press is on a stable firm surface
- Place the plate to be contoured in between the anvils
- Adjust the gap between the anvils using the screw until the handle is parallel with the base
- Pressure on the handle will bend the plate
- Readjust the press using the screw to bring the handle parallel once again
- Contouring the plate should be accomplished using several small adjustments rather than one big one

Please check the press selected will fit your autoclave before purchase.

AO Type Plate Bending Pliers



These pliers will contour 2.7mm and 3.5mm narrow plates. 3.5mm DCP's will require multiple small bends. Also useful for bending guide pins in the Slocum TPLO technique.

- 001289B** AO Plate Bending Pliers 2.7mm/3.5mm

Heavy Duty Bone Plate Pliers To 4.5mm



The largest bone plate pliers in the range, these will contour all plates other than the 4.5mm broad.

The bending head has 3 interchangeable anvils and the 'hammer' side has 3 different shapes which rotate. This offers the surgeon 6 different contouring options to match different plates and different shapes.

- 001289C** Heavy Duty Plate Bending Pliers
- 001289SA** Small Anvil For 2.7mm Plates (For Existing Users)

Bending Templates

To avoid repeated entry into the operation site when contouring plates, an aluminium bending template is contoured to the bone. The steel plate is then bent to match the template using irons or a bone plate press.

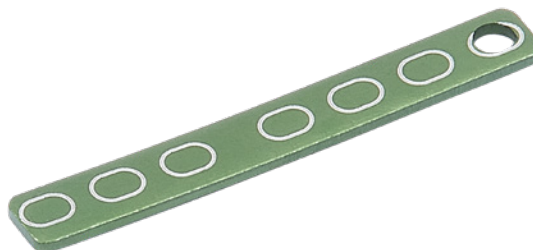

- BT200737** Bending Template 37mm For 2.0mm DCPs & Round Hole Plates
- BT240752** Bending Template 52mm For 2.4mm DCPs & Round Hole Plates
- BT270760** Bending Template 60mm For 2.7mm DCPs & Round Hole Plates
- BT350786** Bending Template 86mm For 3.5mm DCPs & Round Hole Plates
- BT4507120** Bending Template 120mm For 4.5mm DCPs & Broad 3.5mm DCPs & HD & Round Hole Plates
- BT152700** Bending Template For 2.0mm Supracondylar Plate
- BT152711** Bending Template For 2.4mm Supracondylar Plate
- BT152714** Bending Template For 2.7mm Supracondylar Plate
- BT152717** Bending Template For 3.5mm Supracondylar Plate

Screw Holding Forceps



A useful instrument for selecting screws with minimal handling. Can be used with any style of screw.

- SF1024** Screw Holding Forceps 1.0/1.5/2.0/2.4mm Screws
SF2055 Screw Holding Forceps 2.4/2.7/3.5/4.5mm Screws

Plate Holding Clip



A useful little clip for holding plates in sequence. Labelled with size.

- BPC2** Plate Holding Clip 2.0mm
BPC24 Plate Holding Clip 2.4mm
BPC27 Plate Holding Clip 2.7mm
BPC35 Plate Holding Clip 3.5mm

Cerclage Button



- CB15** Cerclage Button For 1.5 DCP
CB20 Cerclage Button For 2 DCP
CB24 Cerclage Button For 2.4 DCP
CB27 Cerclage Button For 2.7 DCP
CB35 Cerclage Button For 3.5 DCP

Webb Bolts



Use where a lag screw strips out. Supplied as a threaded rod, two nuts and two washers.
 Pre-measure and cut to length or crop after procedure. Saw cut or bolt cutting will prevent loosening of the nut on the cut side.
 Run a fine nylon suture through the nut prior to attachment to create a locking effect.

5mm Webb Bolt use 5.5mm Drill H090109S. Requires 8mm spanner (001565).

4mm Webb Bolt use 4.0mm Drill H090107S. Requires 7mm spanner (001566).

3mm Webb Bolt use 3.2mm Drill H090105S. Requires 5.5mm spanner.

2mm Webb Bolt use 2.0mm Drill H090102. Requires 4mm spanner.

- 092003** Webb Bolt 5mm/8cm
092000 Webb Bolt 4mm/8cm
092001 Webb Bolt 3mm/8cm
092002 Webb Bolt 2mm/5cm

Washers



Use to spread load or retain wire or sutures. Use with cortical or self tapping screws. Spikey washers are used to reattach ligaments.

- PW15** Plain Washer 1.5mm Screws Stainless
PW20 Plain Washer 2.0mm/1.5mm Screws Stainless
PW20B Plain Washer 2.0mm Screws Broad 6mm Diameter
PW24 Plain Washer 2.4mm Screws Stainless
PW24TI Plain Washer 2.4mm Screws Titanium
PW273540 Plain Washer 2.7mm/3.5/4.0mm Screws Stainless 7.0mm Dia
PW273540B Plain Washer 2.7mm/3.5mm/4.0mm Screws Stainless 8.5mm Dia
PW45 Plain Washer 4.5mm Screws Stainless
SW15 Spikey Washer 1.5mm Screws Stainless
SW20 Spikey Washer 2.0mm Screws Stainless
SW27 Spikey Washer 2.7mm Screws Stainless
SW3540 Spikey Washer 3.5mm/4.0mm Screws Stainless
SW45 Spikey Washer 4.5mm Screws Stainless

Cortical Nuts



Occasionally tapped threads strip and a larger screw is appropriate. Lag screws are particularly vulnerable as only one cortex is available.

A cortical nut manufactured from implant grade nylon gives the screw purchase allowing normal tightening. The thread form is designed to grip the screw to minimise 'backing out'.

Available in 2.0mm, 2.4mm, 2.7mm, 3.5mm and 4.5mm cortical thread forms. Supplied as a single sterile pack. The cortical nuts are also available in stainless steel.

- N20** 2.0mm Cortical Nut Stainless Steel (Non Sterile)
- N24** 2.4mm Cortical Nut Stainless Steel (Non Sterile)
- N27** 2.7mm Cortical Nut Stainless Steel (Non Sterile)
- N35** 3.5mm Cortical Nut Stainless Steel (Non Sterile)
- N45** 4.5mm Cortical Nut Stainless Steel (Non Sterile)
- CN20-A** 2.0mm Cortical Nut Nylon (Sterile)
- CN24-A** 2.4mm Cortical Nut Nylon (Sterile)
- CN27-A** 2.7mm Cortical Nut Nylon (Sterile)
- CN35-A** 3.5mm Cortical Nut Nylon (Sterile)
- CN45-A** 4.5mm Cortical Nut Nylon (Sterile)

Cortical Nut	Nut Profile	Associated Spanner Size
N20	Square	3.5mm
N24	Square	4.5mm
N27	Hex	1/4"
N35	Hex	7mm
N45	Hex	1 1/42"

Screw Extraction Trepine



Once the head of a screw has become detached the shaft can be very difficult to extract, particularly when the screw has been in situ for some time. The screw extraction trephine is designed to 'core out' the screw shaft either in its entirety or partially to allow the screw to be grasped by extraction forceps. The internal diameter is a little larger than the screw to be extracted. The external diameter is small enough in most cases to allow the replacement of the screw by a larger one. The trephine fits directly into a Jacobs Chuck.

- SCET20** Extraction Trepine For 2.0mm Screws o/d 2.7mm
- SCET24** Extraction Trepine For 2.4mm Screws o/d 3.5mm
- SCET27** Extraction Trepine For 2.7mm Screws o/d 3.5mm
- SCET35** Extraction Trepine For 3.5mm Screws o/d 4.5mm
- SCET45** Extraction Trepine For 4.5mm Screws o/d 5.5mm

Equipment & Screw Boxes AO Screw/Equipment Boxes



BX20CS

BX2735CS

Please note design may vary with size of implant

- BX20CS** Box For 2.0mm AO Screws & Equipment
- BX24CS** Box For 2.4mm AO Screws & Equipment
- BX2735CS** Box For 2.7mm/3.5mm AO Screws & Equipment

Screw Boxes For AO Type Screws &/Or Locking Screws



Please note design may vary with size of implant

- SH1500** Screw Box 1.5mm AO Type Screws &/Or Locking Screws (All Lengths)
- SH2000** Screw Box 2.0mm AO Type Screws &/Or Locking Screws (All Lengths)
- SH2400** Screw Box 2.4mm AO Type Screws &/Or Locking Screws (All Lengths)
- SH2700** Screw Box 2.7mm AO Type Screws &/Or Locking Screws (All Lengths)
- SH2735** Screw Box 2.7mm & 3.5mm AO Type Screws &/Or Locking Screws (All Lengths of 2.7mm & All Lengths Of 3.5mm Up To 50mm)
- SH3500** Screw Box 3.5mm AO Type Screws &/Or Locking Screws (Up To 50mm)
- SH4500** Screw Box For 4.5mm AO Type Screws (Even Number Lengths From 12-50mm)

External Fixation

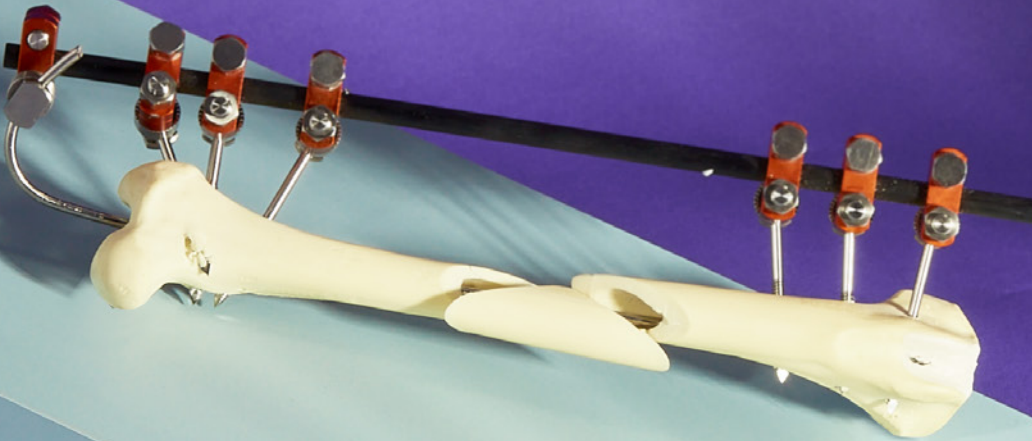

To view the External Fixation section of our website, please scan the QR code:



ESF Pins

Positive Threaded Pins

Positive threaded pins are the pin of choice for ESF application as they have excellent resistance to pull-out, and no inherent point of weakness.

End threaded pins are used as half pins in Type IA and IB ESF frames.

Centre threaded pins are used as full pins in Type II frames.

Positive Threaded Pins - Cortical

End Thread



The fine threads of these pins are proud of the shank eliminating the weak point where the thread ends in other pins.

The major benefit of positive threaded pins is that the additional thread diameter creates a larger bone pin interface for a given shaft diameter.

This style of pin is useful where a good pull out resistance is required and where it is anticipated that the frames will be left in situ for long periods - 6 weeks plus.

- CET0014** 0.8mm Shank 1.1mm Threads 60mm Long - End Thread
- CET0013** 1.0mm Shank 1.3mm Threads 65mm Long - End Thread
- CET0015** 1.2mm Shank 1.5mm Threads 65mm Long - End Thread
- CET0016** 1.2mm Shank 1.6mm Threads 70mm Long - End Thread
- CET0017** 1.4mm Shank 1.8mm Threads 70mm Long - End Thread
- CET0018** 1.6mm Shank 2.0mm Threads 70mm Long - End Thread
- CET0026** 1.8mm Shank 2.2mm Threads 80mm Long - End Thread
- CET0019** 2.0mm Shank 2.4mm Threads 85mm Long - End Thread
- CET0020** 2.4mm Shank 3.2mm Threads 100mm Long - End Thread
- CET0020A** 2.7mm Shank 3.5mm Threads 110mm Long - End Thread
- CET0020B** 3.0mm Shank 3.8mm Threads 120mm Long - End Thread
- CET0021** 3.2mm Shank 4.0mm Threads 130mm Long - End Thread
- CET0024A** 3.5mm Shank 4.3mm Threads 130mm Long - End Thread
- CET0022** 4.0mm Shank 4.8mm Threads 150mm Long - End Thread

Mid Thread



The Mid Threaded Pin provides good pull out resistance in frames where the fixation pins are supported on either side of the limb by connecting bars. i.e. Type II frames.

- CMT0013** 0.8mm Shank 1.1mm Threads 85mm Long - Mid Thread
- CMT0014** 1.1mm Shank 1.4mm Threads 85mm Long - Mid Thread
- CMT0015** 1.2mm Shank 1.5mm Threads 85mm Long - Mid Thread
- CMT0016** 1.4mm Shank 1.8mm Threads 85mm Long - Mid Thread
- CMT0017** 1.6mm Shank 2.0mm Threads 85mm Long - Mid Thread*
- CMT0018** 1.6mm Shank 2.0mm Threads 85mm Long - Mid Thread**
- CMT0018A** 1.8mm Shank 2.2mm Threads 90mm Long - Mid Thread
- CMT0019** 2.0mm Shank 2.4mm Threads 105mm Long - Mid Thread
- CMT0019A** 2.2mm Shank 2.6mm Threads 105mm Long - Mid Thread
- CMT0023** 2.4mm Shank 3.2mm Threads 105mm Long - Mid Thread
- CMT0023A** 2.7mm Shank 3.5mm Threads 115mm Long - Mid Thread
- CMT0023B** 3.0mm Shank 3.8mm Threads 120mm Long - Mid Thread
- CMT0024** 3.2mm Shank 4.0mm Threads 130mm Long - Mid Thread
- CMT0024A** 3.5mm Shank 4.3mm Threads 140mm Long - Mid Thread
- CMT0025** 4.0mm Shank 4.8mm Threads 150mm Long - Mid Thread

*CMT0017 has a 16mm thread length.

**CMT0018 has a 20mm thread length.

Positive Threaded Pins - Cancellous



The coarser threads of these pins are appropriate for use in metaphyseal bone.

- CANET0026** 2.4mm Shank 3.5mm Threads 115mm Long Cancellous End Thread
- CANET0027** 3.2mm Shank 4.8mm Threads 150mm Long Cancellous End Thread
- CANMT0029** 2.4mm Shank 3.5mm Threads 150mm Long Cancellous Mid Thread
- CANMT0030** 3.2mm Shank 4.8mm Threads 180mm Long Cancellous Mid Thread

Trochar Pins



The smooth shanks of trochar pins provide minimal pull out resistance, there is therefore little advantage to their use. When used, trochar pins should be placed at diverging angles to maximise pull-out resistance. 130mm long.

- 001556** Trochar Pin 2mm
- 001557** Trochar Pin 3mm
- 001558** Trochar Pin 4mm

Cortical Negative Threaded Pins Ellis Type



The short fine negative thread engages the trans (far) cortex and the smooth shank engages the cis (near) cortex.

The thread/shank junction (the weakest part of the pin) is positioned in the medullary cavity and protected from potential failure.

Ellis type pins have better pull out resistance over Trochar pins and the angle of placement is not as critical.

		Pin Diameter	Overall Length
001528	Ellis Pin	1.1mm	76mm
001529	Ellis Pin	1.6mm	85mm
001533	Ellis Pin	1.8mm	127mm
001550	Ellis Pin	2.0mm	127mm
001530	Ellis Pin	2.4mm - (3/32")	127mm
001550A	Ellis Pin	2.7mm - (7/64")	127mm
001551	Ellis Pin	3.0mm	127mm
001531	Ellis Pin	3.2mm - (1/8")	127mm
001551A	Ellis Pin	3.5mm	127mm
001552	Ellis Pin	4.0mm	127mm

Bicortical Negative Threaded Pins



Bicortical Negative Pins have had a bad reputation for early failure at the thread pin junction. Where selection of pin and frame are appropriate, failure of negative threaded pins is rare.

The important criterion is thread diameter not shaft diameter. For any given thread diameter both positive and negative threaded pins are equally strong.

	Shaft Diameter	Thread Diameter	Thread Length	Overall Length
BCNET08	0.8mm	0.8mm	8mm	70mm
BCNET10	1.0mm	1.0mm	10mm	70mm
BCNET11	1.1mm	1.1mm	12mm	70mm
BCNET13	1.3mm	1.3mm	12mm	70mm
BCNET15	1.5mm	1.5mm	12mm	70mm
BCNET16	1.6mm	1.6mm	20mm	70mm
BCNET18	1.8mm	1.8mm	24mm	85mm
BCNET20	2.0mm	2.0mm	24mm	85mm
BCNET24	2.4mm	2.4mm	25mm	100mm
BCNET27	2.7mm	2.7mm	30mm	110mm
BCNET30	3.0mm	3.0mm	35mm	130mm
BCNET35	3.5mm	3.5mm	40mm	130mm
BCNET40	4.0mm	4.0mm	45mm	150mm
BCNET50	5.0mm	5.0mm	50mm	150mm

Pre-Drilling ESF Pin Tracts



Pre-drilling a pin tract hole in the bone into which the ESF pin is subsequently inserted is very important as the ESF pins do not have drilling ends. Insertion of an ESF pin directly into the bone may cause impaction, micro-fracturing of the bone and excessive heat production with bone necrosis, all of which can lead to pin loosening. A drill bit that is about 10% smaller than the shank (core) diameter of the pin, or at least 0.1mm smaller should be used. A slow speed (electric) drill at about 150rpm is advisable, using flush to cool the pin and minimise heat generated in the bone that could cause bone necrosis and pin loosening. An appropriate drill guide is used to protect the soft tissues and minimise drill wobble and skidding. Once the hole is drilled, a K-wire can be used to maintain the pin tract (before the drill guide is removed) so it can be easily re-identified once the ESF pin is ready to be inserted.

- H090202** 1.9mm Pre-Drill For 2.0mm Shank Positive Pin
- H090203** 2.3mm Pre-Drill For 2.4mm Shank Positive Pin
- H090205** 3.0mm Pre-Drill For 3.2mm Shank Positive Pin
- H090207** 3.8mm Pre-Drill For 4.0mm Shank Positive Pin
- H090101** 1.5mm Pre-Drill For 2.0mm Shank Negative Pin
- H090102** 2.0mm Pre-Drill For 2.4mm Shank Negative Pin
- H090104** 2.7mm Pre-Drill For 3.2mm Shank Negative Pin
- H090106L** 3.5mm Pre-Drill For 4.0mm Shank Negative Pin

Safety Cutter Surgical Finish To 4mm Capacity



Safety implant cutter which leaves a smoother cut end than a conventional cutter. Very useful for external fixation pins. Cut end is temporarily retained within the head rather than flying off.

Maximum capacity 4mm. Cuts 5mm below the face of the cutter.

Telescopic handles reduce the overall length from 470mm to 340mm to fit most autoclaves. Head strips for cleaning.

001229 Safety Cutter Stainless Steel Cuts To 4.0mm Capacity 340mm Long

ESF Tissue Protector



Protection of soft tissue is very important when placing an ESF frame. Protection prevents tissues from getting wrapped around the drill bit, and helps to maintain access to the pin tract in the bone.

Once a connecting bar with clamps is in position, pin placement through a drill guide presents a specific problem because standard drill guide tissue protectors cannot be removed once the pin is in position.

The ESF Tissue Protector splits along its length to allow removal. The tip has small serrations to encourage grip on the bone surface.

001548 ESF Tissue Protector

Standard Fixators (SF)



001740	Mini Single Clamps	x8	H090202	Hard Drill 1.9mm Pre-Drill For 2.0mm Shank Pins	x1
001741	Small Single Clamps	x8			
001742	Large Single Clamps	x8	H090112	2.5mm Round Shank Drill Hard 115mm	x1
CET0019	2.0/2.4 End Threaded Pins 85mm Long	x4	H0901055	3.2mm Round Shank Drill Hard 130mm	x1
CMT0019	2.0/2.4 Mid Threaded Pins 105mm Long	x2	001566	Small Spanner 7mm	x1
CET0020A	2.7/3.5 End Threaded Pins 110mm Long	x4	001565	Medium Spanner 8mm	x1
CMT0023A	2.7/3.5 Mid Threaded Pins 115mm Long	x2	001564	Large Spanner 10mm	x1
CET0024A	3.5/4.3 Positive End Thread 130mm Long	x4	001548	External Fixation Tissue Protector	x1
CMT0024A	3.5/4.3 Mid Threaded Pins 140mm Long	x2	001578	Stainless ESF Box With Partitions	x1
001560	Small KE & Mini SF 1/8" Connecting Bar 150mm Long	x2	001864C	Carbon Fibre Bar 6.3mm x 200mm	x2
			001872C	Large 3/8 (9.5mm) Bar x 200mm - Carbon	x2

0017695SC SF Full Kit With Steel/Carbon Bars

SF Clamps

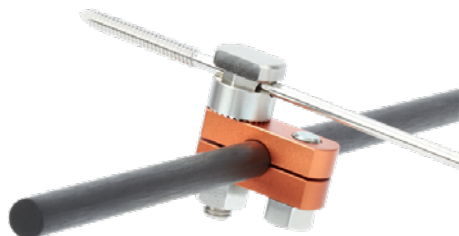

The Standard Fixator is the most adaptable standard linear ESF fixation system and is the recommended system to use. The ESF clamp design is a 2 part, 2 bolt mechanism body which can be dismantled. This means that ESF clamps can easily be added or removed from an ESF frame at any time, and by using two rather than one bolt to secure the clamp, better stability of the clamp-connecting bar and clamp-ESF pin interface is achieved.

The system is available in three different sizes, Mini, Small, and Large, as shown in the table below.

Clamp	Pin Shaft Dia	Bar Dia	Spanner
Mini	0.9mm - 2.5mm	3.2mm	7mm (001566)
Small	2.0mm - 3.2mm	6.3mm	8mm (001565)
Large	3.2mm - 4.8mm	9.5mm	10mm (001564)

SF Bars



Connecting bars for the mini system are 3.2mm stainless steel. The small system has carbon fibre and titanium 6.3mm connecting bars, and the large system has 9.5mm carbon fibre and aluminium connecting bars. Carbon fibre is radiolucent meaning that the connecting bar does not obscure the image when a radiograph is taken. Considering bending strength, Titanium is stiffer than carbon fibre which in turn is stiffer than aluminium.

SF Mini Range

001740	Mini Single Clamp
001743	Mini Double Clamp
001595	Mini 1/8" (3.2mm) Bar x 30mm Stainless Steel
001559	Mini 1/8" (3.2mm) Bar x 50mm Stainless Steel
001590	Mini 1/8" (3.2mm) Bar x 75mm Stainless Steel
001596	Mini 1/8" (3.2mm) Bar x 100mm Stainless Steel
001573	Mini 1/8" (3.2mm) Bar x 125mm Stainless Steel
001560	Mini 1/8" (3.2mm) Bar x 150mm Stainless Steel
001574	Mini 1/8" (3.2mm) Bar x 175mm Stainless Steel
001575	Mini 1/8" (3.2mm) Bar x 200mm Stainless Steel
SL2015	Insert Drill Sleeve 2.0mm O/D 1.5mm I/D
SL2418	Insert Drill Sleeve 2.4mm O/D 1.8mm I/D
001566	Spanner 7mm

SF Small Range

001741	Small Single Clamp
001744-A	Small Double Clamp
001862C	Small 1/4"(6.3mm) Bar x 100mm Carbon
001863C	Small 1/4"(6.3mm) Bar x 150mm Carbon
001864C	Small 1/4"(6.3mm) Bar x 200mm Carbon
001865C	Small 1/4"(6.3mm) Bar x 250mm Carbon
001866C	Small 1/4"(6.3mm) Bar x 300mm Carbon
001862TI	Small 1/4"(6.3mm) Bar x 100mm Titanium
001863TI	Small 1/4"(6.3mm) Bar x 150mm Titanium
001864TI	Small 1/4"(6.3mm) Bar x 200mm Titanium
001865TI	Small 1/4"(6.3mm) Bar x 250mm Titanium
SL3525	Insert Drill Sleeve 3.5mm o/d 2.5mm I/D
001565	Spanner 8mm

SF Large Range

001742	Large Single Clamp
001745	Large Double Clamp
001870C	Large 3/8"(9.5mm) Bar x 100mm Carbon
001871C	Large 3/8"(9.5mm) Bar x 150mm Carbon
001872C	Large 3/8"(9.5mm) Bar x 200mm Carbon
001873C	Large 3/8"(9.5mm) Bar x 250mm Carbon
001874C	Large 3/8"(9.5mm) Bar x 300mm Carbon
001870TI	Large 3/8"(9.5mm) Bar x 100mm Aluminium
001871TI	Large 3/8"(9.5mm) Bar x 150mm Aluminium
001872TI	Large 3/8"(9.5mm) Bar x 200mm Aluminium
001873TI	Large 3/8"(9.5mm) Bar x 250mm Aluminium
001874TI	Large 3/8"(9.5mm) Bar x 300mm Aluminium
SL4532	Insert Drill Sleeve 4.5mm O/D 3.2mm I/D
001564	Spanner 10mm

KE Plus

The KE Plus linear ESF system is an evolution of the original KE system. Although it is a versatile system that has functioned well over time, it has no advantage over the SF system.

The KE Plus clamp is designed to allow a wider range of positive threaded pins to be used than the original KE clamp, but clamp stability and security is not as good as the SF system.

KE Plus is compatible with existing KE systems and is a useful addition to expand the range of the KE system. KE Plus clamps have a matt finish compared with the polished standard KE clamps. The KE Plus system is available in small, medium and large sizes.

One important limitation of the KE Plus system is that once the fixator has been applied to the patient, additional clamps cannot be added or removed from the connecting bar without removing the entire fixator, disassembling, and starting from the beginning. This is because the clamps cannot pass those already present on the connecting bar.

Boxed KE+ ESF Kits



001579ND Kit List:

001525	Large Single KE Plus Clamp	x8
001526	Medium Single KE Plus Clamp	x8
001527	Small Single KE Plus Clamp	x8
001560	Small KE & Mini SF 1/8" Connecting Bar 150mm Long	x2
001564	Large Spanner 10mm	x1
001565	Medium Spanner 8mm	x1
001566	Small Spanner 7mm	x1
001578	Stainless ESF Box With Partitions	x1
001585	Large 5/16" Connecting Bar 240mm Long	x2
001589	Medium 3/16" Connecting Bar 200mm Long	x2
001548	External Fixation Tissue Protector	x1

001579NDP Kit List:

H090203	Hard Drill 2.3mm Pre-Drill For 2.4mm Shank Pins 125mm	x1
H090205	Hard Drill 3mm Pre-Drill For 3.2mm Shank Pins	x1
H090207	Hard Drill 3.8mm Pre-Drill For 4mm Shank Pins	x1
001525	Small Single KE Plus Clamp	x8
001526	Medium Single KE Plus Clamp	x8
001527	Large Single KE Plus Clamp	x8
001560	Small KE & Mini SF 1/8" Connecting Bar 150mm Long	x2
001564	Large Spanner 10mm	x1
001565	Medium Spanner 8mm	x1
001566	Small Spanner 7mm	x1
001578	Stainless ESF Box With Partitions	x1
001585	Large 5/16" Connecting Bar 240mm Long	x2
001589	Medium 3/16" Connecting Bar 200mm Long	x2
001548	External Fixator Tissue Protector	x1
CET0020	Positive End Thread Pin 2.4mm Shank 3.2mm Thread 100mm Long	x4
CET0021	Positive End Thread Pin 3.2mm Shank 4.9mm Thread 130mm Long	x4
CET0022	Positive End Thread Pin 4mm Shank 4.8mm Thread 150mm Long	x4
CMT0023	Positive Mid Thread Pin 2.4mm Shank 3.2mm Thread 105mm Long	x2
CMT0024	Positive Mid Thread Pin 3.2mm Shank 4mm Thread 130mm Long	x2
CMT0025	Positive Mid Thread Pin 4mm Shank 4.8mm Thread 150mm Long	x2

001579ND KE Plus Kit in Stainless Steel Box - No Double Clamps Pins or Drills
001579NDP KE Plus Kit in Stainless Steel Box - Includes Pins and Drills. No Double Clamps

Single KE Plus Clamp



Medium KE Plus with large positive pin



Medium KE Plus with small positive pin

Double Clamps



Used to attach a connecting bar to another connecting bar.

Connecting Bars

Connecting Bars are available in 5/16" (8mm) for large clamps, 3/16" (4.8mm) for medium clamps and 1/8" (3.2mm) for small clamps.

The thicker the bar, the stronger the frame. The shorter the bar between bone fragments, the stronger the frame. Rigidity is important early in fracture healing.

When significant callus is present, it is often helpful to introduce some slight axial motion by either removing some pins or moving the clamps further away from the bone. This is known as staging down or dynamising.

Bars are available in a variety of lengths.

KE Plus Small Range

001527	Small Single KE Plus Clamp
001594	Small Double Clamp
001595	Small Connecting Bar 1/8" (3.2mm) x 30mm
001559	Small Connecting Bar 1/8" (3.2mm) x 50mm
001590	Small Connecting Bar 1/8" (3.2mm) x 75mm
001596	Small Connecting Bar 1/8" (3.2mm) x 100mm
001573	Small Connecting Bar 1/8" (3.2mm) x 125mm
001560	Small Connecting Bar 1/8" (3.2mm) x 150mm
001574	Small Connecting Bar 1/8" (3.2mm) x 175mm
001575	Small Connecting Bar 1/8" (3.2mm) x 200mm
001566	Spanner 7mm

KE Plus Medium Range

001526	Medium Single KE Plus Clamp
001592	Medium Double Clamp
001588	Medium Connecting Bar 3/16" (4.8mm) x 75mm
001576	Medium Connecting Bar 3/16" (4.8mm) x 100mm
001587	Medium Connecting Bar 3/16" (4.8mm) x 150mm
001589	Medium Connecting Bar 3/16" (4.8mm) x 200mm
001589XL	Medium Connecting Bar 3/16" (4.8mm) x 250mm
001589XXL	Medium Connecting Bar 3/16" (4.8mm) x 300mm
001598	ESF Hinge Joint Medium
001565	Spanner 8mm

KE Plus Large Range

001525	Large Single KE Plus Clamp
001584	Large Double Clamp
001586	Large Connecting Bar 5/16" (8mm) x 100mm
001563	Large Connecting Bar 5/16" (8mm) x 150mm
001585	Large Connecting Bar 5/16" (8mm) x 240mm
001549	Large Connecting Bar 5/16" (8mm) x 340mm
001564	Spanner 10mm

Spanners



Standard spanners are available for all clamp sizes see reference chart.

- 001566 Spanner 7mm
- 001565 Spanner 8mm
- 001564 Spanner 10mm

Spanner & Clamp Reference Chart

Clamp Type	Clamp Size	Clamp Code	Spanner Size	Spanner Code
KE+	Small	001527	7mm	001566
	Medium	001526	8mm	001565
	Large	001525	10mm	001564
SF Clamps Single	Mini	001740	7mm	001566
	Small	001741	8mm	001565
	Large	001742	10mm	001564
SF Clamps Double	Mini	001743	7mm	001566
	Small	001744-A	8mm	001565
	Large	001745	10mm	001564

Epoxy ESF Putty

Epoxy ESF Putty is a simple to use, quick and convenient alternative to the standard bar and clamp system. The putty, once mixed, stiffens in 5 minutes and within 1 hour is fully cured. The putty can be applied and then the fracture reduced allowing precise manipulation of the fracture site. The versatility of the system allows the putty to be used in place of clamps, to cover sharp ends of cut pins, and many other applications.

There are two pack sizes in a bar format with the premeasured catalyst in the centre of the bar ready for mixing. The product is clean and has a long shelf life. Only mix the quantity you need, cutting the required amount off the end of the bar. If you find you don't have enough, more can be prepared in a matter of seconds. ESF putty sticks to itself very well and may be used for repairs and corrections. Particularly useful in fractures in small furries where proximal and distal fragments may be attached together with 'blobs' of putty in place of clamps regardless of fixation pin site.

Typical Applications

- ESF applications requiring multiple pins of various sizes placed at various angles
- ESF applications in rabbits and guinea pigs
- Fractures of the jaw
- Protecting sharp ends of cut pins
- Joining non-standard pins and bars
- Use to add a pin mid-frame



- EPOXY1 Epoxy ESF Putty 55g
- EPOXY2 Epoxy ESF Putty 110g

ESF Box

- 001578 ESF Box With Partitions



Email Marketing Service

Our marketing emails are designed to **educate**, to keep you up to date with what's new at Vi and share **exclusive offers and discounts**.

Sign up today by scanning the QR code below.



FESSA External Fixation

FESSA - Stainless Steel

Developed for use in the French army FESSA is a lightweight tubular fixator with a number of interesting features.

- The tube incorporates the pin clamping mechanism and is thus very strong and has extremely good angular pin rigidity
- Available in 6mm, 8mm and 12mm diameter tubes
- 6mm tube accepts pins of shaft diameter 0.9mm to 1.8mm making it extremely useful in the management of fractures in cats and exotics
- 8mm tube accepts pins of shaft diameter 1.6mm to 3.2mm
- 12mm tube accepts pins of shaft diameter up to 4mm and M5 grub screws
- Design allows placement of multiple parallel pins close together in small fragments
- Pins can be placed at right angles to tube or angled through adjacent holes. Pins are locked into position by hex driven grub screws



The full kit list is available upon request.

015500 FESSA 6 & 8mm Set With 10 of Each Screw

6mm FESSA

- 015502** FESSA Tube 6mm x 30mm
- 015504** FESSA Tube 6mm x 45mm
- 015506** FESSA Tube 6mm x 65mm
- 015508** FESSA Hex Driver Allen Key Type 1.5mm
- 015509** FESSA 6mm (1.5 Hex) Grub Screws (10)
- 015534** FESSA 6mm Hinge

8mm FESSA

- 015510** FESSA Tube 8mm x 100mm
- 015512** FESSA Tube 8mm x 150mm
- 015514** FESSA Tube 8mm x 200mm
- SDHS20-1** 1.5/2.0/2.4mm Hex Screwdriver & Screw Holding Sleeve
- 015517** FESSA Hex Driver Allen Key Type 2.0mm
- 015520** FESSA 8mm (2.0 Hex) Grub Screws (10)
- 015536** FESSA 8mm Hinge

12mm FESSA

- 015540** FESSA Tube 12mm x 125mm
- 015542** FESSA Tube 12mm x 175mm
- 015544** FESSA Tube 12mm x 225mm
- 015545** FESSA 12mm (2.5 Hex) Grub Screws (10)
- SDHS35POM-C** 2.5mm Hex Screwdriver + Sleeve With PTFE Handle

FESSA Ultra-Lightweight Titanium



Standard stainless steel FESSA is light. The tubular structure acts as both clamp and bar. Birds, small furries and exotics demand even lighter constructs.

Using Titanium tube of 5.0mm in diameter enables the surgeon to apply FESSA constructs weighing from as little as 1.5 grams.

Titanium FESSA tubes (015521 and 015522) are both supplied with 6x M3 grub screws. Suitable for pins 0.8mm to 1.6mm. Uses 1.5 hex drivers, the same as 6.0mm FESSA.



The full kit list is available upon request.

015530 Titanium FESSA Set In Stainless Steel Box

To view our Surgery Guide on 'Linear External Skeletal Fixation', please scan the QR code below.



Pin Reference Chart

	Bar Diameter	Small 3.2mm 1/8"	Medium 4.8mm 3/16"	Large 8mm 5/16mm	Mini 3.2mm 1/8"	Small 6.3mm 1/4"	Large 9.5mm 1/3"
		KE Plus	KE Plus	KE Plus	Standard SF	Standard SF	Standard SF
Code	Shaft Diameter						
Positive Threaded Pins - End Thread							
CET0014	Positive End Thread Pin 0.8mm Shank 1.1mm Thread 60mm Long						
CET0013	Positive End Thread Pin 1.0mm Shank 1.3mm Thread 65mm Long	●			●		
CET0015	Positive End Thread Pin 1.2mm Shank 1.5mm Thread 65mm Long	●			●		
CET0016	Positive End Thread Pin 1.2mm Shank 1.6mm Thread 70mm Long	●			●		
CET0017	Positive End Thread Pin 1.4mm Shank 1.8mm Thread 70mm Long	●			●		
CET0018	Positive End Thread Pin 1.6mm Shank 2mm Thread 70mm Long	●	●		●		
CET0026	Positive End Thread Pin 1.8mm Shank 2.2mm Thread 80mm Long	●	●	●	●		
CET0019	Positive End Thread Pin 2mm Shank 2.4mm Thread 85mm Long	●	●	●	●	●	
CET0020	Positive End Thread Pin 2.4mm Shank 3.2mm Thread 100mm Long	●	●	●	●	●	
CET0020A	Positive End Thread Pin 2.7mm Shank 3.5mm Thread 110mm Long	●	●	●		●	
CET0020B	Positive End Thread Pin 3mm Shank 3.8mm Thread 120mm Long		●	●		●	●
CET0021	Positive End Thread Pin 3.2mm Shank 4mm Thread 130mm Long		●	●		●	●
CET0024A	Positive End Thread Pin 3.5mm Shank 4.3mm Thread 130mm Long		●	●			●
CET0022	Positive End Thread Pin 4mm Shank 4.8mm Thread 150mm Long		●	●			●
Positive Threaded Pins - Mid Thread							
CMT0013	Positive Mid Thread Pin 0.8mm Shank 1.1mm Thread 85mm Long						
CMT0014	Positive Mid Thread Pin 1.1mm Shank 1.4mm Thread 85mm Long				●		
CMT0015	Positive Mid Thread Pin 1.2mm Shank 1.5mm Thread 85mm Long				●		
CMT0016	Positive Mid Thread Pin 1.4mm Shank 1.8mm Thread 85mm Long				●		
CMT0017*	Positive Mid Thread Pin 1.6mm Shank 2mm Thread 85mm Long	●	●		●		
CMT0018*	Positive Mid Thread Pin 1.6mm Shank 2mm Thread 85mm Long	●	●		●		
CMT0018A	Positive Mid Thread Pin 1.8mm Shank 2.2mm Thread 90mm Long	●	●		●		
CMT0019	Positive Mid Thread Pin 2mm Shank 2.4mm Thread 105mm Long	●	●	●	●	●	
CMT0019A	Positive Mid Thread Pin 2.2mm Shank 2.6mm Thread 105mm Long	●	●	●		●	
CMT0023	Positive Mid Thread Pin 2.4mm Shank 3.2mm Thread 105mm Long	●	●	●		●	
CMT0023A	Positive Mid Thread Pin 2.7mm Shank 3.5mm Thread 115mm Long	●	●	●			●
CMT0023B	Positive Mid Thread Pin 3mm Shank 3.8mm Thread 120mm Long		●	●			●
CMT0024	Positive Mid Thread Pin 3.2mm Shank 4mm Thread 130mm Long		●	●			●
CMT0024A	Positive Mid Thread Pin 3.5mm Shank 4.3mm Thread 140mm Long		●	●			●
CMT0025	Positive Mid Thread Pin 4mm Shank 4.8mm Thread 150mm Long		●	●			●
Trochar Pins							
001556	2.0mm Trochar Pin	●	●		●	●	
001557	3.0mm Trochar Pin	●	●	●		●	●
001558	4.0mm Trochar Pin		●	●			●

* different thread lengths available, see bottom of page 138 for reference.

Pin Reference Chart Continued

	Bar Diameter	Small 3.2mm 1/8"	Medium 4.8mm 3/16"	Large 8mm 5/16mm	Mini 3.2mm 1/8"	Small 6.3mm 1/4"	Large 9.5mm 1/3"
		KE Plus	KE Plus	KE Plus	Standard SF	Standard SF	Standard SF
Code	Shaft Diameter						
Cortical Negative Threaded Pins - Ellis Type							
001528	1.1mm Ellis Pin	○			○		
001529	1.6mm Ellis Pin	○			○		
001533	1.8mm Ellis Pin	○	○		○		
001550	2.0mm Ellis Pin	○	○		○	○	
001530	2.4mm Ellis Pin	○	○	○	○	○	
001550A	2.7mm Ellis Pin	○	○	○		○	
001551	3.0mm Ellis Pin	○	○	○		○	
001531	3.2mm Ellis Pin	○	○	○		○	○
001551A	3.5mm Ellis Pin	○	○	○			○
001552	4.0mm Ellis Pin	○	○	○			○
Bicortical Fine Negative Threaded Pins							
BCNET08	0.8mm Bicortical Negative End Thread Pin 70mm						
BCNET10	1mm Bicortical Negative End Thread Pin 70mm	○			○		
BCNET11	1.1mm Bicortical Negative End Thread Pin 70mm	○			○		
BCNET13	1.4mm Bicortical Negative End Thread Pin 70mm	○			○		
BCNET15	1.5mm Bicortical Negative End Thread Pin 70mm	○			○		
BCNET16	1.6mm Bicortical Negative End Thread Pin 70mm	○			○		
BCNET18	1.8mm Bicortical Negative End Thread Pin 85mm	○	○		○		
BCNET20	2mm Bicortical Negative End Thread Pin 85mm	○	○		○	○	
BCNET24	2.4mm Bicortical Negative End Thread Pin 100mm	○	○	○	○	○	
BCNET27	2.7mm Bicortical Negative End Thread Pin 110mm	○	○	○		○	
BCNET30	3mm Bicortical Negative End Thread Pin 130mm	○	○	○		○	
BCNET35	3.5mm Bicortical Negative End Thread Pin 130mm	○	○	○			○
BCNET40	4mm Bicortical Negative End Thread Pin 150mm		○	○			○
BCNET50	5mm Bicortical Negative End Thread Pin 150mm		○	○			

Surgical Power Tools

5



To view the Surgical Power Tool section
of our website, please scan the QR code:





We are delighted to continue our partnership with B. Braun Medical Ltd.

The Acculan 4 Small Drill and TPLO Saw meet all needs for veterinary surgeries in a compact, yet powerful and simple to use system. Constructed to the ergonomics of the hand and delivering technology which is synonymous with reliability and longevity.

AESCLAP® Acculan 4

Acculan 4 Small Drill

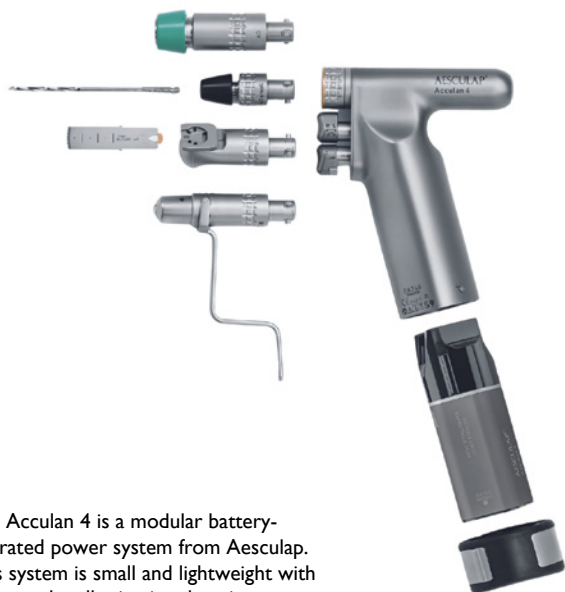

The Acculan 4 is a modular battery-operated power system from Aesculap. This system is small and lightweight with a easy to handle titanium housing.

Drill includes:

- GA678 - Sterile Funnel
- GA344244 - K-Wire Protection Guide
- GB600880 - Sterilit Spray Adapter
- TA011944 - Cleaning Brush for Acculan 4 and Accessories

- GA344 Acculan 4 Small Drill
- GA675 Acculan 4 Lid

Acculan 4 Small Drill Attachments

- GB881R Acculan 4 Large Jacobs Chuck 0.5-7.4mm
- GB884R Acculan 4 Small AO Chuck Attachment
- GB891R Acculan 4 Sagittal Saw Attachment
- GB892R Acculan 4 Reciprocating Saw Attachment
- GB894R Acculan 4 K-Wire Driver 0.6-3.2mm
- GB870R Acculan 4 Reamer Attachment Large Jacobs Chuck

Acculan 4 Sagittal Saw Blades

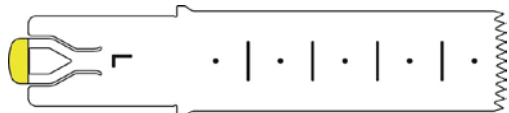

Supplied in single sterile packs.

	Length (mm)	Width (mm)	Cut Thickness (mm)
GP501SU	15	5	0.5
GP502SU	15	10	0.5
GP504SU	20	5	0.5
GP505SU	20	10	0.5
GP514SU	25	5	0.7
GP515SU	25	10	0.7
GP516SU	25	15	0.7
GP521SU	35	5	0.5
GP522SU	35	10	0.7
GP523SU	35	15	0.7
GP524SU	35	20	0.7
GP535SU	50	10	0.8
GP536SU	50	15	0.8
GP537SU	50	20	0.9
GP538SU	50	25	0.9
GP539SU	50	30	0.9

Acculan 4 TPLO Saw



The Acculan 4 TPLO Saw has a straight ergonomic design with titanium housing. The triangular mount allows use of Aesculap or Vi TPLO blades.

- GT666 Acculan 4 TPLO Straight Handpiece
- GA675 Acculan 4 Lid

Acculan 4 Battery and Charging Unit



Battery can be used with Acculan 4 Small Drill and TPLO Saw. Charger can be used with both NiMH and Li-Ion batteries.

- GA320 Acculan 4 Battery Charging Unit
- TE734 UK Mains Cable
- GA346 Acculan 4 Li-Ion Battery

Surgical Power Tool Lubrication

- GB600 Sterilit Power System Oil Spray
- GB600880 Sterilit Oil Spray Adaptor For GA344

Acculan 4 Storage

Can be used with Acculan 4 small drill and TPLO saw.



- JF282R Basket For JN096
- JF289R Basket Lid For JF282R
- JF938 Silicone Mat Mesh Fitting 1/2 Basket
- JN096 Dental Sterile Container & Lid

Acculan 4 Accessories

- GA678 Sterile Funnel
- GA679 Battery Removal Device
- GA344244 K-Wire Protection Guide For Small Drill
- JK091 Sterile Container Reusable Filter Pack of 2
- TA011944 Cleaning Brush for Acculan 4 and Accessories

Acculan 4 Large Drill and Reamer Handpiece and Attachments available on request.

A wider range of products are available.
Please contact us for specific requirements.



DeSoutter Vdrive™ System

The DeSoutter Vdrive™ veterinary range is lightweight and fully modular and comprises a large and small bone system which share a common battery platform.

V-MBQ Large Bone Powered Instrument Range

The V-MBQ is suitable for large bone surgery, with a unique TPLO attachment. A single handpiece will cover all large bone veterinary procedures with its comprehensive range of attachments. All attachments in this range will fit both pistol grip and straight case handpieces to accommodate all surgeons' preferences.



DS1291884 V-MBQ-708 Vdrive™ Modular Handpiece - Twin Trigger



DS1293774 V-MBQ-807 Vdrive™ Modular Straight Case Handpiece

V-MBQ Attachments

Fit both V-MBQ-708 twin trigger handpiece and V-MBQ-807 straight case handpiece.

- DS18320** V-DQ-708 Vdrive™ Keyed Chuck 0.5-6.4mm (1/4") For MBQ
- DS18330** V-DQ-708 Vdrive™ Small AO Synthes/ASIF Chuck For MBQ
- DS18440** V-RQ-708 Vdrive™ Keyed Reamer Attachment 0.5-7.4mm (1/4") For MBQ
- DS18300** V-NQ-707 Vdrive™ Small Sagittal Saw Uses S88 Blades For MBQ
- DS18690** V-OQ-708 Vdrive™ TPLO Oscillating Saw. Uses R Series & Synthes Blades For MBQ
- DS18270** V-OQ-708 Vdrive™ TPLO Oscillating Saw. Uses Slocum Blades For MBQ
- DS18310** V-WQ-707 Vdrive™ Wire Driver. 0.7 - 4.0 mm wire capacity For MBQ

- 6 months warranty for battery
- 12 months warranty on hand pieces and attachments

V-MBU Small Bone Powered Instrument Range

The V-MBU is suitable for small bone surgery. High speed and oscillating drilling, low speed drilling, screw driving and tapping. There is no TPLO attachment to fit the small bone handpiece.



DS1292444 V-MBU-470 Vdrive™ Modular Handpiece - Twin Trigger

V-MBU Attachments

- DS18780** V-DU-470 Vdrive™ Keyed Chuck 0.5-4.0mm (5/32") For MBU
- DS18770** V-DU-470 Vdrive™ Keyed Chuck 0.5-7.4mm (1/4") For MBU
- DS18800** V-DU-470 Vdrive™ AO Synthes/ASIF Chuck For MBU
- DS18820** V-RU-470 Vdrive™ Keyed Reamer 0.5-7.4mm (1/4") For MBU
- DS18870** V-SU-470 Vdrive™ Mini Sagittal Saw Uses S85 Blades For MBU
- DS18880** V-NU-470 Vdrive™ Quick Release Sagittal Saw Uses S88 Blades For MBU
- DS18910** V-WU-471 Vdrive™ Wire/Pin Driver 0.7 – 4.0mm Capacity For MBU

Aseptic Small Batteries For Vdrive™

Can be used with both large V-MBQ and small V-MBU handpieces. Multi bay charger available.

- DS17910** AB-703 Vdrive™ Small Battery Pack (10.95V)
- DS18850** V-AH-703 Vdrive™ Battery Housing for AB-703 Battery
- DS18100** AS-703 Vdrive™ Battery Shield for AB-703 Battery
- DS18000** BC-707 Single Bay Charger for AB-703 Battery

Large battery (14.6V) and sterilisable Lithium Ion batteries available on request.

Blades

S85 blades fit DS18870 V-SU-470 mini sagittal saw for small bone handpiece (MBU)

	Length (mm)	Width (mm)	Cut Thickness (mm)
S85-103	22	6	0.7
S85-100	23	10	0.7
S85-110	35	10	0.7

All listed supplied as a sterile single blade. Other blades are available to buy in packs of 5.

S88 blades fit DS18300 V-NQ-707 small sagittal saw for large bone handpiece (MBQ) and DS18880 V-NU-470 quick release sagittal saw for small bone handpiece (MBU).

	Length (mm)	Width (mm)	Cut Thickness (mm)
S88-103	22	6.4	0.6
S88-100	25	10	0.6
S88-110	35	10	0.6
S88-109	46	15	0.6

All listed supplied as a sterile single blade. Other blades are available to buy in packs of 5.

Vi Black Series Battery Powered Drill/Saw Set



The Vi Black Series Drill/Saw Set contains:

- Black Series Drill
- Black Series Saw
- 1x Battery Charger
- 2x Batteries
- 2x Battery Transfer Sleeves
- 2x Storage Cases

BLACKKITUK Vi Black Series Drill & Saw Set UK

Vi Black Series Battery Charger



VIBLKCHGUK Vi Black Series Battery Charger (UK)
BLACKBAT Vi Black Series Spare Battery

- 6 months warranty for battery
- 12 months warranty on hand pieces

Vi Black Series Battery Powered Drill



Supplied complete with battery, battery charger, battery transfer sleeve and storage case.

The drill has a reverse and is fitted with a 4.8mm capacity three jaw chuck with 3.0mm through cannulation for driving smaller pins, wires and drill bits.

Drill max speed: 0-1100RPM
 Drill max noise: <40dB
 Drill weight: 990g

BLACKDRILL Vi Black Series Drill
BLACKCHUCKKEY Vi Black Series Drill Spare Chuck Key

Vi Black Series Attachment



Designed for use with the Black Series Drill, this attachment converts the Jacobs chuck to a quick-release chuck, allowing the use of AO/quick release drill bits and attachments.

BLACKDRILL-QRAC Vi Black Series Cannulated QR Attachment

Vi Black Series Battery Powered Surgical Saw



Supplied complete with battery, battery charger, battery transfer sleeve, storage case and 1x BLACKSW451607B blade.

Saw speed: 0-15000 osc/min
 Saw max noise: <50dB
 Saw weight: 782g

BLACKSAW Vi Black Series Saw

Vi Black Series Saw Blades

We stock a range of Black Series Saw Blades which have been specifically designed for Veterinary patients.

Ideal for TTA/TTO style cruciate surgeries, other elective osteotomies and excisional arthroplasty.

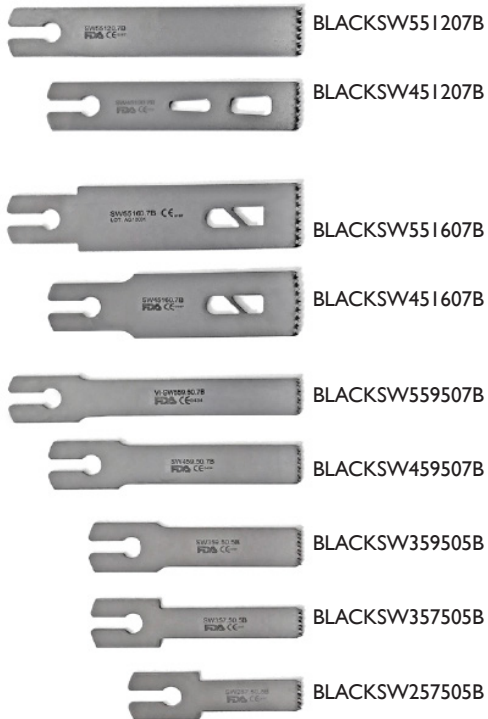

Blades not to scale

	Cut Thickness	Working Length	Width
BLACKSW257505B	0.75	20	7.5
BLACKSW357505B	0.75	30	7.5
BLACKSW359505B	0.75	30	9.5
BLACKSW459507B	0.95	40	9.5
BLACKSW451207B	0.95	40	12
BLACKSW451607B	0.95	40	16
BLACKSW559507B	0.95	50	9.5
BLACKSW551207B	0.95	50	12
BLACKSW551607B	0.95	50	16

Black Series Aluminium Sterilisation Cases

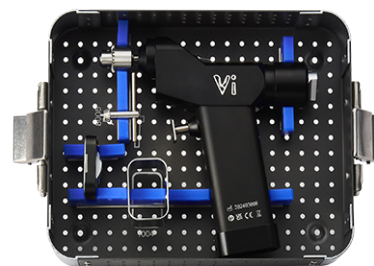

Designed specifically for the Vi Black Series Drill and Saw and suitable for use in larger autoclaves. Cases outer dimensions are 300x205x70mm.

- BLACKDRILL-SC** Sterilisation Case For Black Series Drill
- BLACKSAW-SC** Sterilisation Case For Black Series Saw

Vi Battery Powered TPLO Saw



Supplied with:

- Transportation Case
- Saw
- Batteries x2
- Battery Charger
- Battery Transfer Sleeve

A sterilisation case is also available (see page 227).

- VITPLOSAW** Vi Battery Powered TPLO Saw
- VITPLOSAW-SC** Vi TPLO Sterilisation Case
- VITPLOCHG** Vi TPLO Saw Battery Charger (UK Plug)
- VITPLOBAT** Vi TPLO Saw Replacement Battery
- ALLEN25** 2.5mm Allen Key Stainless Finish
- GRUBM5L5** Grub Screw M5 x 5mm
- TPLOSAWLID** TPLO Saw Lid

TPLO Saw Blades Vi Pattern



Vi's updated TPLO Blade has been redesigned to further reduce friction and improve cut characteristics in all sizes.

- TPLOVI12** TPLO Blade Vi Pattern 12mm
- TPLOVI13.5** TPLO Blade Vi Pattern 13.5mm
- TPLOVI15** TPLO Blade Vi Pattern 15mm
- TPLOVI18** TPLO Blade Vi Pattern 18mm
- TPLOVI21** TPLO Blade Vi Pattern 21mm
- TPLOVI24** TPLO Blade Vi Pattern 24mm
- TPLOVI27** TPLO Blade Vi Pattern 27mm
- TPLOVI30** TPLO Blade Vi Pattern 30mm
- TPLOVI34** TPLO Blade Vi Pattern 34mm

TPLO Saw Blade 9mm



Vi are pleased to offer a 9mm radial cut TPLO blade by Rita Leibinger. Standard triangular mount fitting.

- TPLOBLEI09** Rita Leibinger 9mm TPLO Saw Blade

TPLO Saw Hex Driver T Bar Type



The fitting on most TPLO saw blades is of the triangular Stryker Type. The means of attachment to the saw is by hex drive grub screws which are notorious for working loose.

Our T Bar hex drivers allow the surgeon to quickly, easily and firmly attach the blade to the saw.

Available in 2.5mm (Slocum), 3.0mm (Aesculap) and 3.2mm (Whittemore/Vi).

- TBHEX25** 2.5mm T Bar Hex Driver (Slocum)
- TBHEX30** 3.0mm T Bar Hex Driver (Aesculap)
- TPLOHEX32** 1/8" Stainless Allen Key (Whittemore/Vi)
- ALLEN25** 2.5mm Allen Key Stainless
- 015508** 1.5mm Allen Key
- 015517** 2.0mm Allen Key

TPLO Saw Blade Protractor



Use to accurately measure the tibial plateau slope. In addition the protractor is marked with blade outline to further assist in the planning of the TPLO procedure.

- TPLOPRO** TPLO Protractor

Description	Vi Code	Hex Driver	Vi Code
Whittemore Saw Grub Screw	TPLOSCREW	1/8"	TPLOHEX32 (Allen Key)
Slocum Saw Screw	SLOSCREW	2.5MM	TBHEX25 (T BAR)
Aesculap Saw Grub Screw	SPECIAL ORDER FROM AESCULAP	3.0MM	TBHEX30 (T BAR)
TPLO Jigs	JIGSCREW	2.5MM	TBHEX25 (T BAR)
Arthroscopic Distractor	JIGSCREW	2.5MM	TBHEX25 (T BAR)
FESSA 6mm	015509	1.5MM	015508 (Allen Key)
FESSA 8mm	015520	2.0MM	015517 (Allen Key)

Multi Saw Battery Powered System

This multi-functional oscillating saw can be used for powered bone dissection, where an oscillating motion is required and also acts as a dedicated cast cutter.

The saw is supplied as a kit and includes a charging unit, two batteries, and a blade.



- 001708** Multi Saw Surgical Kit incl Converter, Shroud, Titanium Nitride Coated Blade & S82-103 Blade
- 001708.134** Multi Saw Surgical Kit incl Converter, Shroud, Titanium Nitride Coated Blade & SB5071-134 Blade Suitable for TTO & TTA Rapid
- 001702** Stainless Converter supplied with spanner
- 001703** Waterproof Shroud For Multi Saw
- 001705** Multi Saw Diamond Blade
- 001714** Multi Saw Titanium Nitride Coated Blade
- M12B2MIL** Spare Battery For Milwaukee Multi Saw and Drill
- M1218FCMIL** Charging Unit For Milwaukee Batteries 240V

Surgical Blades

All blades with a central hole bigger than 6mm will fit the Multi Saw.

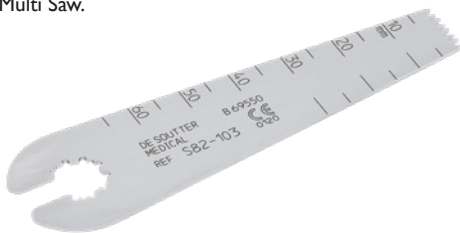

	THICKNESS	CUT	LENGTH	WIDTH
S82-100	0.46mm	0.9mm	42mm	13mm
S82-103	0.81mm	1.2mm	70mm	12mm
S82-104	0.81mm	1.2mm	70mm	25mm
SB5071-134	0.38mm	0.6mm	41mm	9.0mm
SB5071-133	0.38mm	0.6mm	25mm	9.5mm
S85-110	0.4mm	0.7mm	33mm	10.0mm

Multi Saw Blades



Actual Size



Actual Size



Actual Size

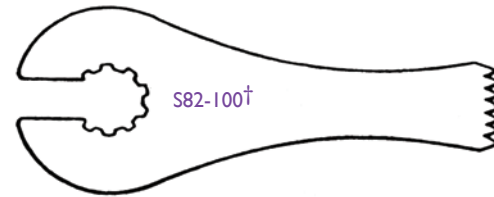

Actual Size

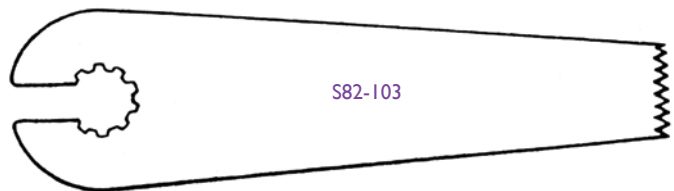

Actual Size

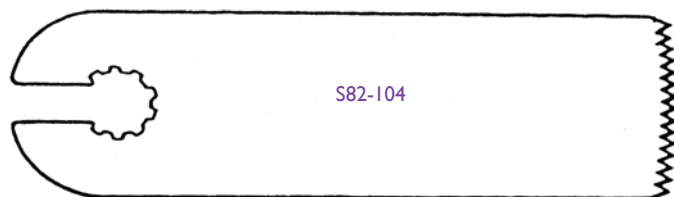

Actual Size

Variable Speed Orthopaedic Drill (Milwaukee) & Accessories

The drill system is from an industrial background, modified for the Animal Health industry.

- Excellent control over speed 0-600rpm via trigger
- Stainless Steel Chuck (6.35mm capacity) and Extension
- 80mm through Chuck cannulation
- Autoclavable Shroud
- Low Speed, High Torque
- Supplied as a Complete Kit including Stainless Chuck, Key, Extension, Autoclavable Shroud, 2 Batteries and a Charger.



- 001600** Variable Speed Orthopaedic Drill (Milwaukee) Kit - Drill, Chuck, Key, Shroud, Extension & 2x Batteries
- 001605** Spare Chuck and Key 1/4" 6.35mm
- 001606** Spare Key For Standard Chuck
- 001607** Drill Extension
- 001661A** Waterproof Shroud
- M12B2MIL** Spare Battery For Milwaukee Multi Saw and Drill
- M1218FCMIL** Charging Unit For Milwaukee Batteries 240V
- 001620** Waterproof Drill Shroud for Pre-2014 Makta Style Drill



Loan Kits

For a nominal fee, we have a range of **specialist loan kits** available to complement your own fleet. With next working day availability, the service offers flexibility as procedures are booked with your clients.

To find out more, scan the QR code below.



MiniDriver Basic Set



VIMDB2 MiniDriver Basic Set Including MK 2 Saw

K200 MiniDriver Handpiece



Fully re-furbished to the new K200 standard, the handpiece is the centre of the modular system.

Handpiece has forward and reverse button plus locking trigger.

Power output with medical air at 7bar input is 0.78 Newton Meters.

Speed variable 0-1100rpm.

K200VI K200 Handpiece

K111 Wire Driver



Re-attachment of osteotomies or small bone fragments is often best achieved using K or arthrodesis wires. Driving a long pin in a chuck often results in bending and kinking making driving difficult. Incrementally advancing the wire through a chuck is often time consuming. The wire driver allows the easy incremental advancement of the wire through the handpiece via the use of a clutch arrangement.

K111VI Wire Driver 0.7mm To 1.8mm

K211 Pin Driver



Similar to the wire driver in operation the pin driver has a larger capacity 1.6m to 4mm.

K211VI K211 Pin Driver 1.6 To 4mm

K110 Small 4mm Jacobs Chuck



The 4mm chuck attachment is cannulated for driving long pins.

K110VI K110 4mm Chuck Attachment Including Key

K109 Large 6.25mm Jacobs Chuck



The 6.25mm chuck attachment is cannulated for driving long pins.

K109VI K109 6.25mm Chuck Attachment Including Key

K210 Hi Torque Large 6.25mm Jacobs Chuck



Using the standard chucks the MiniDriver has a torque of 0.78 Newton Meters, which makes heavy weather of driving large pins without pre-drilling.

By adding a set of gears the chuck speed is reduced but the stall torque is increased to 2.8 Newton Meters ideal for driving pins.

K210VI K210 Hi Torque 6.25mm Chuck Attachment

K107VI Keyless Chuck Attachment



Chuck keys wear quickly, become lost and can be awkward to use in some situations. The keyless chuck allows the surgeon to quickly switch drills and pins without a key.

The distal part of the chuck is held using fingers and the chuck opened or closed by engaging the drill in either the forward or reverse drive respectively. The downside is that the chuck is slightly bulkier than the keyed equivalent.

K107VI Keyless Chuck Attachment 0 - 6.3mm

K114B AO Quick Release Attachment



Drills may be changed quickly without the use of a chuck key. The original version was made from relatively soft aluminium. The re-manufactured K114B is made from stainless steel and is easier to use than the original.

K114BVI K114B AO Quick Release Attachment

K220 Blades



	CUT THICKNESS	LENGTH	WIDTH
K142	1.0mm	30.0mm	6.4mm
K144	1.0mm	30.0mm	10.2mm
K146	0.65mm	27.4mm	19.0mm
K147	0.65mm	27.4mm	14.0mm
K149	0.65mm	42.7mm	19.1mm
K154	0.65mm	42.7mm	9.5mm
K155	0.65mm	42.7mm	14.0mm

K220 Mark II Sagittal Saw



The Mark II Saw is more robust in construction than the K120 Saw. Blade attachment is by use of a Hex Wrench. While this gave a more rigid attachment of the blade to the saw it was also the weak point of the attachment.

We have re-engineered the blade holding mechanism to make it stronger and made the whole attachment from stainless steel.

The Mark II Saw drives a larger range of blades including longer ones up to 42mm useful in the TTO and TTA procedures.

K220VI K220 Mark II Sagittal Saw Attachment

K201VI Replacement Wrench For K220VI

K120 Blades



	CUT THICKNESS	LENGTH	WIDTH
K123	1.0mm	15.1mm	10.4mm
K124	1.0mm	31.0mm	10.4mm
K125	1.0mm	15.1mm	16.5mm
K132	0.7mm	31.0mm	6.4mm
K133	0.7mm	15.1mm	10.4mm

MiniDriver Hose

The standard hose is a 3m long double hose which vents back at the wall gas outlet or the regulator. In the UK the standard drive gas is bottle sterile medical air delivered at 7bar (100psi). Elsewhere in the world nitrogen may be used.

The standard hose supplied is fitted with an MA7 gas probe (medical air at 7bar) which prevents connection to other gases e.g. oxygen.

3MH0SEVI MiniDriver Hose

3MH0SEVIUS MiniDriver Hose US Schrader

Air Hoses

What do I need?

To get the correct hose you will need to know two things – the make/model of instrument the hose is to fit, and the type of supply outlet you have.

Outlet connectors cause most fitting issues. Most usual outlet – UK MA7. This will only accept UK MA7 probes. If your hose pushes in, but will not click home, the hose usually has a US Schrader fitting. Hoses sourced outside the UK and USA are very unlikely to be compatible with UK outlets as each country has its own connectors for safety reasons.

Hose outlet connectors are shown with the relevant outlet. Schrader hoses can be as shown but can also have no gutter round the probe.

A UK MA7 probe will fit a Schrader socket, but a Schrader probe will NOT fit a UK MA7 outlet without a special adaptor.

UK MA7



SCHRADER



Common Instrument Connectors:



3M Connector – fits MiniDriver, MicroDriver and Minos A200.



Halls Connector - fits most Halls Air Tools, Surgairtome Spinal System and many others.

Air Instrument Care Products



Maintenance will ensure continuing excellent performance and minimal repair bills. It's crucial to follow manufacturer's guidelines.

- M317** Lubricant for MiniDriver and Minos
- M316** Vi Air Instrument Oil 15ml
- M316L** Vi Air Instrument Oil 120ml

Air Regulators & Hose Probes

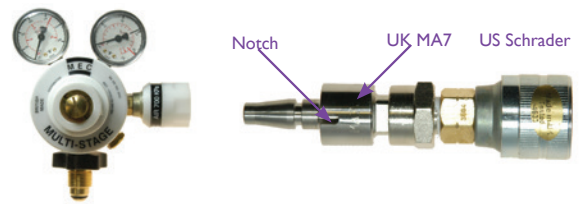

All the air equipment runs on medical air at 7 Bar (100PSI). Drills and saws can be run from compressors as their air requirement is intermittent. High speed drills need bottled gas or a big compressor. A twin dial regulator is best to control gas pressure (001756). One dial gives bottle pressure, the other one gives line pressure (7 Bar).

UK supplied hoses come with an MA7 probe (medical air 7 Bar pressure). Schrader fittings on hoses purchased from the USA look similar to UK MA7 probes. Many will however not lock into UK MA7 sockets. The best solution is to change the probe. A cheaper alternative is to use a Schrader/ MA7 Convertor (001758).

- 001756** Medical Air Regulator MA7 Outlet - Buy to order only
- 001758** MA7 Male to Schrader Female Plug in Adaptor

Halls (Linvatec) Spinal Bur System Surgairtome II



The Surgairtome II has an air brake, so the bur stops immediately the trigger is released.

- 505800-A** Surgairtome II Kit. Includes Hose Medium Bur Guard & Motor
- 5058** Surgairtome II Handpiece Only
- HALLHOSEVI** Vi Hose – Halls Fitting 3m Long

Bur Guards

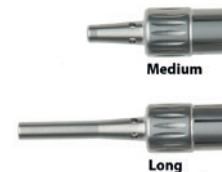

- VIMBG** Medium Bur Guard For Burs 45-51mm Long
- VILBG** Long Bur Guard For Burs 70mm Long

Halls Bur Guards



Spinning at 100,000 rpm the shaft needs support. These are the original Halls Guards.







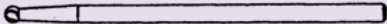
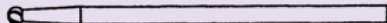
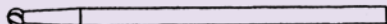

- 1375-023** Extra Long Halls Bur Guard
- 1375-011** Long Halls Bur Guard
- 1375-012** Medium Halls Bur Guard

Burs

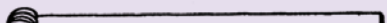
All surgical burs have a 2.36mm shank (HP fitting) and will fit in all high speed surgical bur systems e.g. 3M's Minos, Halls Surgairtome and Foredom.

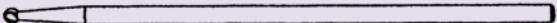
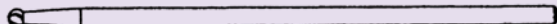
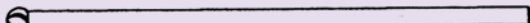
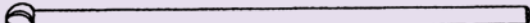
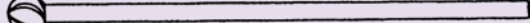
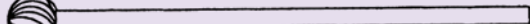
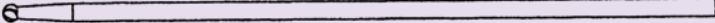
We have selected Komet burs for their high quality. All are single pack and non sterile. In human surgery, burs are regarded as disposable items. In veterinary surgery the cost precludes using burs as disposables. However, use of burs which are less than sharp extends procedure time and creates heat. We do advise that burs are checked and changed on a regular basis.

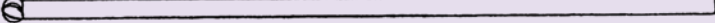
Diamond burs are sharper and create less heat than carbide equivalents. Adequate irrigation is essential.

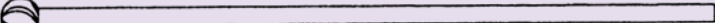
BURS		HEAD SIZE	OVREALL LENGTH	BUR GUARD	ORDER CODE (Carbide)	ORDER CODE (Diamond)
BUR TYPE	illustrations are actual size					
		1.4mm	51mm	Medium	M14R	
		1.8mm	51mm	Medium	M18R	
		2.0mm	51mm	Medium	M20R	M20D
		2.3mm	51mm	Medium	M23R	
		3.0mm	51mm	Medium	M30R	
		4.0mm	51mm	Medium	M40R	M40D
		5.0mm	51mm	Medium	M50R	
		6.0mm	51mm	Medium		M60D
		1.8mm	70mm	Long	L18R	
		2.0mm	70mm	Long	L20R	L20D
		2.3mm	70mm	Long	L23R	
		2.7mm	70mm	Long	L27R	
		3.0mm	70mm	Long	L30R	L30D
		3.5mm	70mm	Long	L35R	
		4.0mm	70mm	Long	L40R	L40D
		4.5mm	70mm	Long	L45R	
		5.0mm	70mm	Long	L50R	L50D
		6.0mm	70mm	Long	L60R	L60D
		2.0mm	95mm	Extra Long	X20R	X20D
		2.3mm	95mm	Extra Long	X23R	
		3.0mm	95mm	Extra Long	X30R	X30D
		4.0mm	95mm	Extra Long	X40R	X40D
		5.0mm	95mm	Extra Long	X50R	X50D

Bur Stands



001792BLOCK.ONLY

Bur Block Holds x6 Burs - Burs Not Included

Spinal Surgery

6



To view the Spinal Surgery area of our website, please scan the QR code:

Cervical Intervertebral Fusion Implant

C-LOX has been developed by Rita Leibinger in cooperation with Professor Dr. Frank Forterre, Bern University (Switzerland). Surgical protocol available on request.

C-LOX Complete Set



The C-LOX Complete Set:

- C-Lox Tray x1
- Screwdriver Handle Silicone x1
- C-LOX Screwdriver Shaft 2.7mm Star-Drive 135mm AO x1
- Locking Drill Guide 2.7 (1 of each size working end) x5
- C-LOX Implantation Placement Rod 22cm x2
- C-LOX Spinal Curette 22cm x1
- Bone Drill AO Shaft Ø 2.0 mm 100/75 mm x1
- Bone Drill AO Shaft Ø 2.5 mm 110/85 mm x1
- C-LOX Spinal Cage Titanium, 2,7mm H-Plate with Almond Cage Locking with Spikes (1 of each size) x10
- C-LOX Sizing Cage for Spinal Cage H-Plate with Almond Cage (1 of each size) x10
- Star Drive Spinal Cage Locking Screw Titanium x5 of each length

CLOX134010001 C-LOX Complete Set - New Version

C-LOX Screwdriver Handle



Silicone handle, sterilisable up to 134°.

CLOX247010200 C-LOX Screwdriver Handle

C-LOX Screwdriver Shaft 2.7mm



Star Drive T10, 135mm long. AO connection, self holding.

CLOX134080027 C-LOX Screwdriver Shaft 2.7mm

C-LOX Cages



- CLOX134-0144-08** CLOX Spinal Cage Titan 2.7mm H Plate Almond Cage 14mm x 4
- CLOX134-0146-08** CLOX Spinal Cage Titan 2.7mm H Plate Almond Cage 14mm x 6
- CLOX134-0164-08** CLOX Spinal Cage Titan 2.7mm H Plate Almond Cage 16mm x 4
- CLOX134-0165-10** CLOX Spinal Cage Titan 2.7mm H Plate Almond Cage 16mm x 5
- CLOX134-0166-08** CLOX Spinal Cage Titan 2.7mm H Plate Almond Cage 16mm x 6
- CLOX134-0167-10** CLOX Spinal Cage Titan 2.7mm H Plate Almond Cage 16mm x 7
- CLOX134-0185-10** CLOX Spinal Cage Titan 2.7mm H Plate Almond Cage 18mm x 5
- CLOX134-0187-10** CLOX Spinal Cage Titan 2.7mm H Plate Almond Cage 18mm x 7
- CLOX134-0206-12** CLOX Spinal Cage Titan 2.7mm H Plate Almond Cage 20mm x 6
- CLOX134-0208-12** CLOX Spinal Cage Titan 2.7mm H Plate Almond Cage 20mm x 8

C-LOX Spinal Cage Locking Screws

Self drilling 2.7mm locking titanium cortex screw with star drive head.

- CLOX245-427-10** CLOX Spinal Cage Locking Screw 12mm Thread Length 10mm
- CLOX245-427-12** CLOX Spinal Cage Locking Screw 14mm Thread Length 12mm
- CLOX245-427-14** CLOX Spinal Cage Locking Screw 16mm Thread Length 14mm
- CLOX245-427-16** CLOX Spinal Cage Locking Screw 18mm Thread Length 16mm
- CLOX245-427-18** CLOX Spinal Cage Locking Screw 20mm Thread Length 18mm
- CLOX245-427-20** CLOX Spinal Cage Locking Screw 22mm Thread Length 20mm

C-LOX Twist Drill



Anti-skid tip and length matched to C-LOX drill sleeve. AO fitment.

- CLOX148008120** C-LOX 2.0mm AO shaft Twist Drill Bit 100mm Long
- CLOX148008125** C-LOX 2.5mm AO shaft Twist Drill Bit 110mm Long

C-LOX Locking Drill Guides



Used with 2.0mm drills and 2.7mm screws.

- CLOX164002710** Locking Drill Guide 2.7mm 10mm Working End
- CLOX164002712** Locking Drill Guide 2.7mm 12mm Working End
- CLOX164002714** Locking Drill Guide 2.7mm 14mm Working End
- CLOX164002716** Locking Drill Guide 2.7mm 16mm Working End
- CLOX164002718** Locking Drill Guide 2.7mm 18mm Working End
- CLOX164002720** Locking Drill Guide 2.7mm 20mm Working End

C-Lox Spinal Disk Broaching Curette



Used for removing disk material and creating bed for cage. 220mm long.

CLOX134070022 C-LOX Spinal Disk Broaching Curette

C-Lox Implant Placement Rod



Threaded tip engages with trial cages and with implantable cages. 220mm long.

CLOX134075022 C-LOX Implant Placement Rod

C-Lox Distractor



Used to distract the intervertebral disk space. 90mm deep.

CLOX134075016 C-LOX Distractor 90mm Deep

Instrumentation

Percussion Mallet



Designed for consistent neurological examination.

001322 Percussion Mallet 180mm Long

Rongeurs & Punches

All rongeurs and spine forceps cut with one part of the jaw inserted into the compromised spinal canal.

Our spine instruments are designed to minimise the size of the lower jaw. In many cases this will reduce the cutting strength of the instrument which should only be used on appropriate bone thickness.

A selection of Rongeurs will be required.

Duck-Billed Daniel Rongeurs



Designed by Simon Wheeler BVSc PhD, these Rongeurs can remove full thickness lamina bone in small dogs.

They are however, best used to remove the layer of deep cortical bone overlying the spinal cord once the superficial cortex and cancellous bone have been removed using power tools; this is particularly true of the medium and large dog.

001400 Duck-Billed Daniel Rongeurs 3mm Bite 177mm Long

Daniel Rongeur



The jaws of this instrument are straight and the bite is small. Also suitable for bulla osteotomy.

001402 4mm Daniels Rongeurs 130mm Cvd

Micro Spine Rongeur Set



Very fine Rongeurs with a 1.75mm (width) bite. Set contains three variations, straight, curved and angled.

142600 Micro Spine Rongeurs Set of 3

Laminectomy Rongeurs



These Rongeurs have been developed specifically for Laminectomy in the dog.

001432 Laminectomy Rongeurs 2mm 160mm

001433 Laminectomy Rongeurs 3mm 160mm

Compound Action Spinal Rongeurs



Much more powerful than the Daniels, this instrument can nibble through full thickness lamina. The jaws are very fine and angled to allow the surgeon to enlarge the inter-vertebral foramen.

Available in 2mm, 3mm and 4mm jaw widths. Length 190mm.

001429 Compound Action Spinal Rongeurs 2mm

001430 Compound Action Spinal Rongeurs 3mm

001431 Compound Action Spinal Rongeurs 4mm

Lempert Straight



Useful for spines and bulla osteotomy.

6730/10 Lempert Rongeurs Straight 3mm Bite 190mm Long

Stille-Luer Rongeurs



A very large rongeur.

142305 Stille-Luer Heavy Compound Action Rongeurs Curved 8mm 225mm Long

Mini-Friedman



Useful in bulla osteotomy.

142501 Mini-Friedman Rongeur Curved 3mm Bite 160mm Long

Smith-Kerrison Punch Forceps



This is a traditional design with a 40 degree upward cutting jaw. Robust spine forceps. 185mm shaft.

001143 2mm Self Clearing Kerrisons

001445 Smith-Kerrison Punch Forceps 2mm

001446 Smith-Kerrison Punch Forceps 3mm

Micro-Friedman



A small spine rongeur.

142502 Micro-Friedman Rongeur Curved 2.2mm Bite 155mm Long

40° Bone Punch Forceps (Low Profile)



Designed for use where a high speed bur has removed the outer cortical layer and the underlying cancellous layer, the powerful nibbling action of this device allows very controlled removal of the final layer of cortical bone. The wedge-shaped foot of this device is designed to allow good access whilst still retaining strength, and is polished to minimise friction and potential trauma. Overall length 210mm.

001438 Batemans Spine Punch 40 Degree Upward Cut 2mm

001441 Batemans Spine Punch 40 Degree Upward Cut 4mm

Retractors & Distractors

Gelpi Odd Leg Retractor



The asymmetric pattern is most typically used for a dorsal approach to the spine, where the long arm extends deep to retract the longissimus dorsi muscle, as the short arm engages with axial structures. They are supplied in matched, opposite pairs to create a rectangular window of exposure.

001333 Gelpi Self Retaining Retractors Odd Leg 205mm Pair
001334 Gelpi Self Retaining Retractors Odd Leg 130mm Pair

Spike and Shield Odd Leg Retractor



Operates in a similar fashion to the odd leg Gelpis but the muscle retaining shield creates a wider field of view. Shield size 25 x 25mm. Supplied in pairs left and right.

001480 Spike and Shield Odd Leg Gelpi 180mm Pair

Cone Laminectomy Retractor



Similar in size to a Travers retractor but with articulated arms, the cone retractor allows a very flexible field of retraction, with the additional benefit that it can be folded away from the operation site. Maximum retraction, minimum interference.

001335 Cone Laminectomy Retractor 160mm Long

Small Spine Distractor



The tips of the small distractor are designed to fit into inter-vertebral spaces. The surfaces pushing against the end plates are serrated for maximum grip. Tips when closed 4mm. Overall length 140mm. Tips are staggered for easy introduction.

001491 Small Spine Distractor

McKee Distractor With Speedlock



The odd legs of this dedicated distractor engage the inter-vertebral space cranial to and caudal to the space involved.

The speedlock opens the disc space leaving it uncluttered by instrumentation.

090257 McKee Distractor With Speedlock 240mm

FitzExcavator Set



Designed and developed by Noel Fitzpatrick this excavator set includes all the necessary hand instruments for surgical management of canine inter-vertebral disc disease.

The set consists of 5 cutting instruments: one left, one right, plus 3 straight instruments 2.00mm, 1.00mm and 0.5mm.

Set also includes 001275 Molt Periosteal Elevator 4mm/6mm.

The six instruments are supplied in a stainless steel autoclavable case.

001428 FitzExcavator Set

Hand Instruments

Periosteal Elevator Very Fine



001272 Periosteal Elevator Very Fine 2mm/3mm 180mm Long

Chase Spinal Hook

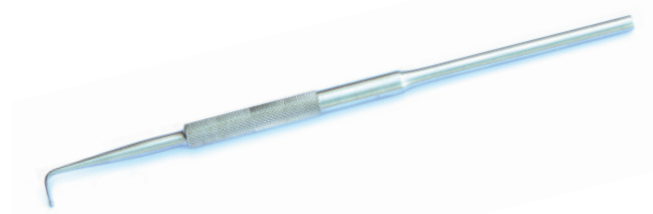

Based on a suggestion from Damian Chase. This probe is useful for manipulation of the spinal cord and nerve roots during certain surgeries.

001451 Chase Spinal Hook 8mm 90° Offset 145mm Long

Dandy Nerve Hook



The Dandy nerve hook is useful for manipulation of nerves and nerve roots. Also useful for manipulation of the medial meniscus during CCL procedures.

001408 Dandy Nerve Hook 1mm 190mm Long
001409 Dandy Nerve Hook 2mm 220mm Long

Bone Curette



Following requests for a House curette with smaller scoops. This is the smallest scoop we can provide whilst still being strong enough to elevate bone.

001412 Bone Curette 2.0mm Scoop 145mm Long

Freer Periosteal Elevator



The Freer elevator is a fine instrument which is particularly useful in spinal work.

7350/05 Freer Periosteal Elevator 5mm 180mm Long

House Curette

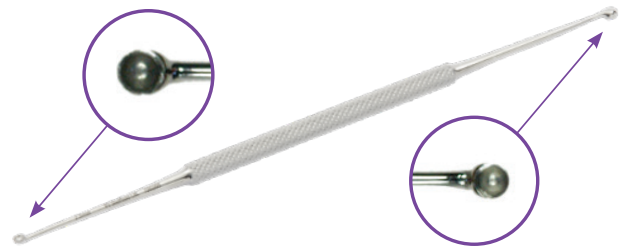

The House curette is a strong small curette to lift bone from around the spinal cord. Double ended 2.5mm and 3.0mm scoops.

7262/05 House Curette 2.5 & 3.0mm Scoops 150mm

Burley Disc Scoop



The Burley disc scoop is designed to remove material without repeated insertions into the disc space. As the scoop is moved around, the nuclear material travels along the channel and out.

001501 Burley Disc Scoop

Rosen Mobiliser



With care, intraneural canal structures can be manipulated. Removal of disc debris is essential to achieve decompression of the cord. The curved tip of this instrument is very useful.

7105/40S Rosen Mobiliser No.8 160mm

Sheas Curette



Fenestration of discs, particularly cervical discs, can be a useful procedure. The Sheas Curette is a very small scoop. 2.5mm in diameter.

001410 Sheas Disc Curette 2.5mm Diameter 170mm

Younger Good Scaler Jaquette Scaler

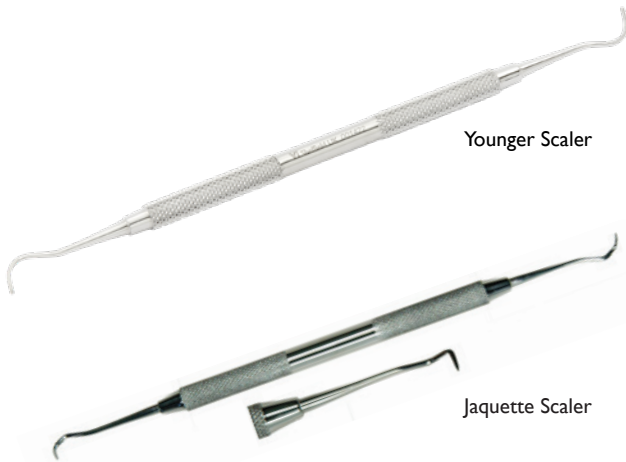

Younger Scaler

Jaquette Scaler

Both instruments are for the removal of wafer thin bone overlying the spinal cord during Laminectomy.

The Younger Good scaler is blunt-backed and useful for removal of disc material from both disc spaces and neural canal. This is not a standard scaler in that all the sharp surfaces are softened to minimise spinal trauma.

The Jaquette scaler is sharp and best suited to hooking out the final lamina.

001422 Younger Good Scaler 175mm

001424 Small Jaquette Scaler 165mm

Spinal Needles



405255 22g x 3" Spinal Needles Disposable Box of 25

405253 20g x 3.5" Spinal Needles Disposable Box of 25

405252 20g x 3" Spinal Needles Disposable Box of 25

J0529AN 18g x 6" Spinal Needle Disposable. Single Sterile

Bone Wax



It will not help you if you hit a venous sinus but will control the blood from cut cancellous bone which obscures the visual field. The wax physically blocks the blood vessels.

001460 Bone Wax 12 x 2.5g

Veterinary Instrumentation Bone Cement



Bone cement can be used for stabilising spinal fractures. Use screws or pins to provide 'keying' points.

Can also be used for distraction of the disc space using a small screw and filling the space with Gentamycin BCIG Bone Cement.

BCI High Viscosity - 40 Grams

BCIG High Viscosity With 20 Grams Gentamycin

BC3G Low Viscosity (Syringe) With 20 Grams Gentamycin

Lyostypt®



Lyostypt® is a wet-stable collagen haemostat. Collagen leads to thrombocyte adhesion and to activation of coagulation factor XII. 30 x 50mm. 12 units per pack.

- Achieves haemostatis very swiftly
- Is completely absorbable
- Can be removed easily
- Can be applied endoscopically
- Can be combined with fibrin glue and antibiotics

1069128 Lyostypt® (12 Units)



VETIGEL®

Exclusively available from Vi®

VETIGEL® is a haemostatic gel that is designed to stop moderate to severe bleeding within seconds. VETIGEL® helps control bleeding in animals by achieving haemostasis in seconds without the need for manual pressure.

VETIGEL® can be used on a variety of procedures, including but not limited to: dental extractions, oral mass removals, abdominal and thoracic mass removals, soft organ biopsies, enucleations, spays and neuters, amputations, venous and arterial bleeds, cholecystectomies, catheterisation, and lacerations.

VETIGEL® Haemostatic Gel



VET-02 VETIGEL Haemostatic Gel 2 x 5ml

VET-05 VETIGEL Haemostatic Gel 5 x 5ml

VETIGEL® Accessory Packs



ACC-01 VETIGEL Haemostatic Gel 2 x Accessory Packs

General Surgical



7

To view the General Surgical section of our website, please scan the QR code:



Ethicon Suture Range



Taper Cut (TC)
 ETHW3439 MONOCRYL 3-0 12x TC



Reverse Cutting (RC)
 ETHMCP3327G MONOCRYL PLUS 2-0 36x RC 26mm 3/8C
 ETHMCP4424H MONOCRYL PLUS 3-0 36x RC 19mm 3/8C
 ETHMCP3326G MONOCRYL PLUS 3-0 36x RC 26mm 3/8C
 ETHMCP292H MONOCRYL PLUS 4-0 36x RC 19mm 3/8C
 ETHMCP3209G MONOCRYL PLUS 5-0 36x RC 19mm 3/8C

Reverse Cutting Prime (RCP)
 ETHMCP497H MONOCRYL PLUS 3-0 36x RCP 19mm 3/8C
 ETHMCP3213H MONOCRYL PLUS 3-0 36x RCP 26mm 3/8C
 ETHMCP4423H MONOCRYL PLUS 3-0 36x RC 19mm 3/8C
 ETHMCP3205G MONOCRYL PLUS 4-0 36x RCP 16mm 3/8C
 ETHMCP498H MONOCRYL PLUS 4-0 36x RCP 19mm 3/8C
 ETHMCP496H MONOCRYL PLUS 4-0 36x RCP 19mm 3/8C UNDYED
 ETHMCP493H MONOCRYL PLUS 5-0 36x RCP 13mm 3/8C

Taper Cut (TC)
 ETHMCP3440G MONOCRYL PLUS 2.0 36x TC 26mm 1/2C

Taper Point (TP)
 ETHMCP219G MONOCRYL PLUS 3-0 36x TP 22mm 1/2C
 ETHMCP3435G MONOCRYL PLUS 4-0 36x TP 17mm 1/2C

Taper Point Plus (TP+)
 ETHMCP218H MONOCRYL PLUS 4-0 36x TP+ 22mm 1/2C



Reverse Cutting Prime (RCP)
 ETHW1626BH ETHILON 2-0 36x RCP 26mm 3/8C
 ETHW1685BH ETHILON 3-0 36x RCP 26mm 3/8C

Reverse Cutting (RC)
 ETHW320BG ETHILON 3-0 12x RC 26mm 3/8C
 ETH662G ETHILON 4-0 12x RC 19mm 3/8C



No Needle
 ETHW9026 VICRYL 0 12x NO NEEDLE
 ETHW9027 VICRYL 1 12x NO NEEDLE
 ETHW9025 VICRYL 2-0 12x NO NEEDLE
 ETHW9028 VICRYL 2 12x NO NEEDLE
 ETHW9024 VICRYL 3-0 12x NO NEEDLE

Reverse Spatula
 ETHW1703 VICRYL 9-0 12x RS 6,5mm 3/8C

Reverse Cutting (RC)
 ETHW9442 VICRYL 5-0 12x RC 16mm 3/8C

Reverse Cutting Prime (RCP)
 ETHW9500T VICRYL 6-0 24x RCP 11mm 3/8C



Taper Cut (TC)
 ETHVCP998H VICRYL PLUS 3-0 36x TC 26mm 1/2C
 ETHVCP999H VICRYL PLUS 2-0 36x TC 26mm 1/2C

Reverse Cutting (RC)
 ETHVCP395H VICRYL PLUS 3-0 36x RC 16mm 3/8C



Conventional Cutting (CC)
 ETHW9924 VICRYL RAPIDE 4-0 12x CC 16mm 3/8C

Reverse Cutting Prime (RCP)
 ETHW9933 VICRYL RAPIDE 2-0 12x RCP 26mm 3/8C
 ETHW9923 VICRYL RAPIDE 3-0 12xRCP 19mm 3/8C
 ETHW9922 VICRYL RAPIDE 4-0 12x RCP 19mm 3/8C
 ETHW9915 VICRYL RAPIDE 5-0 12x RCP 11mm 3/8C



- Taper Cut (TC)**
 ETHPDP9184H PDS PLUS 2-0 36x TC 26mm 1/2C
 ETHPDP9381H PDS PLUS 0 36x TC 36mm 1/2C
 ETHPDP9179H PDS PLUS 3-0 36x TC 26mm 1/2C
- Taper Point (TP)**
 ETHPDP317H PDS PLUS 2-0 36x TP 26mm 1/2C
- Taper Point Plus (TP+)**
 ETHPDP334H PDS PLUS 0 36x TP+ 26mm 1/2C
 ETHPDP9116H PDS PLUS 3-0 36x TP+ 20mm 1/2C
- Taper Cut Plus (TC+)**
 ETHPDP9124H PDS PLUS 3-0 36x TC+ 26mm 1/2C
- Reverse Cutting (RC)**
 ETHPDP9957H PDS PLUS 3-0 36x RC 26mm 3/8C
- Reverse Cutting Prime (RCP)**
 ETHPDP9626H PDS PLUS 2-0 36x RCP 26mm 3/8C



- ETHW8684G PROLENE 3-0 12 xRC 26mm 3/8C
 ETHW8977 PROLENE 2-0 12x TC 26mm 1/2C

DERMABOND™ ADVANCED™ and Mini Topical Skin Adhesives



ETHANX12 DERMABOND ADVANCED 0.7ML VIAL 12 E



ETHAHVM12 DERMABOND MINI HV 0.36ML VIAL 12 E

DERMABOND™ PRINEO™ Skin Closure System



ETHCLR222 DERMABOND PRINEO 22CM MSH 3.8ML ADHESIVE



ETHCLR422 DERMABOND PRINEO 42CM MSH 3.8ML ADHESIVE

ETHICON

NEEDLE SHAPES

1/4 Circle		• Eye • Microsurgery
3/8 Circle		• Dura • Eye • Fascia • Nerve
1/2 Circle		• Muscle • Eye • Skin • Peritoneum
Straight		• Nasal cavity • Nerve • Skin • Tendon
5/8 Circle		• Cardiovascular • Oral • Pelvis • Urogenital tract
Compound Curve		• Eye (Anterior segment)
J Shape		• Laparoscopy

ROUND BODIED NEEDLES

Taperpoint		Ethiguard	
Visi-black/Taperpoint Plus		CC	
Blunt Point		Tapercut	

CUTTING NEEDLES

Conventional cutting		Traditional Conventional cutting	
Reverse cutting		Prime Conventional Cutting	
PRIME		Prime Reverse Cutting	
PRIME MultiPass			
Trocar point			

Vi General Surgery Kit



Vi surgical instrument kits contain specifically selected high quality instrumentation for your small animal surgical needs.

The Vi General Surgery Kit contains:

584760	Mayo Needle Holder 140mm	x1
746100	Metzenbaum Scissors - Straight 145mm	x1
745300	Mayo Scissors Chamf Blades 140mm	x1
106625	Spencer Wells Artery Forceps - Curved 125mm	x2
106600	Spencer Wells Artery Forceps - Straight 125mm	x2
103175	Halstead Mosquito Forceps 125mm	x2
342005	Debaque Atraumatic Dissecting Forceps 150mm	x1
341200	Adson Serrated Dissecting Forceps 125mm	x1
341145	Dissecting Forceps 1/2 Teeth 150mm	x1
0803	Scalpel Handle No 3	x1
171566	Jones Cross Action Towel Clips	x4

VIGSKIT Vi General Surgery Kit

Vi General Surgery Kit - Left Handed



The Vi General Surgery Left Handed Kit contains:

171566	Jones Cross Action Towel Clips	x4
746100L	Metzenbaum Scissors - Straight 145mm - Left Handed	x1
745300L	Mayo Scissors Chamf Blades 140mm - Left Handed	x1
341145	Dissecting Forceps 1/2 Teeth 150mm	x1
106625L	Spencer Wells Artery Forceps - Cvd 125mm - Left Handed	x2
106600L	Spencer Wells Artery Forceps - Str 125mm - Left Handed	x2
103175L	Halstead Mosquito Forceps 125mm Left Handed	x2
342005	Debaque Forceps 150mm	x1
341200	Adson Serrated Dissecting Forceps 125mm	x1
585400L	Olsen Hegar Needle Holders - Left Handed	x1
0803	Scalpel Handle No 3	x1

VIGSKIT-L Vi General Surgery Kit Left Handed

Vi Basic Surgery Stitch Up Kit



Vi Basic Surgery Stitch Up Kit contains high quality instrumentation for your stitch up procedures.

The Vi basic surgery stitch up kit contains:

584760	Mayo Needle Holder 140mm	x1
745300	Mayo Scissors Chamf Blades 140mm	x1
106600	Spencer Wells Artery Forceps - Straight 125mm	x2
346850	Treves 1/2 Teeth Dissecting Forceps 125mm	x1
0803	Scalpel Handle No 3	x1

VIBSSKIT Vi Basic Surgery Stitch Up Kit

Left Handed Instrument Starter Kit



Vi offer a selection of left handed instruments, identified by one black handle.

The Left Handed Instrument Starter Kit contains:

585400L	Olsen Hegar Needle Holders - Left Handed	x1
745300L	Mayo Scissors Str 140mm - Left Handed	x1
746200L	Metzenbaum Scissors Str 145mm - Left Handed	x1
746110L	Metzenbaum Scissors Str 180mm - Left Handed	x1
103175L	Halstead Forceps Str 125mm - Left Handed	x2
103225L	Halstead Forceps Cof 125mm - Left Handed	x2
101780L	Crile Forceps Cof 140mm - Left Handed	x4
841350L	Backhaus Towel Clips - Left Handed	x4
341210	Adson Serrated Dissecting Forceps 125mm	x1
342005	Debaque Forceps 150mm	x1
0803	Scalpel Handle No 3	x1
BX201040	Stainless Steel Box 200mm X 100mm X 40mm	x1

LHKIT Left Handed Instrument Starter Kit

Left Handed Feline Spay Kit



The Vi Left Handed Feline Spay Kit contains:

BX201040	Instrument Box 200x100x40mm	x1
103225L	Halstead Forceps Cof 125mm - Left Handed	x2
014211	Spay Forceps 125mm	x1
341210	Adson Serrated Dissecting Forceps 125mm	x1
585400L	Olsen Hegar Needle Holders - Left Handed	x1
171566	Jones Cross Action Towel Clips	x2
106625L	Spencer Wells Artery Forceps - Cvd 125mm - Left Handed	x2
746101L	Metzenbaum Scissors Str 150mm - Left Handed	x2
0830	Scalpel Handle No 3	x1

SPAYFEL-L Cased Feline Spay Kit Left Handed

Left Handed Canine Spay Kit



The Vi Left Handed Canine Spay Kit contains:

BX221550	Instrument Box 220x150x50mm	x1
BXSIL2215	Silicone Insert For Instrument Box 220x150x50mm	x1
745300L	Mayo Scissors Chamf Blades 140mm - Left Handed	x1
171566	Jones Cross Action Towel Clips	x4
014307L	Carmault Forceps 200mm Cvd Left Handed	x2
341145	Dissecting Forceps 1/2 Teeth 150mm	x1
106630L	Spencer Wells Artery Forceps 150mm Cvd Left Handed	x4
801155L	Allis Tissue Forceps 3/4 Teeth 150mm	x2
605355L	Olsen Hagar TC Needleholder 165mm Left Handed	x1
0830	Scalpel Handle No 3	x1

SPAYCAN-L Cased Canine Spay Kit Left Handed



Loan Kits

For a nominal fee, we have a range of **specialist loan kits** available to complement your own fleet. With next working day availability, the service offers flexibility as procedures are booked with your clients.

To find out more, scan the QR code below.



Artery Forceps

Spencer Wells



Standard veterinary artery forceps.

106600	Spencer Wells Artery Forceps Str 12.5cm 5"
106605	Spencer Wells Artery Forceps Str 15cm 6"
106610	Spencer Wells Artery Forceps Str 18cm 7"
106615	Spencer Wells Artery Forceps Str 20cm 8"
106620	Spencer Wells Artery Forceps Str 23cm 9"
106621	Spencer Wells Artery Forceps Str 30cm 12"
106625	Spencer Wells Artery Forceps Cof 12.5cm 5"
106630	Spencer Wells Artery Forceps Cof 15cm 6"
106635	Spencer Wells Artery Forceps Cof 18cm 7"
106640	Spencer Wells Artery Forceps Cof 20cm 8"
106645	Spencer Wells Artery Forceps Cof 23cm 9"

Halstead Mosquito



Very light but adequate for routine haemostasis in all but the largest blood vessels.

103165	Halstead Mosquito Artery Forceps Str 10cm 4"
103170	Halstead Mosquito Artery Forceps Cof 10 cm 4"
103175	Halstead Mosquito Artery Forceps Str 12.5cm 5"
103225	Halstead Mosquito Artery Forceps Cof 12.5cm 5"
103180	Halstead Mosquito Artery Forceps 1/2 Teeth Str 12.5cm 5"
103185	Halstead Mosquito Artery Forceps 1/2 Teeth Cof 12.5cm 5"

Kocher



Similar to Rochester Peans, but with a 1/2 toothed tip for added security.

105520	Kocher Artery Forceps Cof 14cm 5.5"
105521	Kocher Artery Forceps Str 15cm 6"
105522	Kocher Artery Forceps Cof 15cm 6"

Rochester Pean



Long jaw forceps, useful as a hysterectomy clamp in cats and small-medium breed bitches.

106225	Rochester Pean Artery Forceps Str 14cm 5.5"
106230	Rochester Pean Artery Forceps Str 16cm 6.5"
106235	Rochester Pean Artery Forceps Str 18cm 7"
106236	Rochester Pean Artery Forceps Str 22cm 8.5"
106270	Rochester Pean Artery Forceps Cof 14cm 5.5"
106275	Rochester Pean Artery Forceps Cof 16cm 6.5"
106280	Rochester Pean Artery Forceps Cof 18cm 7"
106285	Rochester Pean Artery Forceps Cof 20cm 8"
106290	Rochester Pean Artery Forceps Cof 22cm 9"

Crile



Jaw is somewhat lighter than the more popular Spencer Wells Artery Forceps.

101750	Crile Artery Forceps Str 14cm 5.5"
101755	Crile Artery Forceps Atraumatic Jaws Str 14cm 5.5"
101765	Crile Artery Forceps Str 16cm 6.5"
101775	Crile Artery Forceps Str 18cm 7"
101780	Crile Artery Forceps Cof 14cm 5.5"
101785	Crile Artery Forceps Atraumatic Jaws Cof 14cm 5.5"
101795	Crile Artery Forceps Cof 16cm 6.5"
101800	Crile Artery Forceps Cof 18cm 7"

Negus Forceps



7018/05	Negus Artery Forceps Small Cof 18cm 7"
----------------	--

Kelly



106700	Kelly Artery Forceps Curved 14cm 5.5"
106710	Kelly Artery Forceps Straight 14cm 5.5"

Dieffenbach (Bulldog) Clamps



Small Cross Action Vascular Clamps. Most commonly used in soft tissue surgery.

- 107708 Dieffenbach (Bulldog) Clamp Str 5cm
- 107710 Dieffenbach (Bulldog) Clamp Cof 5cm

Mayo Safety Pin



Use to organise artery forceps and other similar instruments.

- 106699 Mayo Safety Pin

Ramplays Sponge Forceps



- 786505 Ramplays Sponge Forceps 25cm

Tissue Forceps

Allis



- 801150 Allis 2/3 Teeth 15cm 6"



- 801160 Allis 4/5 Teeth 15cm 6"



- 801165 Allis 5/6 Teeth 15cm 6"



- 801170 Allis 6/7 Teeth 15cm 6"

General purpose tissue forceps.

- 801150 Allis Tissue Forceps 2/3 Teeth 15cm 6"
- 801155 Allis Tissue Forceps 3/4 Teeth 15cm 6"
- 801156 Allis Tissue Forceps 3/4 Teeth 18cm 7"
- 801160 Allis Tissue Forceps 4/5 Teeth 15cm 6"
- 801161 Allis Tissue Forceps 4/5 Teeth 20cm 8" Angled
- 801165 Allis Tissue Forceps 5/6 Teeth 15cm 6"
- 801170 Allis Tissue Forceps 6/7 Teeth 15cm 6"
- 801175 Baby Allis Tissue Forceps 4/5 Teeth 13cm 5"

Babcock



An alternative to Allis. Less traumatic but less grip.

- 801350 Babcock 16.5cm 6.5"
- 801354 Babcock 18cm 7"
- 801355 Babcock 20cm 8"
- 801360 Babcock 23cm 9"

Youngs Tongue Forceps



- 7853/05 Youngs Tongue Forceps 17cm 6.5"
- 7853/05SPARE Youngs Tongue Forceps Spare Rubbers I Pair

Scalpel Blades & Handles

Morton Handles



- 0803 Scalpel Handle No 3
- 0804 Scalpel Handle No 4
- 0807 Scalpel Handle No 7
- 0814 Scalpel Handle No 4L
- 0923 Scalpel Handle No B3

Beaver Type Handle



- 06054 Vi Fine Beaver Type Scalpel Handle 130mm
- 06051 Fine Stainless Steel Beaver Type Scalpel Handle 130mm
- 06052 Fine Stainless Steel Beaver Type Scalpel Handle 100mm
- 06053 Fine Stainless Steel Beaver Type Scalpel Handle 80mm

Swann Morton Scalpel Blades



- 0201 Carbon Sterile Blades 10
- 0203 Carbon Sterile Blades 11
- 0205 Carbon Sterile Blades 15
- 0207 Carbon Sterile Blades 21
- 0210 Carbon Sterile Blades 23
- 0211 Carbon Sterile Blades 24

Swann Morton Fine Blades Beaver Type



- 05901 Fine Stainless Steel Blades SM61 Box of 25
- 05902 Fine Stainless Steel Blades SM62 Box of 25
- 05903 Fine Stainless Steel Blades SM63 Box of 25
- 05904 Fine Stainless Steel Blades SM64 Box of 25
- 05905 Fine Stainless Steel Blades SM65 Box of 25
- 05906 Fine Stainless Steel Blades SM65A Box of 25
- 05907 Fine Stainless Steel Blades SM67 Box of 25
- 05908 Fine Stainless Steel Blades SM68 Box of 25
- 05909 Fine Stainless Steel Blades SM69 Box of 25

Scalpel Handles & Blades			
Code	Scalpel Size	Handle Length	Blade Size
0803	No. 3 Handle with Scale	12cm	10, 11, 12, 15
0923	No. B3 Handle	12.8cm	10, 11, 12, 15
0807	No. 7 Handle	16cm	10, 11, 12, 15
0804	No. 4 Handle	13cm	21, 22, 23, 24
0814	No. 4 Long Handle	21cm	21, 22, 23, 24

Surgical Scissors

Surgical scissors are typically either one of two designs. The Mayo is the general purpose surgical scissor in which the blade occupies approximately one third of the length of the scissor. The 14cm straight Mayo is the standard veterinary surgical scissor. The Metzenbaum is a finer, lighter scissor in which the blade occupies approximately one quarter of the scissor length. Using a 14.5cm Metzenbaum rather than a 14cm Mayo will give you a finer scissor but a similar working distance.

Each style of scissor is available in four different versions which vary according to blade construction and cutting characteristics. They can be identified by handle colour.

- Standard: Stainless - silver-coloured throughout
- Supercut: Black handles
- Tungsten Carbide: Gold handles
- Supercut T.C.: One black handle, one gold handle

Surgical Scissor - Mayo



The Mayo is a general purpose surgical scissor.

745300	Mayo Chamf Blades Str 14cm 5.5"
745310	Mayo Chamf Blades Str 16.5cm 6.5"
745320	Mayo Chamf Blades Str 19cm 7.5"
745330	Mayo Chamf Blades Str 21.5cm 8.5"
745400	Mayo Chamf Blades Cof 14cm 5.5"
745410	Mayo Chamf Blades Cof 16.5cm 6.5"
745420	Mayo Chamf Blades Cof 19cm 7.5"
745430	Mayo Chamf Blades Cof 21.5cm 8.5"

Surgical Scissor - Metzenbaum



The Metzenbaum is a finer lighter scissor than the mayo.

746100	Metzenbaum Scissor Str 14.5cm 5.75"
746101	Metzenbaum Scissor Str 15cm 6"
746110	Metzenbaum Scissor Str 18cm 7"
746115	Metzenbaum Scissor Str 20.5cm 8"
746130	Metzenbaum Scissor Str 23cm 9"
746200	Metzenbaum Scissor Cof 14.5cm 5.75"
746210	Metzenbaum Scissor Cof 18cm 7"
746215	Metzenbaum Scissor Cof 20.5cm 8"
746230	Metzenbaum Scissor Cof 23cm 9"

Surgical Scissor - Supercut



One blade is sharpened to a tapered edge which greatly enhances the ability of the scissor to slice through tissues. The standard scissor has much more of a crushing action. Identified by having black handles.

760000	Mayo Supercut Str 14cm 5.5"
760002	Mayo Supercut Cof 14cm 5.5"
760008	Metzenbaum Supercut Str 14.5cm 5.75"
760009	Metzenbaum Supercut Cof 14.5cm 5.75"
760010	Metzenbaum Supercut Str 18cm 7"
760012	Metzenbaum Supercut Cof 18cm 7"

Surgical Scissors - Tungsten Carbide



Tungsten carbide cutting edges give long service life between sharpening. Gold handles distinguish these from standard scissors.

752250	Mayo Clinical Hard Edge Str 15cm 6"
752260	Mayo Clinical Hard Edge Str 18cm 7"
752280	Mayo Clinical Hard Edge Cof 15cm 6"
752290	Mayo Clinical Hard Edge Cof 18cm 7"
754020	Metzenbaum Hard Edge Str 14.5cm 5.75"
754030	Metzenbaum Hard Edge Str 18cm 7"
754060	Metzenbaum Hard Edge Str 23cm 9"
754080	Metzenbaum Hard Edge Cof 14.5cm 5.75"
754090	Metzenbaum Hard Edge Cof 18cm 7"
754120	Metzenbaum Hard Edge Cof 23cm 9"
754050	Metzenbaum Fino TC Cof 22cm 8.5"
754095	Metzenbaum Hard Edge Cof 35cm 14"

Surgical Scissor - Supercut T.C.



Combining the hard wearing characteristics of tungsten carbide with supercut tapered edges to provide a very fine cut and long interval between sharpening.

- 760000TC** Mayo Supercut T.C. Str 14cm 5.5"
- 760002TC** Mayo Supercut T.C. Cof 14cm 5.5"
- 760008TC** Metzenbaum Supercut T.C. Str 14.5cm 5.75"
- 760009TC** Metzenbaum Supercut T.C. Cof 14.5cm 5.75"
- 760010TC** Metzenbaum Supercut T.C. Str 18cm 7"
- 760012TC** Metzenbaum Supercut T.C. Cof 18cm 7"
- 760014TC** Metzenbaum Supercut T.C. Cof Fine 18cm 7"

Cosmetic Surgeon Scissors



Favoured by human cosmetic surgeons, these scissors have very fine razor-sharp blades with tungsten carbide inserts for long life. They have a beautiful action and a place in veterinary surgery where precise cutting is required, especially for fine skin.

- 755100** Cosmetic Surgeon Scissors T.C. Str 15cm 6"

General Scissors

Dressing - Blunt/Blunt



- 742610** Dressing Scissors Blunt Str 12.5cm 5"
- 742620** Dressing Scissors Blunt Str 14cm 5.5"
- 742630** Dressing Scissors Blunt Str 15cm 6"
- 742640** Dressing Scissors Blunt Str 18cm 7"
- 742900** Dressing Scissors Blunt Cof 12.5cm 5"
- 742622** Dressing Scissors Blunt Cof 14cm 5" Serrated
- 742910** Dressing Scissors Blunt Cof 14cm 5.5"
- 742920** Dressing Scissors Blunt Cof 15cm 6"
- 742930** Dressing Scissors Blunt Cof 18cm 7"

Dressing - Blunt/Blunt Coloured Handles



These standard dressing scissors are available with different coloured handles for easy identification.

- 742622G** Dressing Scissors Serr B/B Cof Gold Handles 12.5cm 5"
- 742622B** Dressing Scissors Serr B/B Cof Blue Handles 12.5cm 5"
- 742622RB** Dressing Scissors Serr B/B Cof Rainbow Handles 12.5cm 5"
- 742622P** Dressing Scissors Serr B/B Cof Purple Handles 12.5cm 5"



- 742625RB** Dressing Scissors Serr B/B Cof Rainbow 13cm 5"

Dressing - Sharp/Sharp



- 742600** Dressing Scissors Sharp Str 10cm 4"
- 742700** Dressing Scissors Sharp Str 11cm 4.5"
- 742710** Dressing Scissors Sharp Str 13cm 5"
- 742720** Dressing Scissors Sharp Str 14cm 5.5"
- 742730** Dressing Scissors Sharp Str 15cm 6"
- 742740** Dressing Scissors Sharp Str 18cm 7"
- 743010** Dressing Scissors Sharp Cof 12.5cm 5"

Dressing - Blunt/Sharp



- 742810** Dressing Scissors Blunt/Sharp Str 12.5cm 5"
- 742820** Dressing Scissors Blunt/Sharp Str 15cm 6"
- 743100** Dressing Scissors Blunt/ Sharp Cof 12.5cm 5"
- 743120** Dressing Scissors Blunt/ Sharp Cof 15cm 6"

Bandage Scissors Veterinary Bandage Scissors



Lower profile and slightly straighter than standard Lister bandage scissors, to better fit veterinary patients. Listers are often too bulky, as they are designed for larger human patients.

- 744820 Veterinary Bandage Scissors 14cm 5.5"
- 744830 Veterinary Bandage Scissors 19cm 7.5"

Lister Bandage



- 744800 Lister Bandage Scissor 14.5cm 5.5"
- 744810 Lister Bandage Scissor 18cm 7"

General Purpose Dressing Scissors



The comfortable handles and serrated blades make these a useful all round dressing scissor inexpensive enough for each consulting room.

- 744840 General Purpose Dressing Scissors 19cm 7.5"

Stitch Cutters Heath Stitch



General purpose stitch cutter.

- 743800 Heath Stitch Scissors 15cm 6"

Littauer Stitch



Very nice for removal of small awkward sutures.

- 745095 Littauer Stitch Scissors 9cm 3.5"
- 745100 Littauer Stitch Scissors 11cm 4.5"
- 745110 Littauer Stitch Scissors 12.5cm 5"

Castroviejo Suture Removal Scissors



Designed for the removal of very fine sutures. The Castroviejo action matches that of the Castroviejo Needle Holders.

- 014185 Castroviejo Suture Removal Scissors 12cm 4.5"

Needle Holders

Dedicated needleholders offer the best grip, and dedicated suture scissors offer the best cutting action. However combined needleholder/scissors are very popular for convenience in spite of the functional compromise. Most Vi needleholders are available with tungsten carbide jaw inserts. These grip and wear better. Particularly useful for smaller needles. Identified by gold handles.

Olsen Hegar Scissor/Needle Holder



Olsen Hegars are usually considered the 'go to' choice for general surgery. Highly recommended. Combined scissor/needle holder.

585400	Olsen Hegar Needle Holders 14cm 5.5"
585410	Olsen Hegar Needle Holders 16.5cm 6.5"
585420	Olsen Hegar Needle Holders 19cm 7.5"
605340	Olsen Hegar Needle Holders T.C. Jaws 11.5cm 4.5"
605350	Olsen Hegar Needle Holders T.C. Jaws 14cm 5.5"
605350S	Olsen Hegar Needle Holders 'S' Cut T.C. Jaws 14.5cm 5.5"
605355	Olsen Hegar Needle Holders T.C. Jaws 16.5cm 6.5"
605380	Olsen Hegar Needle Holders 'S' Cut T.C. Jaws 16cm 6"
605385	Olsen Hegar Needle Holders 'S' Cut T.C. Jaws 18cm 7"
605390	Olsen Hegar Needle Holders 'S' Cut T.C. Jaws 19cm 7.5"
605360	Olsen Hegar Needle Holders T.C. Jaws 19cm 7.5"
605361	Olsen Hegar Needle Holders Razor Cut 14.5cm 5.5 "
605362	Olsen Hegar Needle Holders Razor Cut 17cm 6.5"

Mayo & Mayo Hegar



Veterinary general purpose needleholder, available in a wide range of sizes with or without tungsten carbide jaw inserts. Mayo Hegar is the TC variant of standard Mayo.

584750	Mayo Needle Holders 12.5cm 5"
584760	Mayo Needle Holders 14cm 5.5"
584780	Mayo Needle Holders 16.5cm 6.5"
584765	Mayo Needle Holders 18cm 7.0"
584820	Mayo Needle Holders 20cm 8"
604700	Mayo Hegar T.C. Jaws 12.5cm 5"
604705	Mayo Hegar T.C. Jaws 14cm 5.5"
604715	Mayo Hegar T.C. Jaws 16cm 6"
604715L	Mayo Hegar T.C. Jaws - Left Handed 16cm 6"
604720	Mayo Hegar T.C. Jaws 18.5cm 7"
604735	Mayo Hegar T.C. Jaws 20cm 8"
604740	Mayo Hegar T.C. Jaws 23cm 9"

DeBakey Needle Holders



Much lighter in construction than the Mayo Hegar. These needleholders are very useful for deep surgical procedures where there is limited space e.g. chest surgery.

602005	DeBakey Needle Holders T.C. Jaws 18cm 7"
602010	DeBakey Needle Holders T.C. Jaws 20cm 8"
602030	DeBakey Needle Holders T.C. Jaws 22.5cm 8.5"
602015	DeBakey Needle Holders T.C. Jaws 23cm 9"
602020	DeBakey Needle Holders T.C. Jaws 25cm 10"
602025	DeBakey Needle Holders T.C. Jaws 30.5cm 12"

McPhails



The McPhails needle holder has one soft copper jaw for extra needle grip, the other is stainless steel. The catch engages with a moderate squeeze on the handles. Further pressure releases the catch and the needle.

584650	McPhails Needle Holders 15cm 6"
584660	McPhails Needle Holders 18cm 7"
584670	McPhails Needle Holders 20cm 8"

Gillies



Combined scissor/needle holder. No ratchet.

582950	Gillies Needle Holders RH 16cm 6.25"
582951	Gillies Needle Holders LH 16cm 6.25"
602950	Gillies Needle Holders T.C. Jaws RH 16cm 6.25"
602951	Gillies Needle Holders T.C. Jaws LH 16cm 6.25"

Foster Gillies



Smaller than the standard Gillies this instrument is useful for finer surgery or smaller hands.

- 582650 Foster Gillies Needle Holders RH 12.5cm 5"
- 602700 Foster Gillies Needle Holders T.C. Jaws RH 12.5cm 5"
- 602705 Foster Gillies Needle Holders T.C. Jaws LH 12.5cm 5"

Miniature Foster Gillies



- 602710 Miniature Foster Gillies T.C. 10cm 4"

Castroviejo



Classic ophthalmic needleholder with catch. Infrequent ophthalmic surgeons should also consider Miniature Fosters or Ryders as the squeeze action of Castroviejoes requires patience and practice to master. Also available without catch.

- 014175 Castroviejo Needle Holders With Catch T.C. 15cm 6"
- 014177 Castroviejo Needle Holders Without Catch T.C. 15cm 6"

Castroviejo Needle Holders/Scissor



This Instrument functions as a standard Castroviejo needleholder but the jaws incorporate a suture cutting function in the style of Olsen Hegars or Gillies. Jaws are tungsten carbide for maximum grip.

- 014181 Castroviejo Needle Holders/Scissor Str T.C. 15cm 6"
- 014182 Castroviejo Needle Holders/Scissor Cof T.C. 15cm 6"
- 014183 Castroviejo Needle Holders/Scissor Str 'S'Cut T.C. 15cm 6"
- 014184 Castroviejo Needle Holders/Scissor Cof 'S'Cut T.C. 15cm 6"

Kilner Needle Holders



Kilner needle holders are similar to 140mm Mayos but the arms are cranked, offsetting the jaws from the handles by around 10mm.

- 608000 Kilner Needle Holders 14cm 5.5"

Ryder Needle Holders



Ideal for small needles. The smaller sizes are an alternative for ophthalmic needleholders.

- 606340 Ryder (Micro) T.C. Jaws 12.5cm 5"
- 606345 Ryder (Micro) T.C. Jaws 15cm 6"
- 606350 Ryder (Micro) T.C. Jaws 18cm 7"

Derf Needle Holder



The Derf needle holder is a small T.C. needleholder with slightly heavier jaws than the Ryder. More resistant to surgeon abuse!

- 607010 Derf Needle Holder T.C. Jaws 12cm 5"

Galibans Suture Forceps



Use when placing sutures under tension. A good example is the placement of a lateral stabilising suture in the management of cranial cruciate ligament failure or abdominal sutures in an overweight dog. Galibans used by an assistant are used to atraumatically secure the first throw. The Galibans are removed as the second throw is tightened.

- 58900 Galibans Suture Holding Forceps

Towel Clips

Backhaus Towel Clip



- 841350 Backhaus 9cm 3.5"
 841355 Backhaus 10cm 4"
 841360 Backhaus 12.5cm 5"

Cross Action Towel Clips



- 846550 Shardel Cross Action 9cm 3.5"



- 171566 Jones Cross Action 9cm 3.5"

Atraumatic Towel Clip



Non puncturing but will bruise if not used with care

- 841352 Atraumatic Towel Clip 10cm 4.5"

Ball & Socket Towel Clamp



Designed for use on drapes only, for drape to drape anchorage. Less likely to cause tears, particularly with disposable drapes.

- 843005 Ball & Socket Towel Clamp 12.5cm 5"

Dissecting Forceps

Serrated Block End



General purpose dissecting forcep.

- 341070 Block End Serrated Dissecting Forceps 12.5cm 5"
 341075 Block End Serrated Dissecting Forceps 15cm 6"
 341080 Block End Serrated Dissecting Forceps 18cm 7"
 347655 Dressing Forceps 20.5cm 8"

Treves Rat Tooth Forceps



General purpose rat tooth dissecting forceps.

- 346850 Treves Dissecting Forceps 1/2 Teeth 12.5cm 5"
 346855 Treves Dissecting Forceps 1/2 Teeth 15cm 6"
 346860 Treves Dissecting Forceps 1/2 Teeth 18cm 7"
 347665 Fine Rat Tooth Thumb Forceps 20.5cm 8"

Dissecting Forceps 1/2 Teeth



- 341145 Dissecting Forceps 1/2 Teeth 15cm 6"
 341160 Dissecting Forceps 1/2 Teeth 18cm 7"
 341170 Lanes Dissecting Forceps 1/2 Teeth 6" 15cm
 349520 Lanes Dissecting Forceps 2/3 Teeth 7" 18cm

Connective Tissue Forceps



DeBakey-style handles with Adson Brown tips, providing excellent grip of connective tissue with minimal trauma.

- 343001 Connective Tissue Forceps 15.3cm 6"
 343002 Connective Tissue Forceps 18cm 7"

Adson



Ideal for fine surgical procedures. Available in a range of jaw designs.

341200	Adson Serrated Dissecting Forceps 12.5cm 5"
341201	Adson Serrated Extra Fine 12.5cm 5"
341210	Adson Dissecting Forceps 1/2 Teeth 12.5cm 5"
341212	Adson Brown Dissecting Forceps 12.5cm 5"
341214	Adson Brown Serrated/ Crocodile 15cm 6"
341215	Adson Brown 1/2 Teeth 15cm 6"
341220	Adson DeBakey Dissecting Forceps 12.5cm 5"

DeBakey - Atraumatic



Originally designed for cardiovascular surgery, these forceps grip firmly with minimal damage to delicate tissue, including bowel and urogenital system.

342005	DeBakey Dissecting Forceps 15cm 6"
342010	DeBakey Dissecting Forceps 18cm 7"
342020	DeBakey Dissecting Forceps 20.5cm 8.2"
342030	DeBakey Dissecting Forceps Angled 15cm 6"
342040	DeBakey Dissecting Forceps 24cm 9.4"

Epilation Forceps



342450	Epilation Forceps Square Jaws Plain 9cm 3.5"
---------------	--

St. Martin Dissecting Forceps



A very fine rat tooth for delicate procedures including corneal surgery.

014160	St. Martin Dissecting Forceps Teeth 9cm 3.5"
---------------	--

Retractors

Good retraction is the key to success in many procedures, especially surgery on deep structures e.g. the pelvis or the larynx.

Langenbeck Retractor



684375	Langenbeck Retractor 6mm Blade 21.5cm 8.5"
684395	Langenbeck Retractor Long Reach 6mm x 35mm Blade 21.5cm 8.5"
684380	Langenbeck Retractor 13mm Blade 21.5cm 8.5"
684390	Langenbeck Retractor 20mm Blade 21.5cm 8.5"
684385	Langenbeck Retractor 25mm Blade 21.5cm 8.5"

Morris Retractor



Much wider than the Langenbeck, good for fat abdomens.

684750	Morris Retractor 38mm 1.5" 21.5cm 8.5"
684755	Morris Retractor 50mm 2" 26cm 10"
684760	Morris Retractor 65mm 2.5" 22cm 8.5"

Senn (Cats Paw) Retractor



833305	Senn Retractor Sharp (Cats Paw) 16cm 6"
833310	Senn Retractor Blunt (Cats Paw) 16cm 6"

Fat Pad Retractor



Visualisation of the medial meniscus is maximised by retraction of the fat pad. Previously this has been achieved by use of a Senn (Cats Paw) retractor. The fat pad retractor has the same clawed foot but has a much more practical means of holding the instrument.

001114	Fat Pad Retractor 3 prong 18cm 7"
001114S	Fat Pad Retractor 2 prong Small 18cm 7"

Malleable (Walton) Retractors



These flat plates of soft stainless steel are bent intra-operatively to retain abdominal structures.

- 687613 Walton Retractor 13mm wide 175mm Long
- 687825 Walton Retractor 25mm wide 250mm Long
- 687651 Walton Retractor 50mm wide 330mm Long

Collins Retractor



The two blades swivel as retraction takes place. They self-centre in the incision.

- 703260 Collins Retractor 110mm Spread

Finochietto Rib Retractor



Finochietto is the standard rib retractor; available in large and small.

- 704000 Rib Retractor Finochietto Small 95mm Spread
- 704005 Rib Retractor Finochietto Large 130mm Spread

Gosset Retractor



Good as a rib retractor, laparotomy retractor and for retraction of ventral cervical structures during cervical fenestration.

- 701550 Gosset Retractor Large 185mm Spread
- 710600 Gosset Retractor Small 100mm Spread

Balfour Retractor

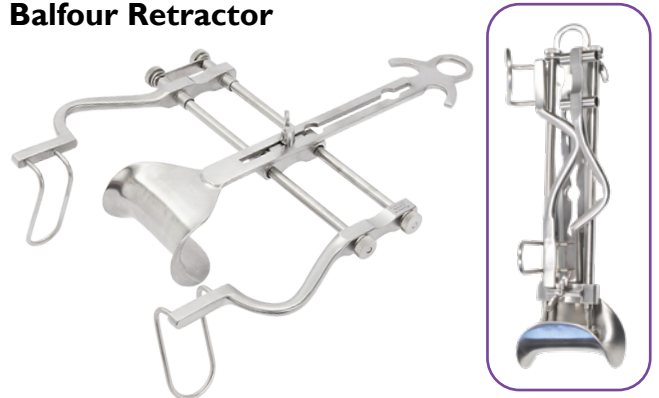

The original Balfour has for many years served as the standard large abdominal retractor for canine surgery. However the standard midline canine approach is very different from the standard human approach. Alasdair Hotston Moore has re-visited the original design and has made some significant changes which improve the instrument both in use and sterilisation.

The central blade in the Balfour slides freely on the back bar and automatically self-centers. If the lesion or organ of interest is off-centre this is undesirable. The Balfour locking ring fits onto the back bar and may be locked in any position, holding the blade off centre. The Balfour locking ring fits all Vi Balfours.

- 25-2375AHM AHM Balfour Retractor 180mm Spread
- 25-2375 Standard Balfour Retractor 180mm Spread
- 25-2377 Medium Balfour 115mm Spread
- 25-2376 Baby Balfour Retractor 90mm Spread
- 25-2375R Balfour Locking Ring

Ring Retractor

Some abdominal approaches require a more complex retraction system than a simple Balfour or Gossett. The Vi Ring Retractor allows the surgeon to place hooked retractor strips around the periphery of a surgical incision which may then be tensioned individually and retained around the edge of the ring.

The ring is laser cut from stainless steel which is thin enough to mould to the profile of the patient. Slots are cut every 15mm around the periphery of the ring into which lock one or more retractor strips.

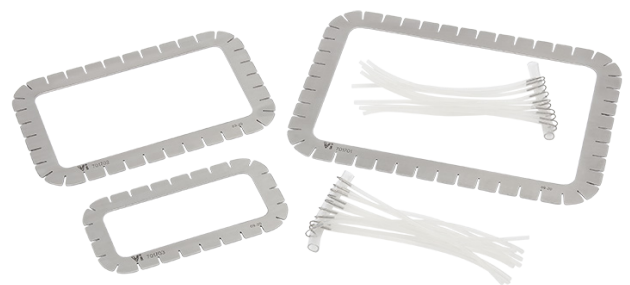

The strips are manufactured from silicone with a stainless hook. The strips are autoclavable but will require periodic replacement.

All the rings fit into standard counter-top autoclaves.

Please note: Vi Sterile Hooks are compatible with other retractor systems.

- 701700 Ring Retractor Set - S, M, L Rings With 10 Sterile Hooks
- 701701 Large Ring 200 x 130mm Internal
- 701702 Medium Ring 160 x 85mm Internal
- 701703 Small Ring 110 x 40mm Internal
- 701HOOK-A Set of 10 Sterile Hooks

Travers Retractor



Useful for retraction of skin and superficial soft tissue.

- 703051 Travers Self Retaining Retractor 70mm Spread 16.5cm 6.5"
- 703050 Travers Self Retaining Retractor 90mm Spread 20cm 8"
- 703053 Travers Self Retaining Retractor Mini 43mm Spread 9.5cm

Weislander Retractor



Arms are flat compared with the Wests. Proportions differ from Travers.

- 702150 Weislander Self Retaining Retractor Sharp 60mm Gape 14cm 5.5"
- 702152 Weislander Self Retaining Retractor Blunt 60mm Gape 14cm 5.5"

West Retractor



Widely used but sharp points tend to snag tissues. Curved arms sit quite nicely on small veterinary patients.

- 703250 West Retractor 50mm Spread 14cm 5.5"
- 703253 West Retractor 40mm Spread 9.5cm 4"

Gelpi Self Retaining Retractor



The Gelpi is an extremely versatile self retaining retractor useful in almost any orthopaedic procedure. Veterinary Instrumentation Gelpis are different from standard Gelpis in two respects:

1. Short blunt tips give focal retraction for precise exposure of the fracture or lesion
2. The teeth on the ratchet are smaller than usual giving finer control over the spread of the tips

Gelpis are virtually an extra pair of hands and are invaluable where the surgeon is working without a scrubbed assistant. The curved shape fits nicely on our patients.

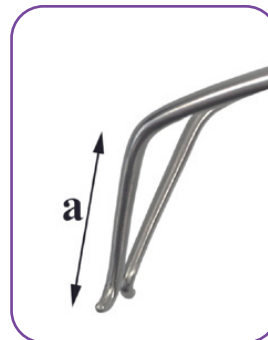

Two pairs of Gelpis placed at right angles to one another may be used to create a window into a joint or fracture site. Gelpis are available in a number of lengths. Measurement 'a' gives the depth of the tips.

Available as singles or sets of two Gelpis.

- 001330 Gelpi Retractor 120mm Spread (a=20mm) 180mm Long
- 001330SL Gelpi Retractor With Spinlock (a=20mm) 180mm Long
- 001330S Gelpi Retractor Sharp Tips (a=20mm) 180mm Long
- 001331 Gelpi Long Reach (a=40mm) 200mm Long
- 001331L Gelpi Very Long Reach (a=60mm) 200mm Long
- 001332 Gelpi Small 60mm Spread (a=15mm) 135mm Long
- 0013301 Gelpi Mini Flat 45mm Spread (a=15mm) 90mm Long
- 0013302 Gelpi Mini Curved 45mm Spread (a=15mm) 90mm Long
- 0013303 Gelpi Mini Curved 45mm Spread Blunt Tips 90mm Long



- 001330/2 Gelpi Retractors 120mm Spread (a=20mm) 180m Long Set Of 2
- 001330SL/2 Gelpi Retractors With Spinlock(a=20mm) 180mm Long Set Of 2
- 001330S/2 Gelpi Retractors Sharp Tips (a=20mm) 180mm Long Set Of 2
- 001331/2 Gelpi Long Reach (a=40mm) 200mm Long - Set Of 2
- 001331L/2 Gelpi Very Long Reach (a=60mm) 200mm Long - Set Of 2
- 001332/2 Gelpi Small 60mm Spread (a=15mm) 135mm Long - Set Of 2
- 0013301/2 Gelpi Mini Flat 45mm Spread (a=15mm) 90mm Long - Set Of 2
- 0013302/2 Gelpi Mini Curved 45mm Spread (a=15mm) 90mm Long - Set Of 2
- 0013303/2 Gelpi Mini Curved 45mm Spread 90mm Long Blunt Tips - Set Of 2
- 001333 Gelpi Self Retaining Retractors Odd Leg 205mm Pair

Bungee Gelpi Self Retaining Retractors

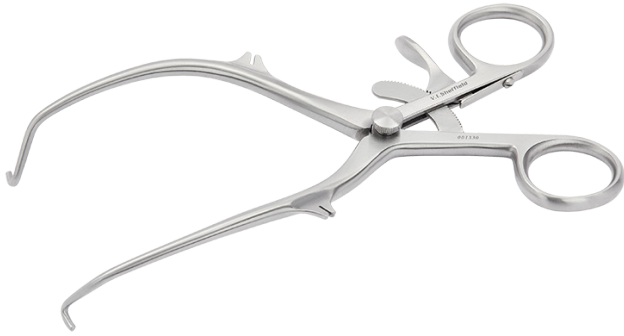

Based on the Vi standard Gelpi, with added anchor points for elastic stays allowing 4 point retraction from a single two point instrument. Anchor points may be double loaded for 6 point retraction. Accepts Vi Sterile Hooks.

Advantages:

- Better retraction with fewer retractors cluttering a wound
- Greater stability of Gelpi's within a wound with four or six point retraction preventing the tips from sliding towards each other. Easier for surgeries which are often performed in a more vertical position, such as perineal hernia repair
- More useful shape to retracted hole – more rectangular than round, square or diamond, but is very adaptable to suit the situation
- Multi-layer retraction such as creating deep retraction with tips and improved skin retraction with the elastic stays

001330BUNGEE Gelpi Bungee Retractor

701HOOK-A Set of 10 Sterile Hooks

Sterile Surgical Skin Marker

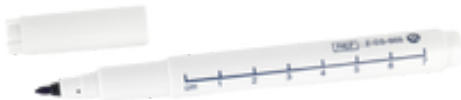

Supplied in a sterile peel pouch, the surgical marker allows the surgeon to demarcate selected sites prior to or during surgery. The marker is scrub resistant, non toxic and highly visible. Especially useful around the eyes and ears where accurate reconstruction is vital. Also useful for large skin reconstruction procedures.

001487 Surgical Skin Marker Single



Probes & Cutting Guides



Use the blunt probe to track fistulae. The butterfly cutting guide has a groove along its length to allow a scalpel to be run down without fear of damaging deeper tissues, the vulnerable tissues being protected by the guide. The notched spade end is useful for isolating vessels before ligating.

901010 Blunt Dissection Probe 140mm

901015 Winged Director 130mm

Cheatle Steriliser Forceps



For manipulation of instruments during setting up.

787655 Cheatle Steriliser Forceps 26.5cm 10.5"



ViPP

Through a true partnership approach, you can deliver quantifiable rewards for you and your Practice by joining our **Veterinary Instrumentation Partnership Programme**.

To find out more, scan the QR code below.



Left Handed Instruments

Vi offer a selection of left handed instruments, identified by one black handle.

Vi General Surgery Kit - Left Handed



The Vi General Surgery Left Handed Kit contains:

171566	Jones Cross Action Towel Clips	x4
746100L	Metzenbaum Scissors - Straight 145mm - Left Handed	x1
745300L	Mayo Scissors Chamf Blades 140mm - Left Handed	x1
341145	Dissecting Forceps 1/2 Teeth 150mm	x1
106625L	Spencer Wells Artery Forceps - Cvd 125mm - Left Handed	x2
106600L	Spencer Wells Artery Forceps - Str 125mm - Left Handed	x2
103175L	Halstead Mosquito Forceps 125mm Left Handed	x2
342005	Debakey Forceps 150mm	x1
341200	Adson Serrated Dissecting Forceps 125mm	x1
585400L	Olsen Hegar Needle Holders - Left Handed	x1
0803	Scalpel Handle No 3	x1

VIGSKIT-L Vi General Surgery Kit Left Handed

Left Handed Instrument Starter Kit



The Left Handed Instrument Starter Kit contains:

585400L	Olsen Hegar Needle Holders - Left Handed	x1
745300L	Mayo Scissors Str 140mm - Left Handed	x1
746200L	Metzenbaum Scissors Str 145mm - Left Handed	x1
746110L	Metzenbaum Scissors Str 180mm - Left Handed	x1
103175L	Halstead Forceps Str 125mm - Left Handed	x2
103225L	Halstead Forceps Cof 125mm - Left Handed	x2
101780L	Crile Forceps Cof 140mm - Left Handed	x4
841350L	Backhaus Towel Clips - Left Handed	x4
341210	Adson Serrated Dissecting Forceps 125mm	x1
342005	Debakey Forceps 150mm	x1
0803	Scalpel Handle No 3	x1
BX201040	Stainless Steel Box 200mm X 100mm X 40mm	x1

LHKIT Left Handed Instrument Starter Kit

Vi also offer Left Handed Spay Kits. See page 173 for further details.

Left Handed Mayo Scissors



745300L	Mayo Scissor Blunt/Blunt Straight LH 14cm 5.5"
745400L	Mayo Scissor Blunt/Blunt Curved LH 14cm 5.5"
745310L	Mayo Scissor Blunt/Blunt Straight LH 16.5cm 6.5"
745410L	Mayo Scissor Blunt/Blunt Curved LH 16.5cm 6.5"

Left Handed Lister Bandage Scissors



744800L	Lister Bandage Scissor LH 145mm 5.5"
744810L	Lister Bandage Scissor LH 18cm 7"

Left Handed Metzenbaum Scissors



746100L	Metzenbaum Scissor Blunt/Blunt Straight LH 14.5cm 5.75"
746101L	Metzenbaum Scissor Blunt/Blunt Straight LH 15cm 6"
746200L	Metzenbaum Scissor Blunt/Blunt Curved LH 14.5cm 5.75"
746110L	Metzenbaum Scissor Blunt/Blunt Straight LH 18cm 7"
746115L	Metzenbaum Scissor Blunt/Blunt Straight LH 20cm 8"

Left Handed Iris Scissors



744110L	Iris Scissor Round Straight LH 11.5cm 4.25"
744130L	Iris Scissor Round Curved LH 11.5cm 4.25"

Left Handed Dressing Scissors



742910L Dressing Scissors Blunt/Blunt Cvd LH 14.5cm 6"



014307L Carmalt Forceps Curved LH 20cm 8"

Left Handed Forceps



103175L Halsted Mosquito Artery Forcep Straight LH 12.5cm 5"
103225L Halsted Mosquito Artery Forcep Curved LH 12.5cm 5"
801155L Allis Tissue Forceps 3/4 Teeth 15cm 6"



841350L Backhaus Towel Clip LH 9cm 3.5"

Left Handed Needle Holders



101750L Crile Artery Forcep Straight LH 14cm 5.5"
101780L Crile Artery Forcep Curved LH 14cm 5.5"



604715L Mayo Hegar Needle Holder LH 16.5cm 6.5"
604720L Mayo Hegar Needle Holder LH 18.5cm 7"
585400L Olsen Hegar Needle Holder LH 14cm 5.5"
605355L Olsen Hegar Needle Holder LH 16.5cm 6.5"
585420L Olsen Hegar Needle Holder LH 18cm 7"

Left Handed Foster Gillies



106230L Rochester Pean Artery Forcep Straight LH 16cm 6.5"
106275L Rochester Pean Artery Forcep Curved LH 16cm 6.5"



582660 Foster Gillies Needle Holder LH 12.5cm 5"
602705 Foster Gillies Needle Holder LH TC Jaws 12.5cm 5"

Left Handed Gillies



106625L Spencer Wells Artery Forceps Curved LH 12.5cm 5"
106600L Spencer Wells Artery Forceps Straight LH 12.5cm 5"
106630L Spencer Wells Artery Forceps Curved LH 15cm 6"



582951 Gillies Needle Holder LH 16cm 6.25"
602951 Gillies Needle Holder LH TC Jaws 16cm 6.25"

Soft Tissue



To visit the Soft Tissue section of our website, please scan the QR code.



Ethicon Suture Range



See our Ethicon range in
Chapter 7 – General Surgical

pages 170-171

ETHICON

BOAS Mouth Gag

Patent number: GB2616493



The BOAS Mouth Gag from Vi has been developed specifically to aid surgeons performing BOAS surgery. The unique design allows vastly improved visualisation and surgical access during these procedures.

This device is based on the design of the ever-popular table-top gag for rabbit and rodent dentistry, with several key features and adaptation specifically intended for BOAS surgery.

Special design features include:

- Fully adjustable tilting base to support the upper body of the patient at the desired angle to maximise visualisation and access.
- The tilting base is supported by sturdy upright bars to ensure excellent stability and optimal weight capacity.
- Two adjustable horizontal bars to retain the patients' mouth open in the desired position. Both bars are adjustable up/down, and the upper bar also adjusts forwards/backwards.
- Silicone bar sleeves for the horizontal bars are available to minimise potential trauma to the patient's gums.
- Front-positioned cleat hook to allow tie-down of the tongue if desired.
- Supporting hook for the ET tube or anaesthetic circuit. This is height-adjustable and can be positioned to either the front or the side of the upright.

BOASMG	BOAS Surgery Mouth Gag Complete
BOASST	BOAS Silicone Bar Sleeve 190mm Long
BOASST-SML	BOAS Silicone Bar Sleeve - Small Bars
BOASBARS-SML	Small Bar Set for BOAS Mouth Gag c/w Silicone Sleeves

BOAS Surgical Kit



Vi supply a set of instruments suitable for BOAS and upper airway surgery. The BOAS Standard Surgical Kit contains:

014050	Soft Palate Clamps Internal 18x7mm	x1
014040	Soft Palate Clamps Internal 26x12mm	x1
760012	Metzenbaum Supercut Scissors 180mm Cvd	x1
801156	Allis Tissue Forceps 3/4 Teeth 180mm	x2
602010	DeBakey TC Needleholder 200mm	x1
342020	DeBakey Atraumatic Dissecting Forceps 205mm	x1
BX201470P-F	Premium Instrument Box 300x140x70mm w/ Filters	x1
PBX270125	Fingered Silicone Mat 270x125mm Green	x1

BOASSTDKIT BOAS Surgical Kit - Standard

BOAS Premium Kit

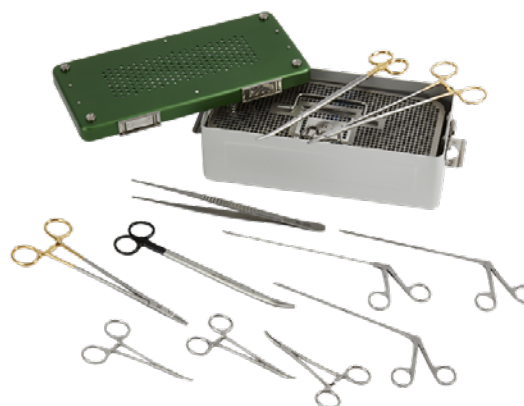

Vi supply a set of premium instruments suitable for BOAS and upper airway surgery. The BOAS Premium Surgical Kit contains:

103160	Mosquito Forceps XX Micro Curved	x1
014057	Fine Tubular Grasping Forceps 7in	x1
606355	Ryder TC Needle Holder Mini Profile Tip 4-230mm	x1
760020	Ligature Scissors Supercut 230mm	x1
754050	Metzenbaum Fino TC Blunt/Blunt 9"	x1
342040	DeBakey Atraumatic Dissecting Forceps 240mm	x1
014080	Micro Scissors Left Curve S/S Vertical Cut 175mm	x1
014081	Micro Scissors Right Curve S/S Vertical Cut 175mm	x1
602030	DeBakey Needleholder TC 225mm	x1
103225	Halstead Mosquito Artery Forceps 125mm CVD	x2
BX301410P-F	Premium Instrument Box 300x140x100mm W/ Filters	x1
PBBXINNERI	Perforated Tray with Lid 270x123x65mm	x1
PBBXRD2	Instrument Holding Pin for Wire Baskets	x4
PBBXRD1	Silicone Instrument Holders Open Top	x1

BOASPREMKIT BOAS Surgical Kit -Premium

Micro Scissors



014080	Micro Scissors Left Curve Vertical Cut S/S 175mm
014081	Micro Scissors Right Curve Vertical Cut S/S 175mm

Disposable Tracheostomy Tubes

014076	Tracheostomy Tube I/D 2.5mm O/D 4.0mm
014077	Tracheostomy Tube I/D 4.0mm O/D 6.0mm
014078	Tracheostomy Tube I/D 5.5mm O/D 8.0mm
014079	Tracheostomy Tube I/D 7.0mm O/D 10.0mm



Airway Surgery Soft Palate Clamp



An overlong palate is a common cause of dyspnoea in the brachiocephalic dog. Shortening the soft palate in an atraumatic manner provides almost immediate relief.

The soft palate clamp was designed by Geoff Lane FRCVS.

The jaws have a special atraumatic grip to hold the very slippery soft palate.

- 014040 Soft Palate Clamps Large 26 x 12mm 170mm Long
- 014050 Soft Palate Clamps Small 18 x 7mm 170mm Long

Tonsillectomy Clamp



The standard Negus clamp may be used in pairs for soft palate resection. A right angled version designed by Stephen Baines at the Willows is also available.

- 014038 Tonsillectomy Clamp Right Angle 190mm Long
- 014039 Tonsillectomy Clamp Curved 190mm Long

Negus Forceps



- 7018/05 Negus Artery Forceps Small Cof 18cm 7"

Satinsky Clamp



Useful for intra-thoracic surgery, trimming soft palates and even ears. Atraumatic design maximises haemostasis and minimises trauma.

- 2685/03 Satinsky Clamps 20mm Jaw 160mm Long
- 2685/05 Satinsky Clamps 30mm Jaw 200mm Long

Soft Tissue Biopsy Forceps



Designed to take samples of soft tissue masses from the ear or via the mouth, these forceps come in three sizes and will work in combination with standard aural specula.

Fits down all usual aural specula.

- 014087 Cup Biopsy Forceps 2mm Diameter Shaft 75 x 3.6mm
- 014087A Cup Biopsy Forceps 2mm Diameter Shaft 100 x 3.6mm
- 014088 Cup Biopsy Forceps 3.5 x 8mm Shaft 105 x 5.6mm

Angled Allis Tissue Forceps



This angled Allis has 4 into 5 teeth at the tip and is angled mid shaft. The kink in the shaft of the Allis allows use in the upper airway and pharynx without obstructing other instrumentation. Please note, at 20cm the length is longer than the standard Allis.

- 801161 Angled Allis Tissue Forceps 4/5 Teeth 20cm Long

Aural Surgery

Malleable Instrument Set



Fully flexible instruments are difficult to control. Malleable instruments allow the tips to be positioned exactly where the surgeon needs them. The malleable instrument set contains:

014098	Malleable Grasping Forceps 145mm Shaft	x1
014099	Malleable Biopsy Forceps 2mm Cup 145mm Shaft	x1
012528	Malleable Ear Loop Curette 2.0mm Diameter	x1
012529	Malleable Ear Loop Curette 4.0mm Diameter	x1

Stainless steel box with silicone insert.

014125 Malleable Instrument Set in Stainless Steel Case

Canine Ear Loop

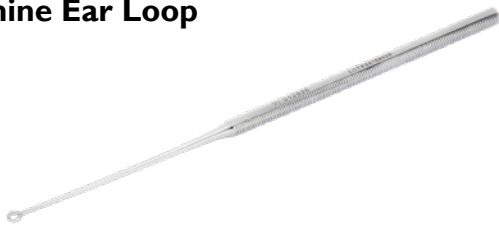

Removal of hard wax and other debris from the canine horizontal canal without causing trauma is a common problem in veterinary surgery.

It is now accepted that the use of ear loops is more effective than cotton tipped products. Most human ear loops are too large and too short for use with the much longer veterinary specula.

Vi's Canine Ear Loop is slimmer and longer to facilitate debris removal without obscuring the visual field. The flexible ear loop is very fine and flexible for added safety. The Buck ear loop is firmer.

012526	Canine Buck Looped Ear Curette
012528	Malleable Ear Curette Cats/Small Dogs
012529	Malleable Ear Curette Medium/Large

Malleable Grasping & Biopsy Forceps



The fine flexible grasping forceps have a maximum diameter of 1.7mm and are therefore ideal for small working channels and speculae. The forceps are available as graspers or as biopsy forceps.

014098	2mm Malleable Grasping Forceps 145mm
014099	2mm Malleable Biopsy Forceps 145mm

Crocodile Forceps

Removal of foreign bodies, particularly grass seeds, is achieved using long crocodile forceps. Available in traditional designs or as a fine tubular shaft design.



Extra Fine

014091	Extra Fine Crocodile Forceps Tubular 3" Shaft
014092	Extra Fine Crocodile Forceps Tubular 5" Shaft
014093	Extra Fine Crocodile Forceps Tubular 7" Shaft
014089	Extra Fine Crocodile Forceps Tubular 9" Shaft



Standard Jaw

014094	Aural Crocodile Forceps Standard Jaw 3" Shaft
014095	Aural Crocodile Forceps Standard Jaw 5" Shaft
014096	Aural Crocodile Forceps Standard Jaw 7" Shaft

TECA Retractor - Pieter Nelissen



Achieving adequate exposure is essential when performing lateral bulla osteotomy and debridement, especially in broad headed breeds, this will mean working down a narrow and surprisingly deep corridor.

Following the suggestion from Pieter Nelissen, we have developed a purpose made TECA Retractor. The 40mm long legs are at 80° to the handles to reach deep into the hole created. The cross-over tips are only 3mm across when closed enabling insertion with no edges protruding to snag tissues.

001338 TECA Retractor 105mm Long 40mm Cross-Over Legs

Bulla Rongeurs



142280 Bulla Rongeurs 200mm

Implants For Hart Pinna Haematoma System

014601U/S Fenestrated Implants Pack of 12 Supplied Unsterile

Thoracic Surgery

Thoracic Surgery Kit



Working inside the chest of medium and large dogs will require extended instrumentation. The instruments listed below represent a useful kit. In addition a pair of rib retractors will be required. Other useful instruments include extra long Metzenbaum scissors and right angled forceps (Lahey cholecystectomy clamp and small right angled forceps).

The Thoracic Surgery Kit contains:

106205	45 Degree Curved Forceps 220mm	x1
105415	90 Degree Curved Forceps 245mm	x1
754060	Metz Scissors Str 235mm T.C.	x1
754120	Metz Scissors Curved 235mm T.C.	x1
342020	DeBakey Thumb Forceps 205mm	x1
347665	Rat Tooth Thumb Forceps 205mm	x1
602010	Debakey Needleholders T.C. 200mm	x1
347655	Dressing Forceps 205mm	x1
2685/03	Satinsky Clamps 160mm Long 20mm Jaw	x1
2685/05	Satinsky Clamps 200mm Long 30mm Jaw	x1
BX281450	Instrument Box 280x140x50mm	x1

CAMTHORKIT Thoracic Surgery Kit

Finochietto Rib Retractors



Finochietto is the standard rib retractor, available in large and small.

704000	Rib Retractor Finochietto 95mm
704005	Rib Retractor Finochietto 130mm

Right Angled Clamps



Typically used to dissect around a patent ductus arteriosus and then pull through appropriate ligature material.

014051	Right Angled Lahey Cholecystectomy Clamps 195mm Long
014052	Small Right Angle Clamps 160mm Long
014052S	Small Right Angle Clamps Without Ratchet 160mm Long
014052M	Mixer Forceps With Ratchet 140mm Long
014052A	Right Angled Clamp With Ratchet 250mm

Curved Forceps - Long



106205 45 Degree Curved Forceps 220mm Long



105415 90 Degree Curved Forceps 235mm Long

Thoracic Surgery

Foreign Body Retrieval Forceps

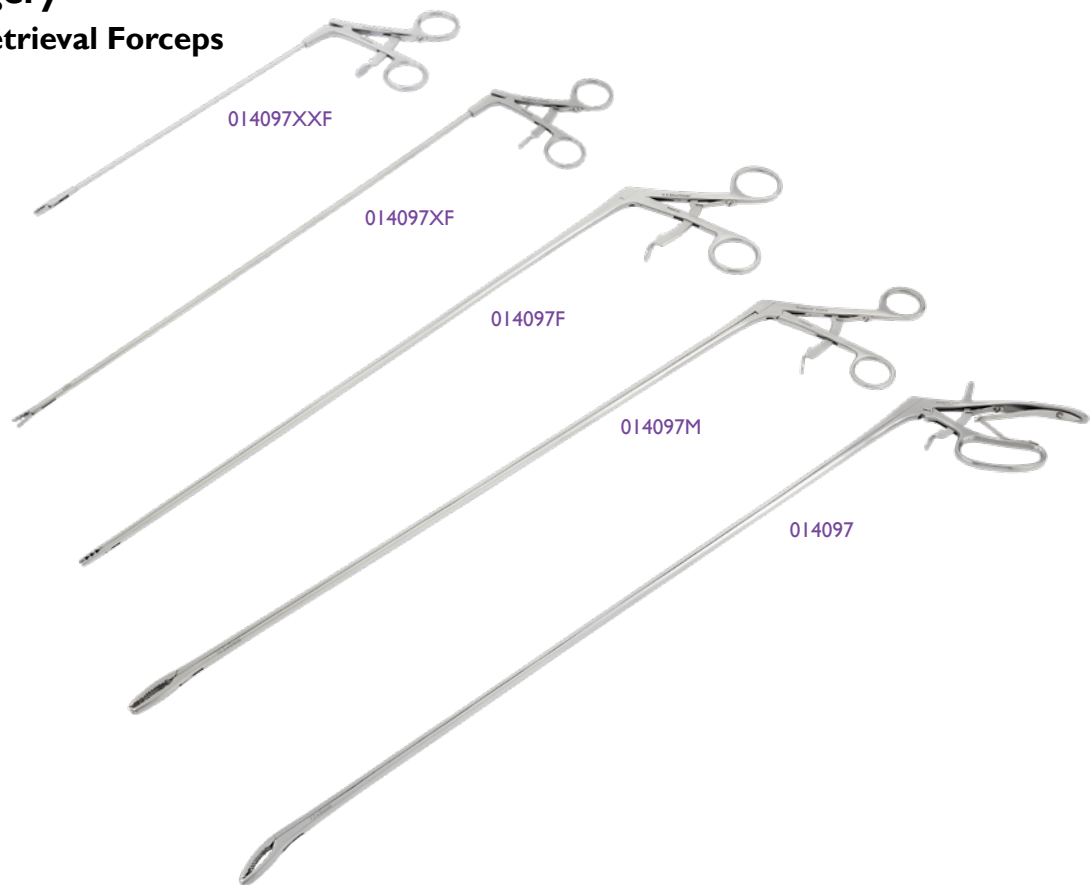

We offer a range of forceps to cover every eventuality from a bone in the oesophagus of a large dog to a grass seed in a cat trachea.





The forceps may be guided by rigid or flexible endoscopes or fluoroscopy. In exceptional cases retrieval may be achieved by 'feel'.

The teeth on these forceps face backwards for maximum grip. When closed the jaws are atraumatic for minimal damage to the oesophagus or trachea. It is helpful to inflate the oesophagus prior to withdrawal of spiky objects.

Key Features:

- Backward-facing teeth for maximum grip
- Jaws are externally atraumatic
- Shaft diameter as small as possible
- Large forceps jaws are angled when closed so that when open they sit mid-oesophagus

014097	Foreign Body Retrieval Forceps	640mm Shaft Length
014097M	Foreign Body Retrieval Forceps	500mm Shaft Length
014097F	Foreign Body Retrieval Forceps	400mm Shaft Length
014097XF	Foreign Body Retrieval Forceps	400mm Shaft Length
014097XXF	Foreign Body Retrieval Forceps	220mm Shaft Length

Code		Diameter at Jaws in mm	Length at Jaws in mm	Shaft Diameter in mm	Shaft Length in mm
014097		16 x 8	37	8.5 x 7	640
014097M		11.5 x 6	31	6 x 8	500
014097F		6 x 4.2	14.5	6 x 4.2	400
014097XF		4.5	1.5	4.5	400
014097XXF		4	9	3	220

Ovariohysterectomy Feline Spay Kit



The Feline Spay Kit contains:

585400	Olsen Hegar Needleholders 140mm Long	x1
746100	Metzenbaum Scissors Straight 145mm Long	x1
106625	Spencer Wells Artery Forceps Curved 125mm Long	x2
103225	Halstead Mosquito Forceps Curved 125mm Long	x2
014211	Spay Forceps 125mm Long	x1
341210	Adson Dissecting Forceps 1/2 Teeth 125mm Long	x1
171566	Jones Cross Action Towel Clips 90mm Long	x2
0803	Scalpel Handle No.3	x1
BX201040	Stainless Steel Instrument Box	x1

SPAYFEL Cased Feline Spay Kit

Alternative Feline Spay Kit



The Alternative Feline Spay Kit contains:

585400	Olsen Hegar Needleholders 140mm Long	x1
746101	Metzenbaum Scissors Straight 150mm Long	x1
106625	Spencer Wells Artery Forceps Curved 125mm Long	x3
103225	Halstead Mosquito Forceps Curved 125mm Long	x3
014211	Spay Forceps 125mm Long	x1
341210	Adson Dissecting Forceps 1/2 Teeth 125mm Long	x1
171566	Jones Cross Action Towel Clips 90mm Long	x2
0803	Scalpel Handle No.3	x1
801150	Allis Tissue Forceps 2/3 Teeth 150mm	x1

SPAYFEL-V2 Feline Spay Kit V2

Canine Spay Kit



The Canine Spay Kit contains:

585410	Olsen Hegar Needleholders 165mm Long	x1
745300	Mayo Chamf Blades Straight 140mm Long	x1
106630	Spencer Wells Artery Forceps Curved 150mm Long	x4
014307	Carmalt Forceps Curved 200mm Long	x2
801155	Allis Tissue Forceps 3/4 Teeth 150mm Long	x2
341145	Dissecting Forceps 1/2 Teeth 150mm Long	x1
171566	Jones Cross Action Towel Clips 90mm Long	x4
0803	Scalpel Handle No.3	x1
BX221550	Stainless Steel Instrument Box	x1
BXSIL2215	Silicone Insert	x1

SPAYCAN Cased Canine Spay Kit

Alternative Canine Spay Kit



The Alternative Canine Spay Kit contains:

585410	Olsen Hegar Needleholders 165mm Long	x1
745300	Mayo Chamf Blades Straight 140mm Long	x1
106630	Spencer Wells Artery Forceps Curved 150mm Long	x4
014307	Carmalt Forceps Curved 200mm Long	x2
801155	Allis Tissue Forceps 3/4 Teeth 150mm Long	x2
341145	Dissecting Forceps 1/2 Teeth 150mm Long	x1
171566	Jones Cross Action Towel Clips 90mm Long	x4
0803	Scalpel Handle No.3	x1
106605	Spencer Wells Artery Forceps 150mm Str	x4

SPAYCAN-V2 Canine Spay Kit V2

Left Handed Spay Kits

The full contents for Vi's Left Handed Spay Kits can be found on page 175.

SPAYFEL-L Cased Feline Spay Kit Left Handed

SPAYCAN-L Cased Canine Spay Kit Left Handed

Spay Hooks



Use to atraumatically lift uterine horns.

014320 Spay Hook Small 130mm Long

014325 Spay Hook Large 170mm Long

Spay Forceps



Atraumatic spay forceps-tips have fine toothed DeBakey type form.

014211 Spay Forceps 125mm Long

014218 Spay Forceps (DeBakey Type) 125mm Long

Angiotribes



The jaws of this instrument are designed for maximum crushing by serrated longitudinal grooves.

014304 Angiotribes Straight 160mm

014305 Angiotribes Curved 160mm

014301 Angiotribes Straight 200mm

014302 Angiotribes Curved 200mm

Hysterectomy Clamps (Carmault)



These clamps are curved with longitudinal grooves in the jaws to minimise tissue slippage.

- 014307 Hysterectomy Clamp (Carmault) 200mm Long
- 014309 Hysterectomy Clamp (Carmault) 160mm Long
- 014307L Carmault Forceps Curved LH 200mm

Howard 'B' Ovariohysterectomy Clamp



Designed and developed in practice by Howard Taylor who recognised that ovariohysterectomy was far from straightforward, particularly but not exclusively for recent graduates.

The clamp has a number of features which assist the surgeon in the exposure and ligation of the ovarian pedicle.

- The ligature material is preloaded onto the forceps which takes it through the broad ligament
- Longitudinal grooves in the jaw minimise slippage
- As the forceps are rotated the 'B' shaped extension 'collects' and brings together the structures of the pedicle ready for tying
- The forceps sit outside the incision to exteriorise the pedicle
- The ligature is tied without precrushing but is retained by a small haemostat to check for bleeding prior to closure

- 546470 Howard 'B' Ovariohysterectomy Clamp 160mm Long

Hauptman Retractors



This retractor designed by Joe Hauptman maintains distal retraction of the ovary during ligation of the ovarian pedicle. This is the crucial part of the procedure which can be a challenge for even experienced surgeons.

- 014400 Small Hauptman Retractor 10mm Blade
- 014410 Medium Hauptman Retractor 15mm Blade
- 014420 Large Hauptman Retractor 20mm Blade

Obstetrical Items



- 546465 Hobdays Obstetric Forceps for Cats 150mm Long
- 546466 Hobdays Obstetric Forceps for Dogs 210mm Long



- 546455 Killian Bitch Speculum Blade Length 650mm Long (2½")

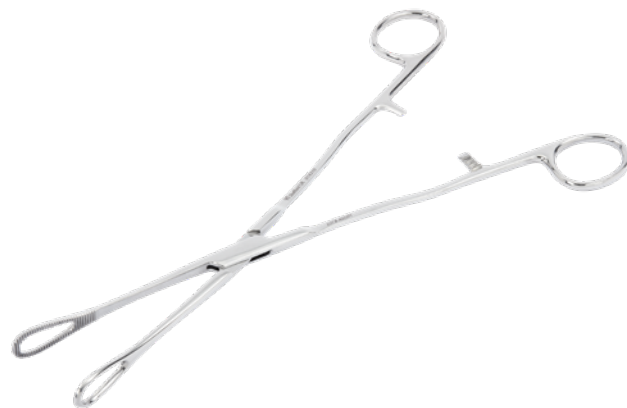

- 014310 Whelping Forceps 260mm Long

Abdominal Surgery

Vascular Probe Set



A set of 15 vascular probes in a fully autoclavable stainless steel case. The 25mm long angled working tips are of specified diameter permitting accurate documentation of blood vessel diameter and marriage of blood vessel diameters when performing vascular anastomoses. With an overall length of 225mm, these are especially useful in abdominal surgery, in particular for documenting hepatic shunts.

The set includes probe diameters of 1.25mm, 1.5mm, 1.75mm, 2mm, 2.25mm, 2.5mm, 2.75mm, 3mm, 3.25mm, 3.5mm, 3.75mm, 4mm, 4.5mm, 5mm and 6mm. Diameters are clearly etched on the handles.

0014SET Vascular Probe Set

Balfour Retractors

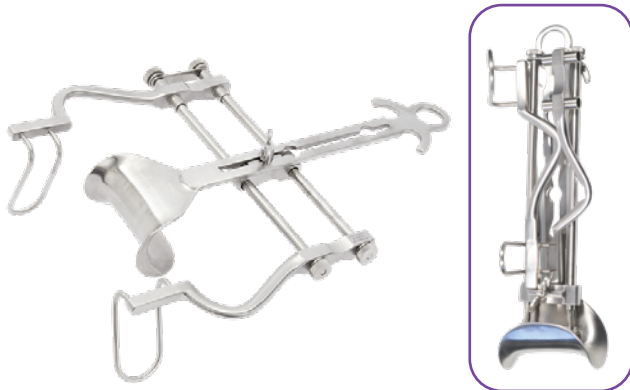

The original Balfour has for many years served as the standard large abdominal retractor for canine surgery. However the standard midline canine approach is very different from the standard human approach. Alasdair Hotston Moore has re-visited the original design and has made some significant changes which improve the instrument both in use and sterilisation.

25-2375AHM AHM Balfour Retractor 180mm Spread
25-2375 Standard Balfour Retractor 180mm Spread
25-2377 Medium Balfour 115mm Spread
25-2376 Baby Balfour Retractor 90mm Spread
25-2375R Balfour Locking Ring

Ring Retractor

Some abdominal approaches require a more complex retraction system than a simple Balfour or Gossett. The Vi Ring Retractor allows the surgeon to place hooked retractor strips around the periphery of a surgical incision which may then be tensioned individually and retained around the edge of the ring.

The ring is laser cut from stainless steel which is thin enough to mould to the profile of the patient. Slots are cut every 15mm around the periphery of the ring into which lock one or more retractor strips.

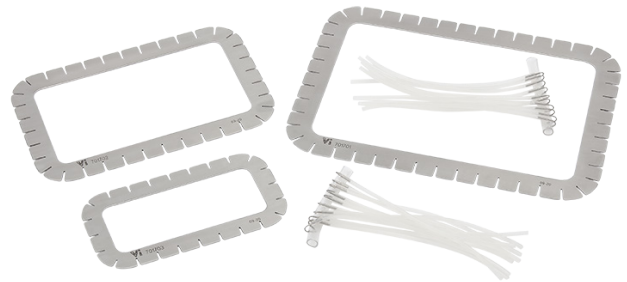

The strips are manufactured from silicone with a stainless hook. The strips are autoclavable but will require periodic replacement.

All the rings fit into standard counter-top autoclaves.

Please note: Vi Sterile Hooks are compatible with other retractor systems.

701700 Ring Retractor Set - S, M, L Rings With 10 Sterile Hooks
701701 Large Ring 200 x 130mm Internal
701702 Medium Ring 160 x 85mm Internal
701703 Small Ring 110 x 40mm Internal
701HOOK-A Set of 10 Sterile Hooks

Ameroid Constrictors

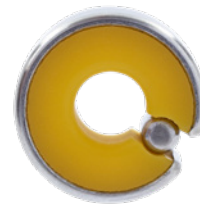

Supplied sterile. Used exclusively in the surgical treatment of hepatic shunts, the Ameroid Constrictor gradually occludes the blood vessel in question allowing the circulation to adjust.

The Casein (clay-like) layer expands as it absorbs water, constricting the blood vessel within. Insertion of metal locking key prevents constrictor from slipping from blood vessel.

Colour variation of the Casein material is normal and does not indicate a defect. The outer case is 304 Stainless Steel.

Selection of Ameroid Constrictor.

Once the portosystemic shunt has been identified and exposed it is suggested that a constrictor should be selected which initially encloses the vessel but does not constrict it.

AC35-A Ameroid Constrictor 3.5mm Sterile
AC40-A Ameroid Constrictor 4.0mm Sterile
AC45-A Ameroid Constrictor 4.5mm Sterile
AC50-A Ameroid Constrictor 5.0mm Sterile
AC60-A Ameroid Constrictor 6.0mm Sterile
AC70-A Ameroid Constrictor 7.0mm Sterile

Doyen Bowel Clamp

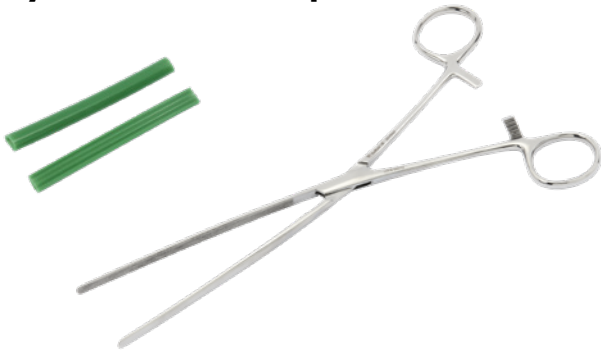

201950 Bowel Clamps Doyen Str 9.5" 24cm
201955 Bowel Clamps Doyen Cof 9.5" 24cm

Autoclavable soft silicone shoes created to fit the Doyen Bowel Clamps, making the Doyen more atraumatic. Ribs maximise grip.

EXTR201950 Silicone Shoe For Doyen Bowel Clamps 1 Pair
EXTR201950/3 Silicone Shoe For Doyen Bowel Clamps 3 Pairs
EXTR201950/10 Silicone Shoe For Doyen Bowel Clamps 10 Pairs
EXTR201950/20 Silicone Shoe For Doyen Bowel Clamps 20 Pairs

Atraumatic Small Bowel Clamp



Jaw design gently holds and seals the bowel with a minimum of pressure and trauma. The fine ratchet facilitates gentle yet secure application.

222165 Bowel Clamps Atraumatic Str 17cm 7" Long
222170 Bowel Clamps Atraumatic Cof 17cm 7" Long

Resano Bowel Clamp

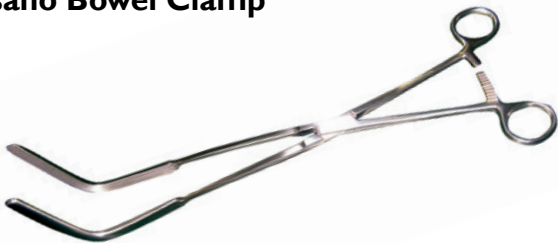

201956 Resano Bowel Clamp 20.5cm 8" Long

Soft Edge Surgical Spoon



Removing calculi from the bladder or impacted faeces from the rectum requires great care to avoid damage.

Our soft edge spoons have been designed and manufactured with veterinary procedures in mind.

Available in three sizes:

- XSmall 230 x 15 x 8mm
- Small 250 x 20 x 10mm
- Large 270 x 44 x 23mm

014703 Soft Edged Spoon - XSmall
014700 Soft Edged Spoon - Small
014701 Soft Edged Spoon - Large
014702 Soft Edged Spoon - Set of 3



Loan Kits

For a nominal fee, we have a range of **specialist loan kits** available to complement your own fleet. With next working day availability, the service offers flexibility as procedures are booked with your clients.

To find out more, scan the QR code below.



Norfolk Vet Products

The Norfolk and DocXS products are based around the CompanionPort device. This is a titanium port with a silicone septum which is implanted during a surgical procedure beneath the skin at a suitable site, depending on accessory connection required. The port is then accessed percutaneously using a special non-coring Huber point needle to either withdraw, sample or administer/flush as required, with minimal disturbance and distress to the patient.

Surgical guides and further information is available online at www.norfolkvetproducts.com

Pleural Port

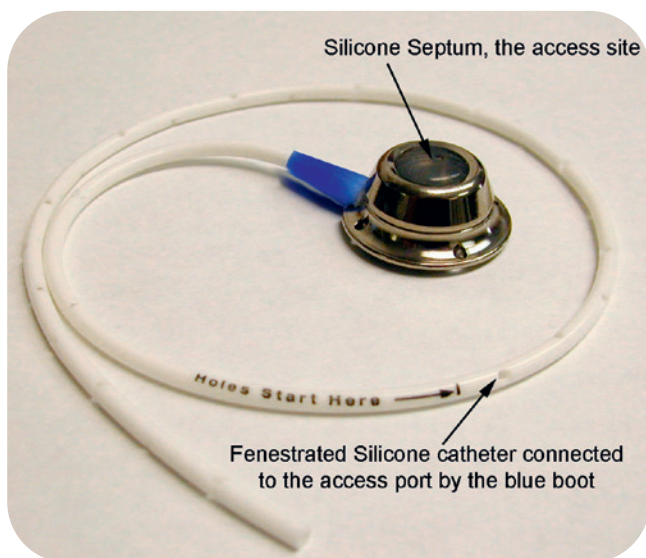

This version of the Port kit consists of a silicone fenestrated catheter for insertion into the thoracic cavity, with a CompanionPort and three sizes of Huber needle.

Indications for use are repeated aspiration of the thoracic cavity, or intra-cavity chemotherapy.

- NOR-PP-102K** Pleural Port - Dogs
- NOR-PP-202K** Pleural Port - Cats
- NOR-NPX-10** Introducer Kit for Canine Pleural Port



CompanionPort for Vascular Access

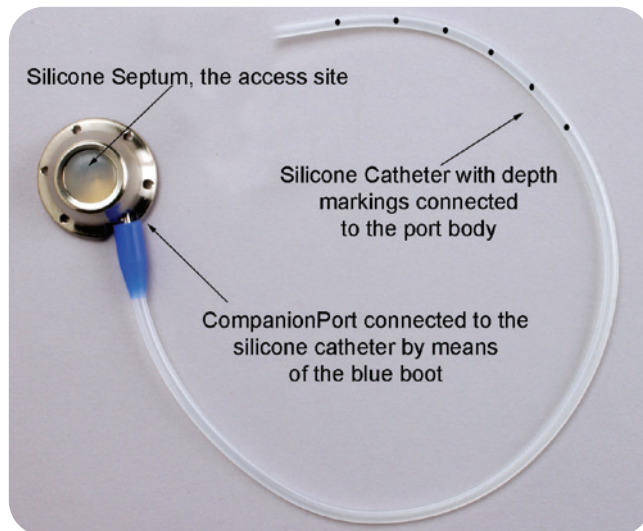

The CompanionPort for vascular access is designed to provide a more comfortable way of gaining repeated access to the venous system for both delivery of medication and repeat blood sampling.

Each kit contains a titanium port (3 sizes available) and a round tip radiopaque silicone catheter with depth markings. 22g Huber needles are included in all sizes.

- NOR-CP-100K** CompanionPort Vascular Access Le Petite - Small Cats
- NOR-CP202K** CompanionPort Vascular Access Le Port - Cats & Small Dogs
- NOR-CP305K** CompanionPort Vascular Access Le Grande - Larger Dogs



Training & Education

Our **e-learning platform** delivers a variety of technical and clinical educational material, in an engaging and interactive format.

With a CPD certificate awarded upon successful completion of each module, the e-learning platform from Vi will help you to fulfil your annual CPD requirements.

Sign up today by scanning the QR code below.



The SUB™ - A Subcutaneous Ureteral ByPass System

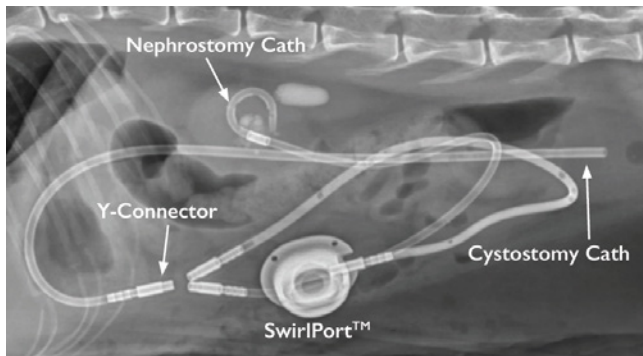

The Subcutaneous Ureteral Bypass (SUB™) device is a unique system designed for use in cats and dogs.

Redesigned to reduce some of the most common complications seen in prior SUB™ devices, the SUB™ 3.0 consists of one or two locking loop pigtail catheters placed in the kidney(s), one straight catheter placed in the bladder, a subcutaneous titanium SwirlPort™, and a "Y" or "X" Connector for securing the catheters.

Indications for using the SUB™ 3.0 include:

- Ureteral Obstruction associated with Ureteral Stone Disease
- Ureteral Strictures – the abnormal narrowing of the ureter
- Ureteral Stent Reaction
- Ureteral Stent Intolerance
- Malignant Obstructions

Items included in the kit:

SwirlPort Access Port and Catheter Tubing, Locking Loop Nephrostomy Catheter(s), Straight Bladder Catheter, "Y" or "X" Connector, .035" J-Tip Guidewire, 2 x Posi-grip Huber Point Needles, Over-the-Needle IV Catheter(s), Blue Boot Catheter Connectors.

NOR-SUB3-2001K	Sub Device 3.0 Kit Cats & Small Dogs
NOR-SUB3-2002K	Sub Device 3.0 Kit Long for Larger Dogs
NOR-SUB3-3001K	Sub Device 3.0 Kit Bilateral for Cats & Small Dogs

Not included in the kit - optional extras include:

I050052	Histoacryl Tissue Glue (Pack of 5)
NOR-SFK-20	20g Sub Flush Kit (Case of 5)
NOR-SFK-22	22g Sub Flush Kit (Case of 5)
NOR-TFL-1202	T-FLOLOC™ 2ml 2% Tetra EDTA Solution in 12ml Syringe Box of 10

Kit components available separately:

NOR-BC-7	Bladder Catheter 7FR
NOR-LL6.5	Kidney (Pigtail) Catheter 6.5FR
NOR-SHU-PP	3 Way Sub Port Only
NOR-GW-035	J Tipped 0.035" Guide Wire
DC-7	Metal Male To Male Adaptor For Sub Device
NOR-SP4	Medium Swirlport For Sub 3.0 Port Only
NOR-X-CONNECTOR	4 Way X Connector For Bilateral Sub 3.0
NOR-Y-CONNECTOR	3 Way Y Connector For Unilateral Sub 3.0

Artificial Urethral Sphincter (AUS) Port System

The Artificial Urethral Sphincter Port System (AUS™) is designed for dogs and cats for the long-term relief of sphincter mechanism incontinence that is unresponsive to medical management.

The AUS Port system has 2 components: a titanium access port and a silicone AUS occluder catheter.

The device employs a silicone cuff placed around the proximal urethra and filled with variable amounts of saline to provide mechanical obstruction to urine flow through the urethra. The degree of resistance to flow is adjusted using a subcutaneous access/injection port that is subcutaneously placed on the inner thigh. There is no exit site.

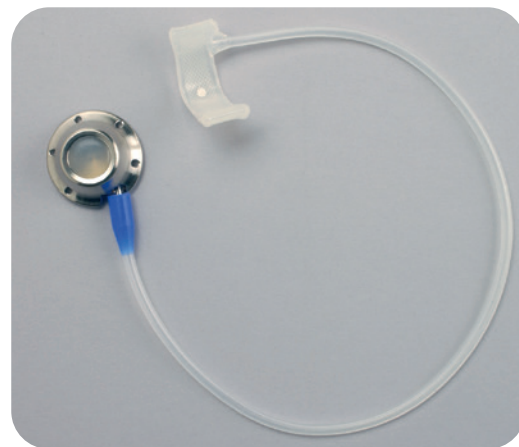

The AUS Port System – the access port, occluder and accessories – are packaged as a sterile kit complete with Huber point accessing needles.

DXAUS-KIT-6X11	AUS Port System Kit 6 x 11mm Cuff
DXAUS-KIT-10X11	AUS Port System Kit 10 x 11mm Cuff
DXAUS-KIT-6X14	AUS Port System Kit 6 x 14mm Cuff
DXAUS-KIT-8X14	AUS Port System Kit 8 x 14mm Cuff
DXAUS-KIT-10X14	AUS Port System Kit 10 x 14mm Cuff
DXAUS-KIT-12X14	AUS Port System Kit 12 x 14mm Cuff
DXAUS-KIT-14X14	AUS Port System Kit 14 x 14mm Cuff
DXVO-CATH45	AUS & HSO Backfill/Flush Catheter

AUS Port System Components

Access Port available in 3 sizes supplied sterile with Huber needles:

DXAUS-KIT-CP6	Companion Port Kit S Sterile
DXAUS-KIT-CP4	Companion Port Kit M Sterile
DXAUS-KIT-CP2	Companion Port Kit L Sterile

Most common size can be purchased as port only supplied sterile:

DXAUS-CP4	Companion Port Only M
------------------	-----------------------

Cuffs available individually; supplied sterile:

DXAUS-4X11	Artificial Urethral Sphincter 4x11mm Sterile
DXAUS-6X11	Artificial Urethral Sphincter 6x11mm Sterile
DXAUS-6X14	Artificial Urethral Sphincter 6x14mm Sterile
DXAUS-8X11	Artificial Urethral Sphincter 8x11mm Sterile
DXAUS-8X14	Artificial Urethral Sphincter 8x14mm Sterile
DXAUS-10X11	Artificial Urethral Sphincter 10x11mm Sterile
DXAUS-10X14	Artificial Urethral Sphincter 10x14mm Sterile
DXAUS-12X11	Artificial Urethral Sphincter 12x11mm Sterile
DXAUS-12X14	Artificial Urethral Sphincter 12x14mm Sterile
DXAUS-14X11	Artificial Urethral Sphincter 14x11mm Sterile
DXAUS-14X14	Artificial Urethral Sphincter 14x14mm Sterile
DXAUS-16X11	Artificial Urethral Sphincter 16x11mm Sterile
DXAUS-16X14	Artificial Urethral Sphincter 16x14mm Sterile

Hepatic Shunt Occluder (HSO) System



The Hepatic Shunt Occluder (HSO™) Port System is designed to produce gradual and complete occlusion of Congenital Portosystemic Shunts (IHPS) that is percutaneously controlled through an access port. The occlusion is easily reversed if postoperative portal hypertension occurs.

The HSO-Port System consists of an inflatable silicone cuff and a titanium access port.

The full kit contains:

- 1 x access port (Medium supplied as standard)
- 1 x HSO (size as selected)
- 2 x 22g Huber point needles
- 1 x 22g right angle infusion set

DXHS-KIT-HS-4	Hepatic Shunt Kit 4mm
DXHS-KIT-HS-6	Hepatic Shunt Kit 6mm
DXHS-KIT-HS-8	Hepatic Shunt Kit 8mm
DXHS-KIT-HS-10	Hepatic Shunt Kit 10mm
DXHS-KIT-HS-12	Hepatic Shunt Kit 12mm
DXHS-KIT-HS-14	Hepatic Shunt Kit 14mm
DXHS-KIT-HS-16	Hepatic Shunt Kit 16mm
DXVO-CATH45	AUS & HSO Backfill/Flush Catheter

Access Port available in 2 sizes supplied sterile with Huber needles:

DXAUS-KIT-CP4	Companion Port Kit M Sterile
DXAUS-KIT-CP2	Companion Port Kit L Sterile

Most common size can be purchased as port only supplied sterile:

DXAUS-CP4	Companion Port Only M
------------------	-----------------------

HSO available singly, supplied sterile:

DXHS-4	Hepatic Shunt Occluder 4mm Sterile
DXHS-6	Hepatic Shunt Occluder 6mm Sterile
DXHS-8	Hepatic Shunt Occluder 8mm Sterile
DXHS-10	Hepatic Shunt Occluder 10mm Sterile
DXHS-12	Hepatic Shunt Occluder 12mm Sterile
DXHS-14	Hepatic Shunt Occluder 14mm Sterile
DXHS-16	Hepatic Shunt Occluder 16mm Sterile

Huber Needles



These special non-coring needles are required to access the silicone septum of the CompanionPort without the damage associated with traditional needles. They are also known as deflected-point needles. When withdrawn after use, the septum re-seals itself.

NOR-NV-PG22-75	22g Huber Needle 3/4" Black Box of 12
NOR-NV-PG22-100	22g Huber Needle 1" Black Box of 12
NOR-NV-PG20-75	20g Huber Needle 3/4" Yellow Box of 12
NOR-NV-PG20-100	20g Huber Needle 1" Yellow Box of 12
NOR-NV-PG19-75	19g Huber Needle 3/4" Brown Box of 12
NOR-NV-RA19-100	19g Huber Needle 1" Box of 12
NOR-NV-RA22-75-6	22g Right Angle Huber 3/4" with 6" Extension Box of 12
DXHUBERRIGHT	22g Right Angle Huber Infusion Set 3/4" Single Sterile

SUB Flush Kit

This convenient kit contains the items you need to quickly and effectively flush the SUB™ System.

SUB™ Flush Kit Contents

SFK-22 – for use with All Shunting Ports

- 1x T-Port Connector
- 1x 3-Way Stop-Cock
- 1x 22-Gauge Huber Point Needle
- 2x 3ml Syringe
- 1x 2.5ml Sterile Saline in 3ml Syringe
- 1x 2ml T-FloLoc in 12ml Syringe

NOR-SFK-22	22g Sub Flush Kit (Case of 5)
-------------------	-------------------------------

SFK-20 – option for Swirl and Large Shunting Ports

- 1x T-Port Connector
- 1x 3-Way Stop-Cock
- 1x 20-Gauge Huber Point Needle
- 2x 3ml Syringe
- 1x 2.5ml Sterile Saline in 3ml Syringe
- 1x 2ml T-FloLoc in 12ml Syringe

NOR-SFK-20	20g Sub Flush Kit (Case of 5)
-------------------	-------------------------------

T-FloLoc

2% Tetra-EDTA Flush and Lock Solution

NOR-TFL-1202	T-FloLoc™ 2ml 2% Tetra EDTA Solution in 12ml Syringe Box of 10
---------------------	--

Penrose Drains



Latex rubber. Use to maintain drainage from infected wounds. Also useful to retract soft tissues such as blood vessels and nerves.

- 090168** Penrose Drain 1/4" 40cm 16" Long Sterile
- 090165** Penrose Drain 1/2" 40cm 16" Long Sterile

Kitty Kollar Tube Collar



The placement of oesophagostomy 'E' feeding tubes is a growing modality in small animal medicine. Many 'E' Tubes have been successfully in place for years on some patients. The challenge of the 'E' Tube is its care and maintenance.

The Kitty Kollar was designed as a sensible solution to the everyday patient management of the 'E' Tube. The adjustable collar fits securely around the animal's neck. It has a small hole for the 'E' Tube to pass through. A velcro strap secures or holds the 'E' Tube flat when not in use. Circular cotton pads with a center hole are provided to be placed between the collar and the skin. They protect the wound and absorb drainage eliminating the need for owners to learn bandage techniques or repeated clinic visits for rebandaging. Includes 6 protector pads and laminated instruction card.

Code	Circumference of Neck in Inches	Length of Collar + Tab in Inches	Size
KTK-XS	4" - 7"	5.5" + 2"	X-Small
KTK-PF	8" - 9"	9" + 2"	Petite
KTK-F	10" - 12"	11" + 2"	Small
KTK-M	12" - 16"	13" + 3"	Medium
KTK-L	17" - 19"	18.5" + 3"	Large
KTK-XL	20" - 24"	21" + 3.5"	X-Large

- KTK-XS** Kitty Kollar Tube Collar - X-Small
- KTK-PF** Kitty Kollar Tube Collar - Petite
- KTK-F** Kitty Kollar Tube Collar - Small
- KTK-M** Kitty Kollar Tube Collar - Medium
- KTK-L** Kitty Kollar Tube Collar - Large
- KTK-XL** Kitty Kollar Tube Collar - X-Large
- KTK-PADS** Spare Replacement Pads - Pack of 24



Polyester Mesh

Use polyester mesh to repair soft tissue defects where alternative autografts are not available. E.g. perineal hernia, umbilical hernia. Mesh loop diameter 1mm. Sheet size 60mm x 120mm Supplied single pack sterile.

- PM60120** Polyester Mesh 60mm x 120mm Single

Anal Sac Kit



Anal sac conditions such as impaction or abscess formation are a common, often reoccurring problem in small animal medicine. The surgical excision of both anal sacs can be elected as a permanent solution to these reoccurring issues.

- ASEK5** Anal Sac Excision Kit Pack of 5

Enema Pump

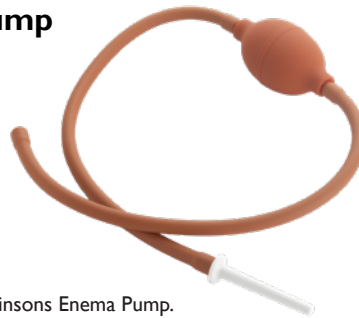

The original Higginsons Enema Pump.

- G1894** Higginsons ENEMA pump

Biopsy Needles

Soft Tissue Tru-Cut Style



Used to sample liver, kidney and other soft tissues with minimal trauma. Takes just a small sliver of tissue. Supplied sterile - single use only. Needle is "locked" and when released, spring loaded cutting needle takes the biopsy. 14g has two stop system and can take either 10mm or 20mm samples.

- STB18** Vi Trucut Type Supercore Biopsy Needle 14g x 90mm
- STB18B** Vi Trucut Type Supercore Biopsy Needle 18g x 90mm

Temno Evolution Biopsy Needle



The standard soft tissue biopsy needle used by the NHS. 2 different sample sizes can be selected when pulling the plunger. One click equals a 10mm notch exposure, two clicks 20mm.

- TEM1420/1** Temno Evolution Biopsy Needle 14g x 200mm Single
- TEM1420/5** Temno Evolution Biopsy Needle 14g x 200mm 5 Pack

Disposable Skin Biopsy Punch



Disposable skin biopsy punch with razor-sharp stainless steel blade. Light weight, ribbed plastic handle for control and comfort. 4mm, 6mm and 8mm diameters available. Supplied sterile.

SBP4	Skin Biopsy Punch 4mm Diameter Head
SBP6	Skin Biopsy Punch 6mm Diameter Head
SBP8	Skin Biopsy Punch 8mm Diameter Head
SBPSET	Skin Biopsy Punch Set of 3 (4mm, 6mm, 8mm)

Flushing Needles

Flushing needles have a bead or olive soldered onto the tip to minimise trauma to friable soft tissues.

Ear Flushing Needles - Spreulls



Often referred to as Spreulls needles these blunt beaded needles are available in 60mm and 100mm lengths with a Luer hub.

012510	Ear Flushing Spreulls Needle Short 60mm
012511	Ear Flushing Spreulls Needle Long 100mm

Flushing Needle 21 Gauge



Suitable for anal gland ducts of small dogs. Ideal for flushing the urethra in the male cat prior to placement of catheter. Start with the 30mm needle and move to the 50mm and 75mm versions as urethra clears.

012512	Flushing Needle 21g Bead Tip 30mm
012512L	Flushing Needle 21g Bead Tip 50mm
012512XL	Flushing Needle 21g Bead Tip 75mm

Oral Dosing Needles



Suitable for oral dosing and feeding of birds and reptiles. Available in a range of gauges from 12G to 23G. Care should be taken to ensure the needles cannot be swallowed.

012513	12g Oral Dosing Needle 200mm Curved
012514	14g Oral Dosing Needle 125mm Curved
012515	16g Oral Dosing Needle 75mm Straight
012515C	16g Oral Dosing Needle 75mm Curved
012515STR	16g Oral Dosing Needle 100mm Straight
012516	18g Oral Dosing Needle 50mm Straight
012516C	18g Oral Dosing Needle 50mm Curved
012517	20g Oral Dosing Needle 38mm Straight
012517C	20g Oral Dosing Needle 38mm Curved
012517CS	20g Oral Dosing Needle 25mm Curved
012517S	20g Oral Dosing Needle 25mm Straight
012527	22g Oral Dosing Needle 38mm Straight
012527C	22g Oral Dosing Needle 38mm Curved
012522	23g Oral Dosing Needle 25mm Straight
012532	Raptor Crop Tube 7mm Diameter 18cm Long

Intraosseous Infusion Needle 18g



Where vascular access is difficult, fluids and most drugs can be administered via this intraosseous infusion needle. This process is particularly useful in neonates and birds where blood vessels are very small.

The most common site is the proximal femur via the trochanteric fossa. An IV catheter should be placed as soon as practical. Also used as a small bone marrow aspiration needle in the Jamshidi Style.

BMBJV18	Intraosseous Infusion Needle 18g
----------------	----------------------------------

V.A.C.® Therapy

Please note the VAC unit has been discontinued by the manufacturer, we will continue to supply consumables while stock is still available.



Dressings sizes (unless stated):

- Small = 10x7cm
- Medium = 18x12cm

For more information on dressing management see the V.A.C.® Therapy for Veterinary Use User Manual or the Quick Start Manual, both available on request.

- KCIM8275051/5** V.A.C.® GRANUFOAM™ Small Dressing Kit - Pack of 5
- KCIM8275052/5** V.A.C.® GRANUFOAM™ Medium Dressing Kit - Pack of 5
- KCIM8275052/1** V.A.C.® GRANUFOAM™ Medium Dressing - Single
- KCIM8275096/5** V.A.C.® GRANUFOAM SILVER™ Medium Dressing Kit x5
- KCIM8275096/1** V.A.C.® GRANUFOAM SILVER™ Medium Dressing Kit Single
- KCIM8275098/5** V.A.C.® GRANUFOAM SILVER™ Small Dressing Kit x5
- KCIM6275033/10** V.A.C.® WHITEFOAM™ Small Dressing - Pack of 10
- KCIM8275058/5** ACTIV.A.C.™ 300ml Canister With Gel - Pack of 5
- KCIM8275058/1** ACTIV.A.C.™ 300ml Canister With Gel - Single
- KCIM6275026/10** V.A.C.® Gel Strips - Pack of 10
- KCIM6275009/10** V.A.C.® Drape - Pack of 10
- KCIM6275009/1** V.A.C.® Drape - Single
- KCIM6275066/10** V.A.C.® Y-Connector
- KCIM8275057/10** SENSAT.R.A.C.™ Pad - Pack of 10
- KCIM8275057/1** SENSAT.R.A.C.™ Pad - Single

Stomach Tubes



- EQSTS** PVC Stomach Tube Small 10mm Diameter
- EQSTM** PVC Stomach Tube Medium 15mm Diameter
- EQSTL** PVC Stomach Tube Large 20mm Diameter
- EQSTF** PVC Stomach Tube Foal

Skin Stapler



- STAP35W** Skin Stapler 35W Sterile Single
- STAP35W5** Skin Stapler 35W Sterile Pack of 5

Skin Staple Remover



- STAPREM** Skin Staple Remover Single



Email Marketing Service

Our marketing emails are designed to **educate**, to keep you up to date with what's new at Vi and share **exclusive offers and discounts**.

Sign up today by scanning the QR code below.

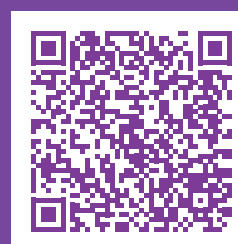



VETIGEL®

Exclusively available from Vi®

VETIGEL® is a haemostatic gel that is designed to stop moderate to severe bleeding within seconds. VETIGEL® helps control bleeding in animals by achieving haemostasis in seconds without the need for manual pressure.

VETIGEL® can be used on a variety of procedures, including but not limited to: dental extractions, oral mass removals, abdominal and thoracic mass removals, soft organ biopsies, enucleations, spays and neuters, amputations, venous and arterial bleeds, cholecystectomies, catheterisation, and lacerations.

VETIGEL® Haemostatic Gel



VET-02 VETIGEL Haemostatic Gel 2 x 5ml
VET-05 VETIGEL Haemostatic Gel 5 x 5ml

Lyostypt®



Lyostypt® is a wet-stable collagen haemostat. Collagen leads to thrombocyte adhesion and to activation of coagulation factor XII. 30 x 50mm. 12 units per pack.

- Achieves haemostatis very swiftly
- Is completely absorbable
- Can be removed easily
- Can be applied endoscopically
- Can be combined with fibrin glue and antibiotics

I069128 Lyostypt® (12 Units)

VETIGEL® Accessory Packs



ACC-01 VETIGEL Haemostatic Gel 2 x Accessory Packs

Ophthalmic

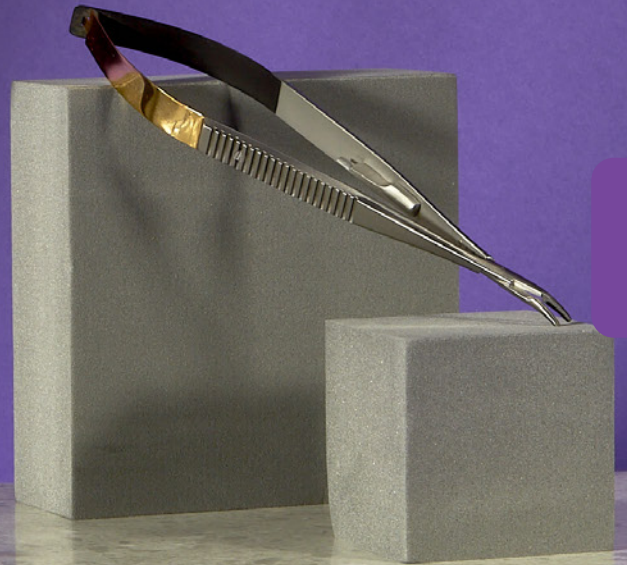

To view the Ophthalmic section of our website, please scan the QR code:



Ophthalmic Kit



The kit contains 10 instruments. All are contained in a stainless steel case with a protective silicone lining which minimises damage to the delicate instruments. As recommended by David Williams MA VetMB PhD CertVOphthal.

Basic ophthalmic surgery kit contents:

014175	Castroviejo's TC Needleholder With Catch 150mm	x1
014108	Stevens Tenotomy Scissors 110mm Str	x1
014210S	Castroviejo's Corneal Scissors 115mm Str	x1
014191	Colibri Barraquer Forceps	x1
014162	Graefe Fixation Forceps	x1
014132	Roberts Tying Forceps 100mm	x1
014110	Barraquers Speculum Blade 30 x 10mm	x1
103175	Halstead Mosquito Artery Forceps 125mm Str	x1
103225	Halstead Mosquito Artery Forceps 125mm Cvd	x1
06054	Fine Beaver Type Scalpel Handle 130mm	x1
BX201040	Instrument Box 200 x 100 x 40mm	x1
BXSIL201040	Silicone Insert for Box For 200 x 100mm Instrument Box	x1
014130	Basic Ophthalmic Surgery Kit	

Needle Holders

Castroviejo



Classic ophthalmic needleholder with catch. Infrequent ophthalmic surgeons should also consider Miniature Fosters or Ryders as the squeeze action of Castroviejoes requires patience and practice to master. Also available without catch.

- 014175 Castroviejo Needle Holders With Catch T.C. 150mm
- 014177 Castroviejo Needle Holders Without Catch T.C. 150mm

Castroviejo Needle Holders/Scissor



This instrument functions as a standard Castroviejo needleholder but the jaws incorporate a suture cutting function in the style of Olsen Hegars or Gillies. Jaws are tungsten carbide for maximum grip.

- 014181 Castroviejo Needle Holders/Scissor Str T.C. 150mm
- 014182 Castroviejo Needle Holders/Scissor Cof T.C. 150mm Cof
- 014183 Castroviejo Needle Holders/Scissor Str 'S'Cut T.C. 150mm
- 014184 Castroviejo Needle Holders/Scissor Cof 'S'Cut T.C. 150mm



Loan Kits

For a nominal fee, we have a range of **specialist loan kits** available to complement your own fleet. With next working day availability, the service offers flexibility as procedures are booked with your clients.

To find out more, scan the QR code below.



Miniature Foster Gillies



602710 Miniature Foster Gillies T.C. 100mm 4"

Ryder Needle Holders



Ideal for small needles. The smaller sizes are an alternative for ophthalmic needleholders.

- 606340 Ryder (Micro) T.C. Jaws 12.5cm 5"
- 606345 Ryder (Micro) T.C. Jaws 15cm 6"
- 606350 Ryder (Micro) T.C. Jaws 18cm 7"

Derf Needle Holder



The Derf needle holder is a small T.C. needleholder with slightly heavier jaws than the Ryder. More resistant to surgeon abuse!

607010 Derf Needle Holder T.C. Jaws 12cm

Roberts Tying Forceps



Used in conjunction with the needle holders to tie knots in fine material.

014132 Roberts Tying Forceps 100mm

Eyelid - Speculae

Desmarres Eyelid Retractor



014215-M Medium 14mm Wide 140mm

Lister Speculum



This speculum is adjustable and has a locking mechanism. The shape is contoured for minimum interference with sutures and instruments.

014115 Lister Speculum 40mm Gape 80mm Length

Barraquer Speculum

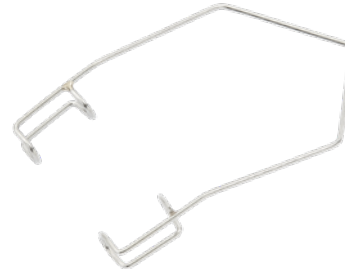

This simple spring loaded speculum is ideal for most procedures which do not require a locking speculum. No protuberances to catch sutures.

- 014110 Barraquer Speculum Large 30mm Gape 10mm 'Blade'
- 014112 Barraquer Speculum Small 25mm Gape 5mm 'Blade'

Jaeger Eyelid Speculum



Useful during wedge resections of eyelids. The speculum stretches and retains the eyelid prior to dissection, with the blade cutting down onto the metal of the speculum which protects the eye.

- 014120 Jaeger Eyelid Speculum (Stainless) 100mm
- 014121 Jaeger Eyelid Speculum Insulated 110mm

Ophthalmic Forceps

Castroviejo's Corneal Forceps



014190 Castroviejo's Corneal Forceps 105mm Long

Arruga Capsule Forceps



014150 Arruga Capsule Forceps 100mm Long

St Martins Corneal Forceps



014160 St Martins Corneal Forceps

Bennet's Cilia Forceps



Favoured by some surgeons the circular tips give good focal grip of individual cilia.

342460 Bennets Cilia Forceps 80mm Long

Colibri (Barraquers) Forceps



014191 Colibri (Barraquers) Forceps 75mm Long

Epilation Forceps



342450 Epilation Forceps Square Jaws Plain

Graefe Iris Forceps



014195 Graefe Iris Forcep Serrated 105mm Long

014196 Graefe Iris Forceps Straight 1/2 Teeth 105mm Long

Bishop Harmon Forceps



014163 Bishop Harmon Forceps 1/2 Teeth 90mm

Graefe Fixation Forceps



014162 Graefe Fixation Forceps 3.5mm Jaws 105mm Long

Ophthalmic Scissors

Pooley's Conjunctival Scissors



746350 Pooley's Conjunctival Scissors 85mm Long

Castroviejo Corneal Scissors



Squeeze action, very delicate scissor used to extend the stab corneal incision.

014210 Castroviejo Corneal Scissors Cof 115mm Long
014210S Castroviejo Corneal Scissors Str 115mm Long

Strabismus Scissors



Stronger than corneal and conjunctival scissors, strabismus scissors are suitable for cutting muscles and skin.

746900 Strabismus Scissors Str 90mm
747010 Strabismus Scissors Cof 90mm
746910 Strabismus Scissors Str 110mm
747020 Strabismus Scissors Cof 110mm

Iris Scissors



A useful general purpose ophthalmic scissor. Lightweight, standard action scissor for conjunctiva and, less satisfactorily, the cornea. Very rarely used on the iris in veterinary ophthalmology.

744100 Iris Scissors Str 90mm
744120 Iris Scissors Cof 90mm
744110 Iris Scissors Str 115mm
744110L Iris Scissors Str 115mm Left Handed
744130 Iris Scissors Cof 115mm
744130L Iris Scissors 115mm Cvd Left Handed
744131 Iris Scissors Tungsten Carbide Str 115mm

Steven's Tenotomy Scissors



014108 Steven's Tenotomy Scissors Straight 110mm Long
014108CV Steven's Tenotomy Scissors Curved 110mm Long

Eye Enucleation Scissors



Standard curved surgical scissors do not match the radius of the eye of dogs and cats.

The eye enucleation scissor closely matches required radius and slides easily behind the eyeball to cut the optic nerve and internal ophthalmic artery and vein, without the requirement to apply dangerous traction to the globe. Use in conjunction with eye enucleation forceps.

014225 Eye Enucleation Scissors 140mm

Eye Enucleation Forceps



It is very important to clamp and crush the optic nerve and internal ophthalmic artery and vein.

The curvature on standard artery forceps is not correct and if used, the handles stand up in the way. The Enucleation Forceps are designed to slide around the rear of the globe and capture the blood vessels. The jaws are then levered against the edge of the orbit to elevate the globe for ease of tying. The handles curve out of the way.

Use with eye enucleation scissors. The large size is more suitable for large animal work.

- 014219 Eye Enucleation Forceps 135mm
014219L Eye Enucleation Forceps Large 155mm

Chalazion Forceps (Desmarres)



- 014216 Chalazion Forceps (Desmarres) 3.5"

Snellen's Vectis



Use to apply pressure to globe to extrude lens rather than 'fishing' for it within the eye.

- 014101 Snellen's Vectis 135mm

Kimura Spatula



Use to apply pressure to globe to extrude lens rather than 'fishing' for it within the eye.

- 014103 Kimura Platinum Spatula 145mm

Distichiasis Clamp

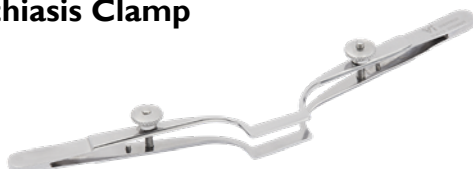

- 014113 Distichiasis Clamp 170mm

Punctum Dilator



- 014116 Nettleship Dilator Single Ended 100mm
014117 Castroviejo Double Ended Punctum Dilator 130mm

Lachrymal Cannulae



- 014221 Harrison Butler Lachrymal Cannula Curved 40mm



- 014224 Lachrymal Cannula Straight Stainless Steel

Rabbit Nasolachrymal Duct Cannulae



- 012523 Nasolachrymal Duct Cannula 19 Gauge
012524 Nasolachrymal Duct Cannula 21 Gauge
012525 Nasolachrymal Duct Cannula Set 21 & 19G

Dental



To view the Dental section of our website, please scan the QR code:

Dental Elevators

Elevator or Luxator?

Elevator: A stocky strong blade used to extract loose teeth using adjacent sound teeth. Not usually meant to go below the gumline. The elevator has a thicker, more robust chisel-shaped working tip. This instrument can be used as a prying lever, or with rotation, or in a 'wheel and axle' manner, to achieve displacement of the tooth root. Very high forces can be generated so fingertip manipulation only is appropriate.

They will fracture if the periodontal ligament fibres are not loosened or cut before forceps are applied or if the instrument is torqued.

Luxator: A razor sharp, thin-tipped wedging instrument used to cut the periodontal ligament and create a wedging force. The luxator is a fine instrument and is at risk of damage if used incorrectly. It is not to be used in a prying or twisting motion. It will blunt quickly and sharpening before each use is appropriate.

Comfort Handle Elevators



Designed and developed by David Strong MRCVS, this popular pattern fits into the palm of the hand allowing the fore finger to be positioned along the shaft for added control.

Supplied with fully autoclavable coloured-coded PTFE handle. Available singly or as a set. When purchased as a set the stainless steel autoclave case comes free.

- 012601 Comfort Elevator 1mm (White)
- 012602 Comfort Elevator 2mm (Green)
- 012603 Comfort Elevator 3mm (Blue)
- 012604 Comfort Elevator 4mm (Black)
- 012600 Comfort Elevators Set of 4 (Includes Free Stainless Steel Case)
- 012605 Comfort Elevator 5mm (Grey)
- 012606 Comfort Elevator 6mm (Yellow)
- 012608 Comfort Elevator Set of 6 (Includes Free Stainless Steel Case)

Comfort Handle Winged Elevators

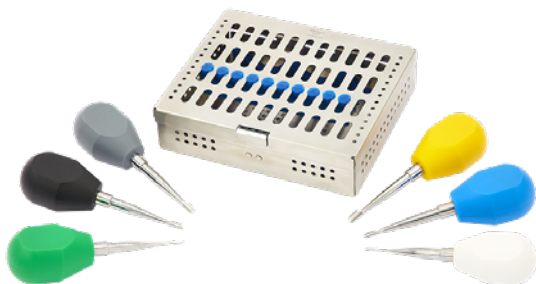

- 012611 Comfort Winged Elevator 1mm (White)
- 012612 Comfort Winged Elevator 2mm (Green)
- 012613 Comfort Winged Elevator 3mm (Blue)
- 012614 Comfort Winged Elevator 4mm (Black)
- 012610 Comfort Winged Elevators Set of 4 (Includes Free Stainless Steel Case)
- 012615 Comfort Winged Elevator 5mm (Grey)
- 012616 Comfort Winged Elevator 6mm (Yellow)
- 012618 Comfort Elevator Set of 6 (Includes Free Stainless Steel Case)
- 012617 Comfort Winged Elevator 7mm (Red)
- 012619 Comfort Winged Elevator 8mm (Purple)

Winged Elevators



Veterinary Elevators designed by Dr Robert Wiggs. They have short winged blades with lateral edges which curve upwards further than traditional elevators, improving conformation to the root structure as well as instrument control. The narrow neck enhances visibility of the root and the shorter shaft improves handling and control, especially if the operator's hands are not large.

The design incorporates the best parts of an elevator and a luxator. Aluminium knurled handles are very comfortable in use. Flattened surface prevents rolling off the table.

Available singly or as a set of 4 in stainless steel autoclave case.

- 012389 Winged Elevator 1mm (Pink) 145mm
- 012390 Winged Elevator 2mm (Gold) 145mm
- 012391 Winged Elevator 3mm (Blue) 145mm
- 012392 Winged Elevator 4mm (Black) 145mm
- 012393 Winged Elevators Set of 4 (Includes Free Stainless Steel Case)
- 012395 Autoclavable Stainless Steel Case For Winged Elevators

Winged Elevators With Short Handles



Our short handled winged elevators are predominantly designed to support users with smaller hands. The stainless steel case is silicone lined to minimise damage to the elevators, whilst being a convenient storage device during the sterilisation and transportation of the elevators.

- 012401 Short Winged Elevators Rainbow 1mm 125mm
- 012402 Short Winged Elevators Gold 2mm 125mm
- 012403 Short Winged Elevators Slate 3mm 125mm
- 012404 Short Winged Elevators Black 4mm 125mm
- 012405 Short Winged Elevators Set of 4 In Stainless Steel Case

Wedge Elevator



Designed to remove the carnassial without the need to split the tooth.

012010 Wedge Elevator 170mm

Small Feline Elevator



The 2mm angled tip on a fine handle allows access to lingual surfaces. Also useful in the extraction of rabbit incisors.

012018 Small Feline Elevator 165mm

Superfine Elevator



012004 Superfine Elevator 2mm Straight

Double Ended Elevator



The curved tips are designed to follow the concave and convex curvatures of the roots, helping to prevent breaking the roots.

012036 Double Ended Elevator 2mm 185mm

012038 Double Ended Elevator 4mm 190mm

Molt Periosteal Elevator



The molt is a double ended periosteal elevator. The tips are round and dished. 4mm and 6mm diameters.

001275 Molt Periosteal Elevator 200mm

Periosteal Elevator



Used for raising full thickness mucogingival flaps before surgical extraction of teeth, bone removal and sectioning.

001270 Periosteal Elevator 4mm/7mm 195mm

7350/05 Freer Periosteal Elevator 5mm 180mm

001271 AO Type Periosteal Elevator PTFE Handle Curved Tip 6mm 180mm

001272 Periosteal Elevator Very Fine 2mm/3mm 180mm Long

Carnivore Elevator



Thin and very sharp. Used to remove tooth root fragments.

012001 Carnivore Elevator No. 1 (2.5mm) 145mm

012002 Carnivore Elevator No. 2 (3.5mm) 150mm

012003 Carnivore Elevator No. 3 (4.0mm) 150mm

012001/4S Set of Carnivore Elevators Nos. 1, 2, 3 & Wedge Elevator

Apical Elevator



Used to remove tooth root fragments.

012006 Heidbrink Apical Elevator 145mm

Couplands Elevators



This is the standard human elevator.

012015 Couplands Chisel No. 1 (3.0mm) 150mm

012016 Couplands Chisel No. 2 (4.0mm) 150mm

012017 Couplands Chisel No. 3 (5.0mm) 150mm

Dental Luxators

Forte Luxators



- 012174 Forte Luxator 2.5mm Black/Green 160mm
- 012175 Forte Luxator 3.2mm Black/Grey 160mm
- 012176 Forte Luxator 4mm Black/Brown 160mm
- 012172 Forte Luxator Set of 3
- FIXUS1 Luxator Autoclave Case

Luxators



- 012177 Luxator 1mm Straight 160mm
- 012190 Luxator 2mm Straight 160mm
- 012191 Luxator 3mm Straight 160mm
- 012192 Luxator 3mm Curved 160mm
- 012194 Luxator 5mm Straight 160mm
- 012195 Luxator 5mm Curved 160mm
- 012192/CA Luxator 3mm Contra Angle 160mm
- 012196VET Veterinary Luxator Set of 5 With Stone

Luxating Elevators



- 012162 Luxating Elevator Straight 2mm
- 012164 Luxating Elevator Straight 3mm
- 012166 Luxating Elevator Straight 4mm
- 012168 Luxating Elevator Straight 5mm

Periodontal Instruments

Periodontal Hand Instrument Set

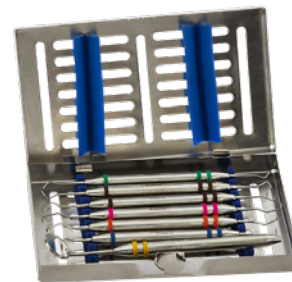

Seven periodontal instruments in a stainless autoclave case.

Instruments include: mirror, shepherd hook explorer/measuring probe, straight curette scaler, angled curette scaler, angled Jaquette scaler plus two fine probes.

- 012210 Periodontal Instrument Set In Autoclave Case

Hoe Periotome



- 012105 Hoe Periotome Double Ended

Explorer/Measuring Probe



The Shepherd's Crook Explorer is used to test tooth stability and the condition of the gum margins.

The depth of these sulci are measured using the measuring probe.

- 012100 Shepherd's Crook Explorer/ Measuring Probe 170mm

Subgingival Curette



This scaler is used to remove subgingival tartar and to plane tooth roots. The back surface of the scaler is blunt to minimise damage to the sensitive gingiva. The instrument is double-ended and has a balanced grip for extra comfort in use.

- 012130 Subgingival Curette 170mm

Jaquette Supragingival Scaler



This scaler is used to remove tartar from above the gum margin. The tip and back of the instrument is sharp to scrape between teeth. Do not use below the gum margin. Double-ended with a balanced grip handle for ease of use and comfort.

- 012120 Jaquette Supragingival Scaler 170mm

Hoe Scaler



Useful for removal of large areas of tartar and plaque from flat tooth surfaces.

012110 Hoe Scaler 165mm

Double-Ended Scrapper



The tips of this instrument are of familiar design mounted in a comfortable handle. One end is a fine hook to remove tartar from between teeth, the other is a shallow scoop to break tartar from flatter surfaces.

012020 Double-Ended Scrapper 175mm

Gracey Double Ended Curette



012135 Gracey Double Ended Curette 7/8

012136 Gracey Double Ended Curette 13/14

012137 Gracey Root Plane Curette Double Ended 1/2

012138 Gracey Root Plane Curette Double Ended 13/14

Dental Forceps

Tartar Forceps



Our spring loaded tartar forceps are designed to sit comfortably in the hand to enable the veterinary dentist to remove bulky deposits from teeth.

012050 Tartar Forceps Spring Loaded 180mm

012051 Tartar Forceps Spring Loaded Cat Size 150mm

01205SET1 Tartar Forceps Set of 2 (As above)

Tartar Forceps Cupix Point



These tartar forceps are designed specifically for the removal of bulky tartar prior to scaling and polishing.

One jaw is cup shaped to locate onto the tooth tip and act as a fulcrum for the other jaw. The other jaw is a sharp hook to engage the tartar at the gum margin.

The jaws are designed to remove tartar from both flat surfaces and between teeth.

012052 Tartar Forceps Cupix Point Style 180mm

012053 Tartar Forceps Cupix Point Style 150mm

01205SET2 Tartar Forceps Set of 2 (As above)

Hawksbill Forceps



The multi-rooted teeth of the dog and cat should be loose before extraction by forceps.

The loosening may be due to dental disease or careful elevation. As well as firmly gripping the tooth to be extracted, appropriate dental forceps should support the tooth structure.

The Hawksbill forceps are designed specifically for the extraction of multi-rooted teeth in the dog and cat.

012030 Large Hawksbill Forceps 170mm

012040 Small Hawksbill Forceps 140mm

01204SET Hawksbill Forceps Set of 2 (As above)

Small Incisor Forceps



The tips of these forceps are ideal for the removal of single rooted, usually incisor teeth. Cross-hatched thumb area for extra control. Tips meet.

012070 Small Incisor Forceps 150mm

Narrow Tipped Extraction Tooth Forceps



A narrow tipped extraction forcep which meets at the tip to facilitate holding the tooth. Forceps are only used once the tooth has been loosened correctly, trying to forcibly extract without loosening will usually result in root breakage. Very useful for cats.

012072 Narrow Tipped Extraction Tooth Forceps

Vi Extraction Forceps



Vi extraction forceps are well suited to extraction of medium to large teeth. The jaws have fine serrations for increased grip.

As with all extractions it is important that the tooth involved is suitably elevated prior to the use of forceps. The teeth of our patients are much more tightly bound to the jaw than are human teeth.

- 012091 Vi Extraction Forceps Straight
- 012092 Vi Extraction Forceps Curved
- 012093 Vi Extraction Forceps Angled
- 012090 Vi Extraction Forceps Set of 3 (As above)

Root Fragment Set



Removal of fragmented roots can be a challenge particularly if the roots themselves are healthy. A combination of elevation and forcep work is usually required. The set of 3 forceps with differing jaw angles covers all situations. The handles are anatomical and ergonomic.

- 012075 Root Fragment Forceps Set of 3

Lip Retractor



The lip retractor solves the problem of retracting the lip for clear access to the teeth. It has a modified shape to prevent pinching the lip and the tips of the instrument are plastic-coated to minimise trauma. It can be adjusted by lightly bending. Autoclavable.

- 010147 Lip Retractor 160mm

Dental Mirrors



- 012028 Mirror Handle Cone Socket Single Ended
- 012029 Dental Mirror No.3 With Cone Socket
- 012031 Dental Mirror Complete

Mouth Gags & Wedges

Grays Mouth Gag



Simple action with spring to gently hold the jaws open.

- 012158 Hamilton Kirk Cat Gag Maximum Gape 40mm
- 012160 Grays Mouth Gag Small Maximum Gape 65mm
- 012170 Grays Mouth Gag Medium Maximum Gape 100mm
- 012180 Grays Mouth Gag Large Maximum Gape 140mm
- 012159 Grays Mouth Gag Set of 3

Smith Baxter Mouth Gag



Spring action maximises access but is less likely to overstretch the TMJ.

- 012795ES Smith Baxter Mouth Gag Extra Small Max Gape 5.5cm
- 012795S Smith Baxter Mouth Gag Small Max Gape 6.5cm
- 012795M Smith Baxter Mouth Gag Medium Max Gape 10cm
- 012795L Smith Baxter Mouth Gag Large Max Gape 14cm
- 012795EL Smith Baxter Mouth Gag Extra Large Max Gape 15.5cm
- 012795 Smith Baxter Mouth Gags Set of 5 (As above)

Mouth Wedge



The mouth wedge provides a simple effective means of holding the mouth open for routine dental procedures.

- 012790 Mouth Wedge Small
- 012791 Mouth Wedge Large
- 012795SET Mouth Wedge Set of 2 (As above)

Dental Chart Labels for Cats & Dogs

012200 Dental Chart Labels for Dogs Pack of 50

012201 Dental Chart Labels for Cats Pack of 50

Dental Burs

Head Shape	Diameter (Approx)	Carbide 5 Pack	Diamond 5 Pack
Small Round	0.5	5FG 1/4	
Medium Round	1.4	5FG4	5FG4D
Large Round	1.8	5FG6	5FG6D
Extra Large Round	2.1	5FG8	
Extra Small Taper Fissure	0.8	5FG698	
Small Taper Fissure	1.2	5FG701	
Small Taper Fissure Long Head	1.2	5FG701L	
Medium Taper Fissure	1.6	5FG702	5FG702D
Medium Taper Long Head	1.6	5FG702L	5FG702LD
Extra Small Flat Fissure	0.9	5FG556	
Small Flat Fissure	1.0	5FG557	

Table Top Rabbit Gag



This version of our well known gag has a white PTFE platform which makes the gag warmer for the anaesthetised small patient. It is easy to clean and may be autoclaved.

- 012207 Table Top Rabbit Gag
- 012209 Table Top Rabbit Gag & LED Light
- DENRODKIT Table Top Rabbit Gag LED Light & Full Hand Kit (Rod2)

LED Light For Table Top Gag

Illumination of the inside of the rabbit mouth is difficult without the hands of the surgeon getting in the way.

The rabbit gag LED light simply clips into the retaining mount which screws onto the threaded height-adjustment control. The flexible neck of the light can be adjusted for best effect. The powerful white LED lasts for approximately 100 hours on a set of AAA batteries.



012208 LED Light With Flexible Neck (Inc Clip)

Rabbit Dental Kits



Basic Kit (ROD1) contains:

012185	Rodent Mouth Gag	x1
012189A	Cheek Dilator Large Long Reach	x1
012197CR	Crossley Incisor Luxator	x1
012186	Rodent Molar Cutter	x1
012181	Rodent Rasp Small	x1
BX201040	Stainless Steel Box 200x100x40mm	x1

Full Hand Kit (ROD2) contains:

012185	Rodent Mouth Gag	x1
012188	Rodent Cheek Dilator Small	x1
012189	Rodent Cheek Dilator Large	x1
012189A	Cheek Dilator Large Long Reach	x1
012197CR	Crossley Incisor Luxator	x1
012197M	Crossley Molar Luxator	x1
012199	Molar Extraction Forceps	x1
012186	Rodent Molar Cutter	x1
012184	Rodent Spatula	x1
012181A-A	Molar Rasp Fine - Dlamond - Small	x1
BX201040	Stainless Steel Box 200x100x40mm	x1

Hand & Motor Kit (ROD3) contains:

001789	Diamond Disc (20mm)	x1
001791	Diamond Disc Safety Shield	x1
001792	Rabbit Bur Kit in Block (6 Burs)	x1
001793	Rabbit Bur Soft Tissue Protector	x1
012185	Rodent Mouth Gag	x1
012188	Rodent Cheek Dilator Small	x1
012189	Rodent Cheek Dilator Large	x1
012189A	Cheek Dilator Large Long Reach	x1
012197CR	Crossley Incisor Luxator	x1
012197M	Crossley Molar Luxator	x1
012199	Molar Extraction Forceps	x1
012186	Rodent Molar Cutter	x1
012184	Rodent Spatula	x1
012181A-A	Molar Rasp Fine - Diamond - Small	x1
BX201040	Stainless Steel Box 200x100x40mm	x1

This kit also requires a straight nose cone and air or electric drive power unit.

- ROD1 Basic Kit
- ROD2 Full Hand Kit
- ROD3 Hand & Motor Kit

Rodent Mouth Gag



The rodent mouth gag is a must for any practice looking to complete the examination and treatment of rabbit molars.

012185 Rodent Mouth Gag

Lightweight Rodent Mouth Gag



012185LW Rodent Mouth Gag Lightweight
012185LWS Rodent Mouth Gag Lightweight Small

Rodent Cheek Dilators



The small dilator is also useful as a small gag for guinea pigs and chinchillas.

012188 Rodent Cheek Dilator Small Max Gape 40mm Blade Length 15mm, Blade Width 10mm
012189 Rodent Cheek Dilator Large Max Gape 60mm Blade Length 22mm, Blade Width 15mm
012189A Rodent Cheek Dilator Long Reach - Blade Length 36mm, Blade Width 11mm Use With Long Burs Max Gape 35mm

Rodent Spatula



Use to deflect tongue and cheek to examine and treat molars.

012184 Rodent Spatula

Rodent Molar Rasp



The diamond coated rasps are designed to smooth off sharp edges without disturbing the delicate tooth roots. The small diamond rasp is contoured in two directions to enable it to sit nicely on top of the molars. Unsuitable for debulking but good for tidying.

012187 Rodent Tooth Rasp Large 165mm
012181 Rodent Tooth Rasp Small 180mm
012182 Rodent Molar Rasp Fine - Diamond Large 165mm
012181A-A Molar Rasp Fine - Diamond - Small
01218SET Rodent Molar Rasp Set of 4 (As above)

Double Ended Diamond Rasp



One end is concave to sit on and around the molars. The other end is flat. Each blade is 25mm long.

012173 Double Ended Diamond Rasp 205mm

Rodent Molar Cutter



Use to debulk or for trimming spurs and hooks.

012186 Rodent Molar Cutter 180mm
012186/S Rodent Molar Cutter Small 140mm
01218CUTSET Rodent Molar Cutter Set of 2 (As above)

Crossley Incisor Luxator



Designed by David Crossley to extract the very large rabbit incisors. Removal avoids the requirement for repeated cutting of overgrown maloccluded incisors. Shape of luxator matches tooth shape. A smaller version is available for guinea pigs and rats.

012197CR Crossley Incisor Luxator 195mm
012197R Small Crossley For Guinea Pigs & Rats 190mm
012197SET Crossley Incisor Luxator Set of 2 (As above)

Crossley Molar Luxator



Designed to facilitate extraction of molars with a minimum of damage to the alveolus and surrounding soft tissue. One cutting blade is for insertion down buccal or lingual surface. The other end of the instrument is set at right angles to penetrate between molars.

012197M Crossley Molar Luxator 160mm

Molar Extraction Forceps



There is very little space inside a rabbit mouth. These forceps are very slim and angled to fit in the mouth without totally obscuring the teeth.

012199 Rabbit/Guinea Pig Molar Forceps 160mm

Root Tip Extraction Forceps



Most chronic abscesses around the head of a rabbit are related to infected tooth roots. Removal of the offending root is a prerequisite for successful treatment. Designed by Frances Harcourt-Brown these modified needleholders are used to locate and lock onto the root tip via the abscess.

012206 Root Tip Extraction Forceps 160mm

Rabbit Bur Kit

Components of the kit are available separately.



Three burs have been selected by David Crossley as being suitable for the reduction of rabbit and chinchilla molar teeth. Our rabbit bur kit includes two of each bur in a stainless steel autoclavable block. All are HP fitting to fit into a 1:1 Straight Nose Cone (not included). When using the long bur (HL563) use the soft tissue protector to shield tongue and cheek.

The Rabbit Bur Kit in Block contains:

001792BLOCK.ONLY	Rabbit Burr Kit Block Only	x1
HL563	Very Long Cross Cut Flat Fiss (60mm)	x2
HP704	Taper Side Cut Bar 2.3mm	x2
HP8	Round Plain Cut 2.3mm Diameter	x2

001792 Rabbit Bur Kit In Block (6 Burs)
001793 Soft Tissue Protector For Above Fits Straight Nose Cone

Cylindrical Sharpening Stone



To work effectively, both scalers and elevators need to be sharp. Regular sharpening will keep your instruments working correctly.

012146 Luxator Cylindrical Sharpening Stone

Diamond Card - Fine



Diamond covered plate is ideal for sharpening dental elevators and luxators. To work efficiently these instruments must be sharp. An additional advantage is that the lubricant used is water rather than the oil used with sharpening stones.

012144 Flat Diamond Sharpening Card (Fine)

Diamond Cone



Subgingival curettes must be kept sharp to work efficiently. They should be checked and sharpened at least weekly. The diamond cone is indestructible compared with stones which break very easily and uses water rather than oil as a lubricant.

012148 Diamond Cone 205mm

Diamond Disc



001789 Diamond Disc 20mm
001791 Diamond Disc Safety Shield

General Clinical

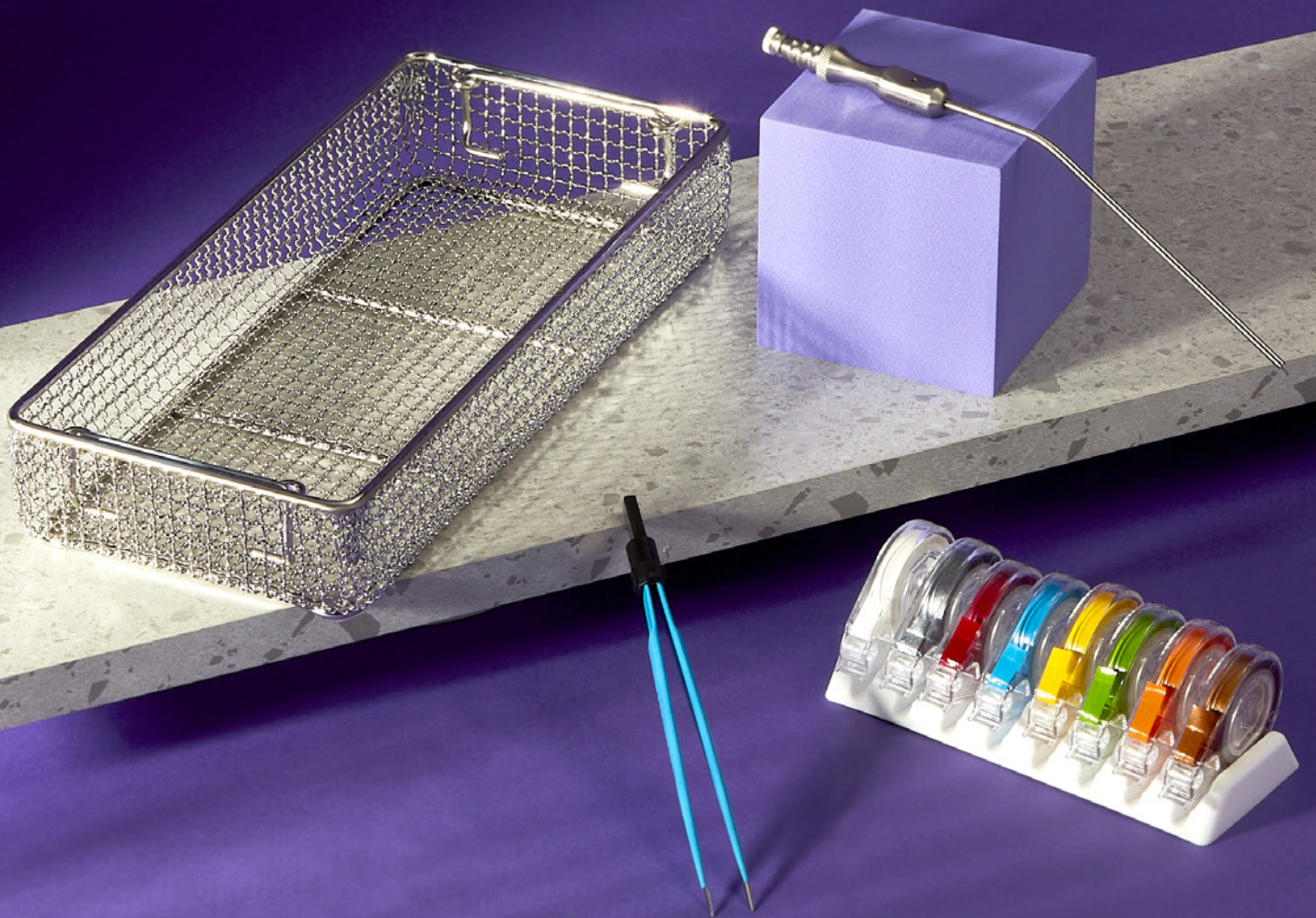

To view the General Clinical section of our website, please scan the QR code.



Modular Plating Box Components

Modular Plating Box Base & Lid



MPBB Modular Plating Box Base
MPBL Modular Plating Box Lid

Modular Plating Box Plate Trays For Locking Plates



MPBPTL15 1.5mm MPB Plate Tray For Locking Plates
MPBPTL2 2.0mm MPB Plate Tray For Locking Plates
MPBPTL24 2.4mm MPB Plate Tray For Locking Plates
MPBPTL2735 2.7/3.5mm MPB Plate Tray For Locking and Non Locking Plates

Modular Plating Box Instrument Trays



MPBIT1520 1.5/2.0mm MPB Instrument Tray
MPBIT24 2.4mm MPB Instrument Tray
MPBIT2735I 2.7/3.5mm MPB Instrument Tray 1
MPBIT27352 2.7/3.5mm MPB Instrument Tray 2
MPBIT45 4.5mm MPB Combined Instrument & Plate Tray

Modular Plating Box Screw Caddies



MPBSC15 1.5mm MPB Screw Caddy
MPBSC20 2.0mm MPB Screw Caddy
MPBSC24 2.4mm MPB Screw Caddy
MPBSC27 2.7mm MPB Screw Caddy
MPBSC35 3.5mm MPB Screw Caddy
MPBSC45 4.5mm MPB Screw Caddy

Modular Plating Box TPLO Instrument Trays

MPBITTPLO1 Instrument Tray 1 For TPLO Kits
MPBITTPLO2 Instrument Tray 2 For TPLO Kits
MPBITTPLO3 Instrument Tray 3 For TPLO Kits

Premium Boxes

Premium Boxes With No Filters



Vi's range of premium instrument boxes are made from lightweight anodised aluminium. Both lid and base are perforated, but protected by replaceable filters which allow steam penetration but not micro-organisms. The clip on lid incorporates a silicone seal which is impervious to micro-organisms.

- BX301440P** Premium Instrument Box 300x140x40mm
- BX301470P** Premium Instrument Box 300x140x70mm
- BX301410P** Premium Instrument Box 300x140x100mm

Premium Boxes With Reusable Filters



Premium Box supplied with reusable filter JK091.

- BX301440P-F** Premium Instrument Box 300x140x40mm With Filters
- BX301470P-F** Premium Instrument Box 300x140x70mm With Filters
- BX301410P-F** Premium Instrument Box 300x140x100mm With Filters

Instrument Baskets for Premium Boxes



- PBBX26512045** Instrument Basket Without Lid For BX301470P 265x120x45mm
- PBBX26011570** Instrument Basket Without Lid For BX301410P 256x120x70mm
- PBBXINNERI** Perforated Tray with Lid For BX301410P 270x123x65mm

Premium Box with Insert for Locking Kits



- LS20BOX** Premium Box With Insert For 2mm Locking Kit
- LS24BOX** Premium Box With Insert For 2.4mm Locking Kit
- LS27BOX** Premium Box With Insert For 2.7mm Locking Kit
- LS35BOX** Premium Box With Insert For 3.5mm Locking Kit

Premium Box with Insert for Cortical Kits



- BXP01** Premium Box With Insert For 1mm Cortical Kit
- BXP152024** Premium Box With Insert For 1.5/2.0/2.4mm Cortical Kit
- BXP2735** Premium Box With Insert For 2.7/3.5mm Cortical Kit

Premium Box with Insert for TTA Kit



- TTABOX** Premium Box With Insert For TTA Kit

Filters and Labels for Premium Boxes



- BXPFILTER** Paper Filter Indicators For BX3014 Series Pack of 100
- JK091** Sterile Container Reusable Filter Pack of 2
- BXPFIND** Paper Labels With Indicators Pack of 100

Disposable Padlocks with Indicator

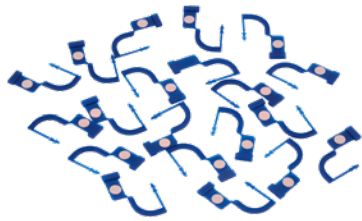

Anti-tamper security padlock with steam sterilisation indicator spot. Single use only. Padlock has to be broken to be removed.

- PSL20** Disposable Padlock With Sterilisation Pack of 20
- PSL100** Disposable Padlock With Sterilisation Pack of 100

BBraun Disposable Padlocks with Indicator



JG752 Container Padlocks with Steam Indicator Pack of 100

Disposable Padlocks - Instrument Repair



Useful for marking instruments which should be sent for repair. Single use only. Padlock has to be broken to be removed.

PSTR10 Disposable Padlocks - Instrument Repair Pack of 10

Stainless Steel Instrument Boxes with Filters



Stainless Steel in construction with a bacterial filter in the base. The Filter allows steam to enter and water vapour to leave but excludes bacteria. Available in a range of sizes to suit most instrument sets and autoclaves.

- BX201040** Instrument Box 200x100x40mm
- BX221250** Instrument Box 220x120x50mm
- BX281450** Instrument Box 280x140x50mm
- BX341650** Instrument Box 340x165x50mm
- BX341670** Instrument Box 340x165x70mm

Filters for Stainless Steel Instrument Boxes



- FILBX201040** Filter For Box BX201040
- FILBX221250** Filter For Box BX221250
- FILBX221550** Filter For Box BX221550
- FILBX281450** Filter For Box BX281450
- FILBX341650** Filter For Box BX341650

Stainless Steel Instrument Boxes without Filters



Stainless steel solid box no filter

- BX201040NF** Instrument Box No Filter 200x100x40mm
- BX221250NF** Instrument Box No Filter 220x120x50mm
- BX281410NF** Instrument Box No Filter 280x140x100mm



BX221550 Instrument Box No Filter 220x150x50mm

Silicone Inserts



Autoclavable silicone insert fits the base of the stainless box to prevent instruments contacting and damaging each other. There is an insert to fit each of our standard boxes. Colour may vary.

- BXSIL201040** Silicone Insert For Box 200x100mm
- BXSIL2540** Silicone Insert For Box 250x150mm
- BXSIL2212** Silicone Insert For Box 220x120mm
- BXSIL2215** Silicone Insert For Box 220x150mm
- PBXS270125** Silicone Insert For Box 270x125mm
- BXSIL2814** Silicone Insert For Box 280x140mm
- BXSIL3416** Silicone Insert For Box 340x160mm

Stainless Steel Box with Insert for Cortical Kits



- BX1520CS** Box Fitted For 1.5 & 2.0mm Cortical Screws & Equipment
- BX20CS** Box Fitted For 2.0mm Cortical Screws & Equipment
- BX24CS** Box Fitted For 2.4mm Cortical Screws & Equipment
- BX2735CS** Box Fitted For 2.7 & 3.5mm Cortical Screws & Equipment

Stainless Steel Box with Insert for External Fixation



001578 ESF Box With Partitions

Stainless Steel Boxes



Design may vary from image.

- BX10030** Equipment Box 100mm Wide 30mm Deep
- LSPBOX** Box For Locking Screw Plugs
- 012395** Autoclavable Case For Winged Elevators

Stainless Steel Screw Boxes

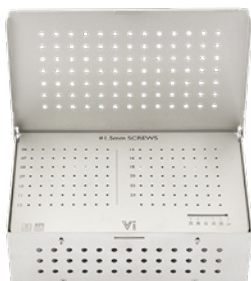

- SH1500** Screw Box For 1.5mm Screws
- SH2000** Screw Box For 2mm Screws
- SH2400** Screw Box For 2.4mm Screws
- SH2700** Screw Box For 2.7mm Screws
- SH2735** Screw Box For 2.7/3.5mm Screws
- SH3500** Screw Box For 3.5mm Screws
- SH4500** Screw Box For 4.5mm Screws
- SHTTA242735** Screw Box For TTA Screws 2.4/2.7/3.5mm

For Pin and Wire Storage See Page 129

Autoclavable Needle Boxes



- 091149** Polypropylene Needle Box 50x40x8mm
- 091149L** Polypropylene Needle Box 95x70x17mm

Power Tool Storage

Acculan 4 Storage



Can be used with Acculan 4 small drill and TPLO saw. Other storage options are available on request.

- JF282R** Basket For JN096
- JF289R** Basket Lid For JF282R
- JF938** Silicone Mat Mesh Fitting 1/2 Basket
- JN096** Dental Sterile Container & Lid

Black Series Aluminium Sterilisation Cases



Designed specifically for the Vi Black Series Drill and Saw and suitable for use in larger autoclaves. Cases outer dimensions are 300x205x70mm.

- BLACKDRILL-SC** Sterilisation Case For Black Series Drill
- BLACKSAW-SC** Sterilisation Case For Black Series Saw

Vi TPLO Saw Sterilisation Case



VITPLOSAW-SC Vi TPLO Sterilisation Case

Instrument Cleaning Agents Rapidex Cleaner



An effective general surgical instrument cleaner. The soluble sachets are simply dropped into the ultrasonic bath.

- RAPIDEX** Rapidex Soluble Sachets Box of 50
- RAPIDEXBULK** Rapidex Bulk Powder 2.25kg

Rapizyme



Easy to use measured bottle. 2ml per litre dilution.
Removes all organic material. Ideal for endoscopes and low foam for ultrasonics. Completely rinseable and biodegradable.

- RAPIZYME1** Rapizyme 1 Litre

Instrument Cleaning Brushes & Pipe Cleaners



Stainless Steel Instruments are protected from corrosion by a very thin layer of chromium oxide. This layer can be damaged by the use of brushes not designed for the purpose of cleaning surgical instruments, resulting in abrasions, surface marking and staining.

Instrument cleaning brushes are available with nylon and stainless bristles.

- CB1** Cleaning Brush Nylon For Gross Contamination
- CB2** Cleaning Brush Stainless For Large Burs & Reamers
- CB3** Cleaning Brush Nylon For General Instrumentation
- CB4** Cleaning Brush Stainless Steel For Orthopaedic Instruments
- CBPIPE** Pipe Cleaners 1/8" 12" Long Pack of 100

Cylindrical Sharpening Stone



To work effectively, both scalers and elevators need to be sharp. Regular sharpening will keep your instruments working correctly.

- 012146** Luxator Cylindrical Sharpening Stone

Diamond Card - Fine



Diamond covered plate is ideal for sharpening dental elevators and luxators. To work efficiently these instruments must be sharp. An additional advantage is that the lubricant used is water rather than the oil used with sharpening stones.

- 012144** Flat Diamond Sharpening Card (Fine)

Diamond Cone



Subgingival curettes must be kept sharp to work efficiently. They should be checked and sharpened at least weekly. The diamond cone is indestructible compared with stones which break very easily and uses water rather than oil as a lubricant.

- 012148** Diamond Cone 205mm

Instrument Marking Tape



Instrument marking tape is designed to help identify and organise instruments as they move between theatre and re-processing.

Available as a pack of 8 or in individual rolls 3000mm long.

- I00001** Instrument Marking Tape Box of 8 colours
- I00001Y** Instrument Marking Tape Single Yellow
- I00001R** Instrument Marking Tape Single Red
- I00001BR** Instrument Marking Tape Single Brown
- I00001OR** Instrument Marking Tape Single Orange
- I00001BLU** Instrument Marking Tape Single Blue
- I00001G** Instrument Marking Tape Single Green
- I00001W** Instrument Marking Tape Single White
- I00001GRY** Instrument Marking Tape Single Grey
- I00001P** Instrument Marking Tape Single Purple

Protective Autoclavable Tips



Autoclavable protective tips for pins and delicate or sharp instruments

- I00011-W** Protective Tip White Up To 1.6-2mm Diameter Pack 20
- I00011-BL** Protective Tip Blue 2.5-3mm Diameter Pack 20
- I00011-G** Protective Tip Green Up To 3.2-4mm Diameter Pack 20
- I00011-R** Protective Tip Red Up To 4.8mm Diameter Pack 20
- I00011-Y** Protective Tip Yellow Up To 6.0-6.5mm Diameter Pack 20
- I00011-O** Protective Tip Flat Orange Up To 10mm Wide Pack 20
- I00011-BR** Protective Tip Flat Brown Up To 16mm Diameter Pack 20
- I00011-BLK** Protective Tip Flat Black Up To 25mm Diameter Pack 20
- I00020** Protective Tips Silicone Multi Pack One Pack of Each Colour 160 (8x20)

Instrument Oil

- I00003** Instrument Oil Autoclavable

Skin Stapler



- STAP35W** Skin Stapler 35W Sterile Single
- STAP35W5** Skin Stapler 35W Sterile Pack of 5

Staple Remover



- STAPREM** Skin Staple Remover Single

Reusable Cotton Drapes



- BDS3624** Plain Drape Balloon Cloth 910x600mm
- BDS3624DBL** Plain Drape Balloon Cloth Double 910x600mm
- BDS3636** Plain Drape Balloon Cloth 910x910mm

Disposable Drapes



Each pack is supplied sterile and contains high quality disposable drape, hand towel, swabs, wrap and tape. Full details available upon request

- DPGENSURG** Sterile General Drape Pack
- DPORHTHO** Sterile Orthopaedic Drape Pack
- DRAPE180** TRI Laminate Drape with Adhesive Edge 180x180
- DPSPAYSM** Sterile Spay Drape Pack Small
- DPSPAYMED** Sterile Spay Drape Pack Medium
- DPSPAYLEG** Sterile Spay Drape Pack Large

Disposable Iodine Drapes



- ID6650** Ioban Drape 560x450mm - Single
- 44040** Drape, Incise, 40x40cm Iodine ADH 34x40cm - Single
- 44040/10** Drape, Incise, 40x40cm Iodine ADH 34x40cm Pack of 10
- 42020** Drape, Incise, 20x20cm Iodine ADH 15x20cm -Pack of 20

Disposable Gowns



Supplied as a single sterile high quality disposable gown with hand towel

- GPSSMALL** Sterile Surgical Gown Size S
- GPXLARGE** Sterile Surgical Gown Size XL
- GPXXLARGE** Sterile Surgical Gown Size XXL

Electrosurgery GIMA Bipolar Electrosurgery Unit 120 Watt

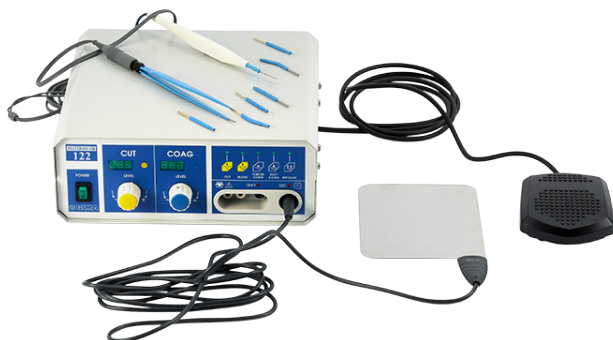

HF 122 is a high frequency electrosurgery unit suitable for micro coagulation, small and medium Monopolar surgery and bipolar coagulation. The following Monopolar modes of operation are available via the control panel: pure cutting (Cut), coagulated cutting (Coag), Monopolar coagulation and micro coagulation (Blend). Additionally with bipolar forceps, bipolar coagulation and micro coagulation are available.

Kit Includes:

- Two button Monopolar handle (autoclavable)
- Two button Monopolar handle (disposable)
- Bipolar cable and forceps
- Foot control
- Flat neutral plate
- 6 short Monopolar electrodes, as pictured below.

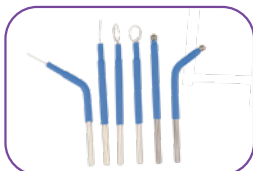

- HF122** 120 Watt Monopolar/ Bipolar Electrosurgery Unit
- HF30547** Spare Monopolar Handle Screw Grip For HF122
- HF123** Imm Bipolar Dissecting Forceps 180mm Str F/HF122
- HF124** Spare Bipolar Cable For HF122 (A Type)
- HF30568** Spare Foot Pedal For HF122

GIMA Bipolar Electrosurgery Unit 160 Watt



This unit is a higher-powered version of our popular HF 122 Unit. The additional power availability comes into its own when working with mixed tissue densities such as in orthopaedics, and in more moist situations such as mucous membranes.

Modes of operation are pure cut, coagulated cut, forced coagulation, soft coagulation, and with bipolar forceps, bipolar coagulation.

HF160 has the same set of alarms as the 120, including open circuit which warns of a disconnected cable or poor patient plate contact and interrupts the HF emission for cut and coagulation.

All the standard accessories shown for the HF120 fit this unit. We can also supply an adaptor which allows standard 2 x 4mm banana plug (Valley Lab type) bipolar cables to be used with HF 160.

- HF160** 160 Watt Monopolar/Bipolar Electrosurgery Unit
- HF30642** Bipolar Cable Adaptor For Gima Unit HF160 to 2x4mm Banana Plugs

Bipolar Dissecting Forceps

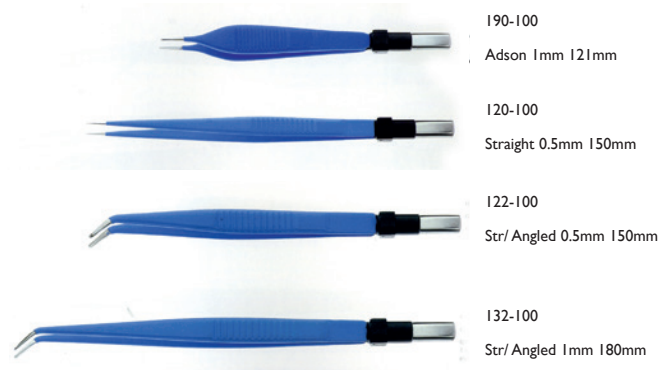

- HF190-100** Bipolar Forceps Adson 1mm Tip 121mm Long
- HF120-100** Bipolar Forceps Straight 0.5mm Tip 150mm Long
- HF122-100** Bipolar Forceps Straight/Angled 0.5mm Tip 150mm Long
- HF132-100** Bipolar Forceps Straight/Angled 1mm Tip 180mm Long

Bipolar Cable Generator Terminations



A
GIMA HF122

D
4mm Banana Plugs
Valley Lab
Eschman
Arthrex OPES

These are the most common types of termination for the generator or machine end of the cable.

Our bipolar cables and forceps all have an EU fitting square end.

- HF124** Spare Bipolar Cable A Type EU Fitting Forceps Connector
- HFS-30** Spare Bipolar Cable D Type EU Fitting Forceps Connector
- HF30642** Bipolar Cable Adaptor

Monopolar Spares and Accessories

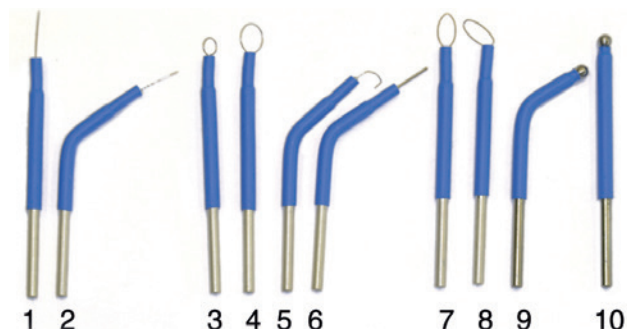

- HF1** Electrode
- HF2** Electrode
- HF3** Electrode
- HF4** Electrode
- HF5** Electrode
- HF6** Electrode
- HF7** Electrode
- HF9** Electrode
- HF10** Electrode
- HF1-10** Electrodes Mixed Set of 10
- HF12** 7cm Blade - Autoclavable



HF30537 Scratch Pad (Supplied Sterile) Pack of 10



- HF30547** Spare Monopolar Handle Screw/Grip For HF122
- HF30563** Spare Cable For Gima Plate
- HF126** Spare Metal Plate For HF122 and HF106
- HF107** Autoclavable Monopolar Handle for HF106

GIMA Smoke Evacuation Unit



The surgical smoke consists of water vapour, organic gas, visible or invisible solid particles and viral particles. The aspiration and filtration system eliminates bad smells, reduces the bacteriological and viral risks, whilst improving vision in the surgical field.

The Smoke Evacuation Starter Kit contains:

- HF30450** Electrosurgery Smoke Evacuation Unit x1
- HF30451** Smoke Evacuation ULPA Red Filter 20 hours x1
- HF30453** Aspiration Kit Pack of 6 x1
- HF30454** Handle Aspiration Kit Sterile Pack of 12 x1
- HF30578** GIMA Waterproof Foot Pedal 3m Cable x1

Kit components are available separately.

- HF30540START** Smoke Evacuation Starter Kit

Portable Cordless Cautery Kit



This handy set comprises a handpiece using two AA batteries (included) and four interchangeable and replaceable Cautery Tips

- 1/2"(12mm) Fine general purpose electrode for haemostasis
- 1/2"(12mm) Loop electrode for small skin tumours
- 4"(130mm) Fine electrode for deep areas
- 4"(130mm) Loop electrode

Tip temperature 2200°F/1200°C

- 02313** Portable Cordless Cautery Kit
- 02313W** Replacement Cautery Tip 1/2" Fine
- 02313X** Replacement Cautery Tip 1/2" Loop
- 02313Y** Replacement Cautery Tip 4" Fine
- 02313Z** Replacement Cautery Tip 4" Loop

Askir Suction Machine



A simple suction unit with a 1 litre capacity bottle, which is adequate for virtually all small animal procedures. The in-line filtration system minimises biohazards.

- 185000** ASKIR 30 Suction Device
- 185002** Tube Set and Filter for Suction Machine
- 185003** Filter Only
- 185004** Spare Suction Bottle and Lid
- 185005** Spare Lid for Suction Bottle

Suction Tubing



- 185009** Autoclavable Suction Tubing Per Metre

Suction Tubing Connector



- 185006** Suction Tubing Connector

Hospivac Spares

- 185H210351** Spare 2L Bottle With Lid For Hospivac 350
- 185H210353** Spare 2L Bottle Without Lid For Hospivac 350
- 185HSP0032** Spare Tubes and Filter For Hospivac 350
- 185HSP0121** Spare Filter For Hospivac 350
- 185HSP033** Spare Tubes For Hospivac 350

Suction Tips

We stock the four most useful styles of tip. Each comes complete with a 2 metre length of autoclavable silicone tubing to connect to the suction unit.

Yankauer



General purpose suction tip for removal of large volumes e.g. from abdomen.

- 1854327** Yankauer Suction Tip

Poole



As Yankauer but more holes for greater volume uptake. With perforated outer sheath removed the Poole functions as a small bore straight suction tip.

- 1854330** Poole Suction Tip

Adson 4mm



Focal suction tip removes fluid from specific locations e.g. in spinal procedures. Very controllable at the handpiece by single finger over air bypass hole.

- 1852121** Adson Suction Tip 4.0mm

Frazier 2.6mm



As the Adson but finer still.

- 1854328** Frazier Suction Tip 2.6mm

Patient Warming & Monitoring



To view the Patient Warming & Monitoring section of our website, please scan the QR code.



AAS Darvall Warm Air System

The benefits of preventing hypothermia both during and after surgery are well documented, both in terms of improved patient care and more efficient use of resources.

Use of warm air blankets to pre-warm patients, heated anaesthetic circuits for all procedures plus blankets under anaesthetised animals during longer procedures, over 60 minutes, followed by post-op cage blanket use will help optimise patient recovery from anaesthesia.

AAS Darvall Cozy Warm Air Heater



The Darvall Cozy™ Warm Air Heater is easy and straightforward to use. Running quietly, it is suitable for use both in theatres and recovery areas. The Darvall Cozy™ Warm Air Heater comes with a 24 month warranty.

The Darvall Cozy™ Starter Kit contains:

- Darvall Cozy™ Warm Air Heater Unit
- Wheel Kit - 4 Push Fit Wheels
- Sample Pack of 8 Blankets
- Kennel Door Adaptor Cwik

AAS9084 AAS Darvall Cozy™ Warm Air Heater System

AAS Darvall Kennel Door Adapter

The KDA Kennel Door Adapter Cwik:

- Connects Darvall Cozy Warm Air Heater to Darvall's Kennel Blankets
- Fits to most warm air heaters using Cozy KDA Heater Hose Adapter
- Cozy Cwik™ locking system - no nuts or screws
- Twist-Connect system for easy installation
- Allows fast access to patients in kennels
- Rapidly moved between kennel doors
- Fits to most kennel door systems
- Safe warming for patients

The KDA Kennel Door Adapter Cwik Kit contains:

- 1x Cozy Cwik KDA Adapter
- 2x Cozy Cwik KDA Gaskets (1 spare)
- 1x Cozy KDA Extension Hose 25cm
- 1x Cozy KDA Universal Heater Hose Adapter
- 1x Cozy Blanket x 8 Sample Pack

AAS9842 Darvall KDA Kennel Door Adapter Kit - Cwik

AAS Darvall Warm Air Blankets - New Range

Innovative Warm Air Blankets for surgery, dentistry, exotics and kennels. Use for pre-warming, during anaesthesia and in recovery.

What makes them different from the rest?

The Darvall series of warm air blankets are specifically designed for veterinary use. The unique blanket surface design is porous polyester which provides low uniformly-distributed air flow, providing efficient warming, reducing the 'wind chill' factor and minimising hair contamination. Traditional warm air blankets have a punched out surface allowing a higher rate of air flow out of the blanket, much less suitable for veterinary patients.

The blankets are colour coded, the white side always is in contact with the patient.

AAS Darvall Warm Air System Blankets

- AAS02979** Darvall Warm Air Surgery Under Blanket for Cats and Small Dogs - Pack of 10
- AAS02275** Darvall Warm Air Surgery Under Blanket For Medium and Large Dogs - Pack of 10
- AAS05310** Darvall Warm Air Dentistry Under Blanket/Surgery Over Blanket For Medium and Large Dogs - Pack of 10
- AAS02827** Darvall Warm Air Surgery/Cage Blanket For Exotics and Small Animals - Pack of 10
- AAS05360** Darvall Warm Air Single Kennel Blanket For Cats and Small Dogs - Pack of 10
- AAS05359** Darvall Warm Air Double Kennel Blanket For Medium and Large Dogs - Pack of 10
- AAS8460** Darvall Warm Air Sample Assorted Blankets - Pack of 10 (2 x 2979, 2 x 2275, 2 x 5360, 2 x 5359, 1 x 5310, 1 x 2827)

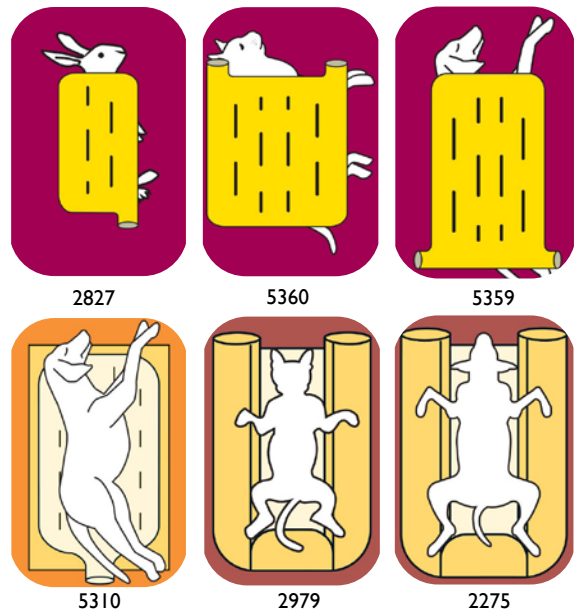

AAS Darvall Cozy Warm Air Heater Accessories

- AAS9744** AAS Darvall Cozy™ Filter Replacement Kit
- AAS9707** AAS Darvall Cozy™ Heater Hose Cover
- AAS9702** AAS Darvall Cozy™ Heater Hose (3-Pin Connector V1.0)
- AAS9979** AAS Darvall Cozy™ Heater Hose (4-Pin Connector V1.1)
- AAS1959** Darvall Two Kennel Y Adaptor (Requires 2x AAS9842 - Not Included)
- AAS9701** AAS Darvall Cozy™ KDA Extension Hose 1.5m
- AAS8130** AAS Darvall Cozy™ KDA Extension Hose 25cm
- AAS8577** AAS Darvall Cozy™ KDA Universal Heater Hose Adapter
- AAS9737** AAS Darvall Cozy™ Elbow Adapter (3-Pin Connector V1.0)
- AAS9981** AAS Darvall Cozy™ Elbow Adapter (4-Pin Connector V1.1)
- AAS9742** AAS Darvall Warm Air Heater Hose Clamp

The Darvall Cozy™ Warm Air Heater Hose comes with a 12 month warranty.

Darvall Heated Anaesthetic Starter Kit and Accessories



- AAS9855** Heated Circuits Starter Kit Complete With Lack Adapter
- AAS8347** Heated Smooth Wall Breathing Circuit 12mm Cats and Small Dogs 2-20kg
- AAS8348** Heated Smooth-Wall Breathing Circuit 16mm For Dogs 30-80kg
- AAS8617** Heat Controller Temperature Probe Outside Diameter 2.5mm for Exotics and Birds
- AAS8618** Heat Controller Temperature Probe Outside Diameter 3.6mm For Cats, Dogs and Rabbits
- AAS8615** Heated Circuit Connection Cable (Spare Part)
- AAS10104** Protective Cover for Breathing Circuits and ETCO₂ Sensor

Darvall Express Monitor



Rugged monitor designed to automatically commence operation by simply pushing the power button and connecting two sensors. Comes complete with Nellcor SpO₂, Suntech NIBP hose temperature probe and DOC-10 extension cable.

Features:

- Nellcor™ pulse oximetry
- Darvall minimal dead space capnography
- Darvall body temperature probe
- Suntech veterinary non-invasive blood pressure (NIBP)
- Single one touch quick set button
- Default system set-up for cats and small dogs
- Darvall's innovative conforming NIBP cuffs covering seven sizes, for all small animals
- Easy to see colour-coded display
- Red – Heart rate and O₂. Blue – blood pressure. Green – body temperature
- Long battery life

- AAS9624** Darvall Express Monitor
- AAS9969** Pole Mount Bracket for Darvall Express

Replacement parts for Darvall Express:

- AAS9857** NIBP Hose 2.5m Long for Darvall Express
- AAS9204** Oesophageal/Rectal Temp Probe for Darvall Express
- AAS8811** Nellcor Extension Cable DOC-10 for Darvall Express
- AAS10016** 1 GB Storage Card for IRIS use for Darvall Express
- AAS10104** Protective Cover for Breathing Circuits and ETCO₂ Sensor

Darvall Capnograph



The Darvall Capnograph continuously measures the EtCO₂ and respiratory rate, and features EtCO₂ waveform Cardiac Oscillation artifact detection for correct respiratory rate determination. It is a reliable and accurate way of monitoring depth of anaesthesia. Only suitable for Darvall Express.

Features:

- Rugged, low-cost sensor
- Fast, sensitive sensor, for better performance in small animals
- Mainstream capnography avoids waste gasses
- Ideal for low-flow low-emission environmentally friendly anaesthesia
- Waveform Cardiac Oscillation artifact detection for correct respiratory rate determination

- AAS9627** Mainstream ETCO₂ Sensor for Darvall Express
- AAS2120** Paediatric Mainstream Airway Adapter - (Purple)
- AAS2121** Adult Mainstream Airway Adapter - (Clear)

Sidestream is also available and only suitable for Darvall Express

- AAS9965** Sidestream ETCO₂ Sensor for Darvall Express
- AAS10112** Sampling Line for Sidestream CO₂

Darvall Veterinary Blood Pressure Cuffs



NIBP small animal cuffs are designed for accurate pressure detection in exotics, cats and all sizes of dog. The wide Velcro tabs provide secure conformation to the limb, with resilient but tactile silicon for reliable accurate signal transduction and validated pressure detection, including in conscious animals. Seven sizes for all small animals.

- AAS9890** Darvall NIBP Cuff Size 0. Limb Circumference 3.5cm - 6.5cm
- AAS9891** Darvall NIBP Cuff Size 1. Limb Circumference 5cm - 7.5cm
- AAS9892** Darvall NIBP Cuff Size 2. Limb Circumference 6cm - 8.5cm
- AAS9898** Darvall NIBP Cuff Size C. Limb Circumference 7cm - 10cm (Cat Size)
- AAS9893** Darvall NIBP Cuff Size 3. Limb Circumference 8.5cm - 11cm
- AAS9894** Darvall NIBP Cuff Size 4. Limb Circumference 10cm - 14cm
- AAS9896** Darvall NIBP Cuff Size 5. Limb Circumference 12cm - 16cm
- AAS9898** Darvall NIBP Cuff Size 8. Limb Circumference 14cm - 22cm
- AAS10042** Darvall NIBP Cuff Size 10. Limb Circumference 20cm - 29cm
- AAS10043** Darvall NIBP Cuff Size 13. Limb Circumference 27cm - 37cm
- AAS9895** Darvall NIBP Cuff Set. Sizes 0-5 and C (7 Cuffs)
- AAS10012** Darvall NIBP Vet-Cuff Range Circumference Measuring Strip

Replacement parts for Darvall H100N and Darvall Express:

- AAS9897** NIBP Adapter Hose Bayonet to Luer for Darvall Cuffs
- AAS8062** Darvall O₂-SAT Nellcor Vet Sensor for H100N and Darvall Express Monitor
- AAS8208** Darvall Nellcor Sensor Clip for Small Animal

Darvall HI00N Pulse Oximeter and Temperature Monitor



Convenient and reliable handheld pulse oximetry and temperature monitor; embedded with world leading Nellcor OxiMax™ pulse oximetry technology.

Features:

- Nellcor OxiMax™ pulse detection
- Temperature channel for rapid check
- LCD display with backlight control
- Automatic power-off function for power saving
- Comes complete with SpO₂ sensor, temperature sensor and protective rubber boot.

AAS539I Darvall HI00N Pulse Oximeter and Temperature Monitor

The monitor can be used with either 4 x AA batteries for up to 48 hours of work or a rechargeable battery for up to 30 hours of work.

AAS8049 Charger Dock and 1 x Ni-MH Battery for HI00N Pulse Oximeter

AAS8175 Ni-MH Battery for HI00N Pulse Oximeter

Replacement parts for Darvall HI00N Pulse Oximeter and Temperature Monitor

AAS7870 Rectal/Oral Temperature Probe for HI00N Pulse Oximeter



Loan Kits

For a nominal fee, we have a range of **specialist loan kits** available to complement your own fleet. With next working day availability, the service offers flexibility as procedures are booked with your clients.

To find out more, scan the QR code below.



Rehabilitation



To view the Rehabilitation section of our website, please scan the QR code.



Scandi Orthopedics

Scandi Orthopedic Carpal Orthotics

Different Grades (1 - 3) will allow individual cases to get the correct support for the joint.

Available in the following new sizes:

- SCA-31078-3130 Carpal Grade 1 XS UNIV
- SCA-31079-3140 Carpal Grade 1 S UNIV
- SCA-31080-3150 Carpal Grade 1 M UNIV
- SCA-31081-3160 Carpal Grade 1 L UNIV
- SCA-31077-3170 Carpal Grade 1 XL UNIV



- SCA-32200-3130 Carpal Grade 2 XS UNIV
- SCA-32201-3140 Carpal Grade 2 S UNIV
- SCA-32202-3150 Carpal Grade 2 M UNIV
- SCA-32203-3160 Carpal Grade 2 L UNIV
- SCA-32204-3170 Carpal Grade 2 XL UNIV

- SCA-35078-3130 Carpal Grade 2.5 XS UNIV
- SCA-35079-3140 Carpal Grade 2.5 S UNIV
- SCA-35080-3150 Carpal Grade 2.5 M UNIV
- SCA-35081-3160 Carpal Grade 2.5 L UNIV
- SCA-35077-3170 Carpal Grade 2.5 XL UNIV

- SCA-33001-3131 Carpal Grade 3 with Paw XS UNI
- SCA-33001-3141 Carpal Grade 3 with Paw S UNI
- SCA-33001-3151 Carpal Grade 3 with Paw M UNI
- SCA-33001-3161 Carpal Grade 3 with Paw L UNI
- SCA-33001-3171 Carpal Grade 3 with Paw XL UNI

- SCA-33441-3131 Carpal Grade 3+ XS UNI
- SCA-33441-3141 Carpal Grade 3+ S UNI
- SCA-33441-3151 Carpal Grade 3+ M UNI
- SCA-33441-3161 Carpal Grade 3+ L UNI
- SCA-33441-3171 Carpal Grade 3+ XL UNI

Scandi Orthopedic Tarsal Orthotics

Different Grades (1 - 3) will allow individual cases to get the correct support for the joint.

Available in the following new sizes:

- SCA-71081-3130 Tarsal Grade 1 XS UNIV
- SCA-71083-3140 Tarsal Grade 1 S UNIV
- SCA-71084-3150 Tarsal Grade 1 M UNIV
- SCA-71085-3160 Tarsal Grade 1 L UNIV
- SCA-71082-3170 Tarsal Grade 1 XL UNIV



- SCA-72081-3130 Tarsal Grade 2 XS UNIV
- SCA-72021-3140 Tarsal Grade 2 S UNI
- SCA-72022-3150 Tarsal Grade 2 M UNI
- SCA-72023-3160 Tarsal Grade 2 L UNI
- SCA-72024-3170 Tarsal Grade 2 XL UNIV

- SCA-75081-3130 Tarsal Grade 2.5 XS UNIV
- SCA-75083-3140 Tarsal Grade 2.5 S UNIV
- SCA-75084-3150 Tarsal Grade 2.5 M UNIV
- SCA-75085-3160 Tarsal Grade 2.5 L UNIV
- SCA-75082-3170 Tarsal Grade 2.5 XL UNIV

- SCA-73001-3131 Tarsal Grade 3 with Paw XS UNI
- SCA-73001-3141 Tarsal Grade 3 with Paw S UNI
- SCA-73001-3151 Tarsal Grade 3 with Paw M UNI
- SCA-73001-3161 Tarsal Grade 3 with Paw L UNI
- SCA-73001-3171 Tarsal Grade 3 with Paw XL UNI

- SCA-73441-3131 Tarsal Grade 3+ XS UNI
- SCA-73441-3141 Tarsal Grade 3+ S UNI
- SCA-73441-3151 Tarsal Grade 3+ M UNI
- SCA-73441-3161 Tarsal Grade 3+ L UNI
- SCA-73441-3171 Tarsal Grade 3+ XL UNI

Levels of leg injury treatment

		GRADE 1	GRADE 2	GRADE 2.5	GRADE 3	GRADE 4
Tendons/ligaments	Light	●	●●	●●●		
	Medium		●●● + ●	●●●●	●●●●	
	Severe				●●●●	●●●●●●
Fracture					●●●●	●●●●●●
Pareses	Light		●●	●●●		
	Severe					●●●●●●
Postoperative		●	●●	●●●	●●●●	●●●●●●
Arthrosis	Light	●	●●			
	Medium			●●●	●●●●	
	Severe					●●●●●●

GRADE 1 ●
Light and flexible support to reduce pain and inflammation. Prevents re-injury. Classic neoprene orthosis for light injuries.

GRADE 2 ●●
Provides light to medium support and pain reduction while allowing some movement. Uses adjustable Velcro stabilising straps.

GRADE 2.5 ●●●
Semi-rigid support that stabilises the joint. Ideal for medium tendon/ligament injury and medium arthrosis. Uses thermoplastic.

GRADE 3 ●●●●
Rigid support with thermoplastics that immobilises the injured area. Re-shapeable. For medium to severe injuries.

GRADE 4 ●●●●●●
Rigid external support that allows desired movement. Adjustable mobility and support. Made from 3D-scan.

● As complement after plaster treatment.

NOTE! Phalanges with osteoarthritis always require Grade 3 with Paw or Grade 4 with Paw included, since stabilisation of the paw is required.

Scandi Orthopedic Cold Compression Therapy Bandage

Cooling bandage for pets and provides cold relief for up to three hours. Does not need to be pre-cooled before use. Cold Compression Therapy (CCT) is scientifically proven to be effective.

- No need for pre-cooling
- Self adhesive
- Reduces swelling and pain
- Non-sterile
- Can be used postoperative

SCA-81163-3160 Cold Compression Therapy-CCT Large (8 Pcs/Box)

SCA-81162-3250 Cold Compression Therapy-CCT Medium (8 Pcs/Box)



Scandi Orthopedic Helping Hand Pet Lift Sling

From standard to comfort and offload, there is a variety of options available.

SCA-81174-3150 Helping Hand Standard Medium 86cm

SCA-81175-3160 Helping Hand Standard Large 116cm



SCA-81176-3150 Helping Hand Comfort Medium 86cm

SCA-81177-3160 Helping Hand Comfort Large 116cm



SCA-82168-3130 Helping Hand Offloading Harness XS

SCA-82169-3140 Helping Hand Offloading Harness S

SCA-82170-3150 Helping Hand Offloading Harness M

SCA-82171-3160 Helping Hand Offloading Harness L

SCA-82172-3170 Helping Hand Offloading Harness XL



Scandi Orthopedic Rain Cover

A waterproof rain cover sleeve and secured with elastic bands.

SCA-41345-3130 Raincover Carpal Size XS

SCA-41345-3140 Raincover Carpal Size S

SCA-41345-3150 Raincover Carpal Size M

SCA-41345-3160 Raincover Carpal Size L

SCA-41345-3170 Raincover Carpal Size XL

SCA-71345-3130 Raincover Tarsal Size XS

SCA-71345-3140 Raincover Tarsal Size S

SCA-71345-3150 Raincover Tarsal Size M

SCA-71345-3160 Raincover Tarsal Size L

SCA-71345-3170 Raincover Tarsal Size XL



Scandi Orthopedic Medical Protection Cover

ScandiTex - combines durability and water resistance with stretch and breathable properties.

SCA-91129-3110 MPC Front Leg Universal Size XXXS

SCA-91130-3120 MPC Front Leg Universal Size XXS

SCA-91131-3130 MPC Front Leg Universal Size XS

SCA-91132-3140 MPC Front Leg Universal Size S

SCA-91133-3150 MPC Front Leg Universal Size M

SCA-91134-3160 MPC Front Leg Universal Size L

SCA-91135-3170 MPC Front Leg Universal Size XL



SCA-91202-1189 MPC Hind Leg Left Size 4XS

SCA-91136-1110 MPC Hind Leg Left Size XXXS

SCA-91137-1120 MPC Hind Leg Left Size XXS

SCA-91138-1130 MPC Hind Leg Left Size XS

SCA-91139-1140 MPC Hind Leg Left Size S

SCA-91140-1150 MPC Hind Leg Left Size M

SCA-91141-1160 MPC Hind Leg Left Size L

SCA-91142-1170 MPC Hind Leg Left Size XL



SCA-91202-2188 MPC Hind Leg Right Size 4XS

SCA-91143-2110 MPC Hind Leg Right Size XXXS

SCA-91144-2120 MPC Hind Leg Right Size XXS

SCA-91145-2130 MPC Hind Leg Right Size XS

SCA-91146-2140 MPC Hind Leg Right Size S

SCA-91147-2150 MPC Hind Leg Right Size M

SCA-91148-2160 MPC Hind Leg Right Size L

SCA-91149-2170 MPC Hind Leg Right Size XL

SCA-91201-1148 MPC Hind Leg Wide Left Size S

SCA-91201-2149 MPC Hind Leg Wide Right Size S

ScandiTex® – our durable fabric

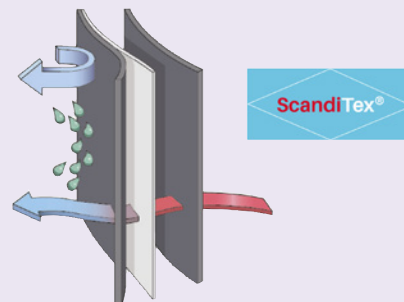

After years of research we can now proudly present our new fabric. ScandiTex® is a fabric that combines durability and water resistance with stretchy and breathable properties. This makes it perfect for animals that need to visit the outdoors but still need protection from the weather and also serves the purpose of preventing the animal from licking the wound.

The ScandiTex® fabric is utilised in our new Medical Protection Cover product range, where it is sewn without seams on the inside to maximise comfort. We also use ScandiTex® in the weather covers that comes with our Grade 3 leg orthoses.



Dressing and Support

Thera-Paw



Thera-Paw acts as a reusable bandage with a protective base.

Key Thera-Paw Features:

- Ultra-cushioned sole alleviates pain, reducing lameness and promoting more even weight distribution
- Use of perforated top-sole material and cut-out design allow the paw to breathe and keeps the injured site free from moisture build-up
- Rubberised, non-skid base and toe-cap are waterproof, protect the site from further injury, and provide better traction
- Vertical closure design runs parallel to the carpal/tarsal bones, dispersing pressure over a wide area
- Thera-Paw is easily cleaned by rinsing it under warm water. Mild detergent may be used. It air dries in under 1 hour, and is ready for immediate reapplication
- Front opening and closing mechanism makes it easy to slip Thera-paw into place
- Outer safety strap provides additional security, to ensure that Thera-paw stays on even the most active dogs
- Dual closing mechanism reduces the risk that a dog can remove the garment

200002	Thera-Paw Small (T/B)
200003	Thera-Paw Small/ Medium (T/C)
200003#2	Thera-Paw Small/ Medium#2 (T/D)
200004	Thera-Paw Medium (T/E)
200005	Thera-Paw Medium/ Large (T/F)
200006	Thera-Paw Large (T/G)
2000SET	Thera-Paw Set of 6 (As above)

Medipaw® Protective Boot



A professional waterproof but breathable cover for dressings and casts. Available in colour coded sizes, they have a durable non-skid base, and elasticised straps with Velcro closures as well as an upper cord lock.

Hard Sole Medipaw

200015	Medipaw Boot Hard Sole Extra Small Wide (XSW) - Orange
200020	Medipaw Boot Hard Sole Extra Small - Yellow
200031	Medipaw Boot Hard Sole Extra Small #2 - Pink
200025	Medipaw Boot Hard Sole Small - Blue
200030	Medipaw Boot Hard Sole Medium - Red
200035	Medipaw Boot Hard Sole Large - Green
200037	Medipaw Boot Hard Sole Large Wide - Grey
200040	Medipaw Boot Hard Sole Extra Large - Purple
200091SET	Medipaw Boot Hard Sole Set of 5 - XS, S, M, L, XSW

Soft Sole Medipaw

200097	Medipaw Boot Soft Sole Extra Small Wide (XSW)- Orange
200093	Medipaw Boot Soft Sole Extra Small - Yellow
200092	Medipaw Boot Soft Sole Extra Small #2 - Pink
200094	Medipaw Boot Soft Sole Small - Blue
200095	Medipaw Boot Soft Sole Medium - Red
200096	Medipaw Boot Soft Sole Large - Green
200099	Medipaw Boot Soft Sole Large Wide - Grey
200098	Medipaw Boot Soft Sole Extra Large - Purple
200090SET	Medipaw Boot Soft Sole Set of 5 - XS, S, M, L, XSW

Medipaw® Slim Boot



Superior open-wound healing for dogs and cats. Medipaw® Slim — the protective veterinary boot with a soft, antimicrobial bamboo and silver lining. Indicated for dog and cat open-wound treatment:

MDS-XS	Medipaw Slim Boot Extra Small - Yellow
MDS-S	Medipaw Slim Boot Small - Blue
MDS-M	Medipaw Slim Boot Medium - Red
MDS-L	Medipaw Slim Boot Large - Green
MDS-XL	Medipaw Slim Boot Extra Large - Purple
MDS-STR	Medipaw Slim Boot Starter Pack Set of 3 - S, M, L

Carp Flex Range

Carp Flex are a range of supports designed to stabilise the carpus.

Carp Flex Sports Wrap Light Support

200011L	Carp Flex Sports Wrap XS Green Left
200011R	Carp Flex Sports Wrap XS Green Right
200012L	Carp Flex Sports Wrap S Red Left
200012R	Carp Flex Sports Wrap S Red Right
200013L	Carp Flex Sports Wrap M Blue Left
200013R	Carp Flex Sports Wrap M Blue Right
200014L	Carp Flex Sports Wrap L Black Left
200014R	Carp Flex Sports Wrap L Black Right

Carp Flex X Moderate Support

200070L	Carp Flex X Wrap XS Left
200070R	Carp Flex X Wrap XS Right
200071L	Carp Flex X Wrap S Left
200071R	Carp Flex X Wrap S Right
200072L	Carp Flex X Wrap M Left
200072R	Carp Flex X Wrap M Right
200073L	Carp Flex X Wrap L Left
200073R	Carp Flex X Wrap L Right
200074L	Carp Flex X Wrap XL Left
200074R	Carp Flex X Wrap XL Right

Carp Flex Splint Kit Strong Support

200060L	Carp Flex Splint Kit XS Left
200060R	Carp Flex Splint Kit XS Right
200061L	Carp Flex Splint Kit S Left
200061R	Carp Flex Splint Kit S Right
200062L	Carp Flex Splint Kit M Left
200062R	Carp Flex Splint Kit M Right
200063L	Carp Flex Splint Kit L Left
200063R	Carp Flex Splint Kit L Right
200064L	Carp Flex Splint Kit XL Left
200064R	Carp Flex Splint Kit XL Right

Tarso-Flex X

Tarso-Flex X offers moderate tarsal support.

200100XSL	Tarso Flex X - XS Left
200100XSR	Tarso Flex X - XS Right
200100SR	Tarso Flex X - Small Right
200100SL	Tarso Flex X - Small Left
200100MR	Tarso Flex X - Medium Right
200100ML	Tarso Flex X - Medium Left
200100LR	Tarso Flex X - Large Right
200100LL	Tarso Flex X - Large Left
200100XLL	Tarso Flex X - XL Left
200100XLR	Tarso Flex X - XL Right

Dorsi-Flex Assist

Dorsi-Flex Assist is used to aid the normal placement of the hind limb.

200018	Dorsi Flex Assist Therapaw and Tibial Wrap TB XXS
200019	Dorsi Flex Assist Therapaw and Tibial Wrap TC XS
200022	Dorsi Flex Assist Therapaw and Tibial Wrap TE M
200023	Dorsi Flex Assist Therapaw and Tibial Wrap TF L
200024	Dorsi Flex Assist Therapaw and Tibial Wrap TG XL

Padded Splints

Made from green foam lined plastic.

090120	Padded Splint Small 210mm
090121	Padded Splint Medium 310mm
090122	Padded Splint Large 410mm

Thermoplastic Splinting

The white sheet of Thermoplastic splint is heated in hot water and moulded to a specific custom shape for the patient.



940A	Marq Easy Thermoplastic Splinting Sheet 100x220mm
940B	Marq Easy Thermoplastic Splinting Sheet 152x300mm
940C	Marq Easy Thermoplastic Splinting Sheet 300x600mm
940V	Velcro Strap Hook For Thermoplastic Splints
940X	Compact Blue Foam Sheet For Thermoplastic Splints 400x600mm
940KIT	Thermoplastic Splinting Starter Kit. Contains 940A, 940B, 940X & 940V

Plate Profiles

To access the digital plate profiles featured in this chapter, please email info@vetinst.com



1.5mm Compression Plates

- CI51674
- CI51465
- CI51256
- CI51152
- CI51047
- CI50943
- CI50838
- CI50734
- CI50629
- CI50525
- CI50420

2.0mm Mini Plates

- MP20317
- MP20423
- MP20529
- MP20635
- MP20741

2.0mm Compression

- CP201892
- CP201682
- CP201472
- CP201262
- CP201052
- CP20842
- CP20737
- CP20632
- CP20527
- CP20422

2.0mm Round Hole Plates

- PR200843
- PR200840
- PR200738
- PR200633
- PR200630
- PR200528
- PR200423
- PR200213

2.0mm Biological Healing Plates

- BHP2008080
- BHP2008075
- BHP2008070
- BHP2008065
- BHP2007060

2.0mm ASYM® Plates

- ASYM20030437
- ASYM20030542
- ASYM20030647
- ASYM20030752
- ASYM20040652
- ASYM20030857



2.4mm Compression Plates

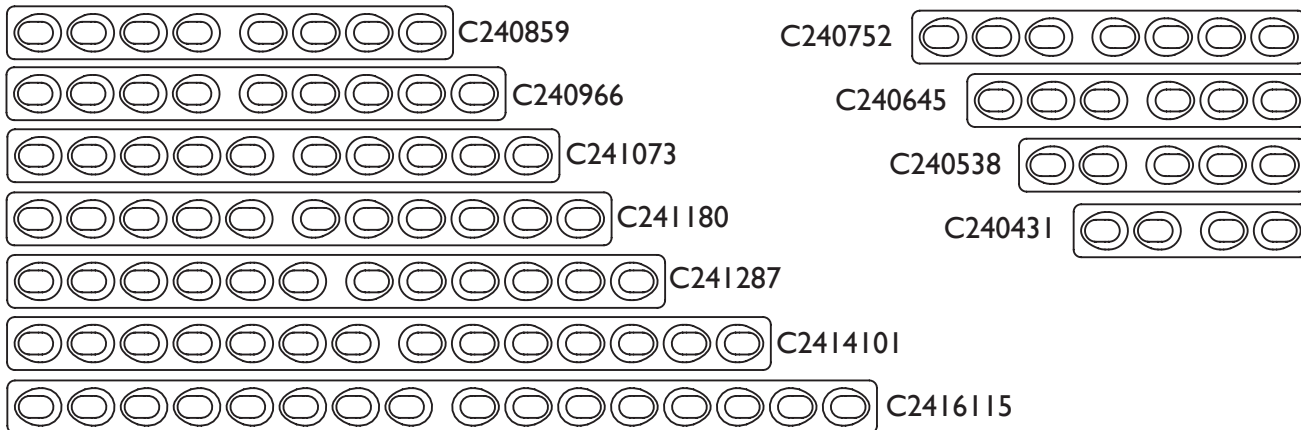

2.4mm ASYM[®] Plates

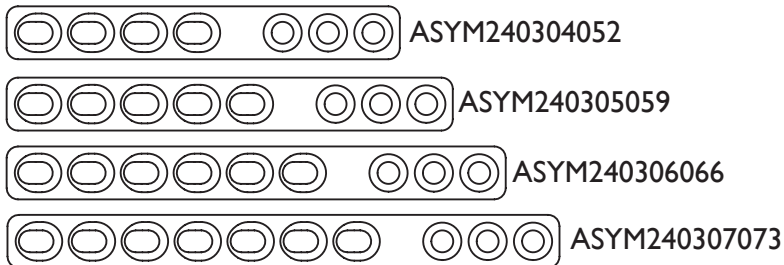

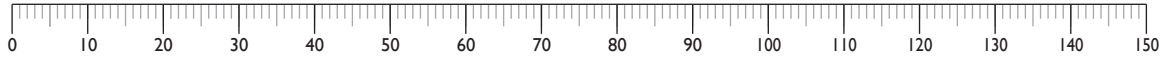

2.7mm Compression Plates

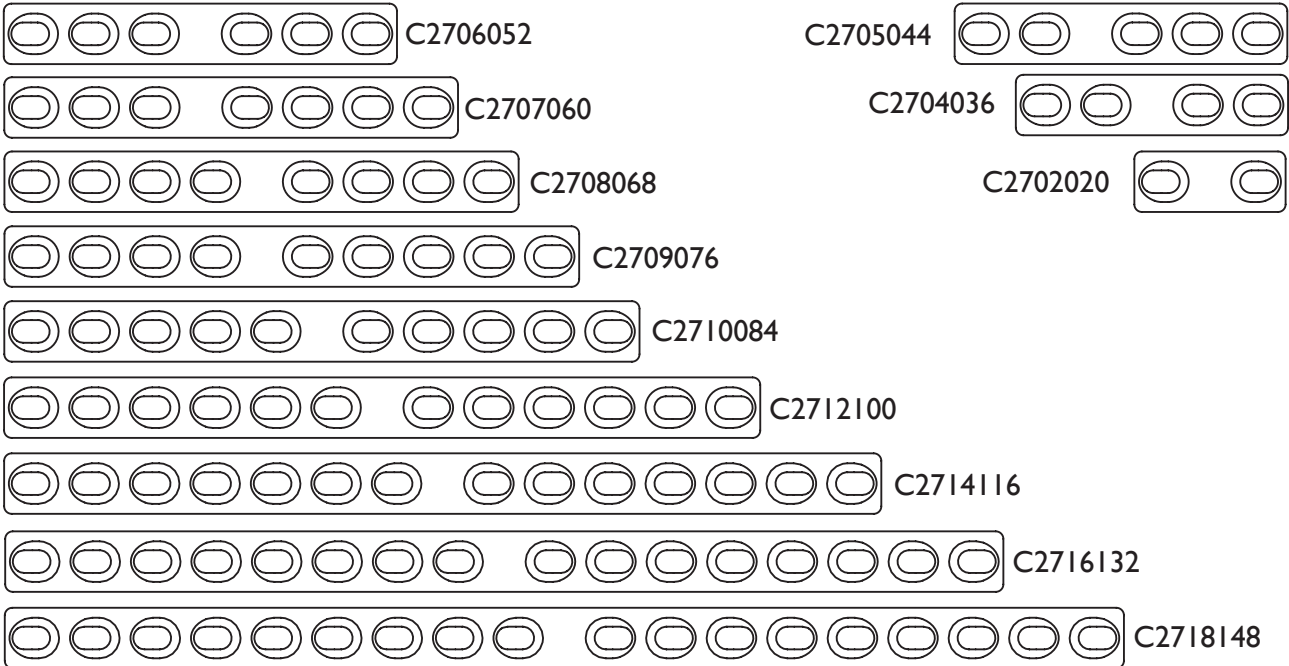

2.7mm ASYM® Plates

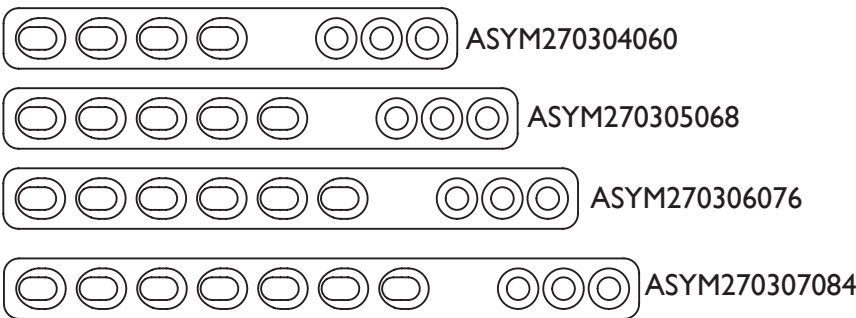

2.7mm Round Hole Plates

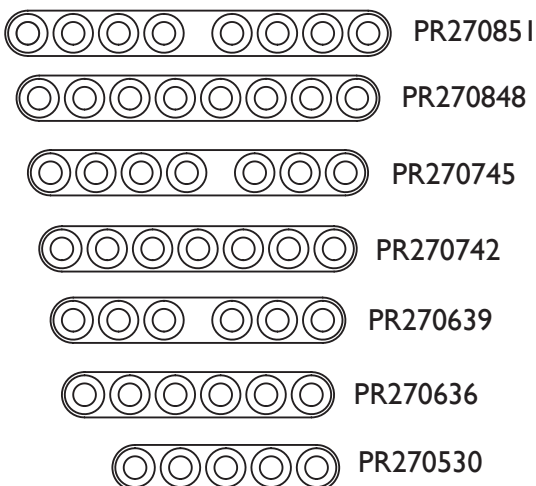

2.7mm Biological Healing Plates

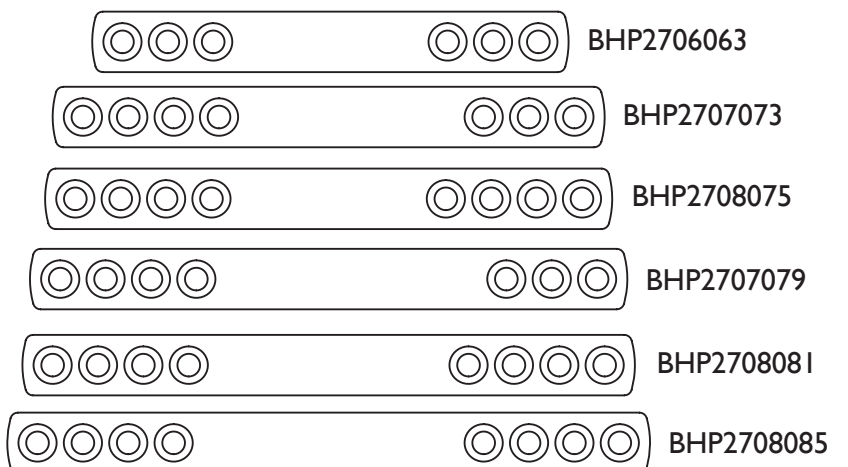

3.5mm Compression Plates

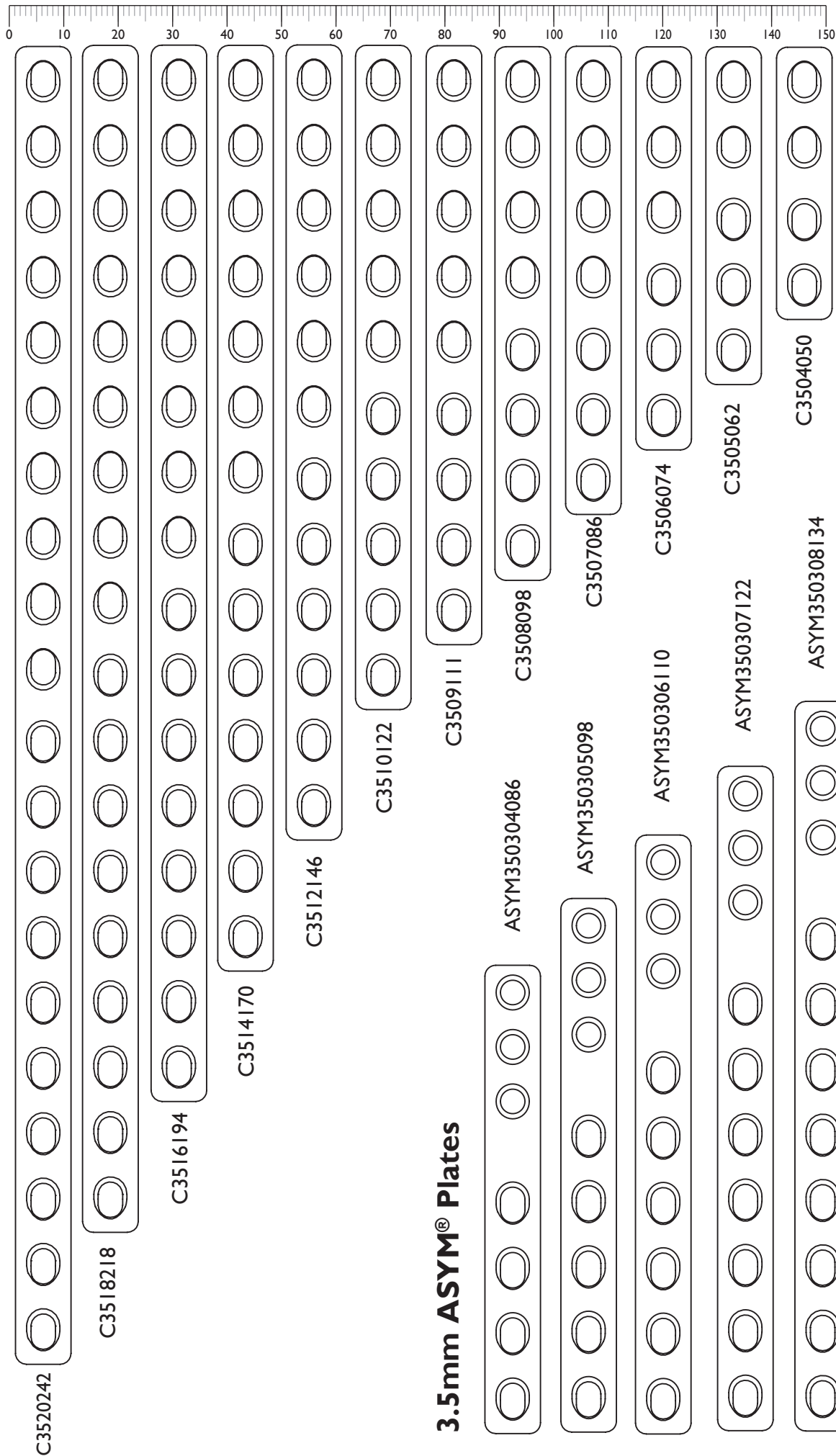

PLEASE NOTE THAT PLATE PROFILES ARE ACTUAL SIZE YOU WILL NEED TO COMPENSATE FOR X-RAY MAGNIFICATION • PROFILES FOR GUIDANCE ONLY PLATES MAY BE AMENDED AT ANY TIME

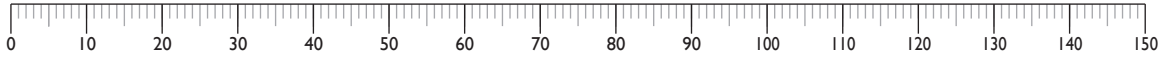

3.5mm Broad Compression Plates

BC3518218

BC3516194

BC3515182

BC3514170

BC3513158

BC3512146

BC3511134

BC3510122

BC3509110

BC3508098

BC3506074

BC3507087

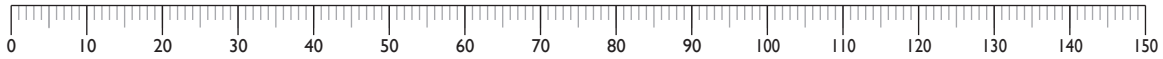

3.5mm Round Hole Plates

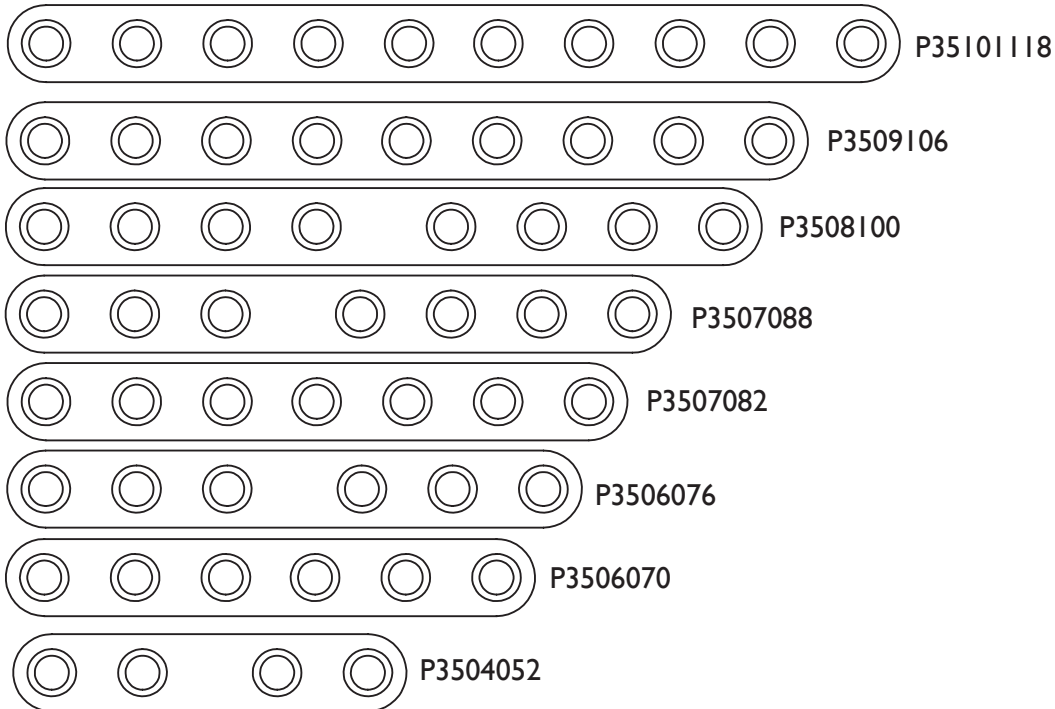

3.5mm Biological Healing Plates

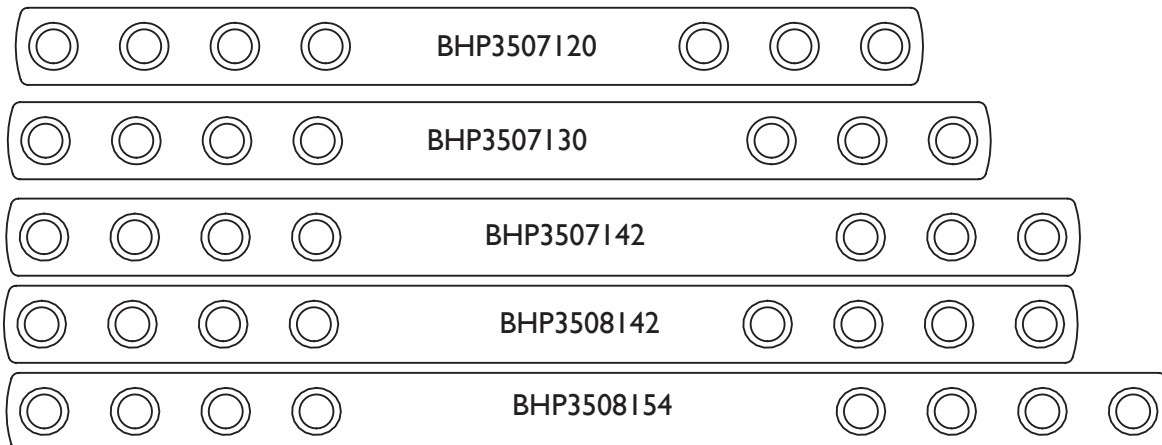

3.5mm Broad Biological Healing Plates

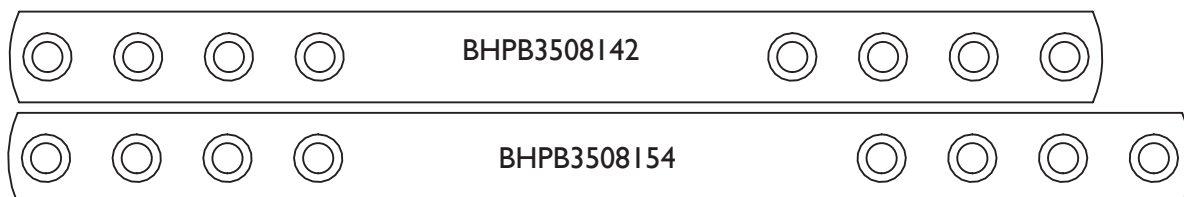

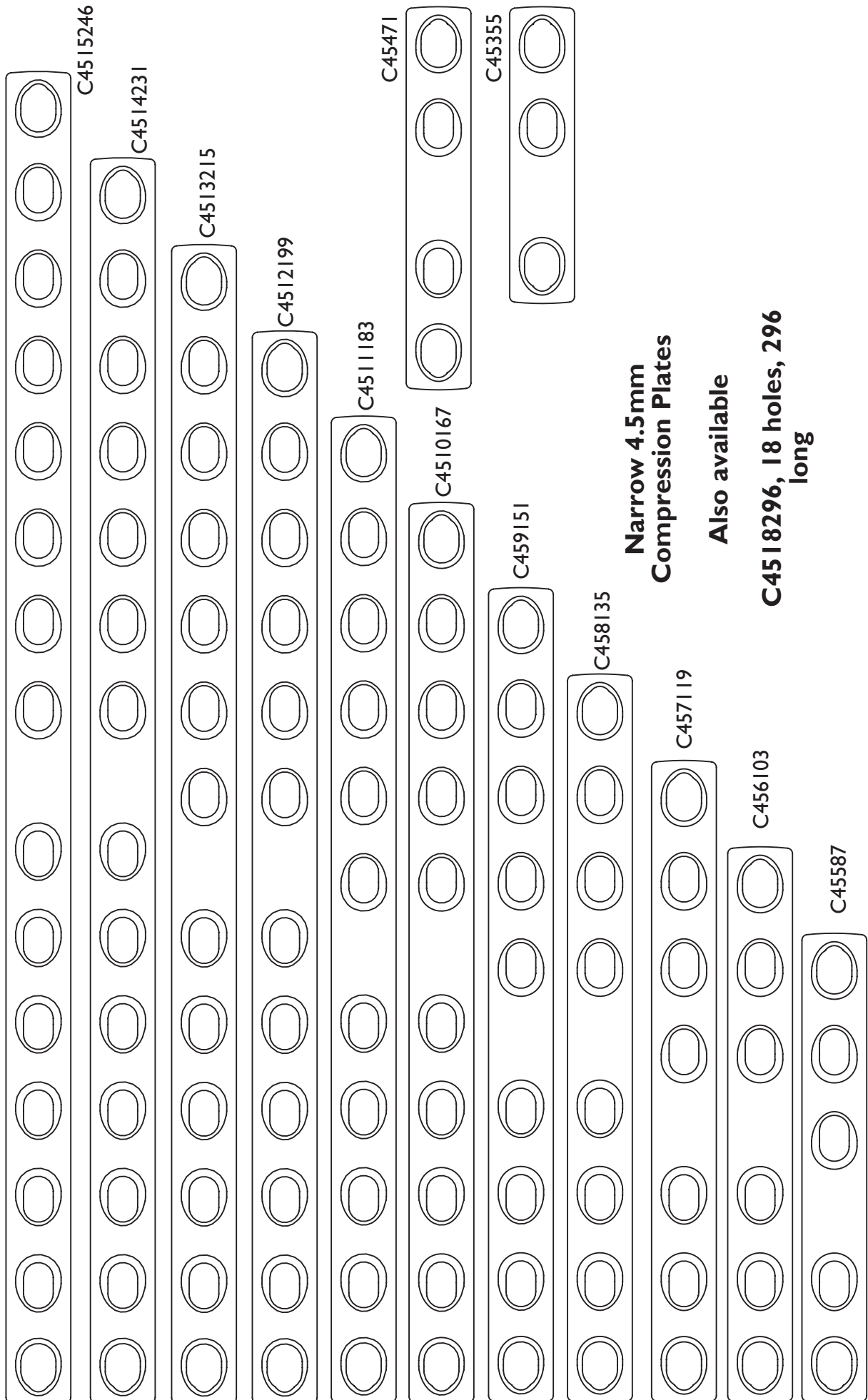

**Narrow 4.5mm
Compression Plates**
**Also available
C4518296, 18 holes, 296
long**

PLEASE NOTE THAT PLATE PROFILES ARE ACTUAL SIZE YOU WILL NEED TO COMPENSATE FOR X-RAY MAGNIFICATION • PROFILES FOR GUIDANCE ONLY PLATES MAY BE AMENDED AT ANY TIME

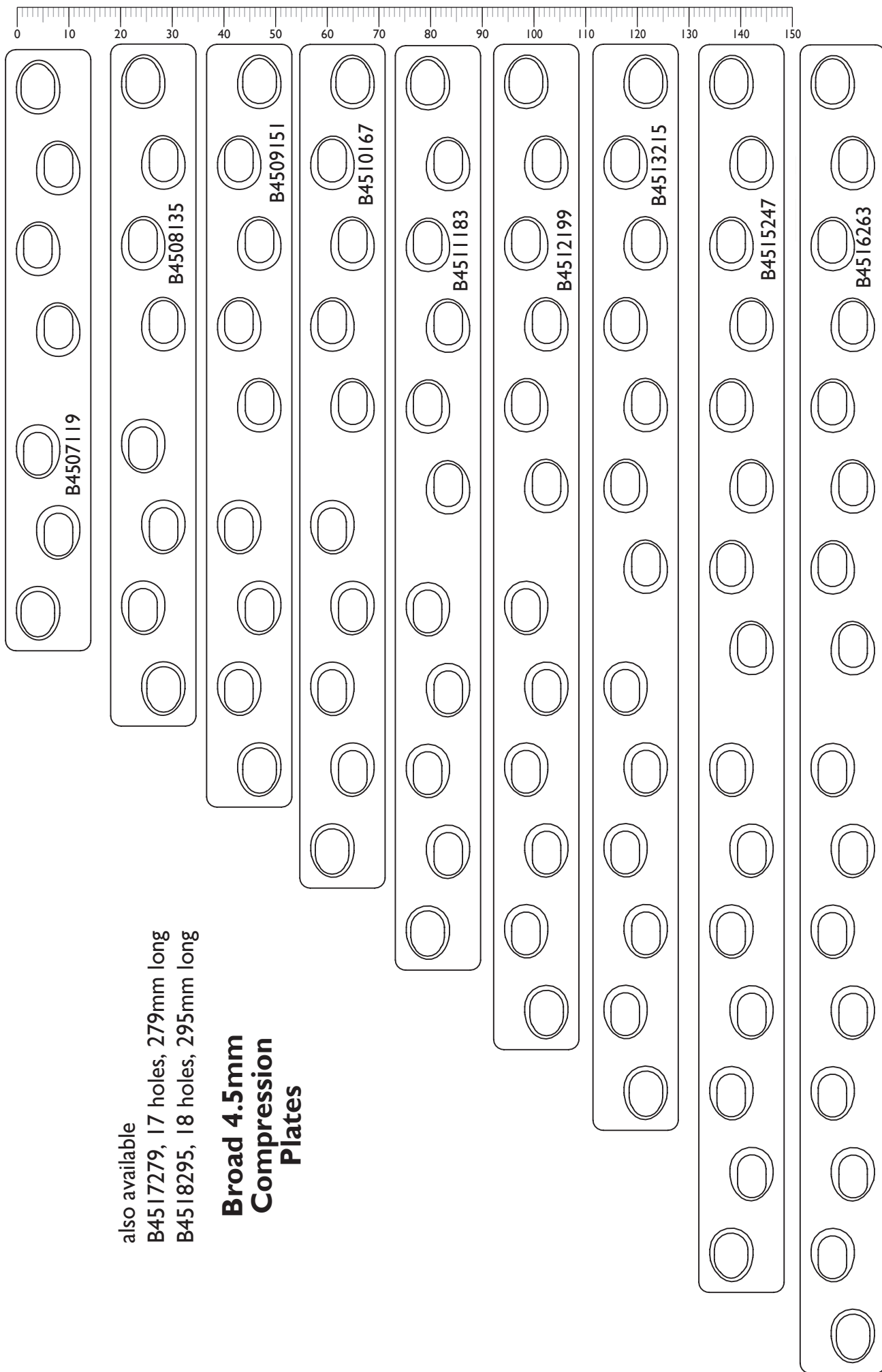

also available
B4517279, 17 holes, 279mm long
B4518295, 18 holes, 295mm long

**Broad 4.5mm
Compression
Plates**

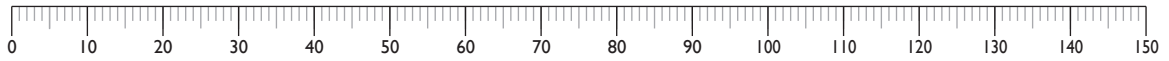

1.5mm T-Plates

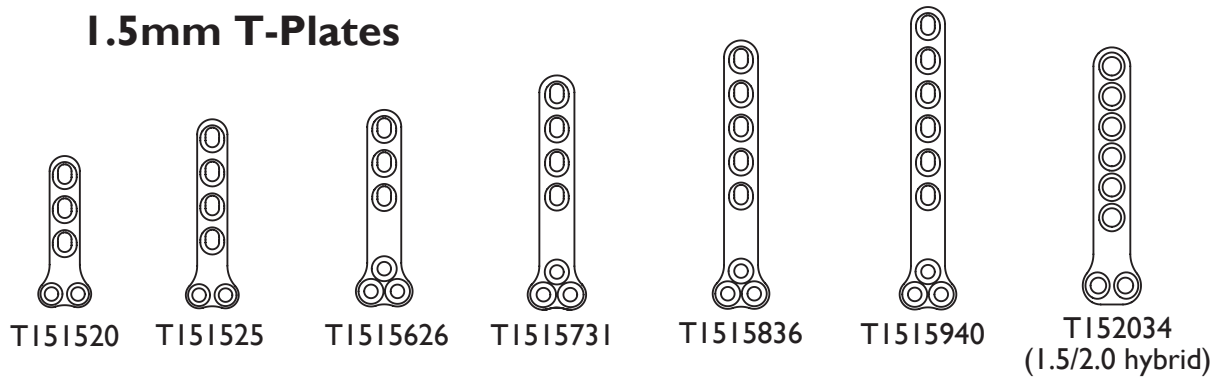

2.0mm T-Plates

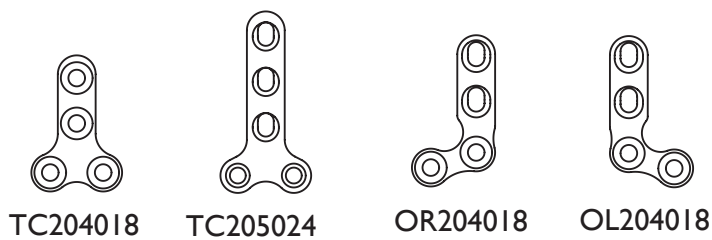
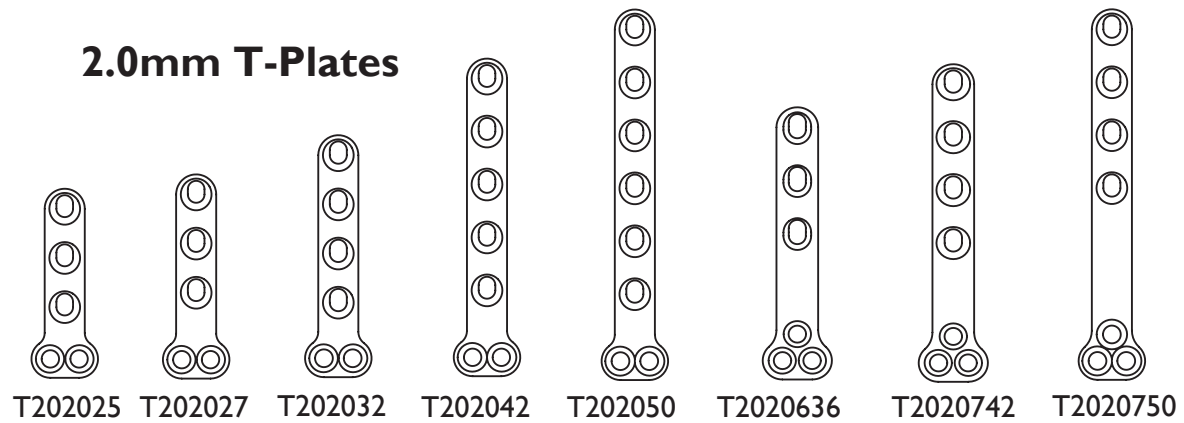

2.0/2.4/2.7mm Hybrid T-Plates

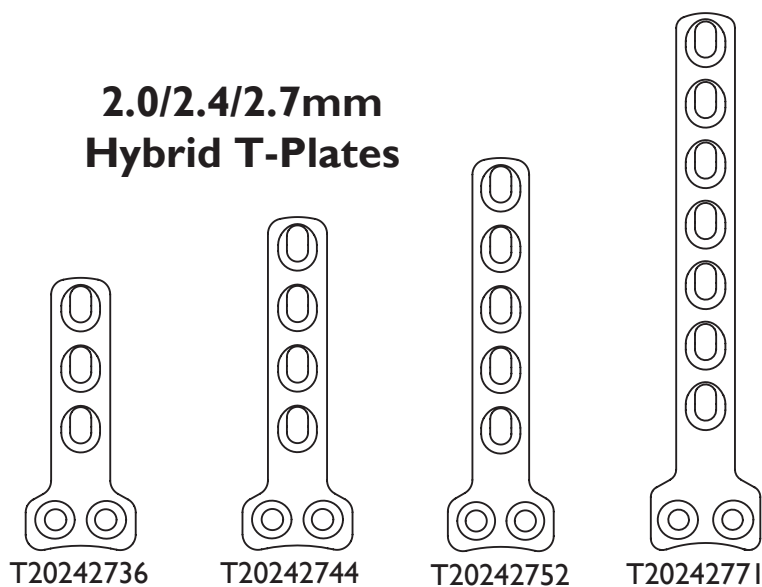

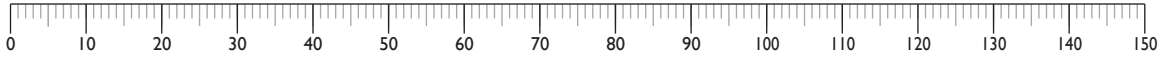

2.4mm and 2.7mm T-Plates

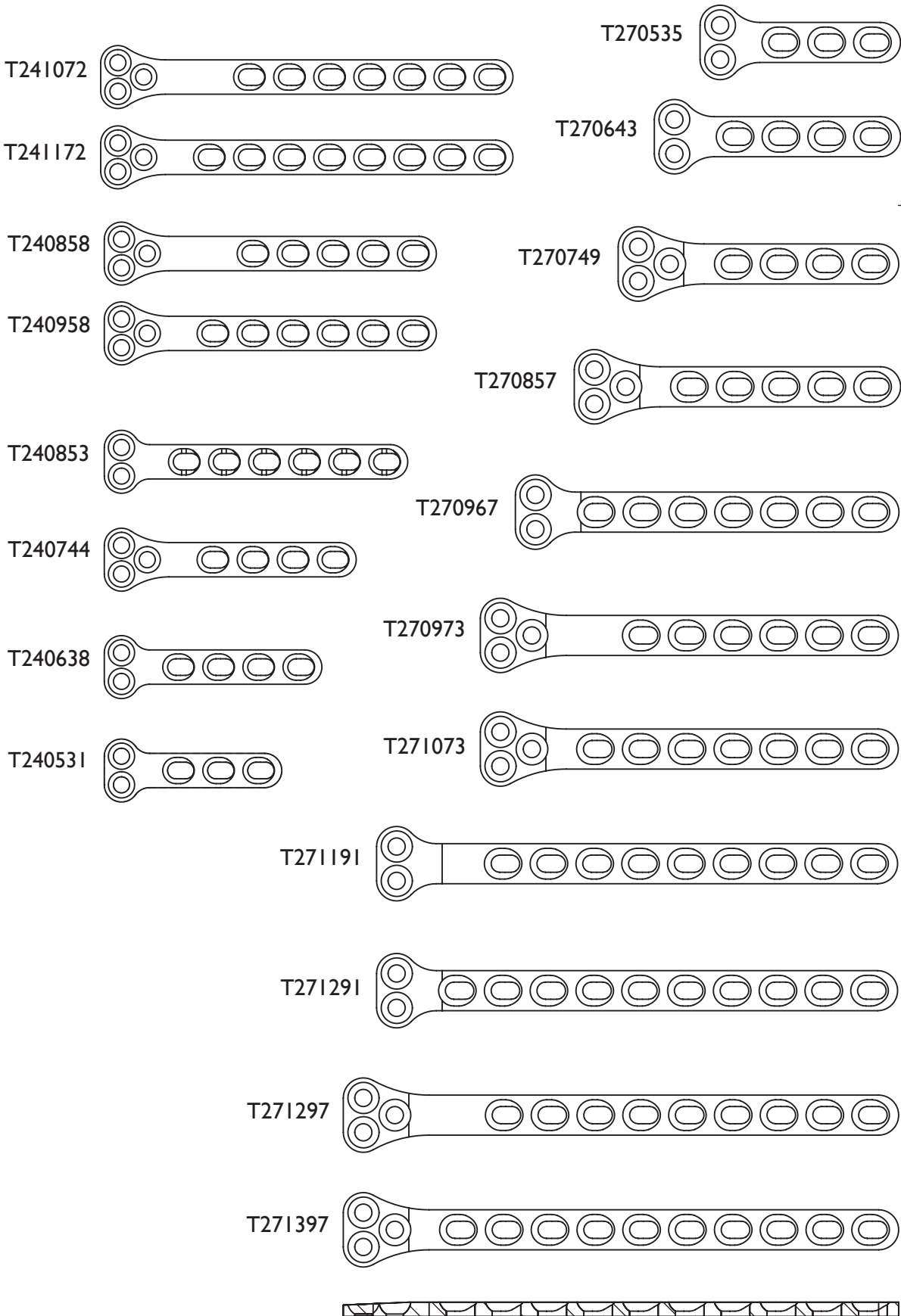

Tapered profile

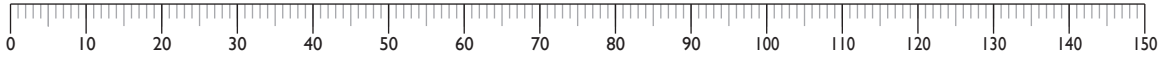

2.7mm T-Plates

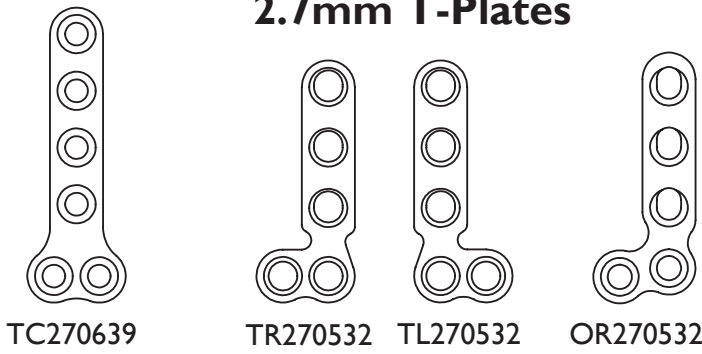

TC270639 TR270532 TL270532 OR270532

3.5mm T-Plates

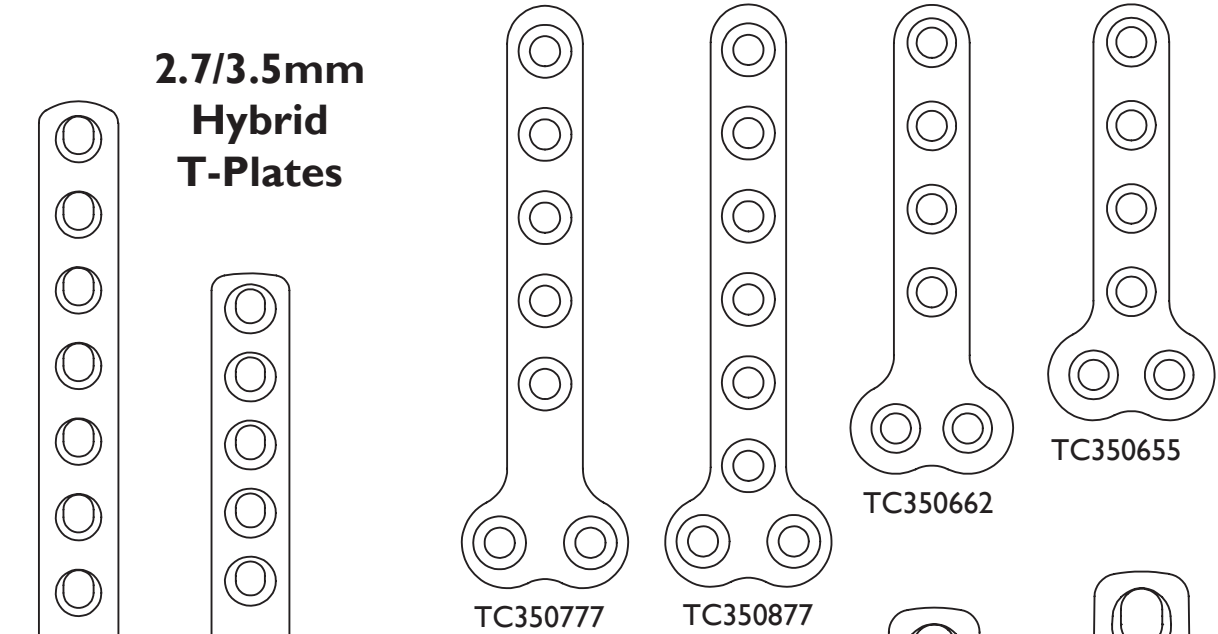

2.7/3.5mm Hybrid T-Plates

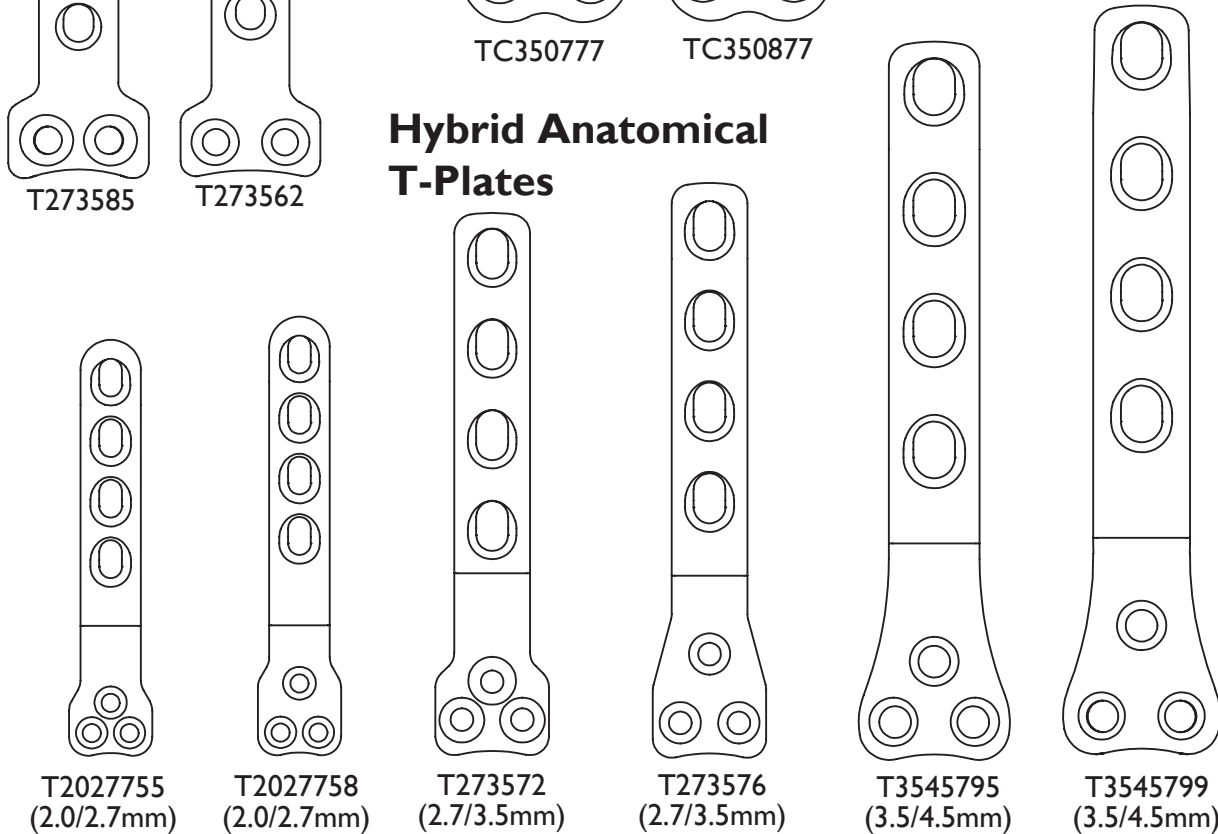

T2027755 (2.0/2.7mm) T2027758 (2.0/2.7mm) T273572 (2.7/3.5mm) T273576 (2.7/3.5mm) T3545795 (3.5/4.5mm) T3545799 (3.5/4.5mm)

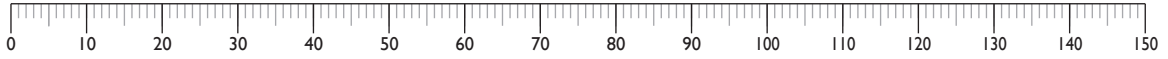

2.0mm Locking T-Plates

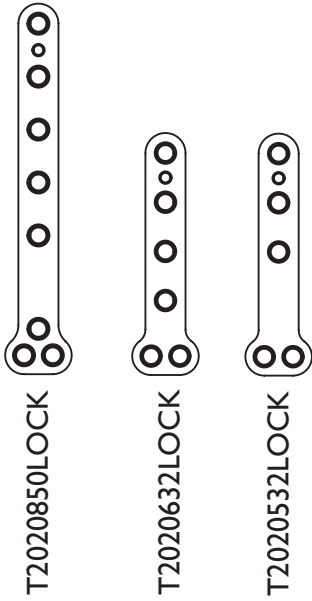

T2020850LOCK

T2020632LOCK

T2020532LOCK

2.4/2.7mm Locking T-Plates

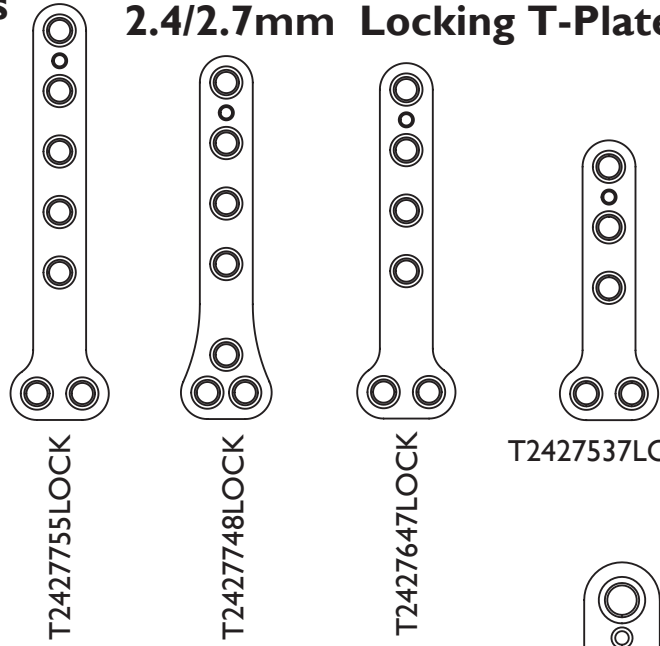

T2427755LOCK

T2427748LOCK

T2427647LOCK

T2427537LOCK

3.5mm Locking T-Plates

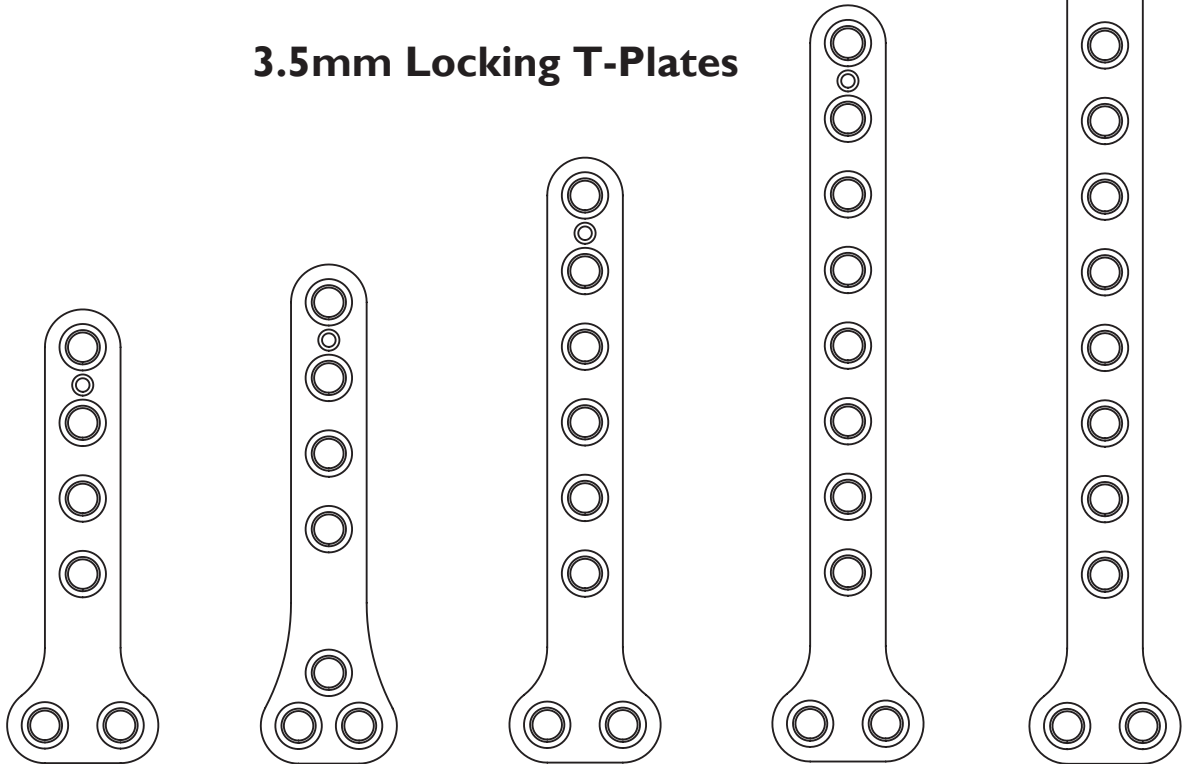

T350660LOCK

T350766LOCK

T350880LOCK

T3510100LOCK

T3512120LOCK

LokRod™ Plates

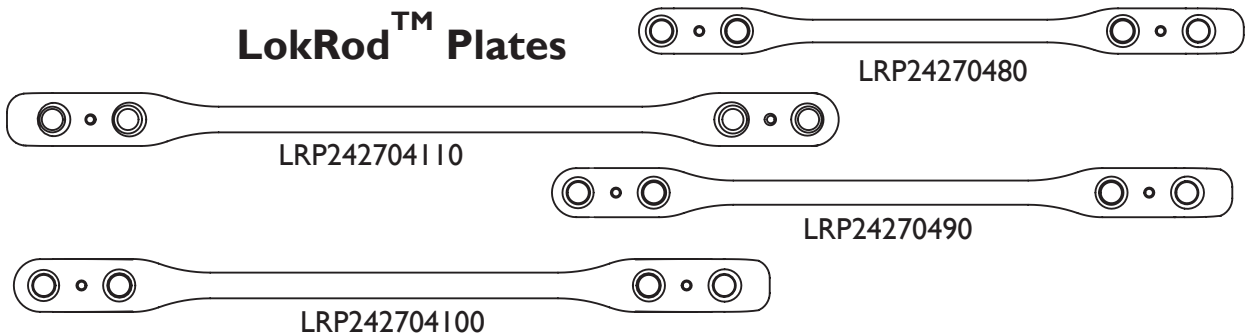

LRP24270480

LRP242704110

LRP24270490

LRP242704100

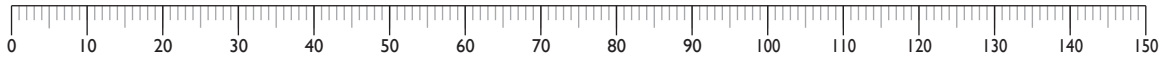

2.0mm Stacked Hole Locking Plates

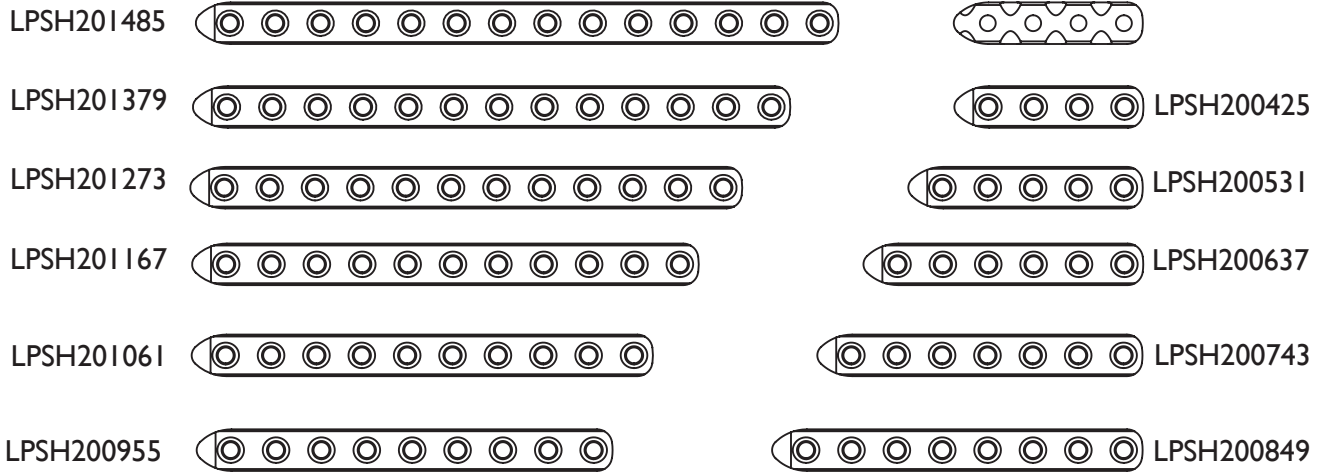

2.4mm Stacked Hole Locking Plates

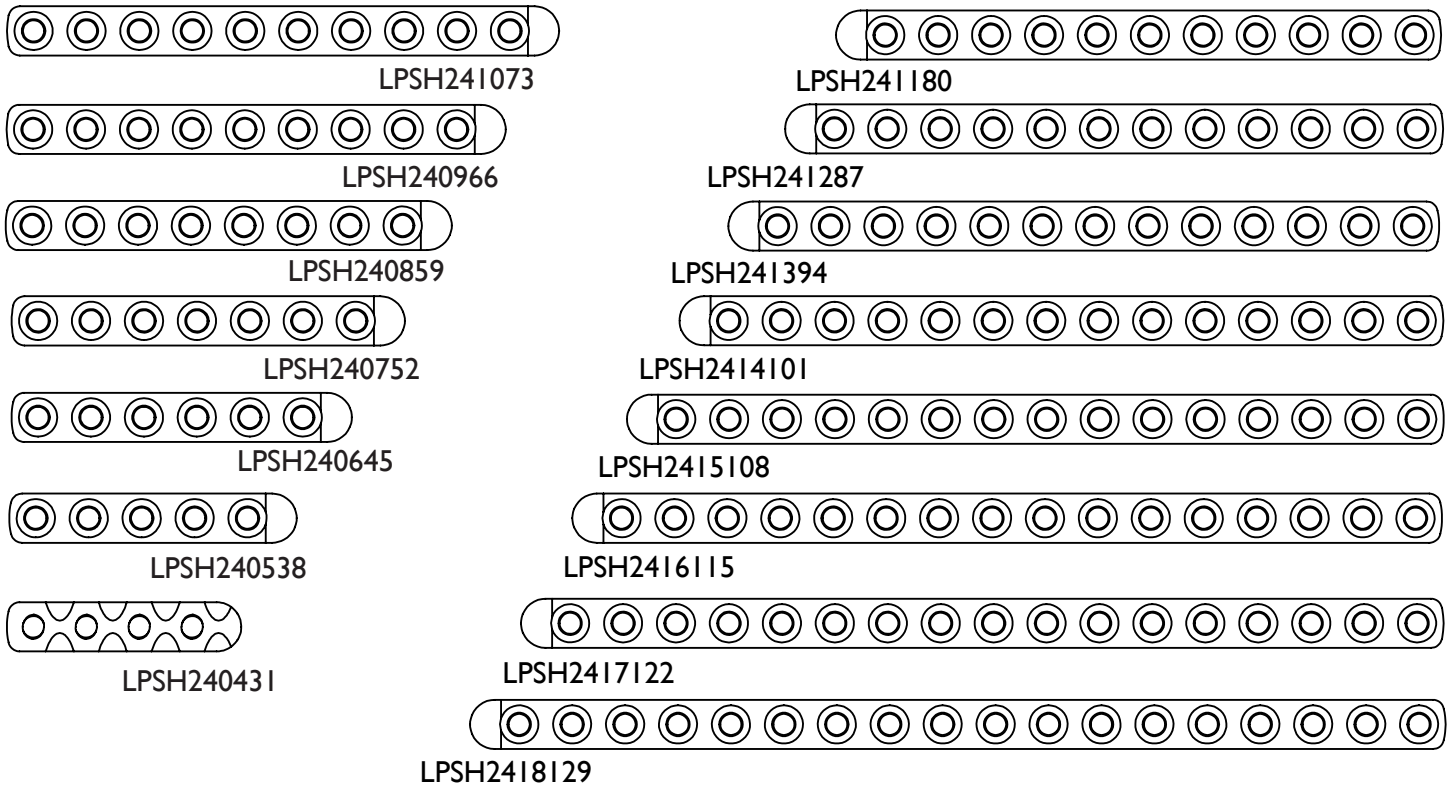

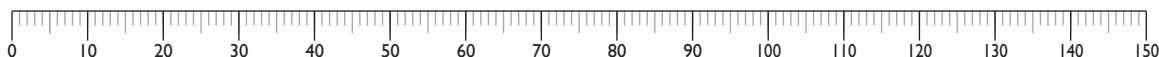

2.7mm Stacked Hole Locking Plates

Cuttable Malleable Locking Plates



15 holes, 205.5mm long

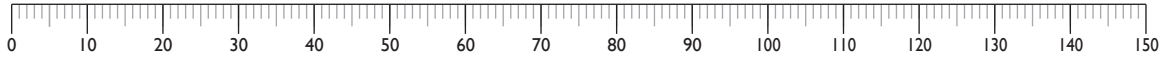

3.5mm Stacked Hole Locking Plates

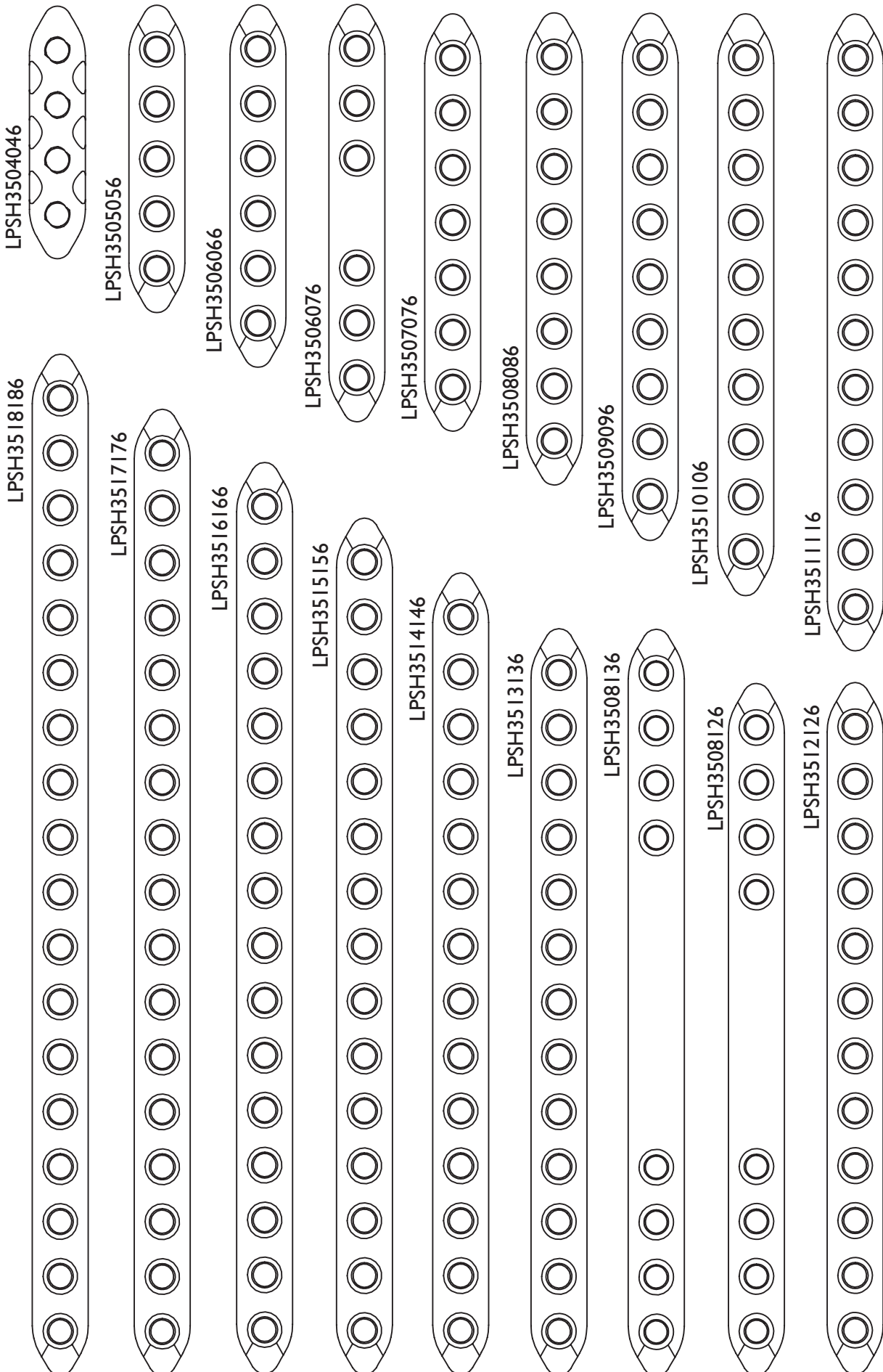

PLEASE NOTE THAT PLATE PROFILES ARE ACTUAL SIZE YOU WILL NEED TO COMPENSATE FOR X-RAY MAGNIFICATION • PROFILES FOR GUIDANCE ONLY PLATES MAY BE AMENDED AT ANY TIME

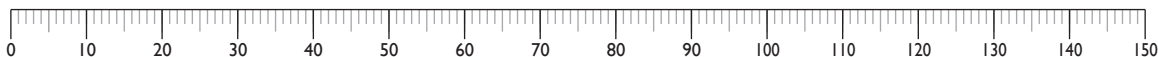

1.5mm Dynamic Locking Plates

2.0mm Dynamic Locking Plates



DLP1512072



DLP2014101



DLP1511066



DLP2013094



DLP1510060



DLP201287



DLP1509054



DLP2011080



DLP1508048



DLP2010073



DLP1507042



DLP2009066



DLP1506036



DLP2008059



DLP1505030



DLP2007052



DLP1504024



DLP2006045



DLP2005038



DL2004031

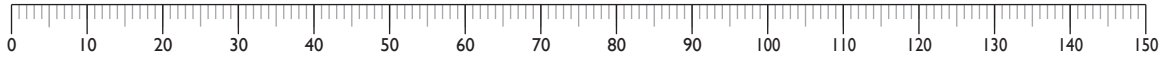

DLP2418164K



DLP2417155K



DLP2416146K



DLP2415137K



DLP2414128K



DLP2413119K or ...N

2.4mm Dynamic Locking Plates



DLP2412110K

DLP24xxxxxK = 2mm thick
DLP24xxxxxN = 1.7mm thick



DLP2411101K or ...N



DLP2404038N



DLP2410092K or ...N



DLP2405047K or ...N

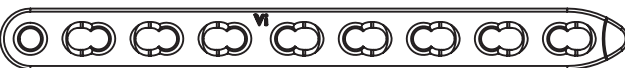

DLP2409083K or ...N



DLP2406056K or ...N



DLP2408074K or ...N



DLP2407065K or ...N



DLP2718164



DLP2717155



DLP2716146



DLP2715137



DLP2714128



DLP2713119



DLP2712110



DLP2711101



DLP2704038



DLP2710092



DLP2705047



DLP2709083



DLP2706056



DLP2708074



DLP2707065



**2.7mm
Dynamic
Locking
Plates**

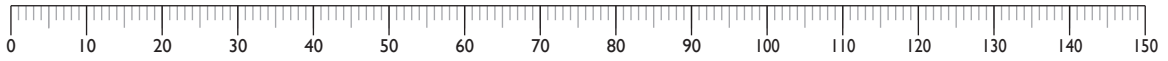

3.5mm Dynamic Locking Plates

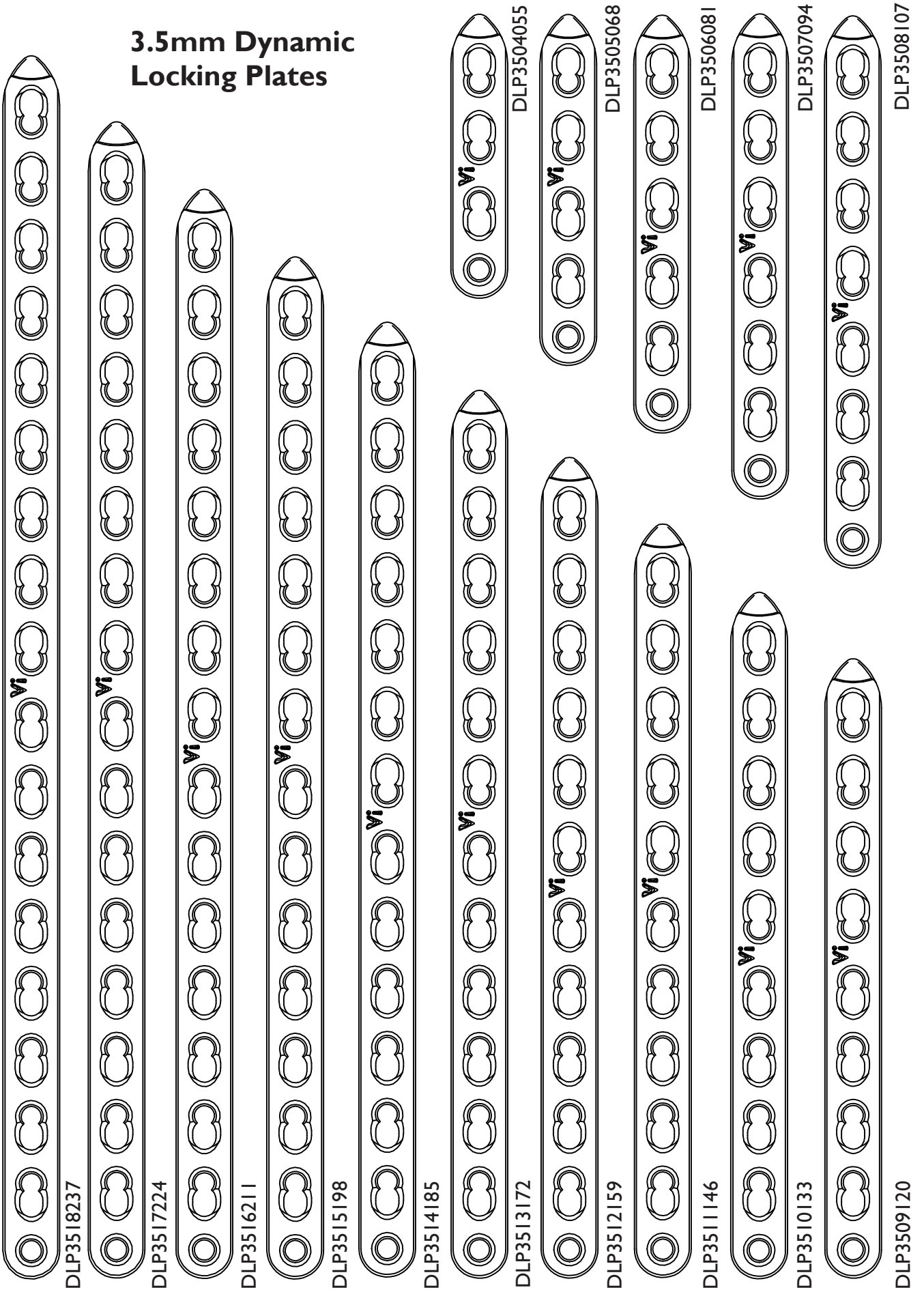



Butterfly Plates

1.5mm

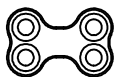

BTFP15414

2.0mm

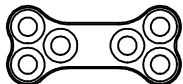

BTFP20623

TPO Plates

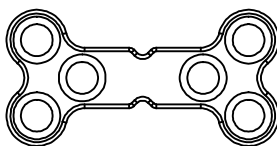

090179

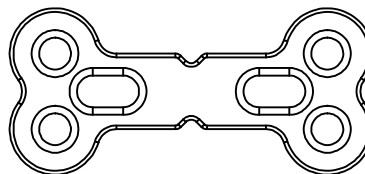

090167

Acetabular Plates



AP200400xs (2.0)

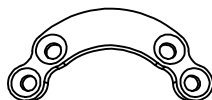

AP2004001L (2.0)

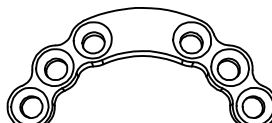

AP270603 (2.7)



AP350605 (3.5)



AP200400 (2.0)



AP240406 (2.4)

Contoured in 3 Dimensions

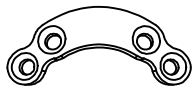

AP200401 (2.0)



AP270602 (2.7)



AP350604 (3.5)

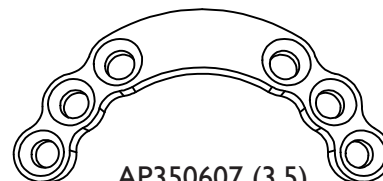

AP350607 (3.5)

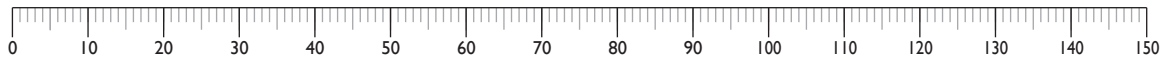

Cuttable Plate Range

1.5mm	CPI5413030		
	CPI5413030B		
	CPI5413027		
	CPI5413027B		
2.0mm	CP205150		
	CP205150B		
	CP20515027		
	CP20515027B		
2.4mm	CP2455150		
	CP245515024		
2.7mm	CP276150		
	CP276150B		
	CP27615022		
	CP27615022B		
3.5mm	CP3575150		
	CP357515018		
1.5mm	CMI5413030		
2.0mm	CM205150		
2.4mm	CM2455150		
2.7mm	CM276150		
3.5mm	CM3575150		
2.0mm	DCCP206150		
2.4mm	DCCP247150		
2.7mm	DCCP278150		

VCP202427 (2.0/2.4/2.7, 1.2mm thick, 300mm long, 50 holes) / VCP202427B, 2.0mm thick, 300mm long, 50 holes

PLEASE NOTE THAT PLATE PROFILES ARE ACTUAL SIZE YOU WILL NEED TO COMPENSATE FOR X-RAY MAGNIFICATION • PROFILES FOR GUIDANCE ONLY PLATES MAY BE AMENDED AT ANY TIME



I.0mm Series

C100210	CMI0390
C100418	
C100522	CP10390
C100626	
C100730	CP1039027
C100834	
C100938	CP10491
C101042	CP1049120
T101016	T101018
T101020	T101022
T101024	T101026
	T101021
	T101027

Partial Tarsal Arthrodesis

152925 (2.7/3.5)		
152921 (2.7/3.5)		
152922 (2.7/2.7)		
152920 (2.0/2.7)		
152920SC (2.0/2.7)		
152923 (2.0/2.0)		
152924 (1.5/2.0)		

Elbow Arthrodesis
 152950 (2.7/3.5) RIGHT
 152951 (2.7/3.5) LEFT

Locking version also available.
 152950LOCK (2.7/3.5) RIGHT
 152951LOCK (2.7/3.5) LEFT

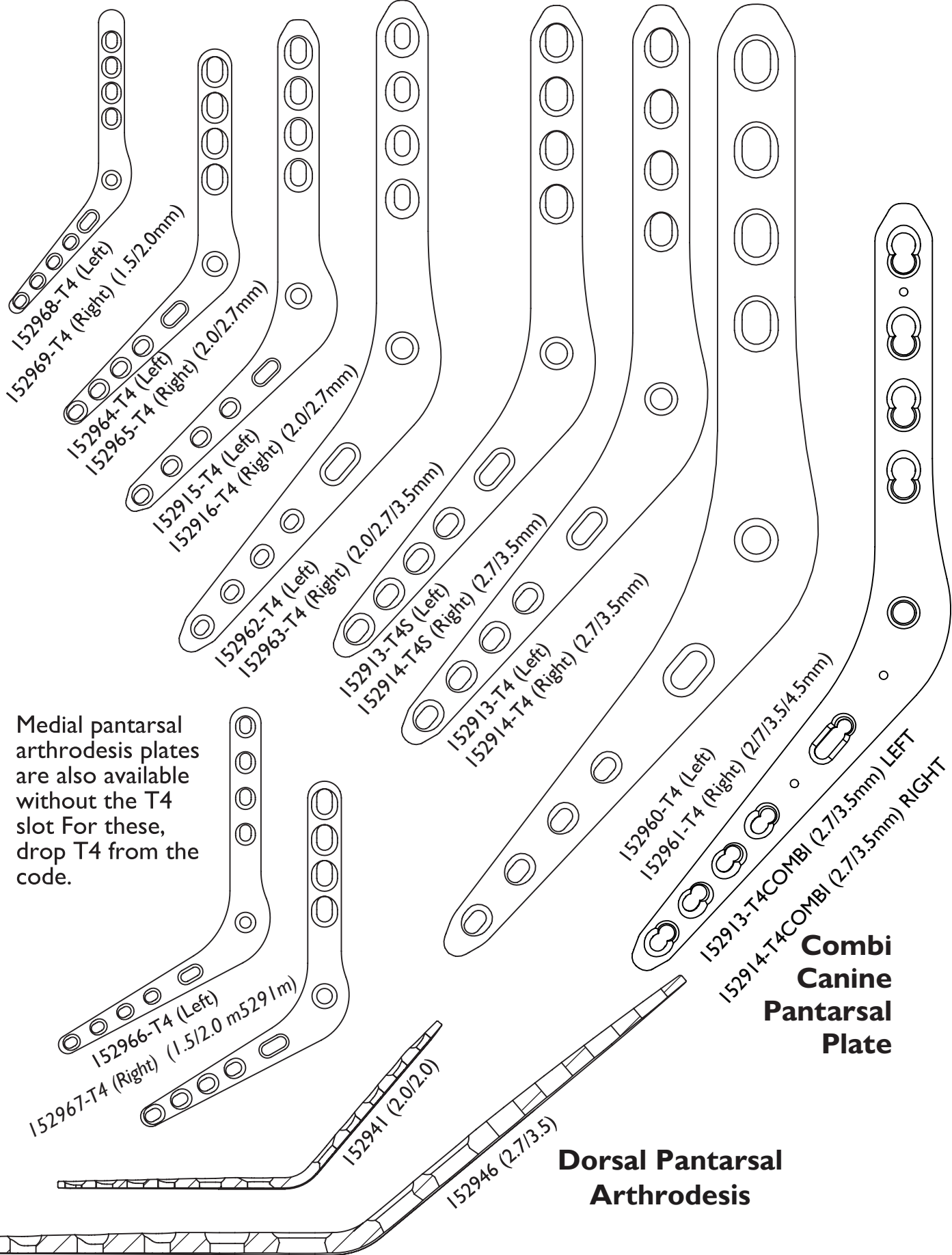
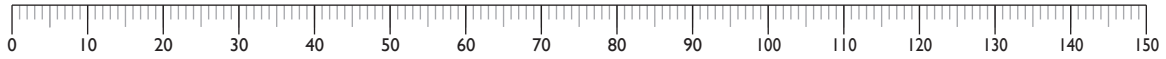

Medial pantarsal arthrodesis plates are also available without the T4 slot For these, drop T4 from the code.

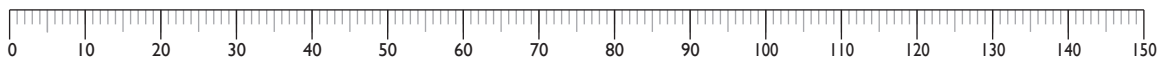

Combi T-Plates



T1515836LOCK



T20201065COMBI



T151532COMBI



T20201279COMBI



T1515735COMBI

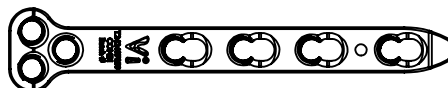

T242407059COMBI



T1515947COMBI



T242408068COMBI



T15151159COMBI

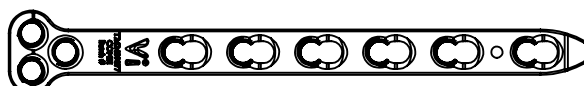

T242409077COMBI



T202033COMBI

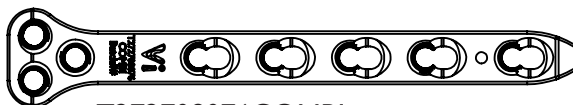

T272708076COMBI



T202040COMBI

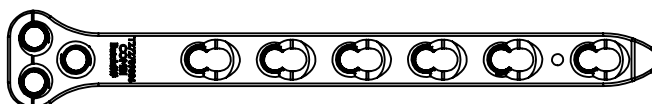

T272709086COMBI

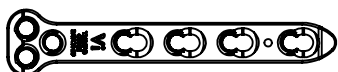

T2020743COMBI

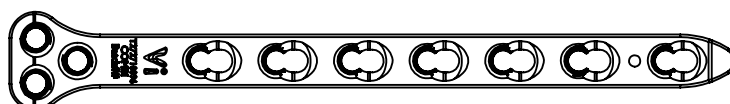

T272710096COMBI



T2020850COMBI

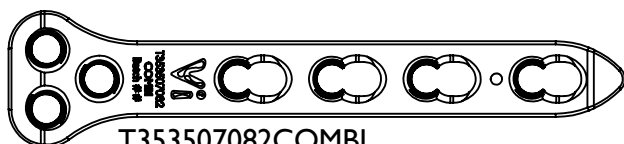

T353507082COMBI

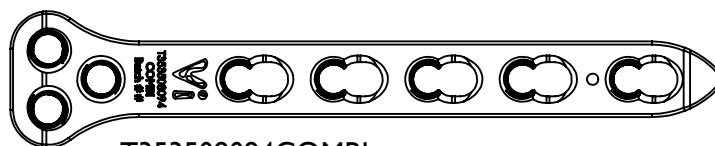

T353508094COMBI

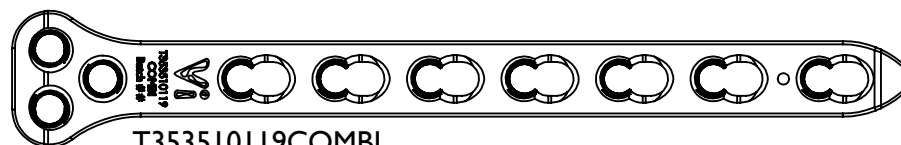

T353510119COMBI

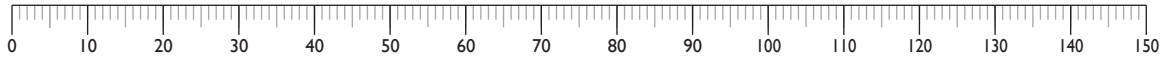

Locking Pancarpal Arthrodesis Plates

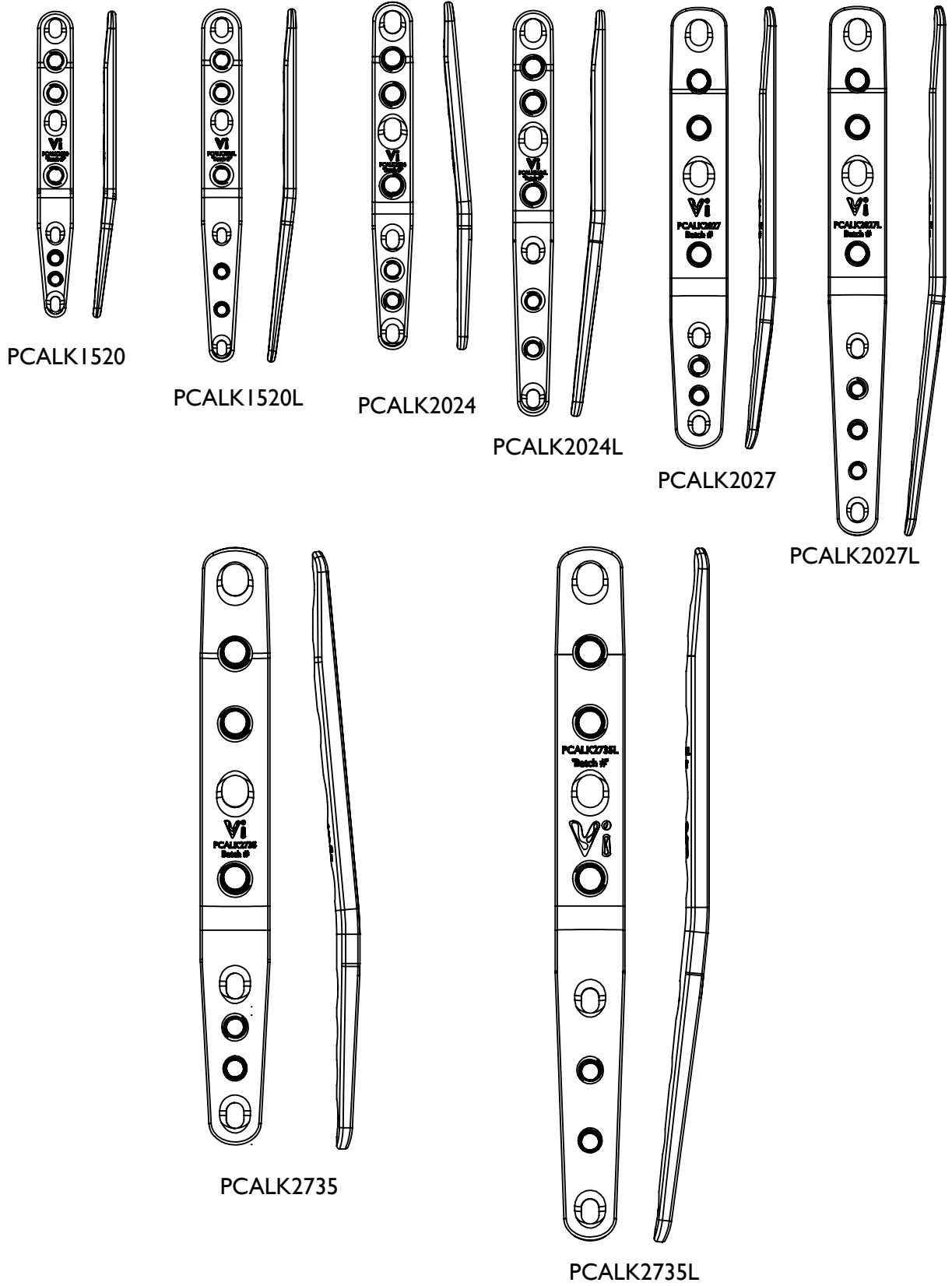

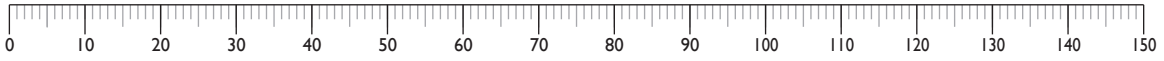

152909 (DCP)
(3.5/4.5)

152907XL (DCP)
(3.5/3.5)

152907 (DCP)
152908 (ROUND)
(3.5/3.5)

152903 (DCP)
152904XL (ROUND)
(2.7/3.5)

152903XL (DCP)
152904 (ROUND)
(2.7/3.5)

152902 (DCP)
(2.0/2.7)

152905 (DCP)
ROUND 152906
(2.0/2.7)

152905XL (DCP)
(2.0/2.7)

152912XL (DCP)
(2.0/2.0)

15291XL (DCP)
(1.5/2.0)

152912 (DCP)
(2.0/2.0)

152911 (DCP)
(1.5/2.0)

152970 (DCP)
(1.0/1.5)

Locking versions of select pancarpal arthrodesis plates are available.

Pancarpal Arthrodesis Plates

Partial Carpal Arthrodesis Plates

152930
(2.7/3.5)

152931
(2.0/2.4/2.7)

152932
(1.5/2.0)

Feline Forelimb Salvage Plate

152910
(1.5/2.0)

PLEASE NOTE THAT PLATE PROFILES ARE ACTUAL SIZE YOU WILL NEED TO COMPENSATE FOR X-RAY MAGNIFICATION • PROFILES FOR GUIDANCE ONLY PLATES MAY BE AMENDED AT ANY TIME



I52980 (3.5 locking/2.7/3.5/4.5) NOTE: Scale 1:2



I52903XXL (2.7/3.5) NOTE: Scale 1:2

Longer Plates

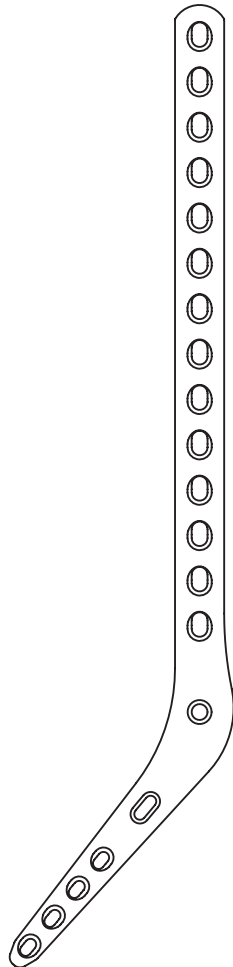

I52913-T4XL (Left)
I52914-T4XL
(Right) 2.7/3.5mm
NOTE: Scale 1:2

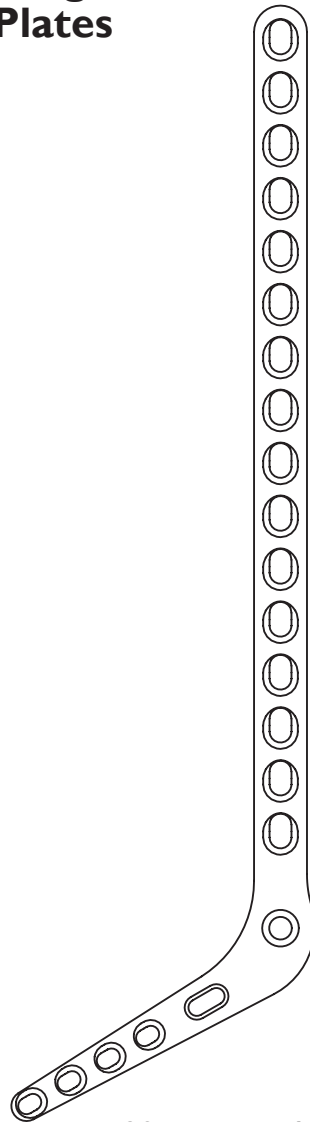

I52917-T4XL (Left)
I52918-T4XL
(Right) 2.0/2.7mm
NOTE: Scale 1:1

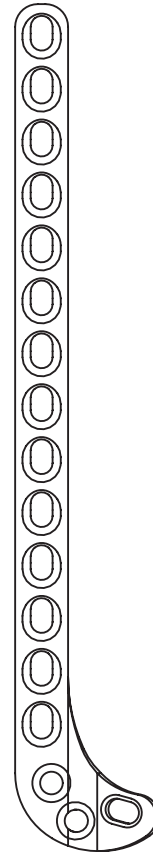

I52711L-XL (Left)
I52711R-XL
(Right) 2.4mm
NOTE: Scale 1:1

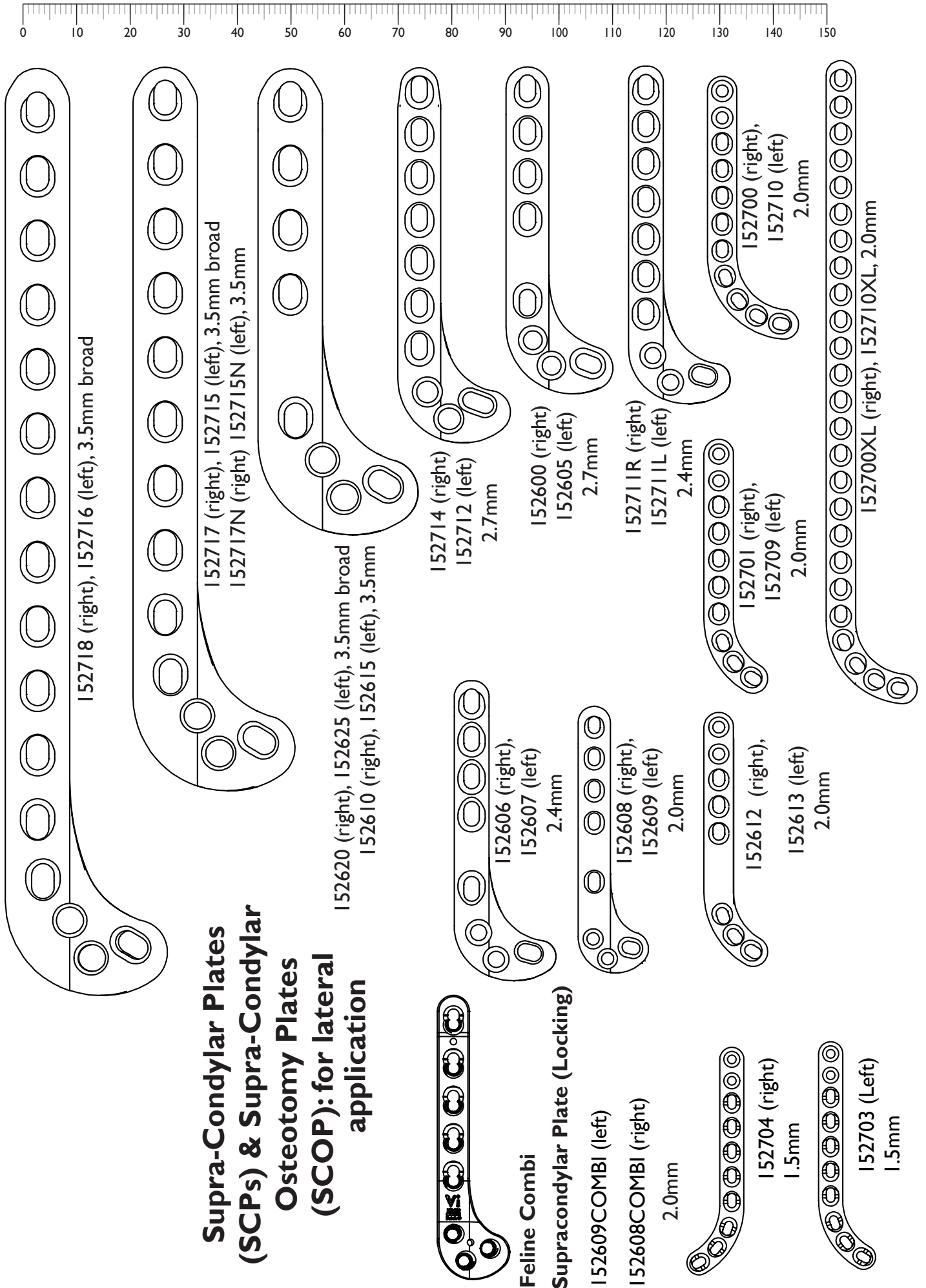

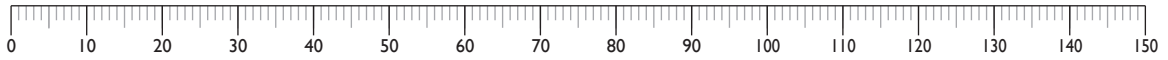

Cloverleaf TTO/TPLO Plates

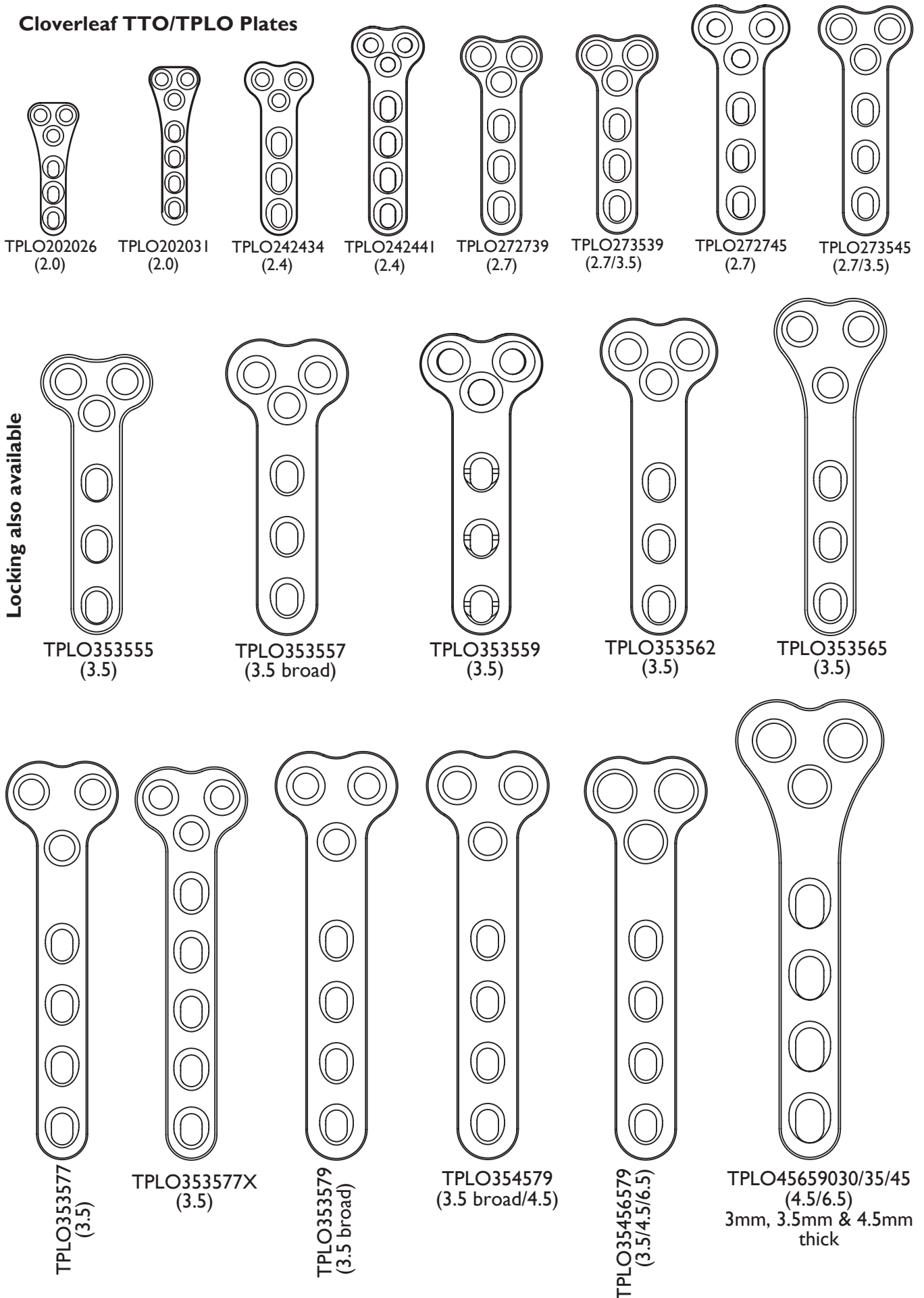

PLEASE NOTE THAT PLATE PROFILES ARE ACTUAL SIZE YOU WILL NEED TO COMPENSATE FOR X-RAY MAGNIFICATION • PROFILES FOR GUIDANCE ONLY PLATES MAY BE AMENDED AT ANY TIME



Slocum Style TPLO Plates

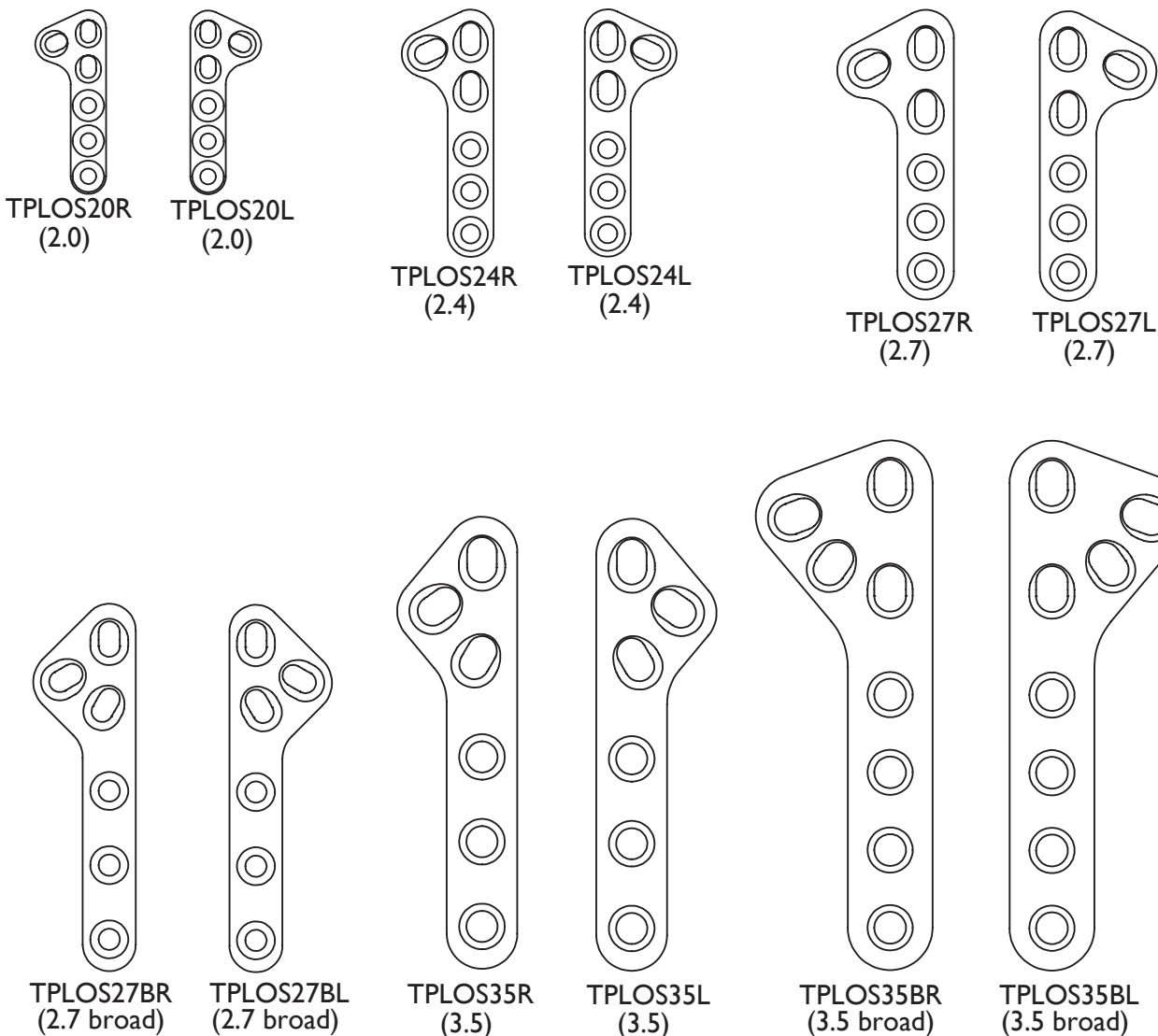

Locking TPLO Plates

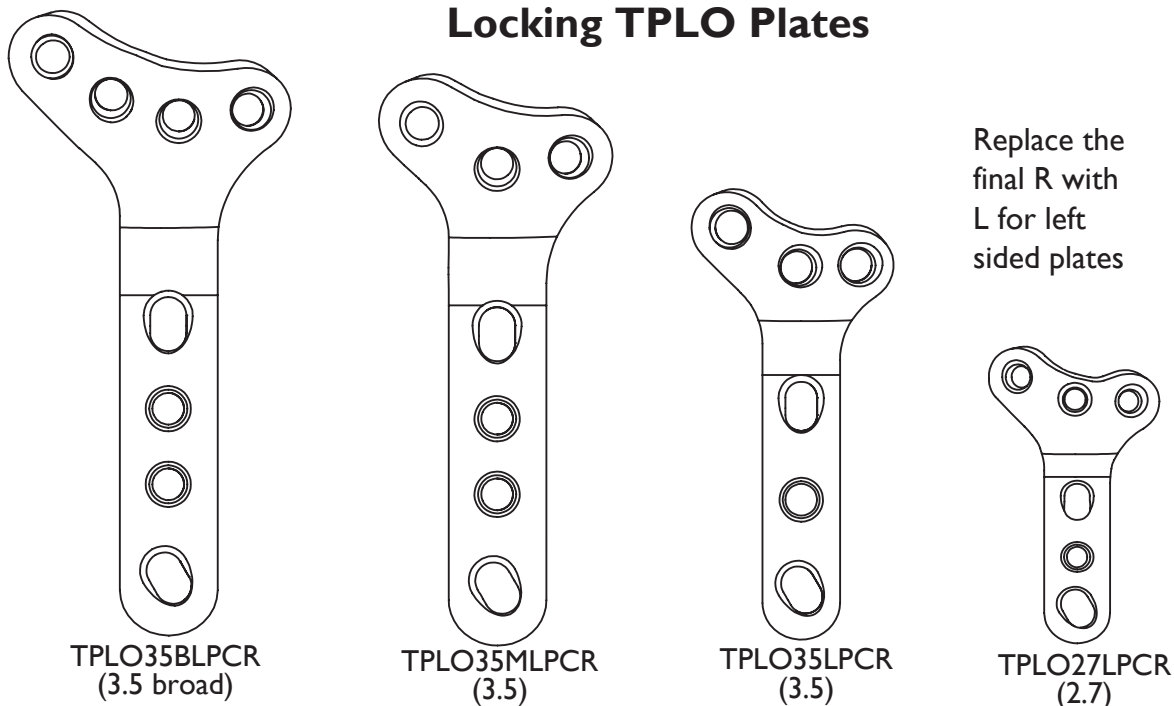

PLEASE NOTE THAT PLATE PROFILES ARE ACTUAL SIZE YOU WILL NEED TO COMPENSATE FOR X-RAY MAGNIFICATION • PROFILES FOR GUIDANCE ONLY PLATES MAY BE AMENDED AT ANY TIME

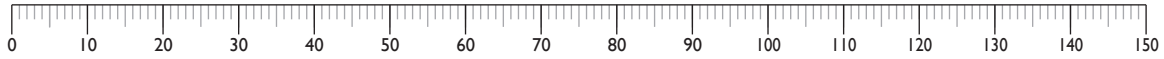

Vi Locking TPLO Plates

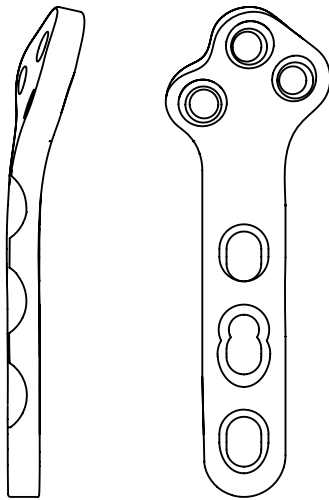

ViLTPLO35L3
plate profile

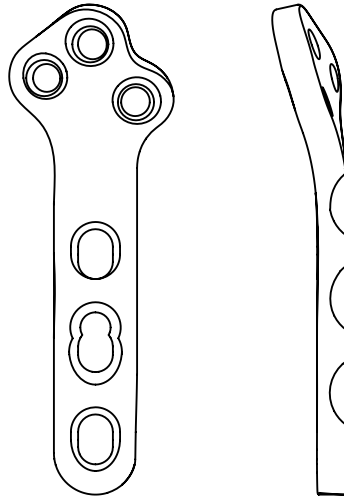

ViLTPLO35R3
plate profile

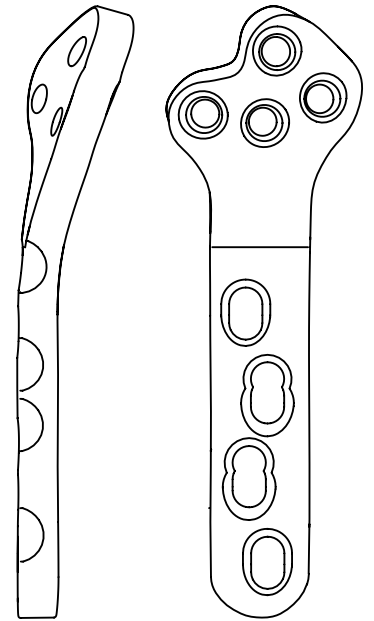

ViLTPLO35BL4
plate profile

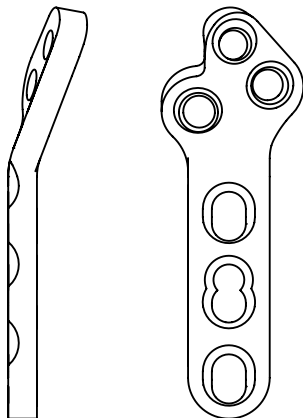

ViLTPLO35SL3
plate profile

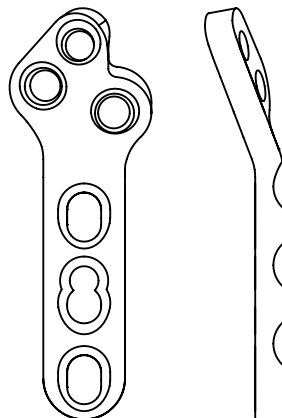

ViLTPLO35SR3
plate profile

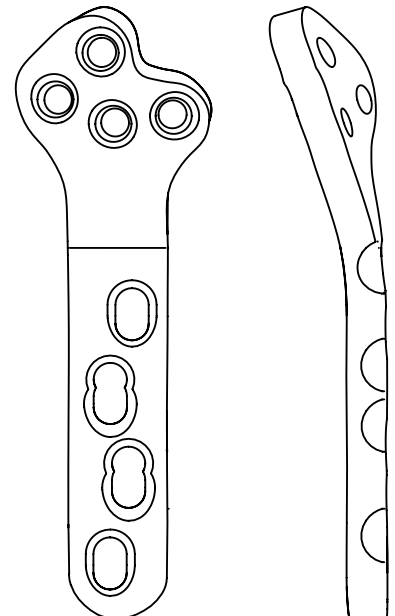

ViLTPLO35BR4
plate profile

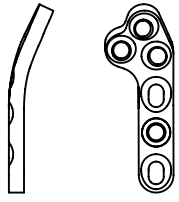
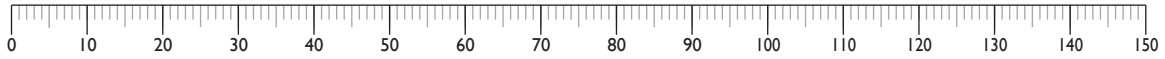

VILTPLO15L3
plate profile

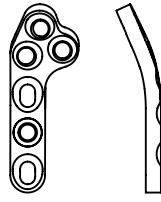

VILTPLO15R3
plate profile

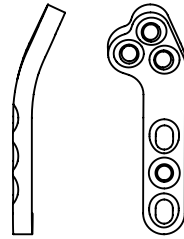

ViLTPLO20L
plate profile

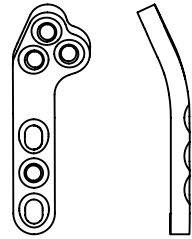

ViLTPLO20R
plate profile

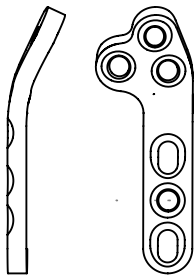

ViLTPLO24L
plate profile

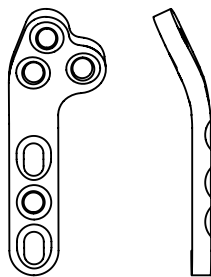

ViLTPLO24R
plate profile

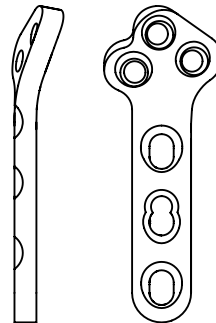

ViLTPLO27L3
plate profile

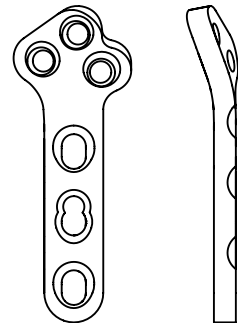

ViLTPLO27R3
plate profile

Index

Index

1.0mm Compression Plates	87
1.0mm Cortical Self Tapping Screws	87
1.0mm Cuttable Plates	87
1.0mm Drill Guide	87, 132
1.0mm Plates and Screws	87
1.0mm Plating Kit	85
1.0mm Plating System - Drill Bits	87
1.0mm Plating System - Drill Guide	87
1.0mm Plating System - Plate Holding Forceps	87
1.0mm T-Plates	87
1/2 Teeth Dissecting Forceps	182
1.5mm Screws	114
2.0mm Screws	114-115
2.4mm Screws	115
2.7mm Screws	116
3.5mm Screws	116-117
3CON Stems	75
4.5mm Screws	118
5.5mm Screws	119
40° Bone Punch Forceps (Low Profile)	164

A

AAS Darvall Warm Air System	234
Abdominal Retractors	184
Abdominal Surgery	196-199
Acculan 4 Power Tools	149
Acetabular Plates	100
Adjustable Bone Saw	16, 65
Adjustable Drill Guide	59, 68, 107, 132
Adson Dissecting Forceps	183
Adson Suction Tip	232
AESFULAP Acculan 4 Power Tools	149
Air Hoses	157-158
Air Instrument Care Products	158
Air Regulators	158
Airway Surgery	191-192
A/K Wire Bender	16
A/K Wire Dispenser	129
A/K Wire Holders	129
A/K Wire/Pin Punches	16
A/K Wire Remover	24
Alligator Grasping Forceps - Arthroscopic	73
Allis Tissue Forceps	175, 192
Allis Tissue Forceps - Angled	192
Ameroid Constrictors	198
Anaesthetic Circuits - Heated	235
Anaesthetic Monitoring	235-236
Anal Sac Excision Kit	203
Ancillary Helica Instrumentation	74
Angiotribe	196
Angled Allis Tissue Forceps	192
AO-Fit Handles	122-124
AO-Fit Quick Release Drill Bits	125-126
AO Type Periosteal Elevator	15
Apical Elevator	215
Arruga Capsule Forceps	210
Artery Forceps	174
Artery Forceps - Left Handed	188
Arthrodesis and Kirschner Wire Remover	24

Arthrodesis Plates - Carpal	101
Arthrodesis Plates - Elbow	104
Arthrodesis Plates - Tarsal	102-103
Arthrodesis Wire	127
Arthroscopic Hohman Retractor	73
Arthroscopic Instrumentation	72, 72-73
Arthroscopic Stifle Lever VSTL	61, 72
Arthroscopy Instruments	72-73
Artificial Urethral Sphincter	201
Askir Suction Machine	232
ASYM Plates	93
Atraumatic Small Bowel Clamp	199
Atraumatic Towel Clip	182
Aural Haematoma System (Implants Only)	193
Aural Surgery	193
AUS System	201
A Wires	127

B

Babcock Tissue Forceps	175
Backhaus Towel Clip	182
Balfour Retractor	184, 198
Ball & Socket Towel Clamp	182
Banana Knife - Arthroscopic	72
Bandage Scissors	179
Barraquer Speculum	209
Bar Set - Small (for BOAS Mouth Gag)	191
Bar Sleeve - Silicone (for BOAS Mouth Gag)	191
Basic Surgery Stitch Up Kit	172
Baskets for Premium Instrument Boxes	225
Batteries - Acculan 4	149
Batteries - Black Series	151
Batteries - Vdrive	150
Battery Powered Orthopaedic Drill	155
Battery Powered Saw - Multi Saw	154
Battery Powered TPLO Saw	153
Beaver Type Scalpel Blades	176
Beaver Type Scalpel Handle	176
Bending Levers	38
Bending Templates	134
Bennet's Cilia Forceps	210
Bicortical Negative Threaded Pins	139
Biological Healing Plates	95
Biopsy Forceps - Soft Tissue	192
Biopsy & Grasping Forceps - Malleable	193
Biopsy Needles - Bone/Bone Marrow	27
Biopsy Needles - Soft Tissue	203
Biopsy Punch - Skin	204
Biopsy & Spoon - Arthroscopic	73
Bipolar Cables	231
Bishop Harmon Forceps	210
Bitch Speculum	197
Black Series Power Tools	151-152
Black Series Sterilisation Cases	152, 227
Blades - Acculan 4	149
Blades - Black Series	152
Blades - MiniDriver	157
Blades - Multi Saw	154
Blades - TPLO	35

Blades - Vdrive	150
Blankets - Warm Air System	234
Blood Pressure Cuffs	235
Blunt Dissection Probe	186
BOAS Mouth Gag	191
BOAS Silicone Bar Sleeve	191
BOAS Surgical Kit - Premium	191
BOAS Surgical Kit - Standard	191
Bone/Bone Marrow Biopsy Needles	27
Bone Cement	76, 167
Bone Curette	166
Bone Cutters	14
Bone Graft Products	29
Bone Holding Forceps	9-10
Bone Lever	15
Bone Pin Roll	129
Bone Pin Tubes	129
Bone Plate Contouring	133-134
Bone Plate Holding Forceps	106
Bone Plate Pliers	134
Bone Plate Press	134
Bone Punch Forceps - Low Profile	13
Bone Rasps	66, 70-71
Bone Saws - Handheld	16, 65
Bone Scribe	19
Bone Substitutes	30
Bone Trephine	28
Bone Tunnel Borers	57
Bone Wax	167
Boots	240-241
Bowel Clamps	199
Box Filters	225-226
Brushes for Surgical Instruments	228
Bulla Rongeurs	193
Bulldog Clamps	175
Bungee Gelpi	186
Bur Guards (for Power Tools)	158
Burley Disc Scoop	166
Burs - Dental	219, 222
Burs - Power Tools	159
Bur Stand	159
Bur System - High Speed - Surgairtome	158
Butterfly Plates	100
Buttons - Titanium	59

C

Cage Forceps - TTA	44
Caliper - Vernier	19
Camera Covers - Disposable	73
Cancellous Chips	29
Cancellous Screws	120-121
Canine Ear Loop	193
Cannula Sets - Arthroscopic	73
Cannulated Drill Bits	126
Capnograph	235
Capsule Forceps	210
Carmalt Hysterectomy Clamps	197
Carnivore Elevator	215
Carpal Arthrodesis Plates	101

Carpal Orthotics - Scandi Orthopedic	238
Carpal Supports - Carpo-Flex	241
Carpo-Flex Carpal Supports	241
Castroviejo Corneal Forceps	210
Castroviejo Corneal Scissors	211
Castroviejo Needle Holder	181, 208
Castroviejo Suture Removal Scissors	179, 181
Cats Paw Retractor	183
Cautery Kit - Portable, Cordless	231
CBLO Plates	40
CBLO/TPLO Instrument Set	39
C Drill Guide	132
Cement Restrictor	75
CemtA Cups	75
CemtA Stems	75
Cerclage Button	135
Cerclage Wire	26, 130
Cerclage Wire Passers	25
Chalazion Forceps (Desmarres)	212
Charger - Acculan 4	149
Charger - Battery Powered TPLO Saw	153
Charger - Black Series Drill and Saw	151
Charger - Vdrive	150
Chase Spinal Hook	166
Cheatle Steriliser Forceps	186
Cheek Dilators - Rodent	221
Chisels	18, 215
Cilia Forceps	210
Clamps - External Fixation	140-141
Cleaning Agents for Surgical Instruments	228
Cleaning Brushes for Surgical Instruments	228
Clover Leaf T/TPLO-Plates	36, 98
C-LOX Cervical Intervertebral Fusion - Implants & Equipment	162-163
Cold Compression Therapy Bandage - Scandi Orthopedic	239
Colibri (Barraquers) Forceps	210
Collins Retractor	184
Combi Canine Pantarsal Plates	103
Combination Bone Rasp Set	70
Combination Drill, Tap & Insert Sleeve	132
Combined Screw Sets	83
Combi T-Plates	97
Comfort Handle Elevators	214
Comfort Handle Winged Elevators	214
CompanionPort for Vascular Access	200
Compound Action Crimper	56
Compound Action Crimpers For LigaFiba	53, 56
Compound Action Spinal Rongeurs	13, 164
Compression Plates - 1.0mm	87
Compression Plates - Dynamic	91
Compression T-Plates	96
Condyle Clamp	107
Cone Laminectomy Retractor	165
Conjunctival Scissors	211
Connecting Bars - External Fixation	140-141
Connective Tissue Forceps	182
Corneal Forceps	210
Corneal Scissors	211
Corrective Osteotomy Sawguide System	66
Cortical Negative Threaded Pins (Ellis Type)	138

Cortical Nuts	107, 136
Cortical Plating Kit - 1.0mm	85
Cortical Plating Kits	83, 85
Cortical Screw Sets	83
Cortical Screws - Non Self Tapping	114-115, 115, 117-119
Cortical Screws - Self Tapping- 1.0mm	87
Cortical Screws - Self Tapping - Hex Drive	114-118
Cortical Screws - Self Tapping - Star Drive	114-116
Cortical Screws - Titanium	43
Cortical Taps	123
Cosmetic Surgeon Scissors	178
Cotton Reusable Drapes	229
Countersinks	124
Couplands Elevator	215
Cozy Warm Air System	234
Crile Artery Forceps	174
Crimping Forceps - Lateral Suture	56
Crimps - LigaFiba	53
Crimps - Nylon	55
Crocodile Forceps	193
Cross Action Towel Clips	182
Crossley Incisor Luxator	221
Crossley Molar Luxator	222
Cruciate Drive Screwdrivers	122
Cruciate Needles	55
Cup Biopsy Forceps	192
Curette - Arthroscopic	72
Curette - Bone	166
Curette - Gracey Double Ended	217
Curette - House	166
Curette - OCD	70
Curette - Sheas	167
Curette - Subgingival	216
Curved Forceps - Long	194
Cutable Cage Cutters - TTA	44
Cutable Malleable Locking Plates	90, 94
Cutable Malleable Plates	94
Cutable Plates	94
Cutable Plates - 1.0mm	87
Cutable TTA Cages	42
Cylindrical Sharpening Stone	222, 228

D

Dandy Nerve Hooks	166
Daniel Rongeur	12, 163
Darvall AAS Warm Air System	234
Darvall Capnograph	235
Darvall Express Monitor	235
Darvall HI00N Pulse Oximeter & Temperature Monitor	236
DBM Products	29
DCPs	91-92
DeBakey Atraumatic Dissecting Forceps	183
DeBakey Needle Holders	180
Delta TPLO Plate Benders	133
Demineralised Bone Matrix	29
Dental Burs	219, 222
Dental Chart Labels	219
Dental Elevators	214-215
Dental Forceps	217-218
Dental Forceps For Pin & Wire Extraction	24
Dental Instrument Sharpening Tools	222, 228
Dental Kits - Rabbit & Rodent	220
Dental Luxators	216
Dental Mirrors	218
Dental Scalers	216
Depth Gauges	106, 133
Depth Gauge - TTA Rapid	47
Depth Gauge - TTA Rapid Petite	48
Derf Needle Holder	181, 209
DERMABOND Advanced and Mini Topical Skin Adhesives	171
DERMABOND Prineo Skin Closure System	171
Desmarres Eyelid Retractor	209
Desmarres Forceps	212
DeSoutter Vdrive Power Tools	150
Diamond Card	222, 228
Diamond Cone	222, 228
Diamond Disc & Safety Shield	222
Diamond Rasp - Double Ended	221
Dieffenbach (Bulldog) Clamps	175
Dingmans Forceps	9
Disarticulator	71
Disposable Camera Covers	73
Disposable Drapes	229
Disposable Gowns	229
Disposable Padlocks	226
Disposable Tracheostomy Tubes	191
Dissecting Forceps	182-183
Distichiasis Clamp	212
Distractors - Orthopaedic	19
Divider Type TPLO Rotation Gauge	37
DLPs	88
DocXS Products	200-202
Dorsal Pantarsal Arthrodesis Plates	102
Dorsi-Flex Assist - Hindlimb	241
Double Ended Diamond Rasp	221
Double Ended Elevator	215
Double-Ended Scraper	217
Doyen Bowel Clamp	199
DPO/TPO Plates	67
Drapes - Cotton Reusable	229
Drapes - Disposable	229
Dressing and Support	240-241
Dressing Scissors	178-179
Drill Bits	125-126
Drill Bits - 1.0mm Plating System	87
Drill Bits - Cannulated	126
Drill Bits - External Fixation	139
Drill Bits - Interlocking Nail System	82
Drill Bits - Isotoggle	59
Drill Bits - Quick Release AO Fit	125-126
Drill Bits - Round Shank	125-126
Drill Bits - TTA	43
Drill Bits - TTA Rapid	45
Drill Bits - TTA Rapid Petite	48
Drill Bits - TTA Rapid Tiny	49
Drill Guide - Adjustable	59, 68, 107, 132
Drill Guides & Sleeves	131-132
Drill Guide - TTA Rapid	47
Drill & Screw Gauge	20

Drill Stop Set	126
Duck-Billed Daniel Rongeurs	12, 163
Dynamic Compression Plates	91-92
Dynamic Locking Plates	88
Dynamic Locking Plating Kits	83, 85

E

Ear Flushing Needles	204
Ear Loop	193
Ear Surgery	193
Elbow Arthrodesis Plates	104
Electrosurgery Units	230
Elevators - Dental	214-215
Elevators - Luxating	216
Elevators - Periosteal	215
Ellis Pins	138
End-Thread Pins	138-139
Enema Pump	203
Epilation Forceps	183, 210
Epoxy ESF Putty	142
Equipment Boxes	136, 225-227
Equipment Box - ESF	227
ESF Clamps	140-141
ESF Connecting Bars	140-141
ESF Equipment Box	142, 227
ESF Pin Reference Chart	144-145
ESF Pins	138-139
ESF Tissue Protector	139
Ethicon Suture Range	170-171
Excision Arthroplasty Rasp	71
Explorer/Measuring Probe	216
External Fixation Clamps	140-141
External Fixation Connecting Bars	140-141
External Fixation Pin Reference Chart	144-145
External Fixation Pins	138-139
External Stifle Distractor	72
Extraction Forceps - Dental	217-218
Eyed Wires	26, 130
Eye Enucleation Forceps	212
Eye Enucleation Scissors	211
Eyelid Specula	209

F

Fabella Needles	55
Fat Pad Retractor	62, 183
Feeding Tube Collar	203
Feline Elevator	215
Femoral Head & Neck Excision Arthroplasty	71
FESSA ESF System	143
Filters for Boxes	225-226
Fingered Silicone Insert	226
Finochietto Rib Retractor	184, 194
FitzExcavator Set	165
Fixation Forceps	210
Fixed Shaft Screwdrivers	122
Flushing Needles	204
Foreign Body Retrieval Forceps	195
Forelimb Salvage Plates	104

Forkless Plate Forceps - TTA	44
Forkless TTA Plates	42
Forkless TTA Starter Kit	41
Forte Luxators	216
Foster Gillies Needle Holder	181
Foster Gillies Needle Holder - Miniature	181
Fragment Forceps	8-9
Fragment Forceps - Left Handed	11
Fragment Forceps - Very Large	38
Frazier Suction Tip	232
Freer Periosteal Elevator	15, 166, 215
Friedman Rongeurs	11
Full Pins	138

G

Gag - BOAS	191
Galibans Suture Forceps	181
Gauge for Drills & Screws	20
Gelpi Retractor - Odd Leg	165
Gelpi Retractors	64, 165, 185-186
General Surgery Kit	172
General Surgery Kit - Left Handed Instruments	172
Gigli Wire & Handles	70
Gillies Needle Holders	180
GIMA Bipolar Electrosurgery Unit	230
GIMA Smoke Evacuation Unit	231
Goniometers	70
Gordon Coronoid Osteotome	65, 73
Gosset Retractor	184
Gouges	18
Gowns - Disposable	229
Gracey Double Ended Curette	217
Graefe Fixation Forceps	210
Graefe Iris Forceps	210
Grasping & Biopsy Forceps - Malleable	193
Grays Mouth Gag	218

H

Haemostatic Gel	206
Haemostats	174
Half Pins	138
Halls Surgairtome Bur System	158
Halstead Mosquito Forceps	174
Halstead Mosquito Forceps - Toothed	62
Handheld Retractors	183-184
Handheld Saws	16, 65
Hand Pressure Infusion Cuffs	73
Hanging Limb Prep Stand	28
Hard Back Saw	16, 65
Hard Sole Medipaw Boots	240
Hart Pinna Haematoma System (Implants Only)	193
Hatt Spoons	71
Hauptman Retractors	197
Hawksbill Forceps	217
Heated Anaesthetic Circuits	235
Heath Stitch Scissors	179
Heavy Duty Needle Driver	57
Helica Total Hip Replacement (THR)	74-76

Hepatic Shunt Occluder	202
Hex Driver T Bar Type for TPLO Saw	153
Hex Head Screwdrivers	122
High Speed Bur System - Surgairtome	158
Hindlimb Dorsi-Flex Assist	241
Hindlimb Salvage Plates	104
Hip Fixation and Navigation Device - THR	76
Hip Replacement Equipment & Implants	74-76
Hip Toggling	68
Hobdays Obstetric Forceps	197
Hoe Periosteal	216
Hoe Scaler	217
Hohman Retractor - Arthroscopic	73
Hohman Retractors	69-70, 73-74
Hook Knife	61
Hook Knife - Arthroscopic	72
Hook Probe - Arthroscopic	72
Horsley Bone Cutters	14
Hose - Halls (for Surgairtome)	158
Hose - MiniDriver	157
Hospivac Spares	232
House Curette	166
Howard 'B' Ovariohysterectomy Clamp	197
Howarth Dissector	15
HSO System	202
Huber Needles	202
Hybrid Anatomical T-Plates	98
Hybrid T-Plates	98
Hysterectomy Clamps - Carmault	197

I

Ikuta Bone Clamps	8
Imperial Ruler	20
IM Pin Box	129
IM Pin Punch	16
IM Pins	128
Implant Cutters	21-23
Implant Selection Chart	86
Incise Drapes	229
Incisor Forceps	217
Incisor Luxator - Crossley	221
Infusion Cuffs - Arthroscopic	73
Infusion Needle - Intraosseous	204
Inlay options for Screw Cup	75
Insert Sleeves	131
Instrument Boxes	225-227
Instrument Cleaning Agents	228
Instrument Cleaning Brushes	228
Instrument Kit - Basic Surgery Stitch Up	172
Instrument Kit - General Surgery	172
Instrument Kit - Left Handed	172
Instrument Kit - Ophthalmic	208
Instrument Kits - BOAS Surgery	191
Instrument Kits - Rabbit & Rodent Dentistry	220
Instrument Marking Tape	228
Instrument Trays - Modular Plating Box	84, 224
Interference Screw - Isotoggle	59
Interlocking Nail System - Drill Bits	82
Interlocking Nail System (ILN)	79-82

Interlocking Nail System - Instrument & Implant Sets	79
Interlocking Nail System - Locking Screws & Bolts	81
Interlocking Nail System - Nails	80
Intervertebral Instrument Set	165
Intra-Medullary Pins	128
Intraosseous Infusion Needle	28, 204
Iodine-Impregnated Drapes	229
Iris Forceps	210
Iris Scissors	211
Isotoggle	59
Isotoggle Drill Bits	59
Isotoggle Interference Screw	59

J

Jacobs Chuck - Handheld	25
Jaeger Eyelid Speculum	209
Jamshidi Biopsy Needles	27, 204
Jansen Rongeurs	12
Jaquette Scaler	167
Jaquette Supraperiosteal Scaler	216
Jigs - TPLO	37
Joint Distractors	63
Jones Towel Clip	182

K

K110 Small Jacobs Chuck (MiniDriver)	156
K111 Wire Driver (MiniDriver)	156
K211 Pin Driver (MiniDriver)	156
K/A Wire Bender	16
K/A Wire Dispenser	129
K/A Wire Holders	129
K/A Wire/Pin Punches	16
K/A Wire Remover	24
Kelly Forceps	174
KE Plus ESF System	141
Kern Bone Holding Forceps	10
Killian Bitch Speculum	197
Kilner Needle Holders	181
Kimura Spatula	212
Kirschner and Arthrodesis Wire Remover	24
Kirschner Wire	127
Kitty Kollar Tube Collar	203
Kocher Artery Forceps	174
K Wires	127
K Wires - TTA Rapid	45

L

Labels for Premium Instrument Boxes	225
Lachrymal Cannulae	212
Laminectomy Rongeurs	164
Langenbeck Retractor	183
Large Angled Cutters	14
Large Twin Point Reduction Forceps With Spinlock	9
Lateral Button Suture	58-59
Lateral Suture	52-57
Lateral Suture - Crimping Forceps	53, 56

Lateral Suture - LigaFiba	53
Lateral Suture - Nylon	54-55
Lateral Suture Starter Kits	52
Lateral Suture - Tensioning Devices	56
Leader Line	54-55
LED Light For Table Top Rabbit Gag	220
Left Handed Instruments	11, 172-173, 187-188
Left Handed Instruments - General Surgery Kit	172
Left Handed Instruments - Spay Kits	173
Left Handed Instruments - Starter Kit	172, 187
LeiLOX 1.5/2.0 Micro Locking System	105-106
LeiLOX CBLO Locking System	39-40
LeiLOX Instrumentation for Locking Plates	105-106
LeiLOX Locking Screws	40, 105-106
LeiLOX Non-Locking Screws	40
LeiLOX Screwdriver	106
Lempert Straight Rongeurs	11, 164
Lesser Wire Passer/Retrieval Forceps	25
Lever Spreader - TTA Rapid	47
LigaFiba Compound Action Crimpers	53
LigaFiba Crimps	53
LigaFiba Hip Toggles	68
LigaFiba Isotoggle	59
LigaFiba Lateral Button Suture	58
LigaFiba Lateral Sutures	53
LigaFiba Scissors	53, 57
LigaFiba Tendon & Ligament Sutures	60
Ligament/Cartilage Clamp	62
Light Pattern Chisels	18
Light Pattern Osteotome	17
Limb Salvage Plates	104
Limb Support - Multi Arm	28
Lip Retractor	218
Lister Bandage Scissors	179
Lister Speculum	209
Liston Bone Cutters	14
Littauer Stitch Scissors	179
Load Neutral Drill Guides	131
Locking Drill Guides	67, 106, 132
Locking Plates - Cuttable Malleable	90
Locking Plates - Dynamic Locking	88
Locking Plates - LeiLOX	105-106
Locking Plates - Pancarpal Arthrodesis	101
Locking Plates - Stacked Hole	89
Locking Plates - Supracondylar	99
Locking Plates - TPLO	35
Locking Plates - TPO/DPO	67
Locking Plating Kits	83, 85
Locking Plugs	113
Locking Screw Drill Guides	131
Locking Screws	112-113
Locking Screw Sets	83, 85, 113
Locking Screws - LeiLOX	40, 105-106
Locking Taps	123
Locking T-Plates	96
Locking TPLO Starter Kits	33, 34
Locking Wire Guide	131
LokRod Plates	90
Lowman Bone Clamp	10
L/R Xray Marker With Scale	20

L-Shaped Saw Guide - TTA Rapid	46, 48-49
Luxating Elevators	216
Luxators - Dental	216
Lyostypt	167, 206

M

Malleable Grasping & Biopsy Forceps	193
Malleable Instrument Set	193
Malleable Orthopaedic Wire	26, 130
Malleable (Walton) Retractors	184
Mallet - Orthopaedic	18
Mallet - Percussion	163
Mallet - TTA	44
Mayo Hegar Needle Holder	180
Mayo Needle Holder	180
Mayo Safety Pin	175
Mayo Scissors	177-178
McIndoe Bone Cutters	14
McKee Distractor with Speedlock	165
McPhails Needle Holder	180
Medial Pantarsal Arthrodesis Plates	102-103
Medical Protection Cover - Scandi Orthopedic	239
Medipaw Protective Boots	240-241
Medipaw Slim Boots	240
Meniscectomy Instruments	62
Meniscus Probes	61
Meniscus Surgery Instruments	60-62
Meniscus Surgery Sets	60
Mesh - Polyester	203
Mesh - Titanium	107
Metric Ruler	20
Metzenbaum Scissors	177-178
Micro-Friedman Rongeurs	11, 164
Micro Scissors	191
Micro Spine Rongeur Set	12, 163
Mid-Thread Pins	138
Milling Drill - Hand-Driven	73
Miniature Foster Gillies Needle Holder	181, 209
MiniDriver & Attachments	156-157
Mini Friedman Rongeurs	11, 164
MIPO Minimally Invasive Plate Osteosynthesis Elevator	15
Modular Countersinks	124
Modular Osteotome	17, 65
Modular Plating Box - Components	84, 224
Modular Plating Box Kits	83
Modular Screwdrivers	122
Molar Cutter - Rodent	221
Molar Extraction Forceps	222
Molar Luxator - Crossley	222
Molar Rasp - Rodent	221
Molt Periosteal Elevator	15, 215
Monitors	235-236
Monopolar Electrodes	231
Monopolar Handles	231
Monopolar Unit	230
Morris Retractor	183
Mosquito Forceps	174
Mouth Gag - BOAS	191
Mouth Gags - Rodent/Rabbit	221

Mouth Gags & Wedges - Canine/Feline	218
Multi Arm With Limb Brace Attachment	28
Multiparameter Monitor	235
Multi Saw Battery Powered Saw	154

N

NanoPaste	30
Nasolachrymal Duct Cannulae	212
Needle Boxes	227
Needle Holders	180-181, 208-209
Needle Holders - Left Handed	188
Needles - Biopsy	203
Needles - Ear Flushing	204
Needles - Flushing	204
Needles - Oral Dosing	204
Needles - Spinal	167
Needles - Spreulls	204
Negative Pressure Wound Therapy	205
Negus Forceps	174, 192
Non-Locking Screws (LeiLOX)	40
Norfolk Vet Products	200-202
Nylon Lateral Button Suture	59
Nylon Lateral Suture	54-55

O

Obstetric Forceps	197
OCD Curette	70
Odd Leg Gelpi Retractor	165
Odd Leg Spike and Shield Retractor	165
Oesophagostomy Tube Collar	203
Offset K/A Wire Punch For Bent Pins	16
Offset Wire Bender	16
Olsen Hegar Needle Holder	180
Ophthalmic Forceps	210
Ophthalmic Kit	208
Ophthalmic Scissors	211
Oral Dosing Needles	204
Orthopaedic Distractor	19
Orthopaedic Drill - Battery Powered	155
Orthopaedic Hard Back Saw	16, 65
Orthopaedic Mallet	18
Orthopaedic Starter Kit - Enhanced	7
Orthopaedic Starter Kit - Standard	6
Orthopaedic Wire	26, 130
Orthopaedic Wire Kit	26, 130
Osteophyte Rasp	66
Osteotome - Gordon Coronoid	65
Osteotomes	17, 65
Ovariohysterectomy	196-197
Ovariohysterectomy Clamp - Howard 'B'	197

P

Padlocks - Disposable	226
Pancarpal Arthrodesis Plates - DCP Style	101
Pancarpal Arthrodesis Plates - Locking	101
Pantarsal Arthrodesis Plates	102-103

Parallel Action Pliers	24
Partial Carpal Arthrodesis Plates	101
Partial Tarsal Arthrodesis Plates	102
Patellar Luxation Instrumentation	65
Patellar Luxation Plate - Titanium	50
Patellar Luxation Spacers	50
Patella Saw	16, 65
Patient Monitoring	235-236
Patient Warming	234-235
Penrose Drains	203
Percussion Mallet	163
Periodontal Instruments	216
Periosteal Elevators	15, 166, 215
Periotome - Hoe	216
Petite TTA Rapid	48
Pet Lift Sling - Scandi Orthopedic	239
Pin Cutters	21-23, 139
Pin Grip	24
Pinna Haematoma System (Implants Only)	193
Pin Punches	16
Pin Reference Chart	144-145
Pins - External Fixation	138-139
Pins & Wires	127-129
Pin Vice	24
Pin & Wire Extraction	24
Pin & Wire Storage	129
Pipe Cleaners	228
Plaster Cutting	27
Plaster Shears Stille	27
Plaster Spreaders	27
Plate Bending Levers	133
Plate Bending Pliers	134
Plate Contouring Devices	133-134
Plate Holding Clip	135
Plate Holding/Drill Guide Forceps	10, 38, 47
Plate Holding Forceps	11
Plate Pliers	134
Plate Press	134
Plate Selection Chart	86
Plate Trays - Modular Plating Box	84, 224
Plating Kit - 1.0mm	85
Plating Kits - Cortical	83, 85
Plating Kits - Locking	83, 85
Pleural Port	200
Pliers - Parallel Action	24
Pliers - Plate Bending	134
Pointed Reduction Forceps	8
Polyester Mesh	203
Poole Suction Tip	232
Pooley's Conjunctival Scissors	211
Portable Cordless Cautery Kit	231
Positive Threaded Pins - Cancellous	138
Positive Threaded Pins - Cortical	138
Power Tool Lubricants	149, 158
Pre-Drilling ESF Pin Tracts	139
Pre-Drills for ESF Pins	126
Premium Depth Gauges	133
Premium Instrument Boxes	225
Premium TTA Case	41
Protective Autoclavable Tips	229

Protective Boots	240-241
Protractor for TPLO Blades	153
Puddle Vac	73
Pulse Oximeter & Temperature Monitor	236
Punches & Rongeurs	163-164
Punch Forceps	164
Punctum Dilator	212
Push Knife	61

Q

Quick Release AO Fit Drill Bits	125-126
Quick Release Handles	122-124

R

Rabbit Gag	220
Rabbit Nasolachrymal Duct Cannulae	212
Rabbit/Rodent Bur Kit	222
Rabbit & Rodent Dental Kits	220
Radiographic L/R Marker With Scale	20
Radiographic Reference Ball	20
Rain Cover - Scandi Orthopedic	239
Ramplays Sponge Forceps	175
Rapidex	228
Rapid Luxation Plating System	50
Rapizyme	228
Rasp - Combination Bone Rasp	70
Rasp - Excision Arthroplasty	71
Rasp - Osteophyte	66
Rasps - Dental	221
Rasps - Orthopaedic	66, 70-71
Rasps - Patellar Luxation	66
Rat Tooth Forceps	182
Rectangular Sulcoplasty Instruments	66
Reduction Forceps Serrated Jaws	9
Reduction Forceps With Hard Wire Guide	8
Reduction Forceps With Spinlock	47
Resano Bowel Clamp	199
Retractors - Abdominal	184
Retractors & Distractors	165
Retractors - Gelpi	165, 185-186
Retractors - Skin/Superficial	185
Retractor - TECA	193
Rib Retractor - Finochietto	184, 194
Right Angled Clamps	194
Ring Curette - Arthroscopic	72
Ring Retractor	184, 198
Roberts Tying Forceps	209
Rochester Pean Artery Forceps	174
Rodent Cheek Dilators	221
Rodent Molar Cutter	221
Rodent Molar Rasp	221
Rodent Mouth Gag	221
Rodent/Rabbit Bur Kit	222
Rodent Spatula	221
Rongeur & Grasping Forceps - Arthroscopic	73
Rongeurs	11-12, 163-164, 193
Rongeurs & Punches	163-164
Ronguers	64

Root Fragment Set	218
Root Tip Extraction Forceps	222
Rosen Mobiliser	166
Rosenthal Biopsy Needle	27
Rotation Chart - TPLO	38
Round Hole Plates	95
Round Hole T-Plates	98
Round Shank Drill Bits	125-126
Rulers	20
Ruskin Bone Cutters	14
Ruskin Rongeurs	12
Ryder Needle Holders	181, 209

S

Safety Implant/Pin Cutter	139
Satinsky Clamp	192
Saw Blades - TPLO	35
Saw Guide - TTA	44
Saws - Handheld	16, 65
Scalers - Handheld	217
Scalpel Blades & Handles	176
Scandi Orthopedics	238-239
Schroeder Tenaculum	9
Scissors - Dressing	178-179
Scissors - General Surgical	177-179
Scissors - Left Handed	187
Scissors - LigaFiba	53, 57
Scissors - Micro	191
Scissors - Ophthalmic	211
SCOP Plates	99
Scratch Pad	231
Screw Boxes	84, 136, 224, 227
Screwbox For Titanium TTA Screws	43
Screw Caddies - Modular Plating Box	84, 224
Screwdriver Handle - Silicone	40
Screwdriver Inserts - TTA Rapid	47
Screwdriver (LeiLOX)	40, 106
Screwdrivers	122
Screwdriver & Screw Identification Aids	108-111
Screwdrivers - Fixed Shaft	122
Screwdriver Shaft Star Drive	40, 49
Screwdrivers - Modular	122
Screwdriver - TTA Rapid Petite	48
Screwdriver - TTA Rapid Tiny	49
Screw Extraction Trephine	136
Screw Holding Forceps	135
Screw Identification Resources	108-111
Screws - 1.5mm	114
Screws - 2.0mm	114-115
Screws - 2.4mm	115
Screws - 2.7mm	116
Screws - 3.5mm	116-117
Screws - 4.5mm	118
Screws - 5.5mm	119
Screws - Cancellous	120-121
Screws - Cortical Non Self Tapping	114-119
Screws - Cortical Self Tapping - Hex Drive	114-119
Screws - Cortical Self Tapping - Star Drive	114-116
Screw & Screwdriver Identification Aids	108-111

Screw Sets - Combined	83	Spinal Needles	167
Screw Sets - Cortical	83	Spinal Rongeurs	164
Screw Sets - Locking	83, 85, 112	Spinal Rongeurs - Compound Action	164
Screws - Locking	112-113	Splints - Padded & Thermoplastic	241
Self Centering Bone Holding Forceps	10	Sponge Forceps	175
Senn (Cats Paw) Retractor	62, 183	Spreulls Needles	204
Serrated Block End Dissecting Forceps	182	Stacked Hole Locking Plates	89
Shaft Screws	107	Standard Fixator ESF System	140
Shardel Towel Clip	182	Staples - Skin	205, 229
Sharpening Stone	222, 228	Star Drive Screwdrivers	122
Sharpening Tools for Dental Instruments	222, 228	Starter Kit - Canine Spay	196
Sheas Curette	167	Starter Kit - Feline Spay	196
Shepherd's Crook Explorer Probe	216	Starter Kit - Heated Anaesthetic Circuits	235
Shoulder Aiming Device - Arthroscopic	73	Starter Kit - Left Handed Instruments	172, 187
Shroud - Multi Saw	154	Starter Kit - Ophthalmic	208
Shroud - Orthopaedic Drill	155	Starter Kit - Orthopaedic - Enhanced	7
Silicone Insert	226	Starter Kit - Orthopaedic - Standard	6
Skin Biopsy Punch	204	Starter Kits - BOAS Surgery	191
Skin Marker	186	Starter Kits - Lateral Button Suture	58
Skin Staple Remover	205, 229	Starter Kits - Lateral Suture	52
Skin Staplers	205, 229	Starter Kits - LigaFiba Lateral Button Suture	58
Slocum Rotation Gauges	37	Starter Kits - Locking TPLO	33-34
Slocum Style TPLO Jig	37	Starter Kits - Rabbit & Rodent Dentistry	220
Slocum Style TPLO Plates	36	Starter Kits - TPLO	33-34
Slocum TPLO Guide Pin	37	Starter Kit - Thoracic Surgery	194
Small Angled Cutters	14	Starter Kit - TTA (Forkless)	41
Small Bar Set for BOAS Mouth Gag	191	Starter Kit - TTA Rapid	45
Small Curved Rongeurs	11	Starter Kit - TTA Rapid Tiny	49
Small Curved Serrated Reduction Forceps	9	Starter Kit - TTA (Standard)	41
Small Distractor With Ratchet	19	Starter Kit - Warm Air Unit	234
Small Pin Punch	16	Steinman Intra-Medullary Pins	128
Small Pin Vice	24	Sterile Hooks	184, 198
Small Serrated Bone Holding Forceps	9	Sterile Skin Marker	186
Small Stifle Ronguers	64	Sterilisation Cases - Black Series	152, 227
Smilie Knife - Arthroscopic	72	Steven's Tenotomy Scissors	211
Smith Baxter Mouth Gag	218	Stifle Distractor - External	72
Smith-Kerrison Punch Forceps	13, 164	Stifle Distractors	63
Smoke Evacuation Unit	231	Stifle Levers	61
Snellen's Vectis	212	Stille-Luer Rongeurs	12, 164
Soft Edge Surgical Spoon	199	Stille Plaster Shears	27
Soft Palate Clamp	192	Stitch Scissors	179
Soft Sole Medipaw Boots	240	Stitch Up Kit	172
Soft Tissue Biopsy Forceps	192	St Martins Corneal Forceps	210
Soft Tissue Biopsy Needles	203	St Martins Dissecting Forceps	183
Spacers - TTA	43	Stomach Tubes	205
Spanners	142	Strabismus Scissors	211
Spatula - Ophthalmic	212	Strong Cerclage Wire Passers	25
Spatula - Rodent	221	Stubby Osteotome	17
Spay Forceps	196	Stubby Punch	16
Spay Hooks	196	Subcutaneous Ureteral ByPass System	201
Spay Kit - Canine	196	Subcutaneous Ureteral ByPass System - Flush Kit	202
Spay Kit - Feline	196	SUB Flush Kit	202
Spay Kits - Left Handed Instruments	173	Subgingival Curette	216
Spay Surgery	196-197	SUB System	201
Specula - Eyelid	209	Suction Machine	232
Specula - Obstetric	197	Suction Tips	232
Spencer Wells Artery Forceps	174	Suction Tubing & Connectors	232
Spike and Shield Odd Leg Retractor	165	Superfine Elevator	215
Spikey Washers	135	Supracondylar Locking Plates	99
Spinal Distractors	165	Supracondylar Osteotomy Plates (SCOP)	99

Supracondylar Plates	99
Supraringival Scaler - Jaquette	216
Surgairtome Bur System	158
Surgery Kits - Meniscus	60
Surgical Scissors	177-179
Surgical Skin Marker	186
Surgical Spoon - Soft Edge	199
Surg'X Instrument & Implant Sets	79
Surg'X Interlocking Nail System (ILN)	79-82
Suture Anchor Pins	60
Suture Screws	60
Swann Morton Scalpel Blades	176
Swann Morton Scalpel Handles	176
Swedish Pattern Chisel	18
Swedish Pattern Osteotome	17

T

Table Top Rabbit Gag	220
Table Top Stand For Hanging Limb Prep.	28
Tap Devices	123
Tarsal Arthrodesis Plates	102-103
Tarsal Orthotics - Scandi Orthopedic	238
Tarsal Supports - Tarso-Flex X	241
Tarso-Flex X Tarsal Supports	241
Tartar Forceps	217
Tartar Scrapers	217-218
T Bar Countersinks	124
T Bar Taps	123
TECA Retractor	193
Temno Evolution Biopsy Needle	203
Temperature Monitor & Pulse Oximeter	236
Tendon & Ligament Sutures - LigaFiba	60
Tenotomy Scissors	211
Tensioning Devices - Lateral Suture	56
Tetra-EDTA Flush	202
T-FloLoc	202
Thera-Paw Boots	240
Thermoplastic Splinting	241
Thoracic Surgery	194-195
Thoracic Surgery Kit	194
THR	74-76
Threaded Pins & Wires	128
Tibial Tappet - TTA Rapid	50
Tibial Tuberosity Advancement (TTA)	41
Tiny TTA Rapid	49
Tiny TTA Rapid Cages	49
Tiny TTA Rapid Drill Bits	49
Tiny TTAR Spreader	48
Tissue Forceps	175
Tissue Protection Sleeves	131
Tissue Protector - ESF	139
Titanium Buttons	59,68
Titanium Cortical Screws (TTA)	43
Titanium Cortical Screws (TTA Rapid)	46,48-49
Titanium Mesh System	107
Tongue Forceps - Youngs	175
Tonsillectomy Clamp	192
Toothed Halstead Mosquito Forceps	62
Total Hip Replacement	74-76
Towel Clips	182
T-Plates	96
T-Plates - 1.0mm	87
T-Plates - Clover Leaf	98
T-Plates - Combi	97
T-Plates - Compression	96
T-Plates - Hybrid	98
T-Plates - Hybrid Anatomical	98
T-Plates - Locking	96
T-Plates - Round Hole	98
TPLO/CBLO Instrument Set	39
TPLO Guide Pins	37
TPLO Instrument Trays - Modular Plating Box	84,224
TPLO Jigs	37
TPLO Plates	35-36
TPLO Reduction Forceps With Wire Guide	38
TPLO Rotation Chart	38
TPLO Rotation Gauge (Divider Type)	37
TPLO Rotation Gauges	37
TPLO Saw Blade Protractor	37,153
TPLO Saw Blades	35
TPLO Saw Hex Driver T Bar Type	153
TPLO Saws	149-150,153
TPLO Starter Kits	33,34
TPLO Starter Kits - Locking	33-34
TPO/DPO Plates	67
Tracheostomy Tubes - Disposable	191
Travers Retractor	185
Trephine - Bone	19
Trephine - Screw Extraction	136
Treves Rat Tooth Forceps	182
Triple Drill Guides	132
Triple Tibial Osteotomy - Plates & Equipment	51
Trochar Pins	138
Trochlea Rasp	66
Tru-Cut Biopsy Needles	203
TTA Cage Forceps	44
TTA Cages	42
TTA Case - Premium	41
TTA Cuttable Cage Cutters	44
TTA Cuttable Cages	42
TTA Drill Bits	43
TTA Forkless Plate Forceps	44
TTA Forks	42
TTA Instrumentation	44
TTA Mallet	44
TTA Plates (Forkless)	42
TTA Plates (Standard)	42
TTA Rapid 1.5mm Titanium Screws - Tiny - Star Drive	49
TTA Rapid 2.0mm Titanium Screws - Petite - Hex Head	48
TTA Rapid 2.0mm Titanium Screws - Tiny/Petite - Star Drive	49
TTA Rapid 2.4mm Titanium Screws - Hex Head	46
TTA Rapid Accessories	45
TTA Rapid Acetate	46
TTA Rapid Bending Iron	46
TTA Rapid Cages - Petite	48
TTA Rapid Cages - Standard	46
TTA Rapid Cages - Tiny	49
TTA Rapid Depth Gauge	47
TTA Rapid Drill Bits	45

TTA Rapid Drill Guide	47
TTA Rapid Drill Sleeve Guide	47
TTA Rapid Implant Tray	45
TTA Rapid Instrument Tray	45
TTA Rapid K Wires	45
TTA Rapid Lever Spreader	47
TTA Rapid L-Shaped Guide	46
TTA Rapid L-Shaped Petite Saw Guide	48
TTA Rapid L Shape Saw Guide For Tiny Cages	49
TTA Rapid Luxation Plating System	50
TTA Rapid Patellar Luxation Spacers	50
TTA Rapid Petite	48
TTA Rapid Petite Depth Gauge	48
TTA Rapid Petite Screwdriver Insert & Sleeve	48
TTA Rapid Petite Twist Drill	48
TTA Rapid Plate Holding Forceps	47
TTA Rapid Premium Instrument Kit	45
TTA Rapid Saw Guide Pin	46
TTA Rapid Screwdriver Handle	47
TTA Rapid Screwdriver Inserts	47
TTA Rapid Screw Rack	45
TTA Rapid Screws 2.0mm Titanium - Hex Head	48
TTA Rapid Spreader - Tiny	48
TTA Rapid Star Drive 1.5mm Screw Titanium	49
TTA Rapid Star Drive 2.0mm Screw Titanium	49
TTA Rapid Starter Kit	45
TTA Rapid Tibial Tappet	50
TTA Rapid - Tiny	49
TTA Rapid Tiny Starter Kit	49
TTA Rapid Tray with Lid	45
TTA Rapid Universal Spreader	47
TTA Saw Guide	44
TTA Screwbox	43
TTA Screws	43
TTA Spacers	43
TTA Spinlock Reduction Forceps	44
TTA Starter Kits	41
TTA Washers	43
TTO Plates & Equipment	51
Twin Point Fragment Forceps	8
Twist Drills	49
Tying Forceps - Roberts	209

U

Universal Drill Guides	131
Universal Spreader - TTA Rapid	47
Universal Sulcoplasty Rasp	66

V

V.A.C. Therapy Unit	205
Variable Speed Orthopaedic Drill	155
Vascular Access - CompanionPort	200
Vascular Probe Set	198
Vdrive Power Tools	150
Vernier Caliper	19
Veterinary Tissue Bank Products	29
Vetigel & Vetigel Accessory Packs	168, 206
VILTPO Locking TPLO Plates	35

Volkman Bone Scoop	18
VSTL Stifle Lever	61, 72

W

Walton Retractors	184
Warm Air System - Unit & Blankets	234
Washers	135
Washers - TTA	43
Waterproof Shroud - Multi Saw	154
Waterproof Shroud - Orthopaedic Drill	155
Webb Bolts	135
Wedge Elevator	215
Wedge Osteotomy Gauge Set	38
Weislander Retractor	185
West Retractor	185
Whelping Forceps	197
Winged Director	186
Winged Elevators	214
Wire Benders	16
Wire Contouring Pliers	24
Wire Kit	26, 130
Wire Passer/Retrieval Forceps	25
Wire Passers	25
Wire & Pin Extraction	24
Wire & Pin Storage	129
Wire Remover	24
Wires & Pins	127-130
Wires with Eyelet	26, 130
Wire Tighteners	26, 130
Wire Twister and Shear Cutter	26, 130
Wound Therapy - Negative Pressure	205

X

Xray Marker With Scale	20
------------------------	----

Y

Yankauer Suction Tip	232
Younger Good Scaler	167
Youngs Tongue Forceps	175



Veterinary
Instrumentation

Left Handed Instruments

Vi offer a selection of left handed instruments, identified by one black handle.



View the full range on Page 187

Veterinary Instrumentation

Distinction House, 26 Atlas Way, Sheffield, UK, S4 7QQ

☎ +44 (0)114 258 8530

✉ info@vetinst.com

🌐 www.veterinary-instrumentation.co.uk



@Veterinary Instrumentation



CATUK2025